

# City Of Columbus

## Department of Public Service

### Internal ADA Workshop 2023



# Presentation Overview

- Why have to comply with ADA
- Scoping
- Design Basics
  - Components
  - Intersection design
  - Best Practices
- Pushbuttons
- Construction inspection

# Why ADA?

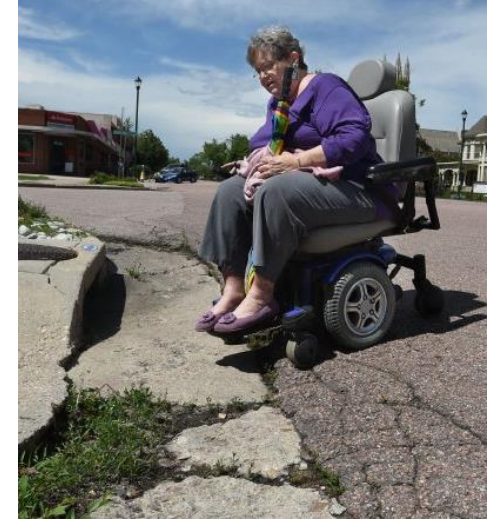

# ADA is a civil right

- The Americans with Disabilities Act (ADA) was signed into law on July 26, 1990, by President George H.W. Bush.
- Modeled after the Civil Rights Act of 1964, which prohibits discrimination on the basis of race, color, religion, sex, or national origin – and Section 504 of the Rehabilitation Act of 1973 -- the ADA is an "equal opportunity" law for people with disabilities.



# Equal Access

- The ADA is one of America's most comprehensive pieces of civil rights legislation that prohibits discrimination and guarantees that people with disabilities have the same opportunities as everyone else to participate in the mainstream of American life -- to enjoy employment opportunities, to purchase goods and services, and to participate in State and local government programs and services.

## **ADA in the ROW rule of Thumb:**

- **If an able bodied person has access to a facility, a disabled person should also be provided access.**



# Disabilities affect 57 Million Americans

## American Disabilities

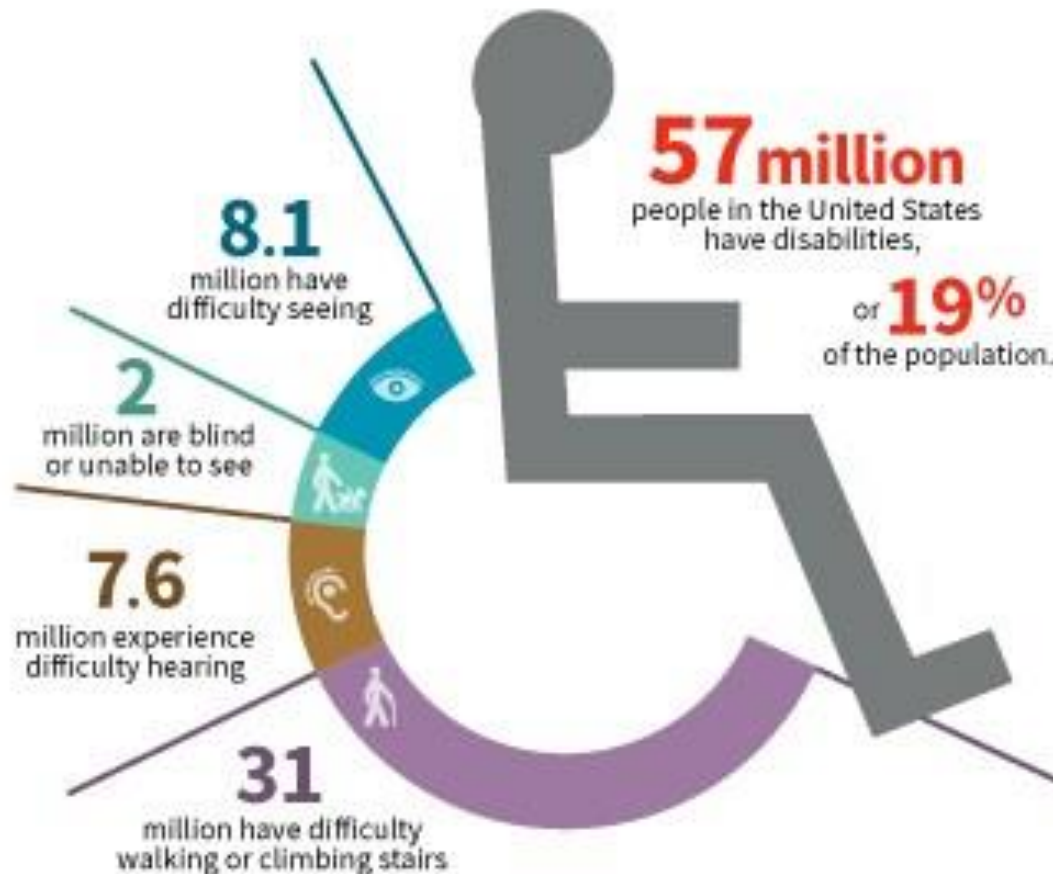

# COC ADA Guidance

**CITY OF COLUMBUS, OHIO  
ADA RULES AND REGULATIONS**



Effective April 1, 2018

[Columbus DPS ADA webpage](#)

# Federal Guidance

City of Columbus ADA Rules and Regulations are based off of Federal Guidance:

## Hierarchy of ADA Reference Documents

1. DOJ's 2010 ADA Standards for Accessible Design
2. PROWAG
3. OMUTCD

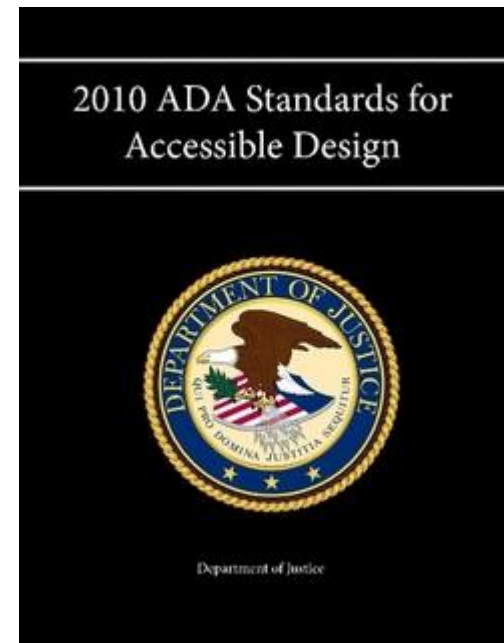
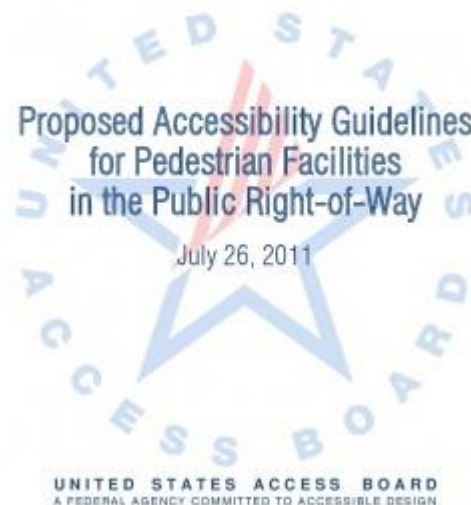
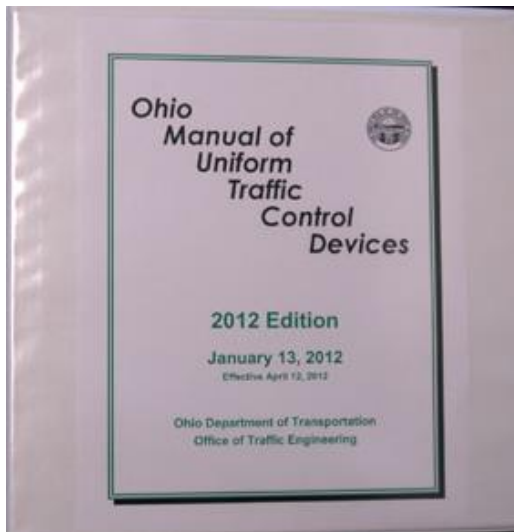



# ADA Scoping

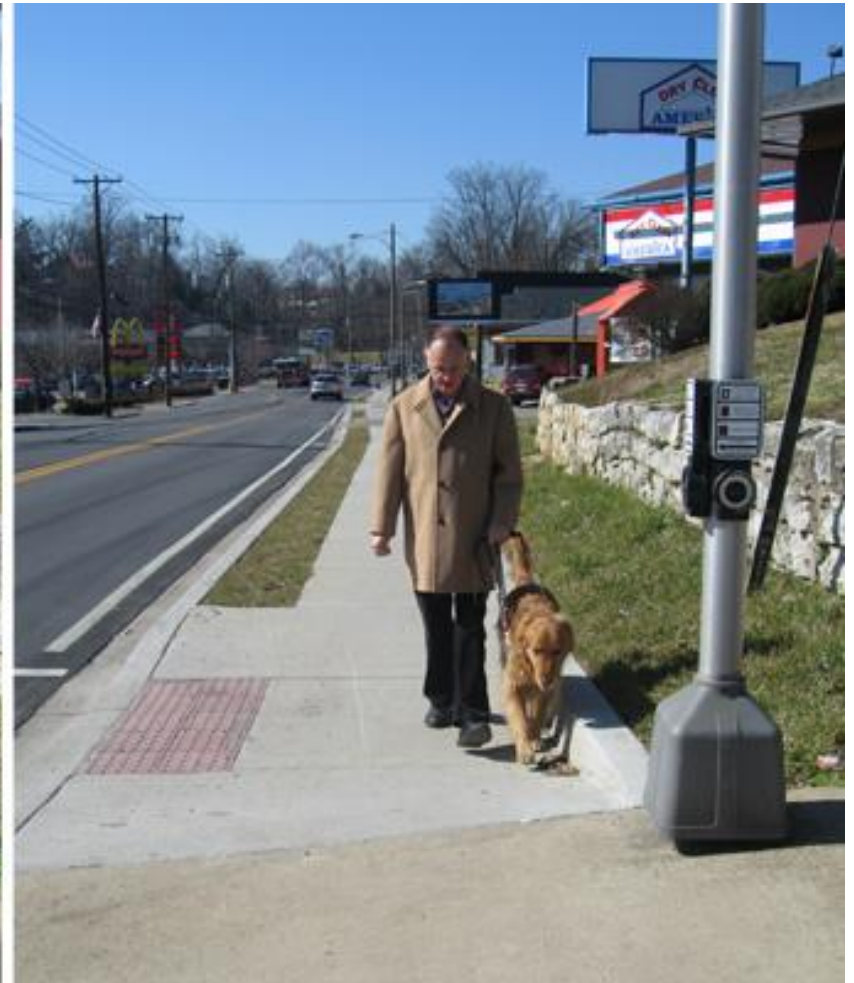

# ADA Scoping

- **New Construction** – a brand new roadway or complete removal and replacement of a roadway without existing constraints. *Subject to 100% ADA compliance*



# ADA Scoping

- **Alteration** – 98%+ of City projects where existing constraints will affect what can be constructed and the scope of work is limited. More specific rules on what is required for ADA.

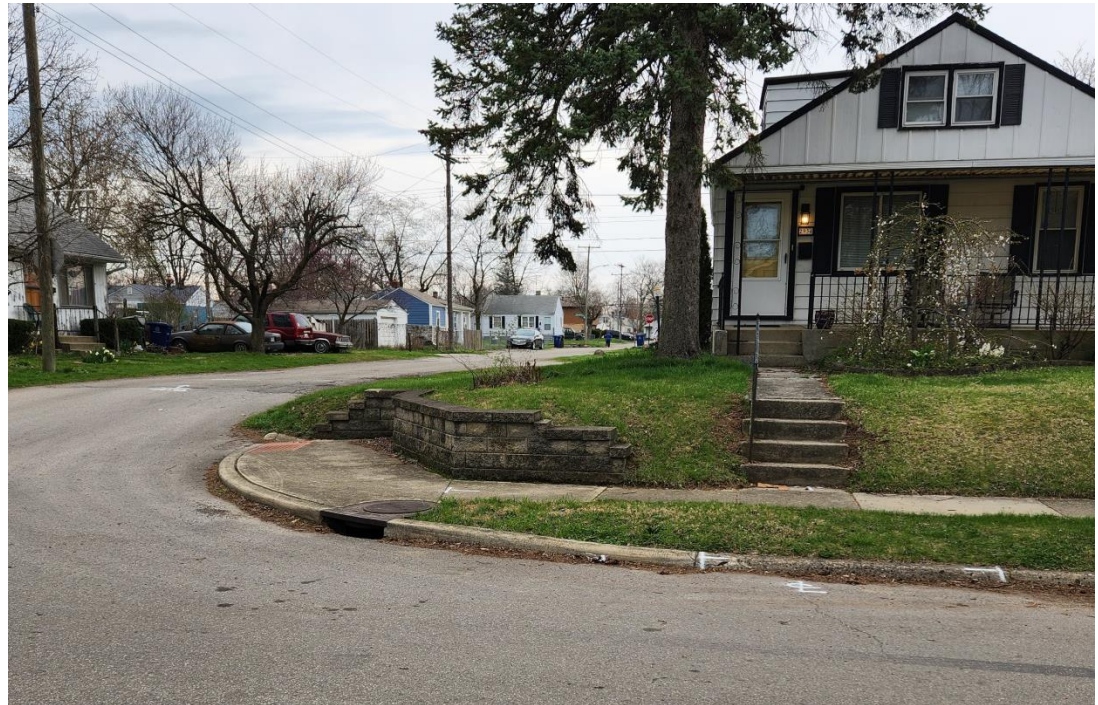

# ADA Scoping

## Project Type

- Resurfacing
  - The most common trigger for ADA compliance



# ADA Scoping

## Project Type

- Resurfacing
  - Curb to Curb resurfacing from intersection to intersection will trigger Curb ramps
  - Any width of resurfacing adjacent to a curb within the legal crosswalk will trigger Curb Ramps



# ADA Scoping

## Project Type

- ADA responsibilities related to resurfacing are based on a DOJ/DOT Joint Technical Assistance document <https://www.ada.gov/doj-fhwa-ta.htm>



U.S. Department of Justice  
Civil Rights Division  
Disability Rights Section



U.S. Department of Transportation  
Federal Highway Administration

### Department of Justice/Department of Transportation Joint Technical Assistance<sup>1</sup> on the Title II of the Americans with Disabilities Act Requirements to Provide Curb Ramps when Streets, Roads, or Highways are Altered through Resurfacing

Title II of the Americans with Disabilities Act (ADA) requires that state and local governments ensure that persons with disabilities have access to the pedestrian routes in the public right of way. An important part of this requirement is the obligation whenever streets, roadways, or highways are *altered* to provide curb ramps where street level pedestrian walkways cross curbs.<sup>2</sup> This requirement is intended to ensure the accessibility and usability of the pedestrian walkway for persons with disabilities.

An alteration is a change that affects or could affect the usability of all or part of a building or facility.<sup>2</sup> Alterations of streets, roads, or highways include activities such as reconstruction, rehabilitation, *resurfacing*, widening, and projects of similar scale and effect.<sup>2</sup> Maintenance activities on streets, roads, or highways, such as filling potholes, are not alterations.

Without curb ramps, sidewalk travel in urban areas can be dangerous, difficult, or even impossible for people who use wheelchairs, scooters, and other mobility devices. Curb ramps allow people with mobility disabilities to gain access to the sidewalks and to pass through center islands in streets. Otherwise, these individuals are forced to travel in streets and roadways and are put in danger or are prevented from reaching their destination; some people with disabilities may simply choose not to take this risk and will not venture out of their homes or communities.

Because resurfacing of streets constitutes an alteration under the ADA, it triggers the obligation to provide curb ramps where pedestrian walkways intersect the resurfaced streets. See *Kinney v. Yerusalem*, 9 F 3d 1067 (3rd Cir. 1993). This obligation has been discussed in a variety of technical assistance materials published by the Department of Justice beginning in 1994.<sup>2</sup> Over the past few years, state and local governments have sought further guidance on the scope of the alterations requirement with respect to the provision of curb ramps when streets, roads or highways are being resurfaced. These questions have arisen largely due to the development of a variety of road surface treatments other than traditional road resurfacing, which generally involved the addition of a new layer of asphalt. Public entities have asked the Department of Transportation and the Department of Justice to clarify whether particular road surface treatments fall within the ADA definition of alterations, or whether they should be considered maintenance that would not trigger the obligation to provide curb ramps. This Joint Technical Assistance addresses some of those questions.

#### Where must curb ramps be provided?

Generally, curb ramps are needed wherever a sidewalk or other pedestrian walkway crosses a curb. Curb ramps must be located to ensure a person with a mobility disability can travel from a sidewalk on one side of the street, over or through any curbs or traffic islands, to the sidewalk on the other side of the street. However, the ADA does not require installation of ramps or curb ramps in the absence of a pedestrian walkway with a prepared surface for pedestrian use. Nor are curb ramps required in the absence of a curb, elevation, or other barrier between the street and the walkway.

# ADA Scoping

## Project Type

- **Title II** – The City of Columbus and other Title II agencies are held to a higher standard, and certain operations trigger ADA compliance beyond what the project immediately disturbs.
- Private entities working within the ROW are required to repair the area directly disturbed up to current ADA compliance.

# ADA Scoping

## Project Type

- **CIP Roadway projects** will make curb ramps for all legs of an intersection compliant when compliance is triggered at one leg. 3P projects are considered CIP projects
- **CIP Utility projects** will generally be triggered into ADA compliance by the resurfacing required. Where only one leg of an intersection is affected, only that leg is required to be made compliant for CIP utility projects



# Project Response Priorities

## Project Type

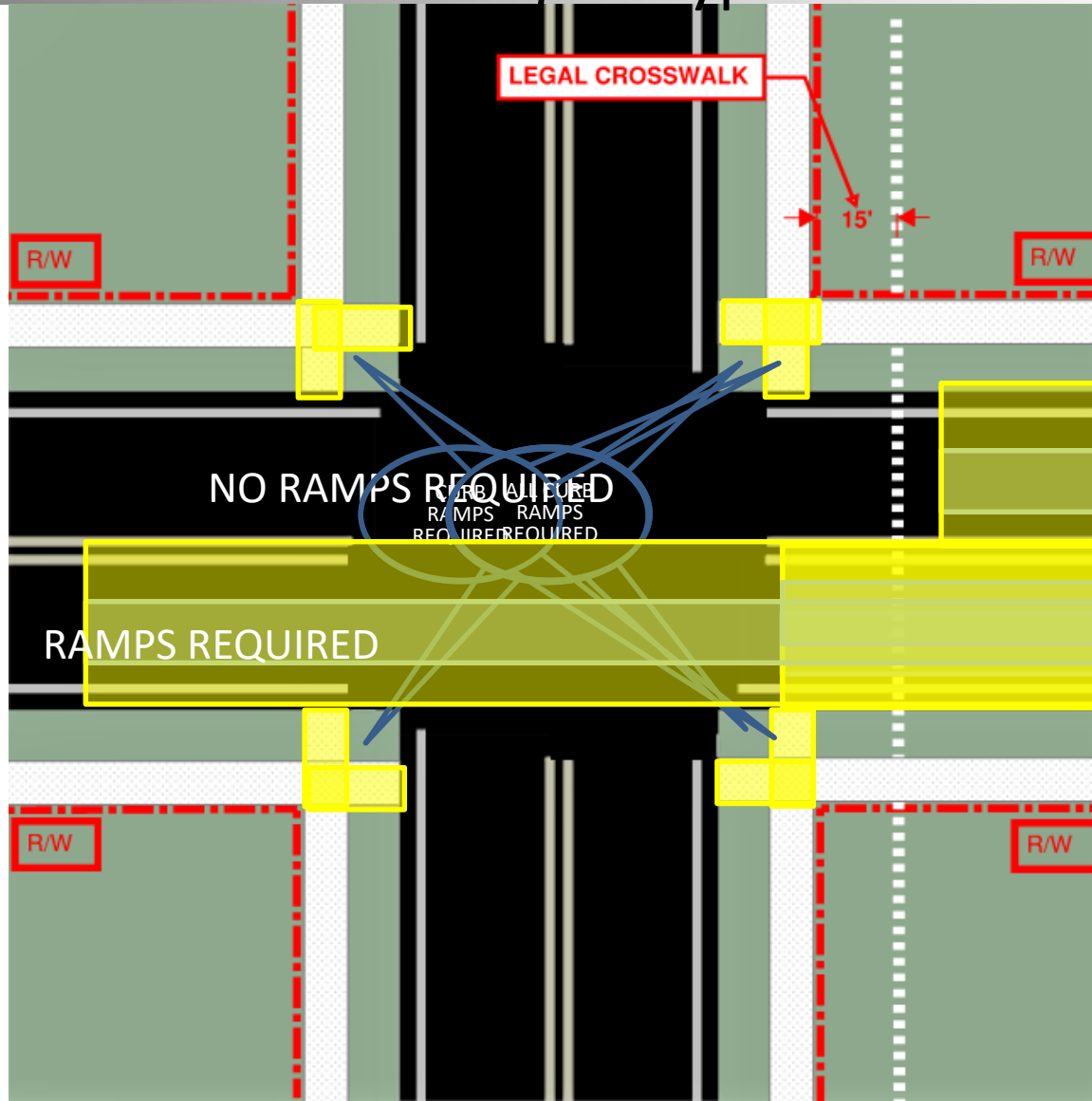

# ADA Scoping

## Project Type

- **Privately funded roadway improvements** typically bring the legs of the PAR that they impact into compliance.
- This could be CC plan, E-plan, or Permit work
- When ramps at one corner are replaced, there must be ramps on the opposite side of the street to receive them, unless there is no sidewalk or pushbutton.
- The entire intersection will be designed, but the ramps will not to be constructed, only designed to a Design/Build level

# ADA Scoping

## Project Type

- Other ADA improvements trigger other ADA project requirements.
- Such as signal work will trigger current pushbutton compliance.
- Pavement reconstruction would require the roadway to have a compliant PAR at the crosswalk.
- Projects without utility relocation may not be required to move poles to achieve a 4' PAR



# ADA Scoping

## Project Type

- **Homeowner improvements** – When a single unit dwelling on an existing platted lot replaces sidewalk in front of the property, they will not be required to construct the ramp.
- The DPS permit section will report these locations to the DOIM (Department of Infrastructure Management) designee for construction using the annual Citywide Curb Ramp Project

# ADA Scoping

## Project Type

- **Private Utility**

- Any corner disturbed will be required to be brought into current compliance. If there is no existing ramp, one must be constructed
- Resurfacing only will not require ramp construction if the sidewalk was not disturbed
- A design/build level drawing must be submitted to construction inspection for approval by the City, and Compliance sheet completed and submitted after it's constructed

# ADA Scoping

## Private Utility (Before)



# During



# After





# ADA Scoping

## Existing Ramps

- After determining the area required to be brought into ADA compliance, it is important to determine which existing ramps are already compliant
- An existing curb ramp may be considered compliant if it contains a currently accepted detectable warning in good condition and has no visible signs of non-compliance. Currently accepted detectable warnings do not include brick.
- If it does not appear “**visually compliant**”, the designer must complete a compliance form.

# ADA Scoping

## Existing Ramps

- Items that can be verified visually

- Ramp uses flares appropriately (long/short)
- No lips at joints, cracks or the roadway interface greater than ¼”
- Ramp appears to have a landing/turning space
- Ramp grade does not appear excessive

- You won't be able to eyeball an 8.5% grade vs an 8.3% grade

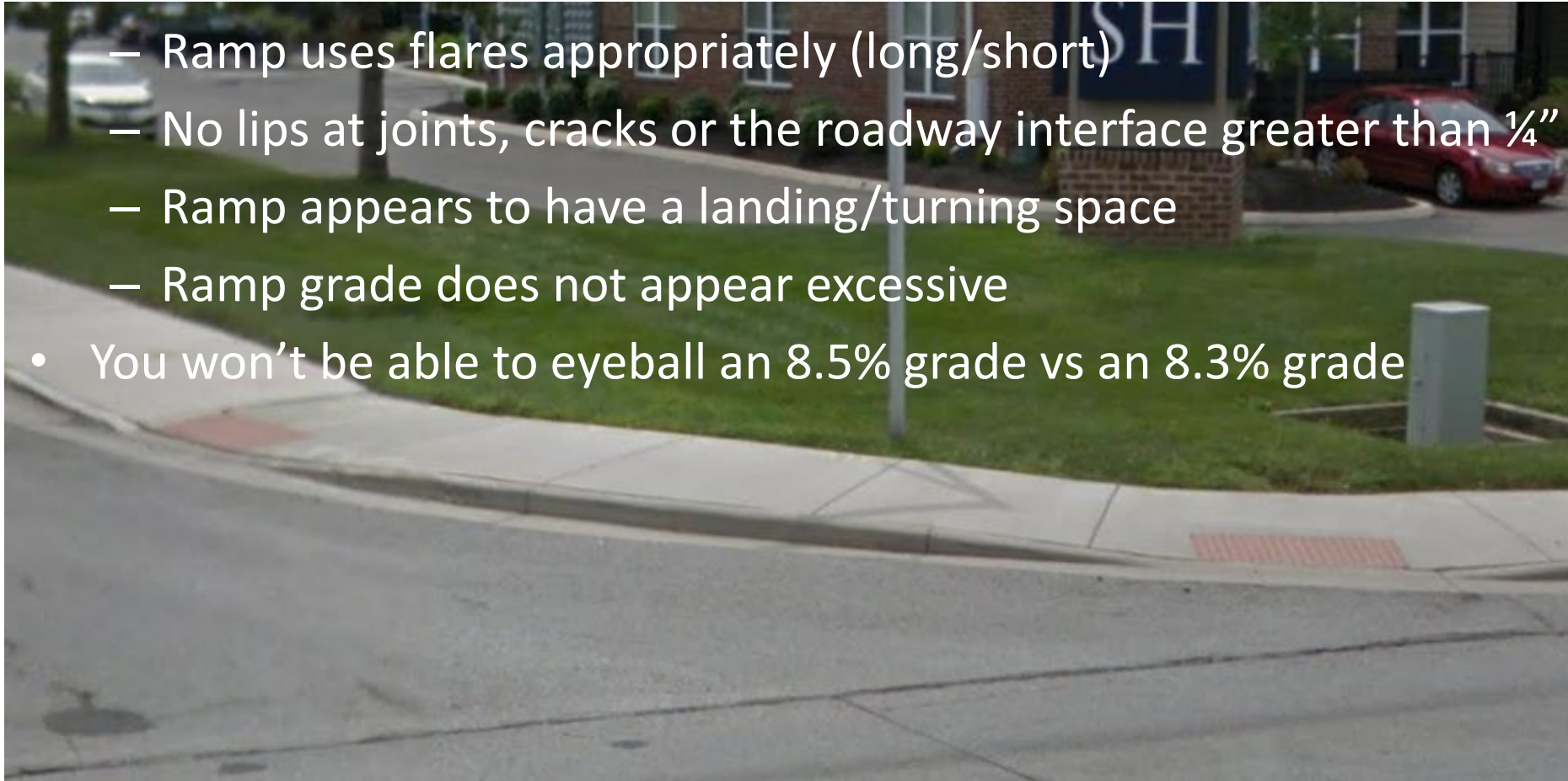

# ADA Scoping

## Existing Ramps

Serious drainage problems MAY be cause for replacement. Sediment and debris built up can be evidence of an issue. Minor sediment is normal.

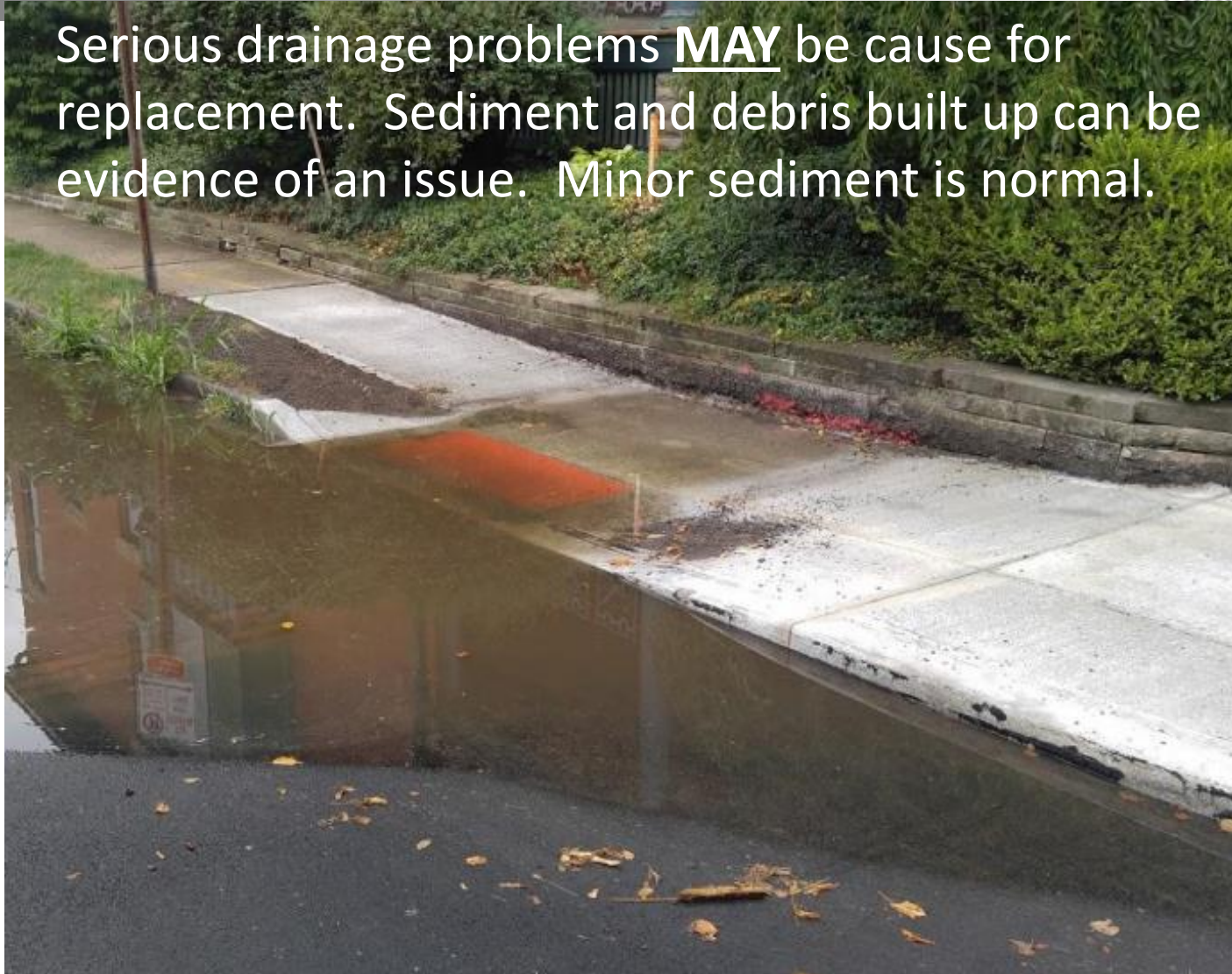

# ADA Scoping Existing Ramps

## Visually Non-Compliant Ramps



Vertical drop  
>1/2" in PAR at lip

# ADA Scoping Existing Ramps

## Visually Non-Compliant Ramps

Options to comply:

- Extend the DWS
- Move the curb transition to remove the flush area not covered by the DWS.

A photograph of a sidewalk ramp leading to a street. The ramp is made of concrete and has a red textured surface at the top. A yellow curb is visible at the edge of the ramp. A white line on the asphalt road indicates a curb transition. Red lines are drawn on the image to highlight the curb transition area. A white callout box with a black border points to this area.

Curb Transition

# ADA Scoping Existing Ramps

This ramp is not compliant because the casting is in the DWS.

Options to comply:

- Casting should be relocated
- Curb ramp should be shifted to avoid the casting.



Visually Non-Compliant Ramps



# ADA Scoping

## Existing Ramps

- Some existing ramps are fully compliant except they are missing a detectable warning.
- In these cases, complete a compliance form documenting the ramp is otherwise compliant and add a Type D Detectable Warning (Stick-on)



Equal Access  
Solved?....

We might  
need some  
technical  
requirements





# ADA Design Basics

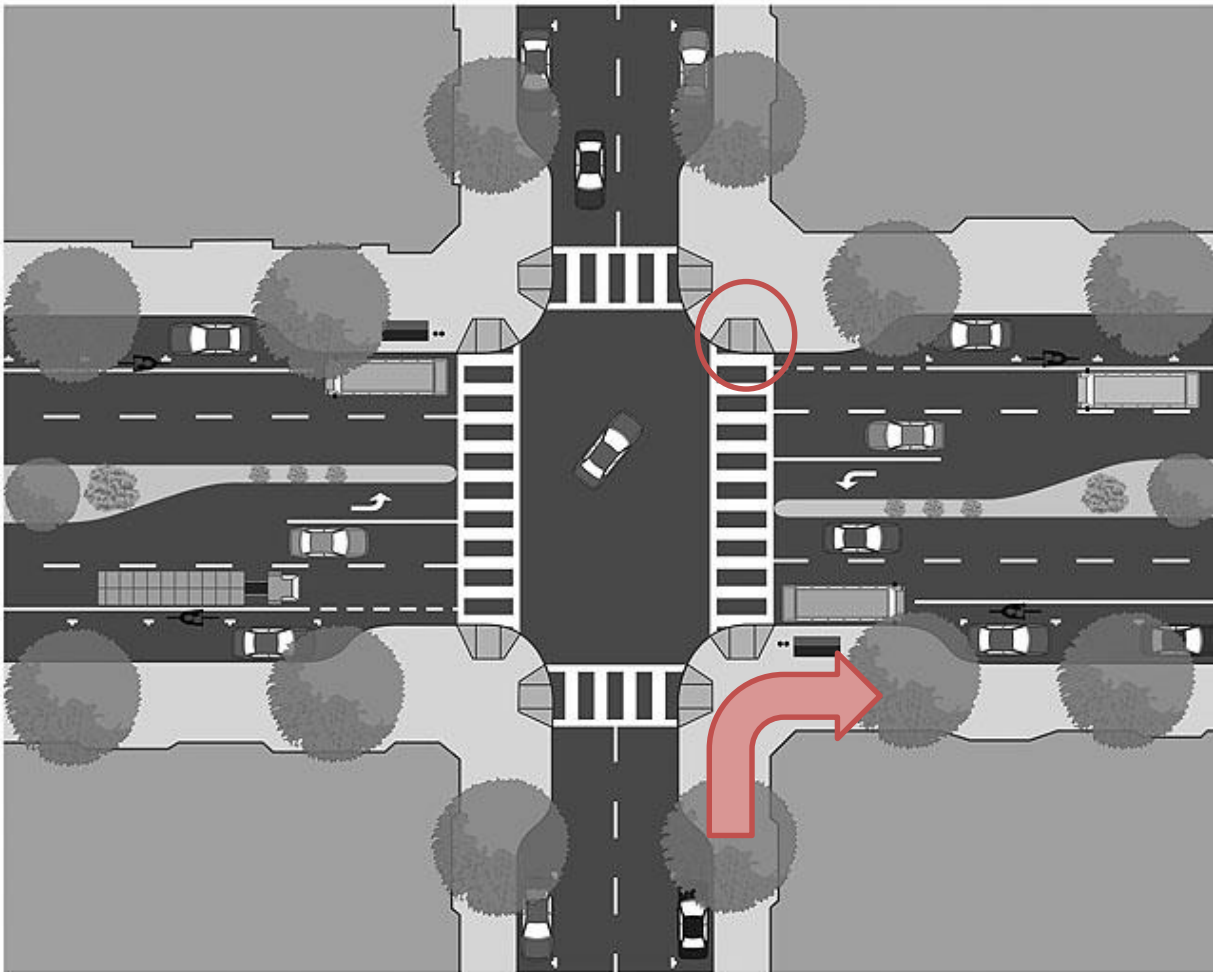

- **PAR-Pedestrian Access Route**
- **Curb Ramps and other components**

# ADA Design Basics

## PAR

### PAR=Pedestrian Access Route

- It is a path *through* and *contained within* a pedestrian facility, and has slope, grade, surface characteristics, and other features that make it useable by persons with mobility, sensory, or cognitive impairment conditions.
- It is an *unbroken, unobstructed* route that provides access to any destination along a given right-of-way, that can otherwise be reached by an able-bodied pedestrian.
- Stairways and escalators are not considered part of a **PAR**.

# ADA Design Basics

## PAR

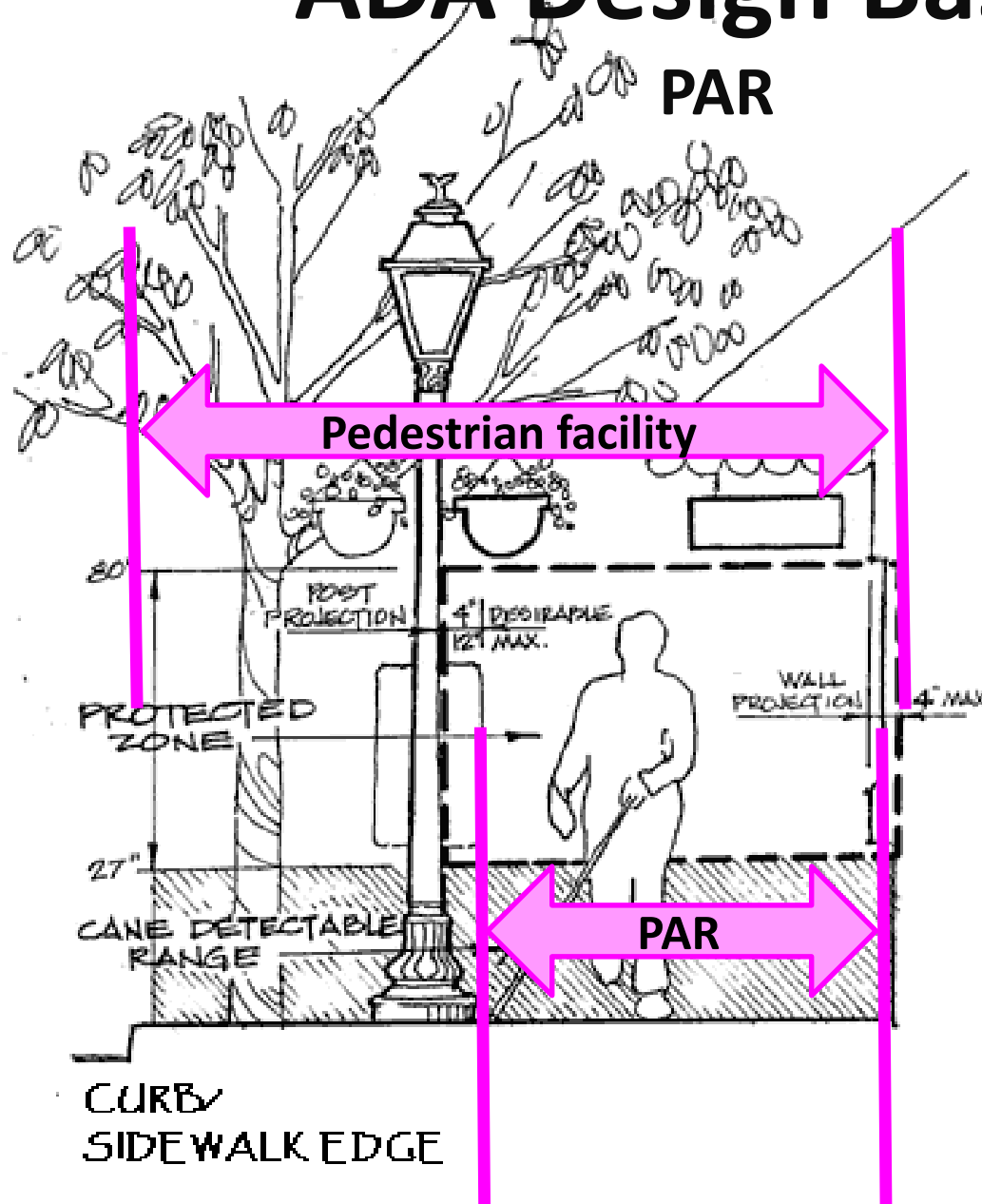

### PAR is to be:

- no less than 4ft wide
- may not be reduced in width due to street furnishings (e.g., bicycle racks, parking meters, newspaper stands....)
- may extend the entire width of a sidewalk or walkway, or it may consist of only a specified width of the overall path.

# ADA Design Basics

## Protruding Objects

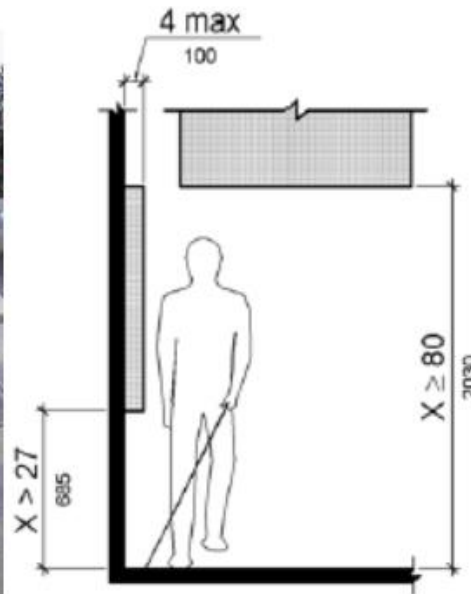

- ❑ Objects between 27" and 80" may not protrude more than 4".
- ❑ Entire pedestrian circulation route!

# ADA Design Basics

## Protruding Objects



# ADA Design Basics

## Protruding Objects

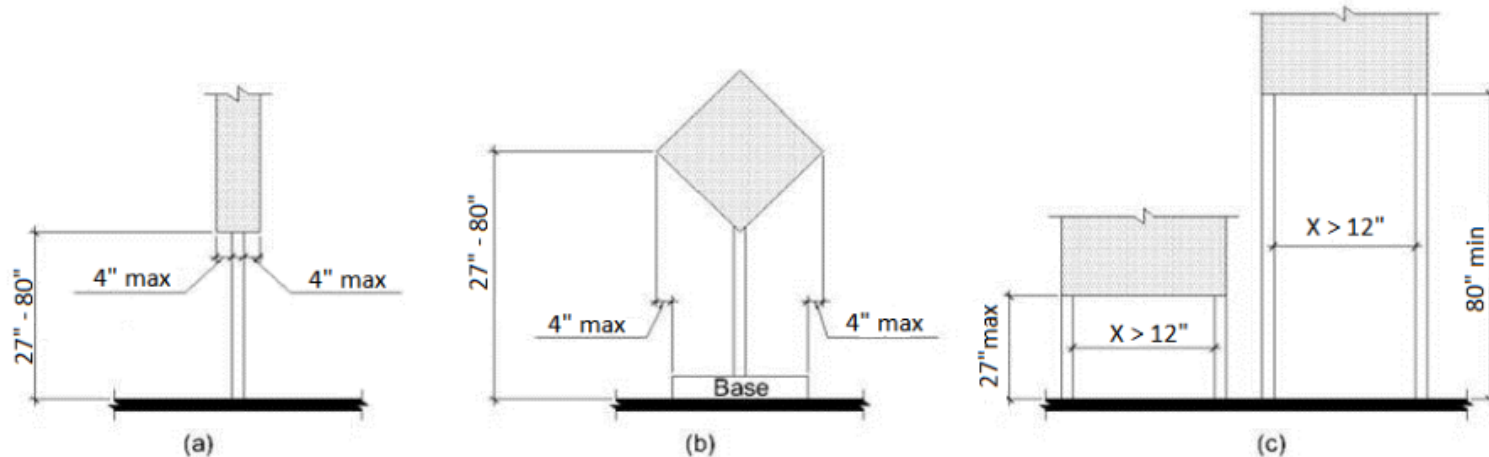

- Post mounted objects must not protrude more than 4" beyond the base
- Space greater than 12" between posts must be detectable

# ADA Design Basics

## PAR



# ADA Design Basics

## PAR is to be:

- Where the clear width of pedestrian access routes is less than 5.0 feet, passing spaces shall be provided at intervals of 200.0 feet maximum. Passing spaces shall be 5.0 feet minimum by 5.0 feet minimum. Passing spaces are permitted to overlap pedestrian access routes.

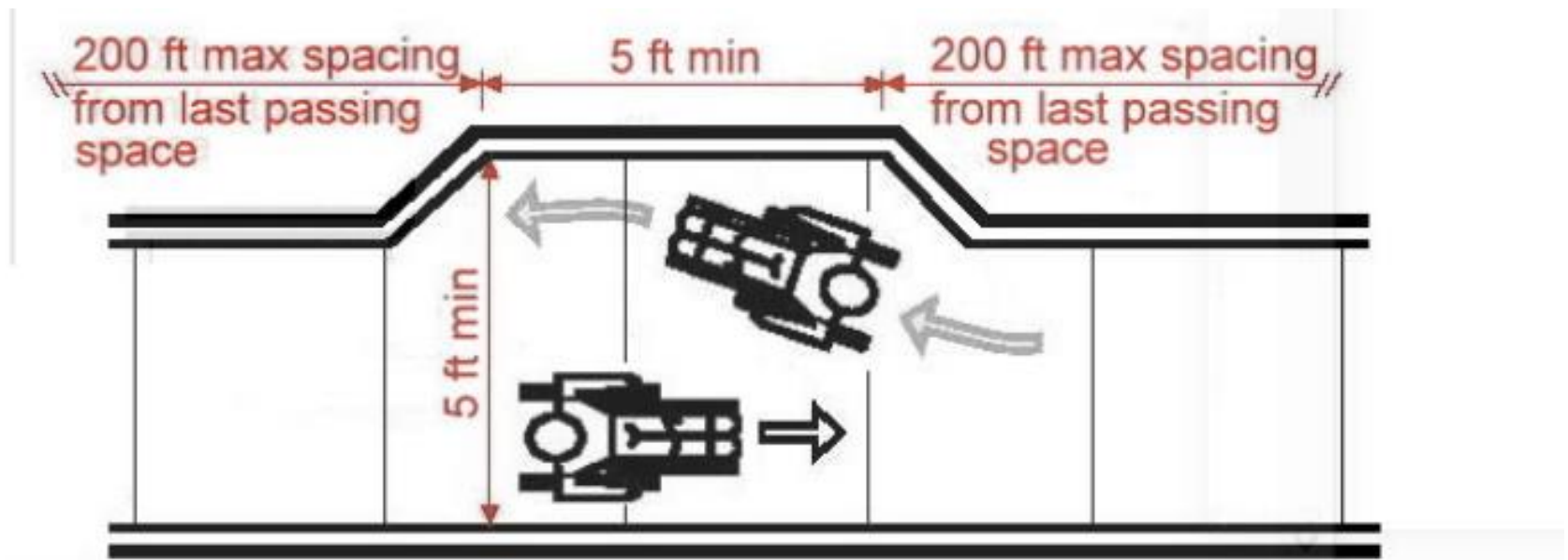



# ADA Design Basics

**Curb Ramps** have the primary function of providing access from the sidewalk to the street when curb is present.

- Typically installed at legal crosswalks (intersections)
- May provide access to pedestrian facilities (pedestrian activated push buttons)
- Are **NOT** installed where **NO** sidewalk (or pedestrian facility) is present

# ADA Design Basics

## Curb Ramps

### A Compliant Curb Ramp has the following Components:

- Landings-turning space
- Flares
- Slope
- Running Slope
- Cross Slope
- Counter Slope
- Detectable Warning

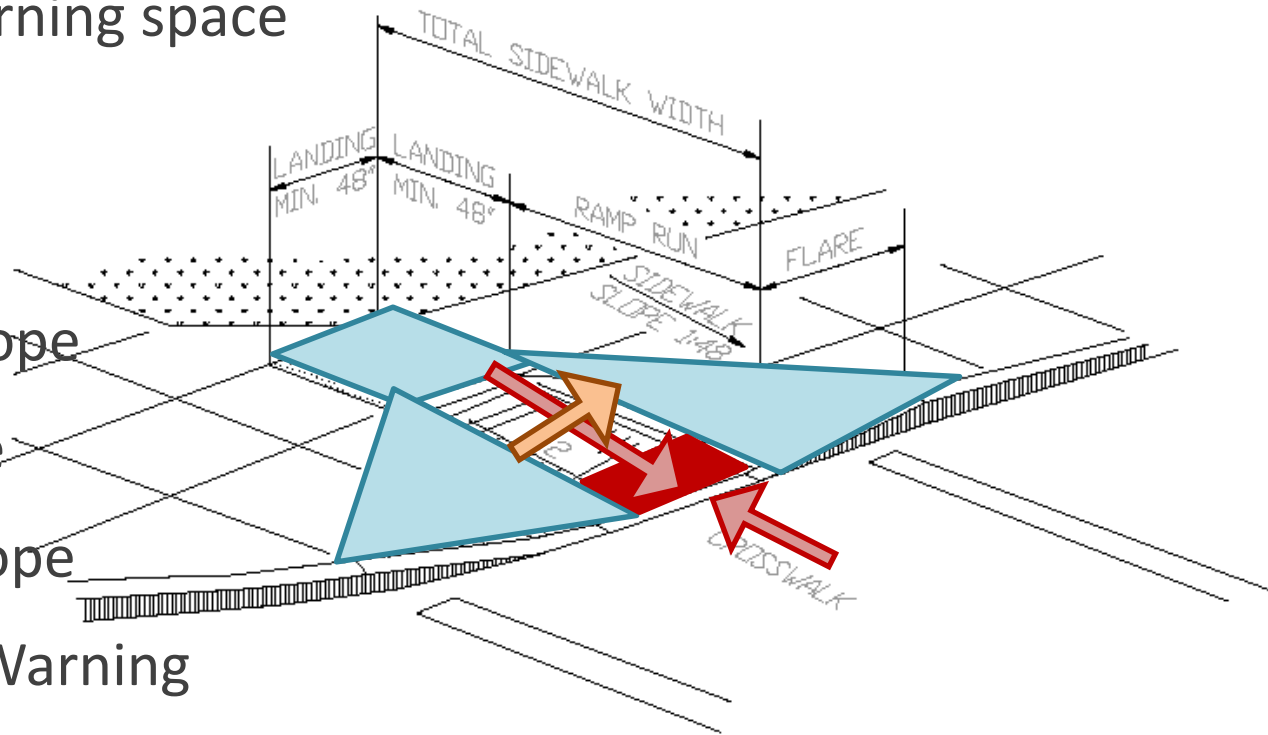



# ADA Design Basics

## Landings

Figure R304.2.1 Turning Space

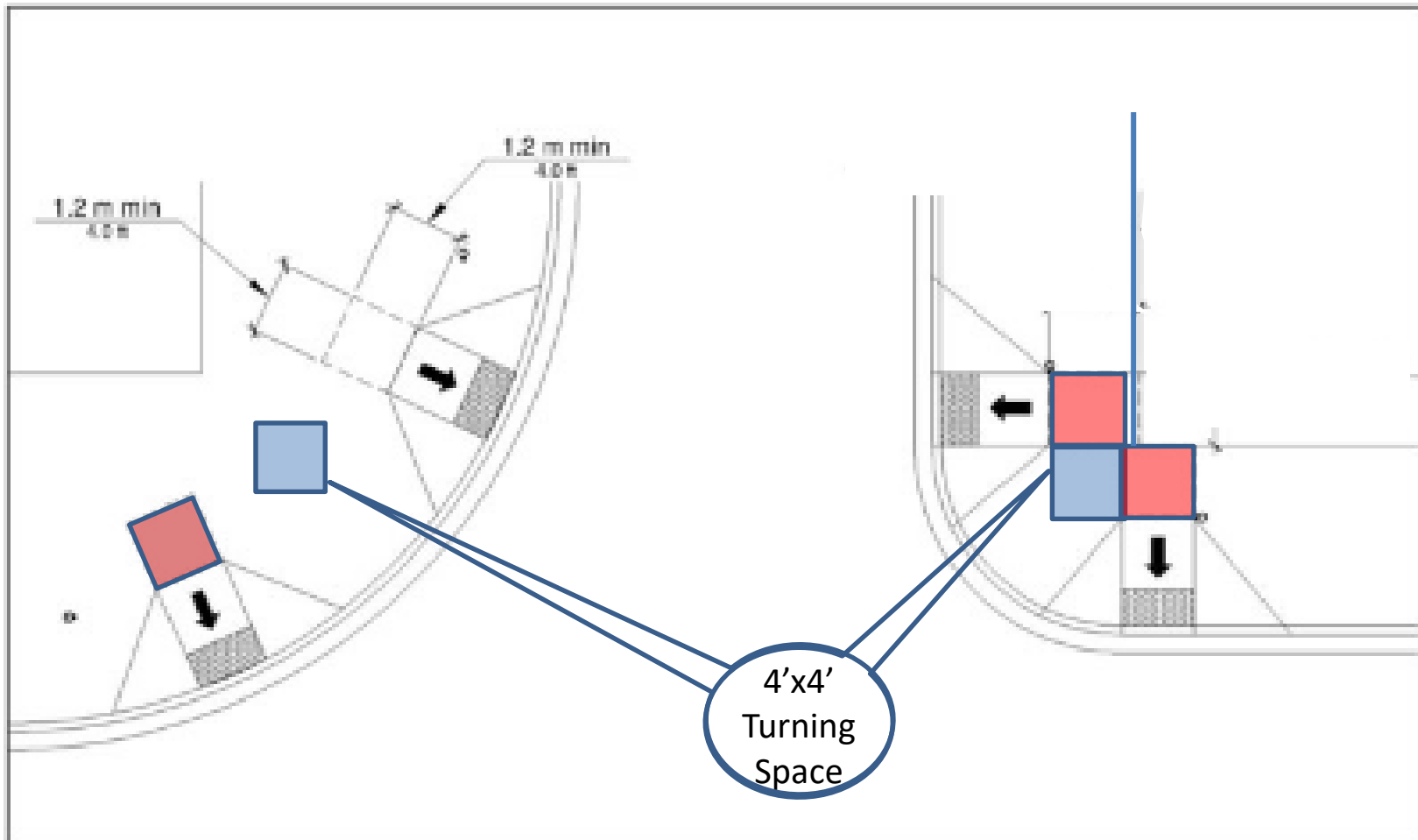

# ADA Design Basics

## Flares

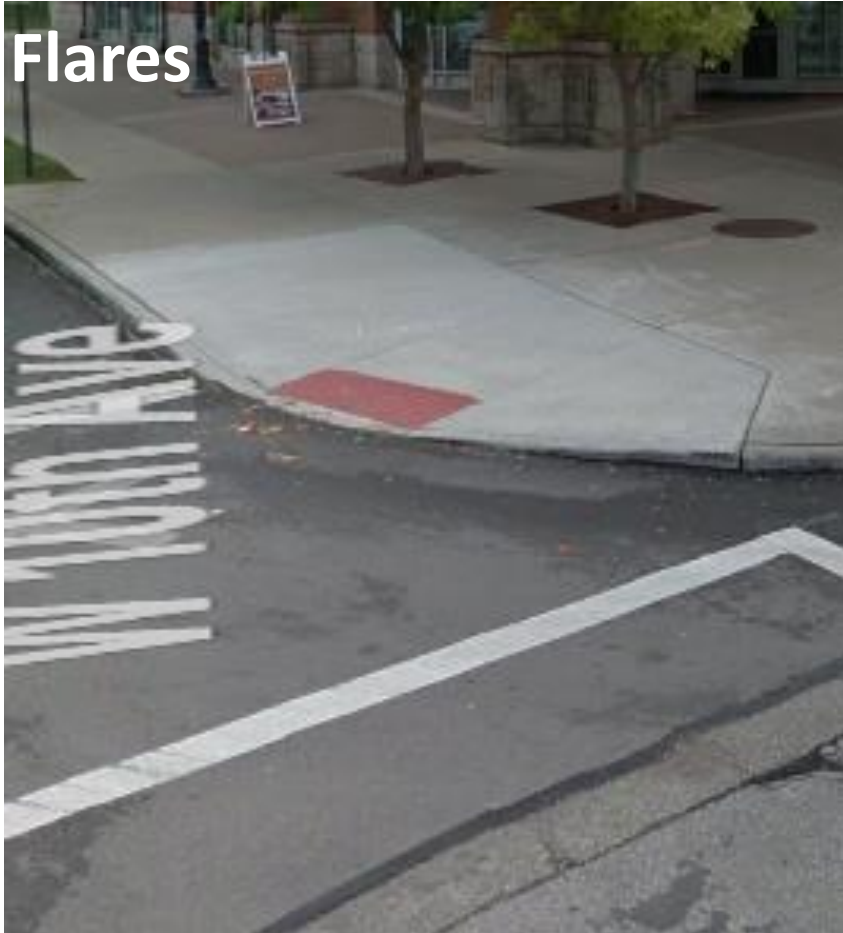

### REQUIREMENT:

#### Long Flares

- Required on perpendicular ramps
- No steeper than 10% (i.e., 6" curb requires a 5' flare), measured along the curb line
- Required where the circulation path or walkable surfaces is adjacent to the curb ramp.
- **Advisory R304.2.3 Flared Sides.** The flared sides are part of the pedestrian circulation path, but are **not** part of the pedestrian access route. Curb ramps whose sides have returned curbs provide useful directional cues where they are aligned with the pedestrian street crossing and are protected from cross travel by landscaping, street furniture, chains, fencing, or railings.

# ADA Design Basics

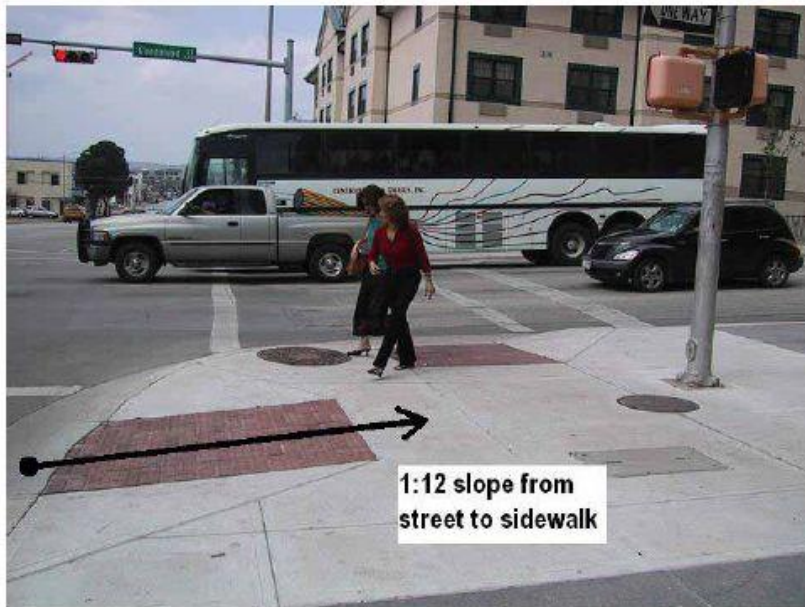
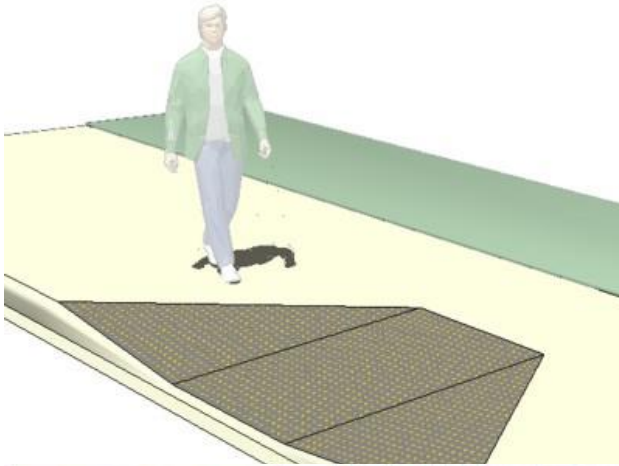

**Long Flares are walkable**

# ADA Design Basics

## Flares

**REQUIREMENT:** Flares

### Short Flares

Can be used where there is a non-walkable surface (grass, trees, landscaping, areas blocked by utility pole, street furnishings, hydrants, etc.) adjacent to the ramp,

i.e., should never be used at any location where pedestrian traffic can be expected to cross the curb ramp

Are commonly 6" to 12" wide at the curb

Note: Manhole covers and hatches are considered to be walkable surfaces, if they are flush with the sidewalk surface.



**RAMP TYPE D**

# Improper Flare use



Its either DW or Flare where sidewalk is flush to the street



# Improper Flare use



We have had to replace otherwise compliant ramps due to poor flare installation

# Improper Flare use



Concrete is flush at street

# ADA Design Basics

## Running slopes

There are ramp requirements which are the **Federal Standard, established by the Department of Justice** and **City of Columbus Standards**.

- **City of Columbus Standard**
- Running slope maximum: 1:13, or 7.69%
  
- **Federal Standards**
- Running slope maximum: 1:12, or 8.33%
  
- **Inspection Guidelines**
- If an ensuing inspection notes this standard has not been met, yet the slope of the ramp does not exceed the Federal standard of 1:12, the ramp may be approved if it does not violate the other standards established by the City of Columbus.
- **There is no construction tolerance**, the difference between City and Federal requirements is the only construction tolerance available. **Anything outside of Federal standards is a FAIL.**

# ADA Design Basics

## Running slopes



# ADA Design Basics

## Cross slopes

- **REQUIREMENT:** Ramp and PAR Cross Slope
  - City of Columbus Standard
    - Cross slope maximum: 1:64, or 3/16" per foot, or 1.56%
  - Federal Standards
    - Cross slope maximum: 1:48, or 1/4" per foot, or 2.08%
  - Inspection Guidelines
    - Ramps are to be designed and constructed to the 1:64 cross slope maximum.
    - If an ensuing inspection notes this standard has not been met, yet the slope of the ramp does not exceed the Federal standard of 1:48, the ramp may be approved if it does not violate the other standards established by the City of Columbus.
    - \*\*Blended Transitions are required to also meet this standard for cross slope.

# ADA Design Basics

## Cross slopes



Source: PROWAG-Proposed Right of Way Accessibility Guidelines

# ADA Design Basics

## Cross slopes



Source: PROWAG-Proposed Right of Way Accessibility Guidelines

# ADA Design Basics

## Alley PAR

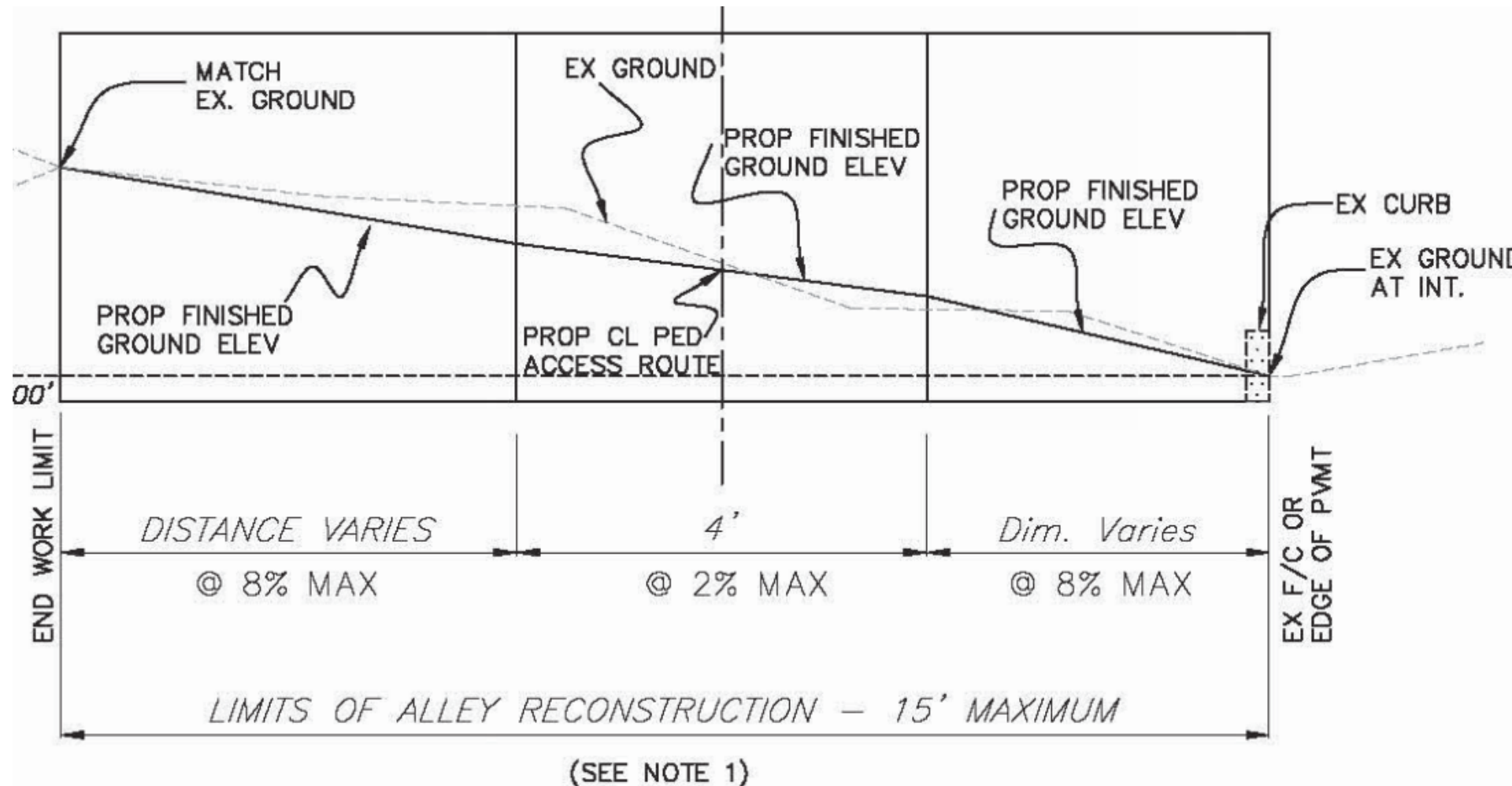



# ADA Design Basics

## Counter slopes

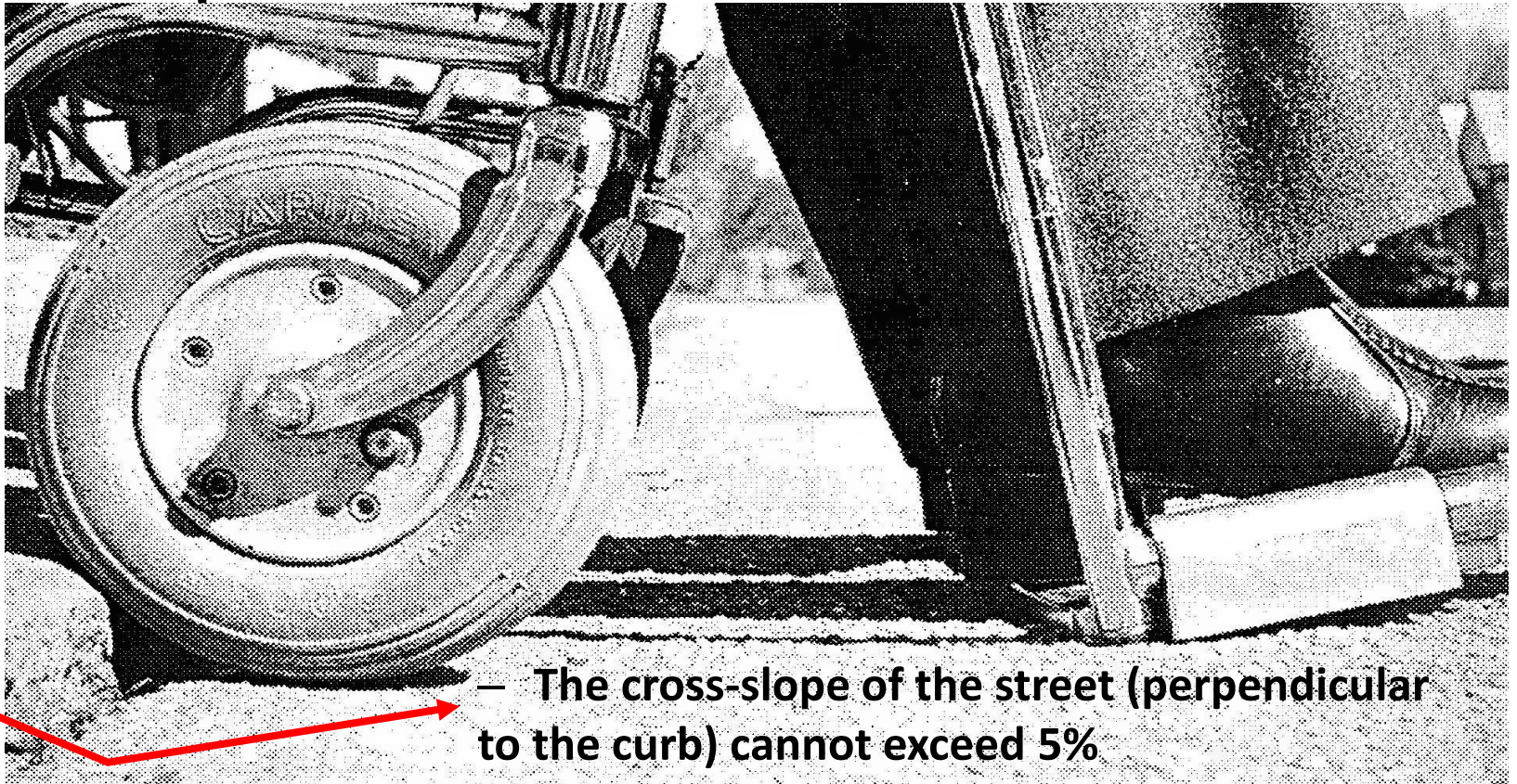

Bottoming out at opposing slopes

# ADA Design Basics

## REQUIREMENT: Off-Sets

- A vertical change in level (lip) greater than  $\frac{1}{4}$ " is not permitted on curb ramps, blended transitions, landings, and gutter areas within the **PAR**.



# ADA Design Basics

## Clear Space

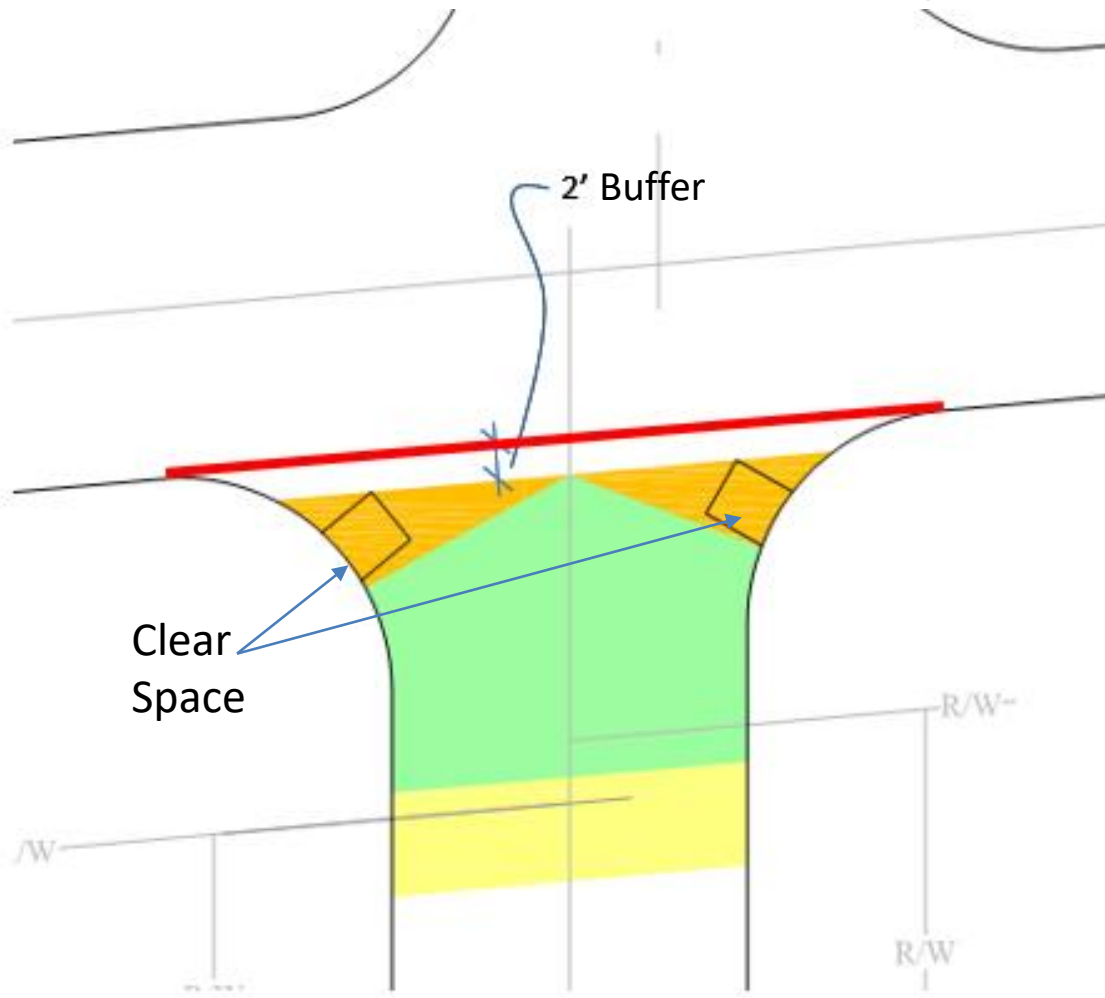

### Curb Ramp Design Boundary

-Beyond the bottom grade break, a clear space (minimum 4'x 4') shall be provided within the width of the pedestrian street crossing and wholly outside the parallel vehicle travel lane with a 2' buffer.

-Purpose is for turning  
-not required to meet 1.56%

# ADA Design Basics

## Detectable Warnings

- A **Detectable Warning (DW)** is used to provide a distinct surface of truncated domes, detectable by cane or underfoot, and is of a contrasting color, to alert those with vision impairments of the transition to a vehicular route.
  - *Note: all DW must be installed so that the unit is surrounded by a border of concrete.*
  - **Truncated Domes**
    - Shall comply with City of Columbus **Standard Drawings 2319**,
  - *Note: all DW installed in Columbus **MUST** be from the list of products approved by the City of Columbus, available at our website).*
    - These include cast in place and stick on, as well as cast iron or granite that can be used downtown. Brick is no longer an approved material.

# ADA Design Basics

## Detectable Warnings

*Note: The truncated domes must be aligned parallel & perpendicular to the curb line*

Included in all PAR crossings of

- Public roadways
- Alley crossings
- Striped commercial drives

Identify following features:

- Curb ramps
- Blended transitions
- Borders of medians/islands
- Street crossings for shared use paths
- Sidewalk crossing at RR tracks

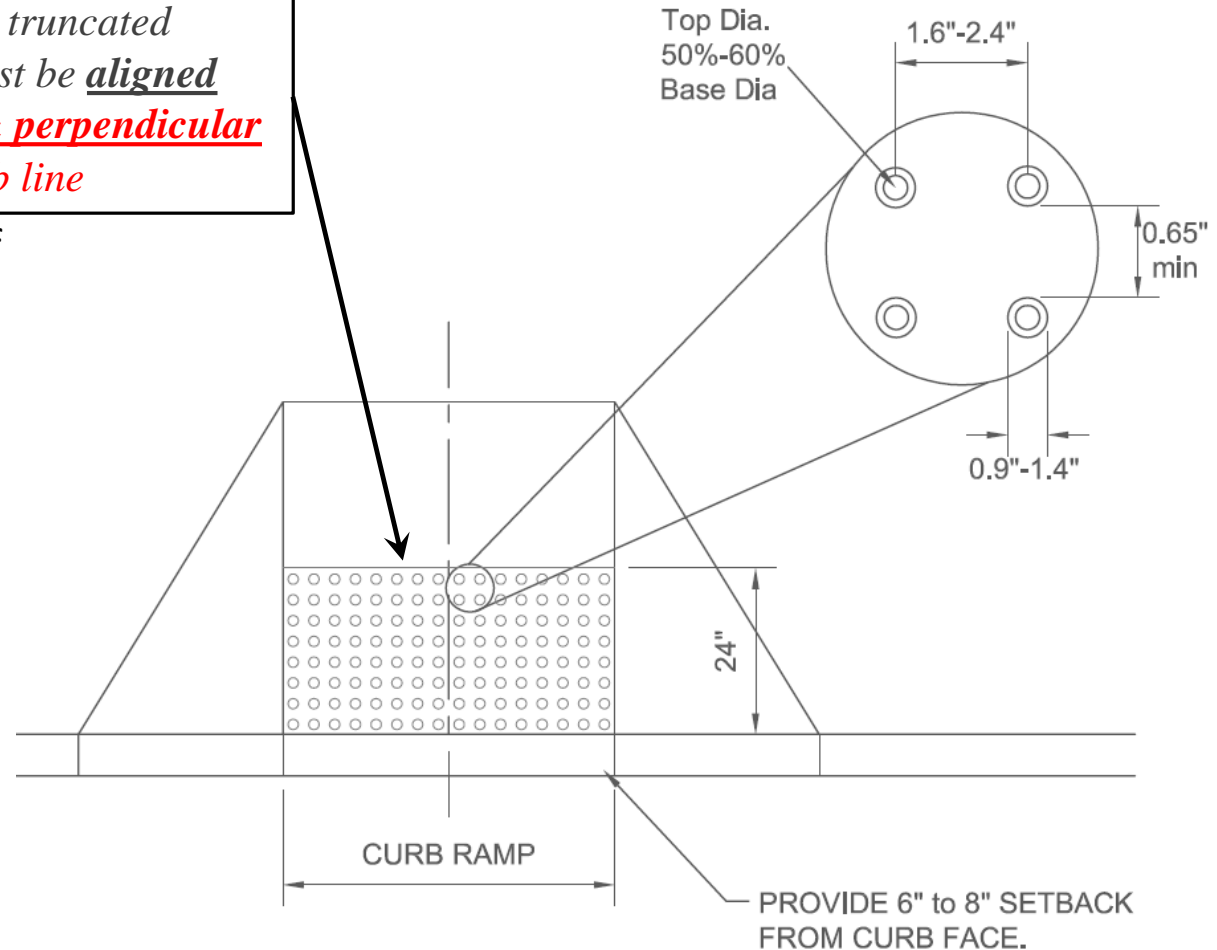

# ADA Design Basics

## Detectable Warnings

Place DW on curb ramp at grade break if Clear Space at bottom of ramp is less than 5' deep.

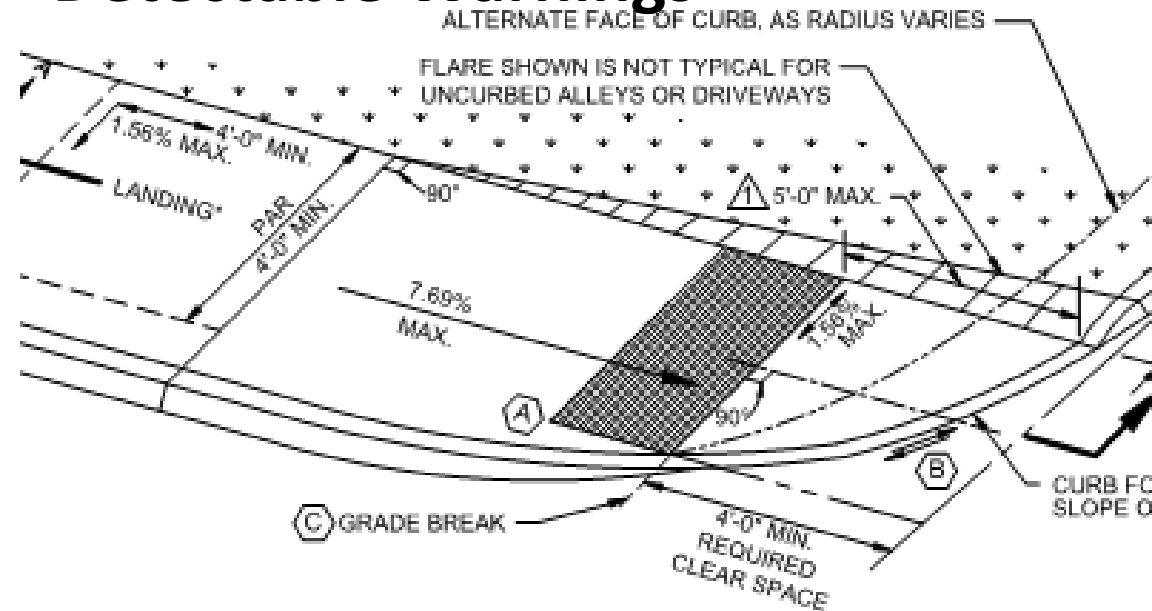

Place DW on clear space if clear space is more than 5' deep at any point (DW moves but grade break does not).

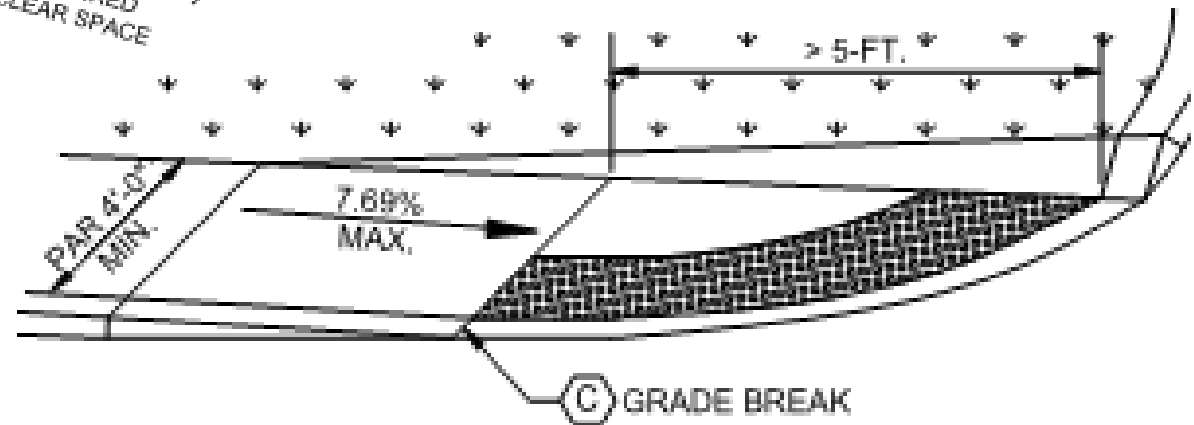

# ADA Design Basics

## Blended Transition

Elements of a PAR that serve the same function as a curb ramp and all requirements of the curb ramp remain with the exception of a landing is not required and the running slope cannot exceed 5%.

We recently added a blended transition drawing to SCD 2319



# ADA Design Basics

## Blended Transitions

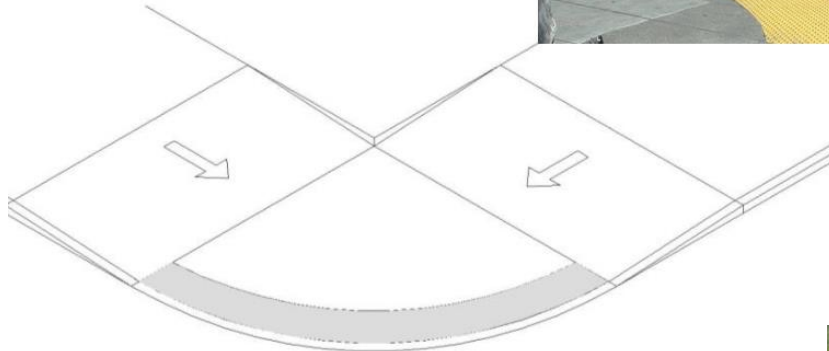

Blended Transition (depressed corner)



Blended transition at a raised PAR



# ADA Design Basics

## Pinch Points

- An allowance is made for a narrower than 4' PAR for a very short distance on **Alteration Projects Only**.
- The obstruction creating the pinch point must be out of the scope of the project and considered technically infeasible
- Pinch Point requirements are based on 2010 DOJ Standards

# ADA Design Basics

## Future Policy Update: Narrow sidewalk

When at least 3' of sidewalk is not available, the sidewalk will not be considered a PAR.



# Narrow Sidewalk Examples



# Narrow Sidewalk Examples



# ADA Design Basics

## Gratings and Access Covers

- Gratings, access covers, and other appurtenances shall not be located on curb ramp landings or slopes
- These items can show up in the PAR if they are flush and compliant per DOJ 2010 Standards

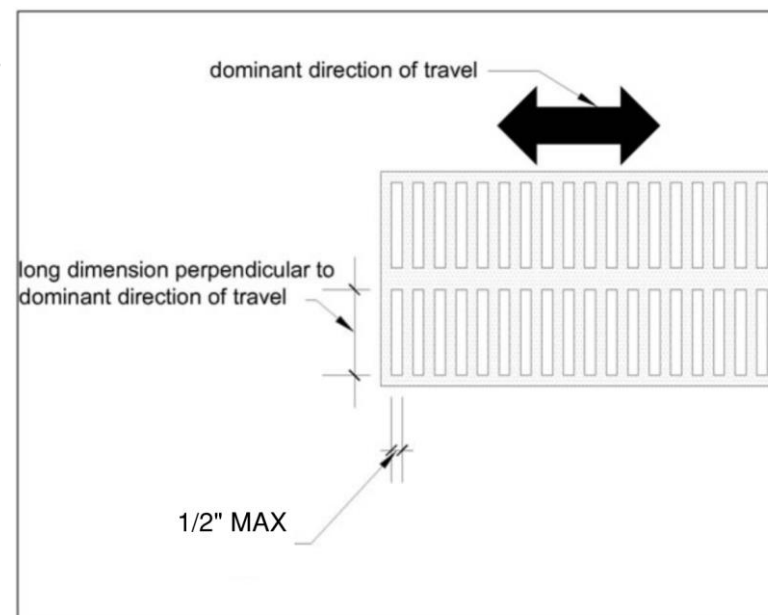

Grate orientation must be so that the wide opening is perpendicular to the pedestrian

# ADA Design Basics

## Gratings and Access Covers

We do not want tree grates to be part of the required PAR



# ADA Design Basics

## Basement vaults

- Another existing condition to identify and address when designing ADA are basement vaults
- Basement vaults should be identified in design wherever possible. Look for clues on the surface.
- Basement vaults are most common downtown, but appear in other older areas of town also.
- Columbus provides direction on filling or keeping vaults in the “Basement Vault in the Right of Way Policy and Procedures” located:  
<https://www.columbus.gov/publicservice/Design-and-Construction/Document-Library/>

# ADA Design Basics

## Basement vaults





# ADA Design Basics

## Basement vaults



Metal angle on the curb is often an indicator of a vault below

# Ramp Design Guidance

## Ramp type hierarchy

### **CITY OF COLUMBUS RAMP TYPE HIERARCHY**

**TIER 1** (THESE PERPENDICULAR RAMPS SHOULD BE USED WHENEVER POSSIBLE.)

- TYPE A
- TYPE C
- TYPE D

**TIER 2** (PARALLEL RAMPS SHOULD ONLY BE USED DUE TO RIGHT OF WAY (ROW) OR OTHER SPACE CONSTRAINTS WHERE A TIER 1 RAMP CANNOT BE USED.)

- TYPE P-6
- TYPE P-7
- TYPE P-5
- TYPE P-4

**TIER 3** (TIER 3 RAMPS CAN ONLY BE USED WITH WRITTEN APPROVAL BY THE CITY ENGINEER OR DESIGNEE. TIER 3 RAMPS SHALL BE IDENTIFIED IN THE DESIGN SCOPE OR APPROVAL REQUESTED BY THE DESIGNER JUSTIFYING THAT THIS RAMP TYPE IS NECESSARY.)

- TYPE J (MODIFIED ALLEY RAMP), USE SHOULD BE LIMITED DUE TO DRAINAGE CONCERNS
- RADIAL RAMPS
- SINGLE SHARED RAMPS

**SPECIALTY RAMPS** (SHALL ONLY BE USED FOR THE LISTED SITUATION, OR WRITTEN APPROVAL BY THE CITY ENGINEER OR DESIGNEE.)

- TYPE G - ONLY TO BE USED ON ALLEY CROSSINGS
- TYPE H - ONLY TO BE USED ON ALLEY CROSSINGS
- TYPE L-1 - ONLY FOR MEDIAN CROSSINGS
- TYPE L-2 - ONLY FOR MEDIAN CROSSINGS
- PEDESTRIAN PADS - USED FOR ACCESS TO PUSHBUTTONS WHERE THERE IS NO EXISTING SIDEWALK. THE INTENT IS TO PROVIDE ACCESS TO CROSS THE INTERSECTION IN BOTH DIRECTIONS WITHOUT ENTERING THE STREET TO ACCESS TO OTHER CROSSING. THE FOLLOWING IS THE ORDER OF PREFERENCE ON PEDESTRIAN PADS:
  1. PP-1 TWO CONNECTED RAMPS WITH UTILITY STRIP
  2. PP-2 TWO CONNECTED RAMPS WITH SIDEWALK AGAINST CURB
  3. PP-3 USED AS SINGLE SHARED RAMP THAT CAN ACCESS BOTH CROSSWALK LEGS AND THE PUSHBUTTON
  4. PP-3 USED TO ONLY ACCESS THE LEG OF THE INTERSECTION CONTROLLED BY THE PUSHBUTTON

# Ramp Design Guidance

## Ramp Location

- The Curb Ramp Design Boundary drawing has been updated to provide an order of preference in locating curb ramps.
- Follow the Curb Ramp Design Boundary steps.
- Do not move to the next area of preference unless the more preferable area is exhausted.

# Ramp Design Guidance

- First area to place ramps
- Second area to place ramps
- Third area to place ramps

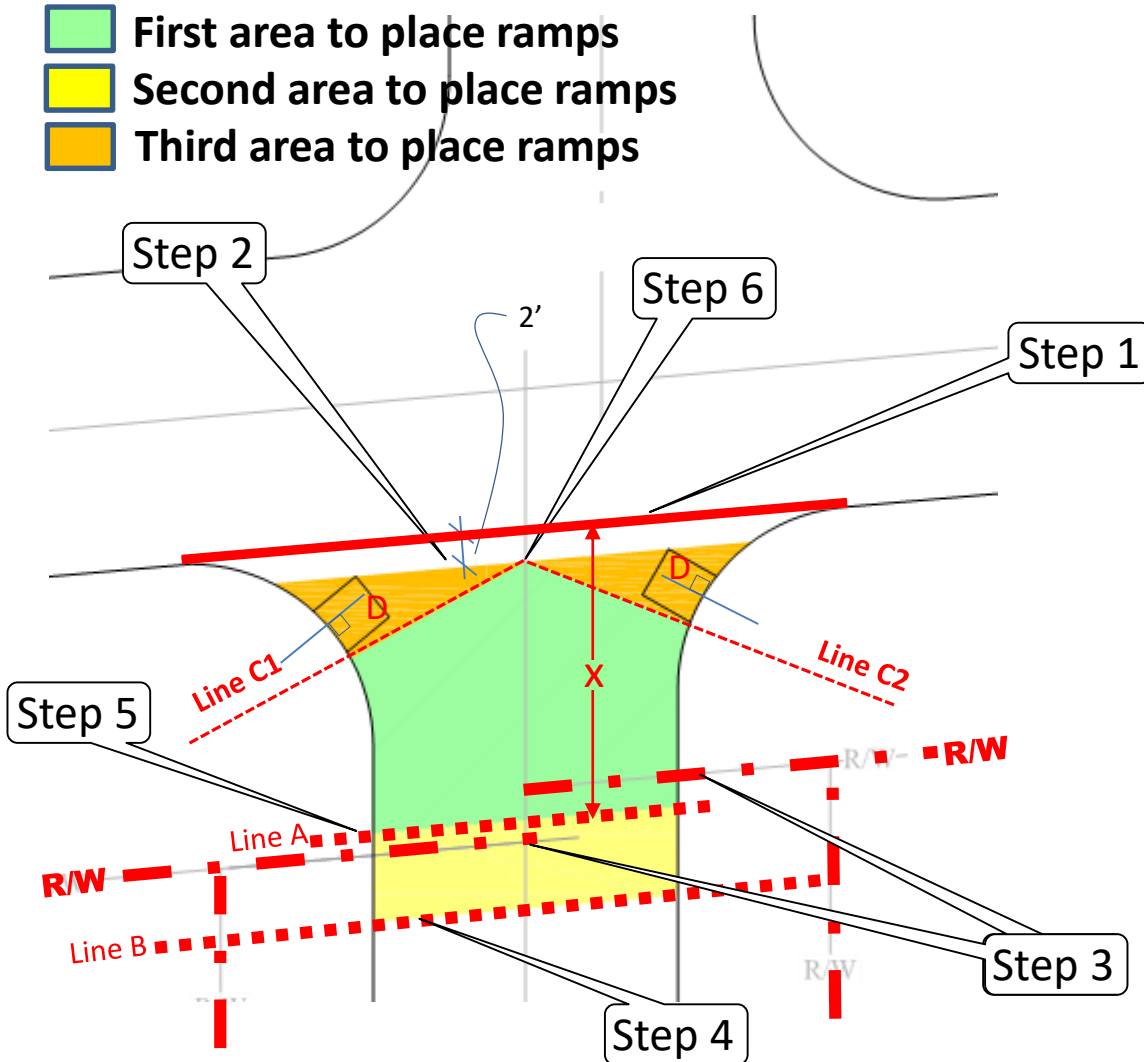

Step 1: Establish the curb line of the street. The curb line is the boundary between the street and the sidewalk. The curb line is shown as a solid red line in the diagram.

Step 2: Establish a 2-foot setback from the curb. This setback is shown as a dashed blue line in the diagram.

Step 3: Establish a line perpendicular to the curb. This line is shown as a dashed blue line in the diagram.

Step 4: Establish a line parallel to the curb. This line is shown as a dashed red line in the diagram.

Step 5: Establish a line parallel to the curb. This line is shown as a dashed red line in the diagram.

Step 6: Establish a line parallel to the curb. This line is shown as a dashed red line in the diagram.

The diagram also shows the Right-of-Way (R/W) and various lines (Line A, Line B, Line C1, Line C2) used in the design process. The ramp area is divided into three colored zones: green (first area), yellow (second area), and orange (third area).

and

# Ramp Design Guidance

## Ramp Type

- Existing conditions and particularly ROW space will limit the options of Ramp type
- Standard Drawing 2319 details the hierarchy in tiers
- Do not go to the next tier of ramps until the more preferred tier is exhausted
- Align ramp across from each other as much as possible, but there is no longer a 2' alignment rule

# Ramp Design Guidance

## Ramp Type

- **Tier 1** (perpendicular ramps)

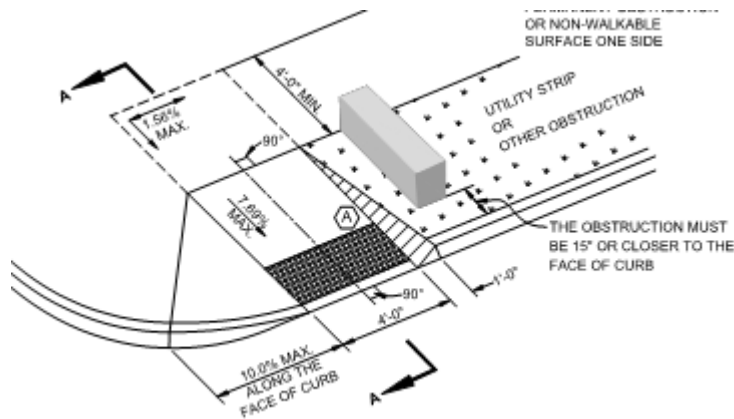

RAMP TYPE D

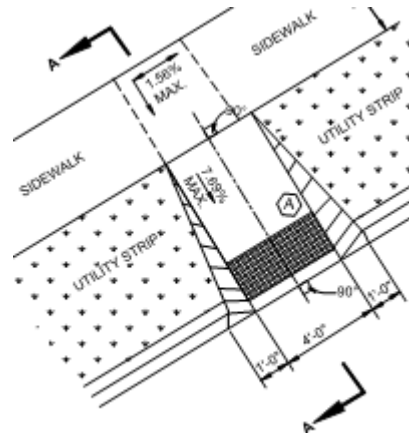

RAMP TYPE C

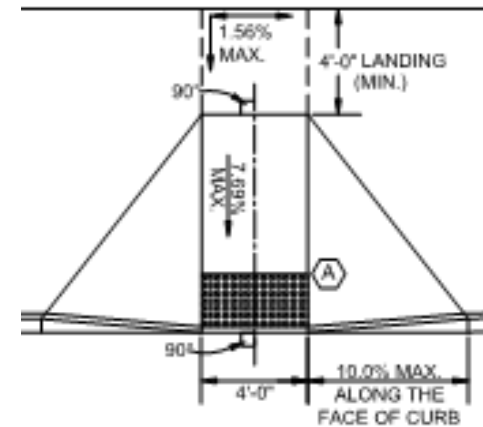

RAMP TYPE A

# Ramp Design Guidance

## Ramp Type

- TIER 2 (Parallel ramps)

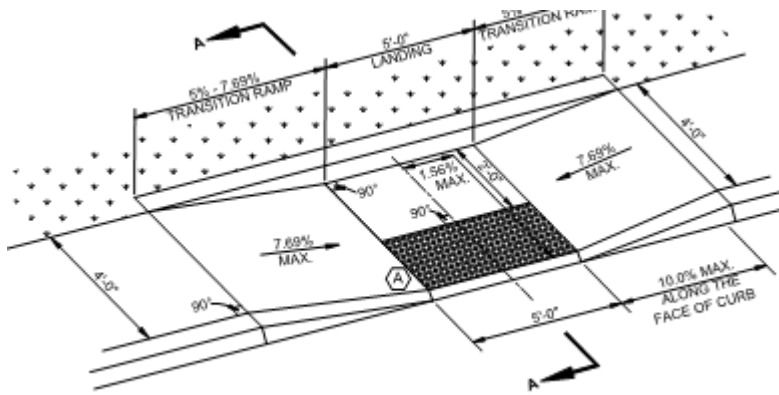

RAMP TYPE P-4

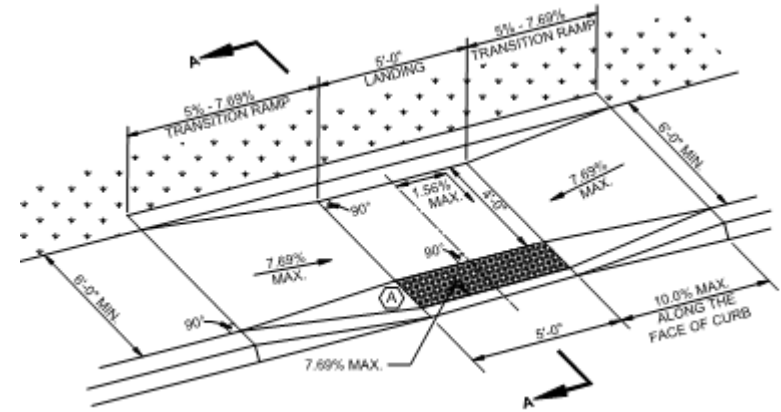

RAMP TYPE P-6

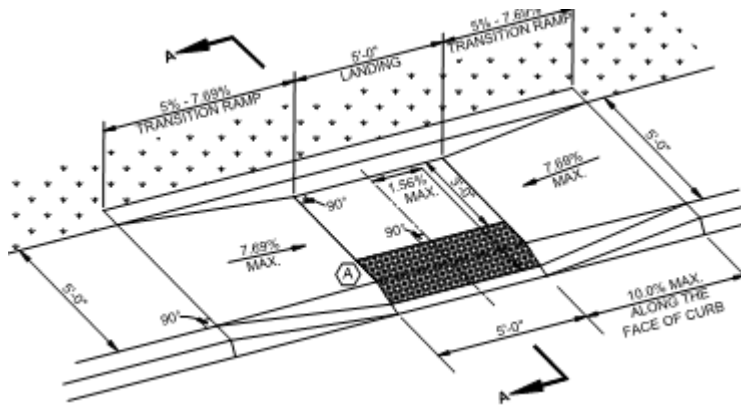

RAMP TYPE P-5

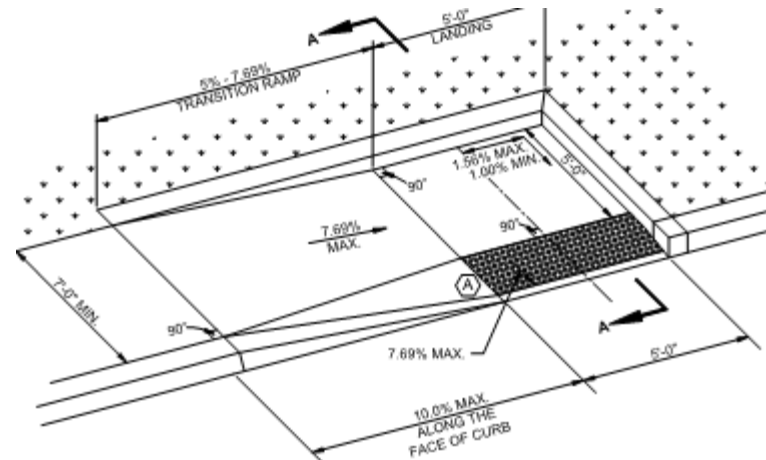

RAMP TYPE P-7

# Ramp Design Guidance

## Ramp Type

- TIER 3 (Rarely used ramps)

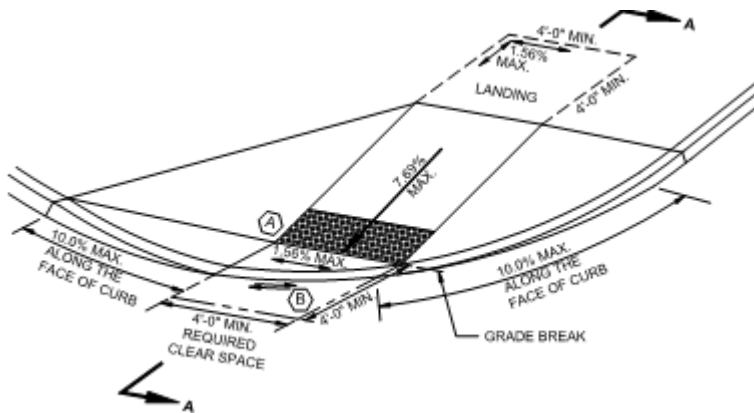

RAMP TYPE J

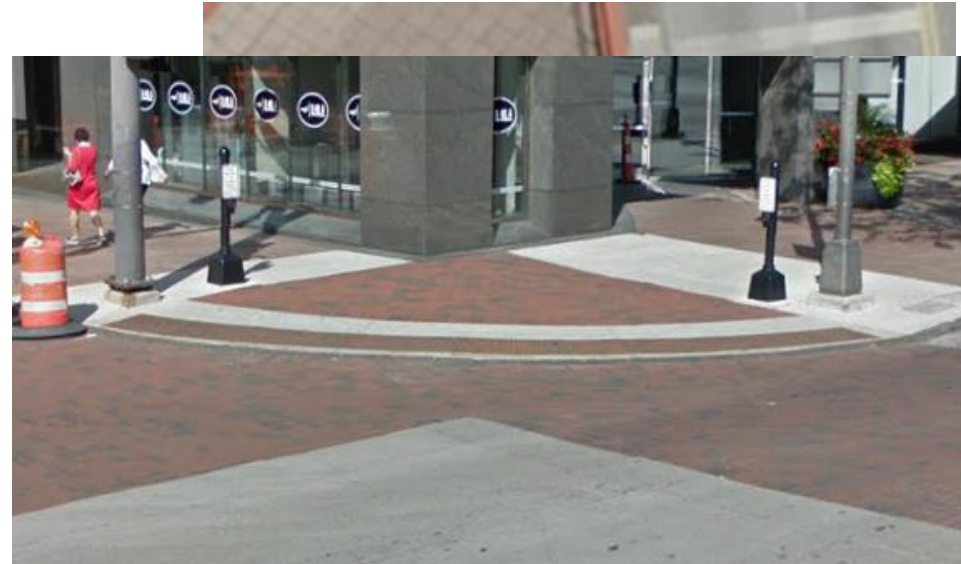

RAMP TYPE RADIAL

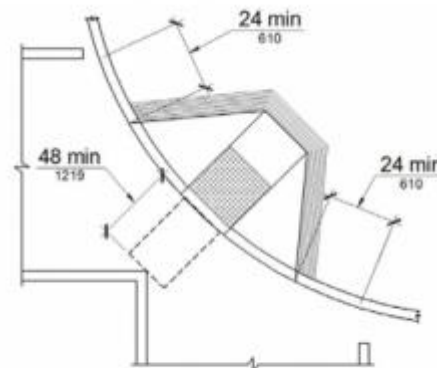

RAMP TYPE SINGLE SHARED RAMP



# Ramp Design Guidance

## Ramp Type

- SPECIALTY RAMPS (Alleys and Medians)

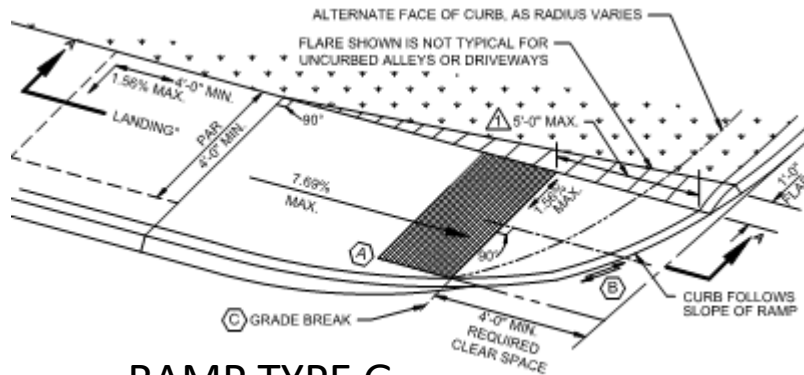

RAMP TYPE G

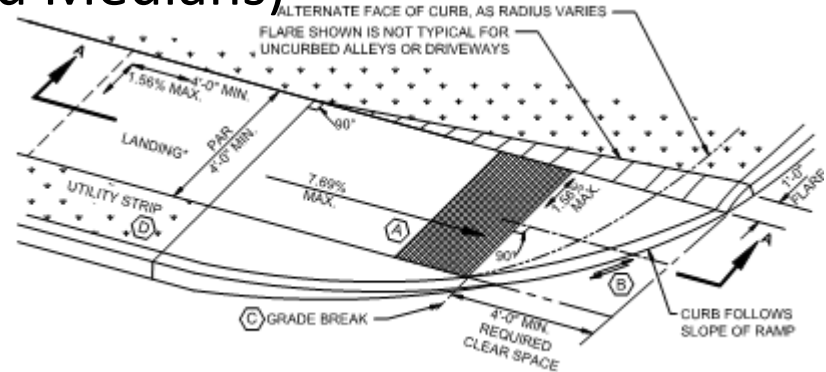

RAMP TYPE H

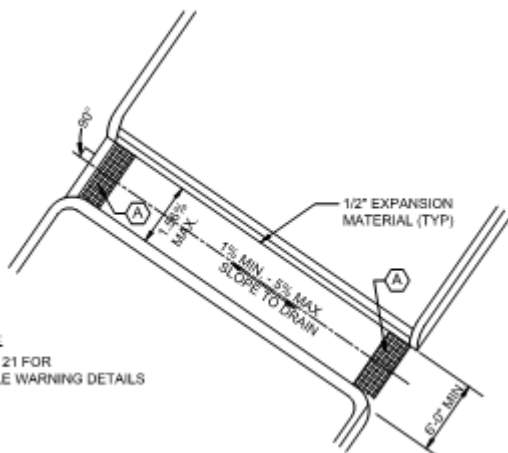

SEE  
SECTION 21 FOR  
STANDARD WARNING DETAILS

RAMP TYPE L-1

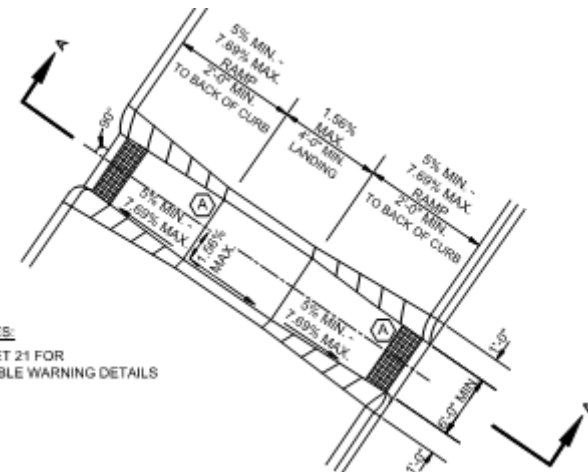

NOTES:  
SEE SECTION 21 FOR  
STANDARD WARNING DETAILS

RAMP TYPE L-2

# Ramp Design Guidance

## Ramp Type

- Specialty Ramps (Pedestrian Pads)

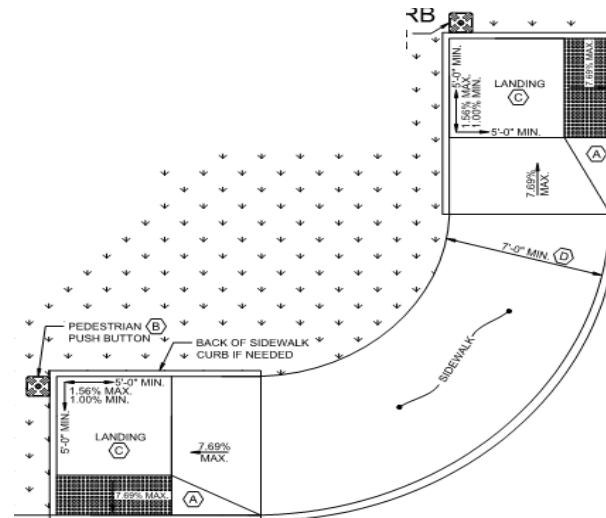
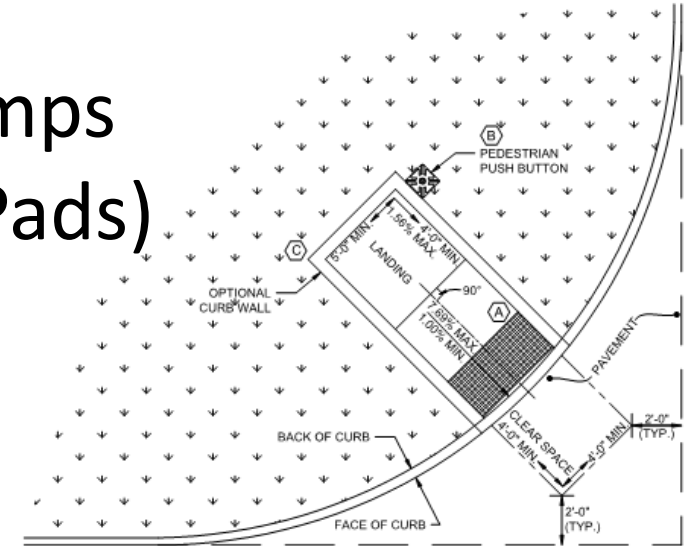
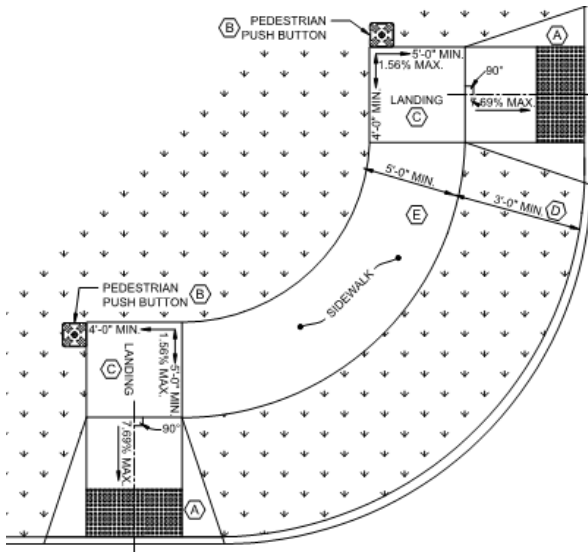

# Ramp Design Guidance

## Ramp Type

### Brick Ramps

- Used in historic districts with brick sidewalks

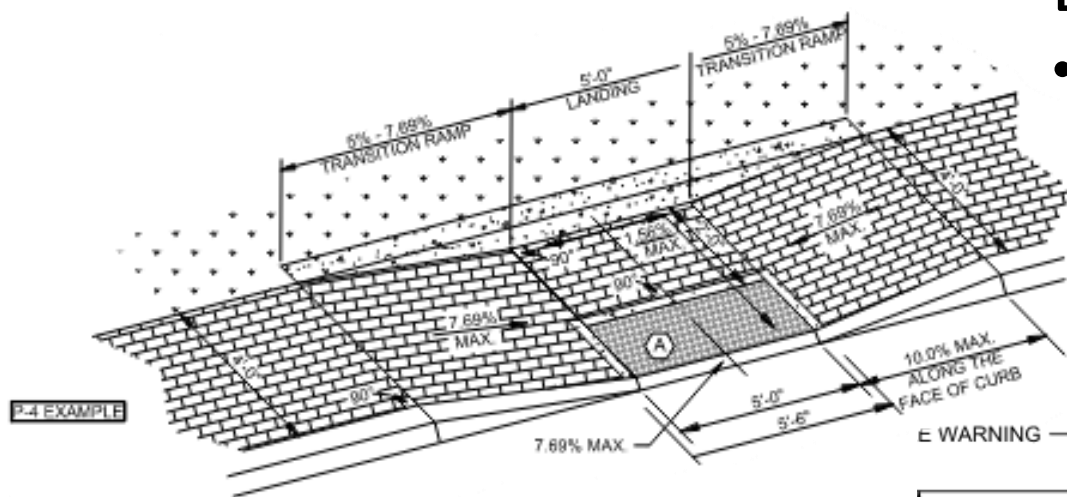

- Used in new construction anywhere brick sidewalk is adjacent

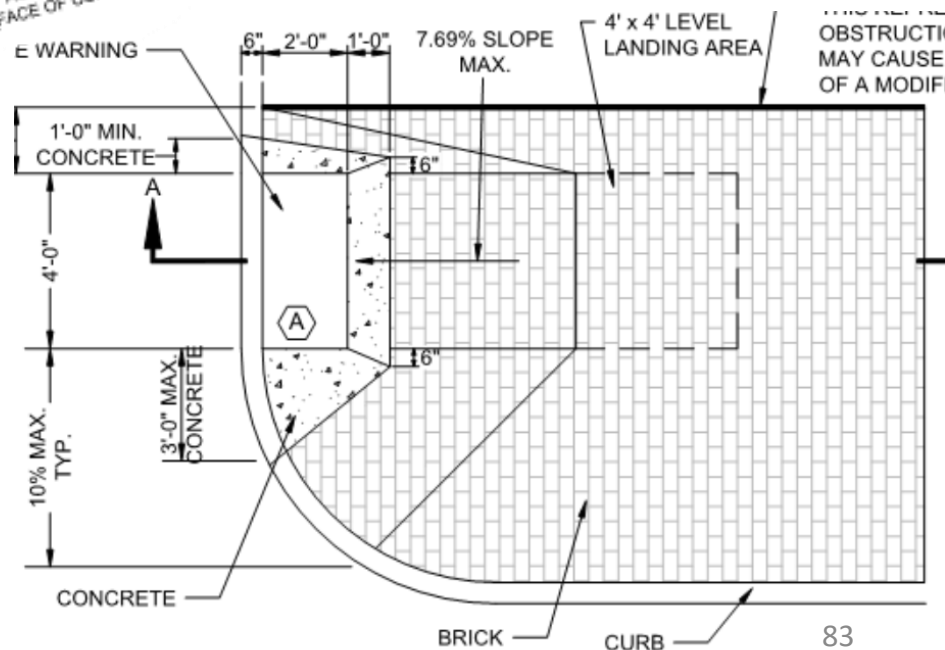

# Intersection Design

## Design Level



# Intersection Design

## Design Level – Full Design

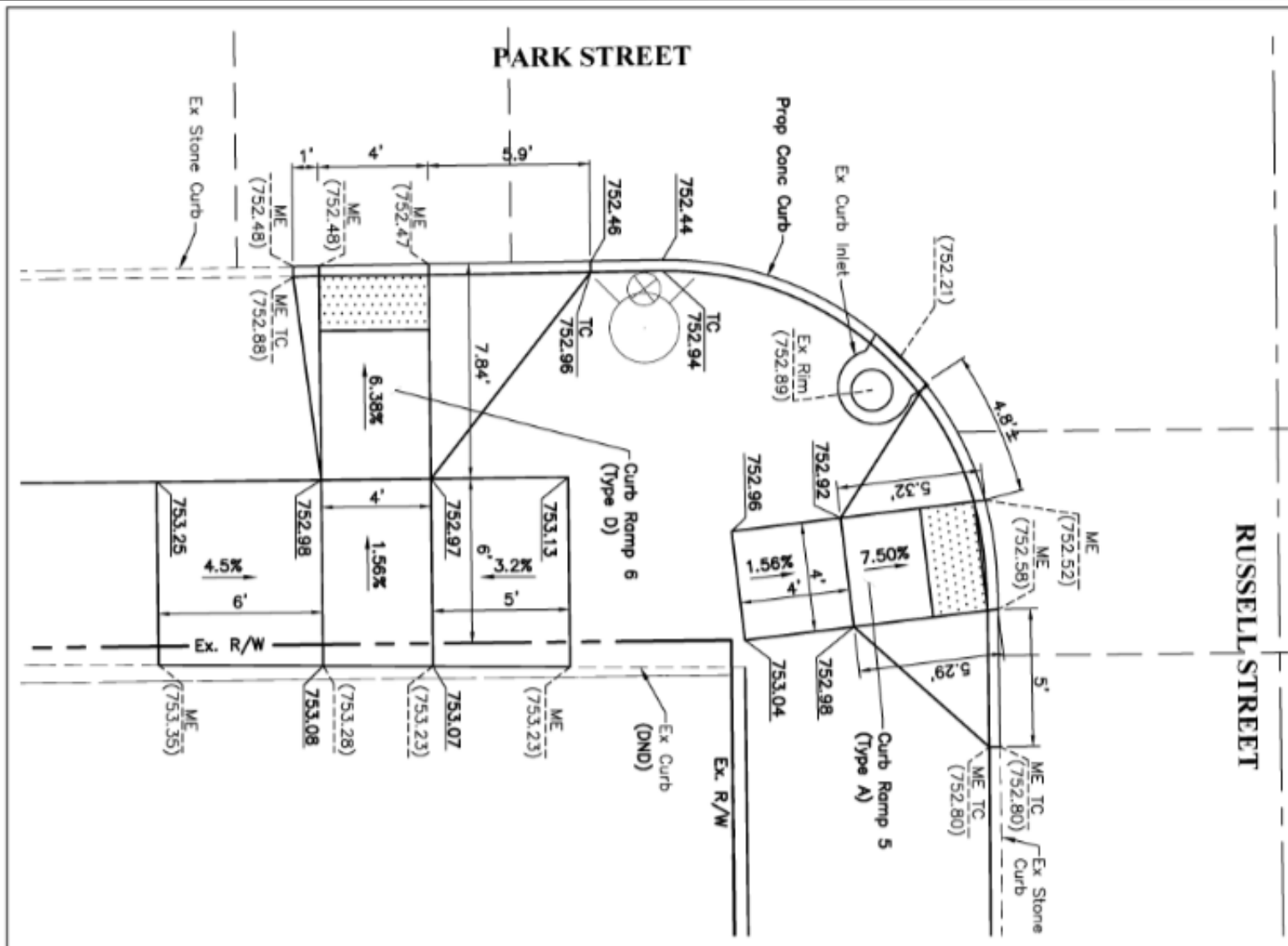

# Intersection Design

## Design Level

### Full Design

- These designs require TOPO.
- They show all grade breaks and elevations at all grade break intersections
- Right-of-way limits are shown
- All existing and proposed facilities are shown
- Pushbutton location is shown
- Typically these are shown in the intersection details section of the plans
- Default design for CIP projects and Private CC and E plan work

# Intersection Design

## Design Level - Design/Build

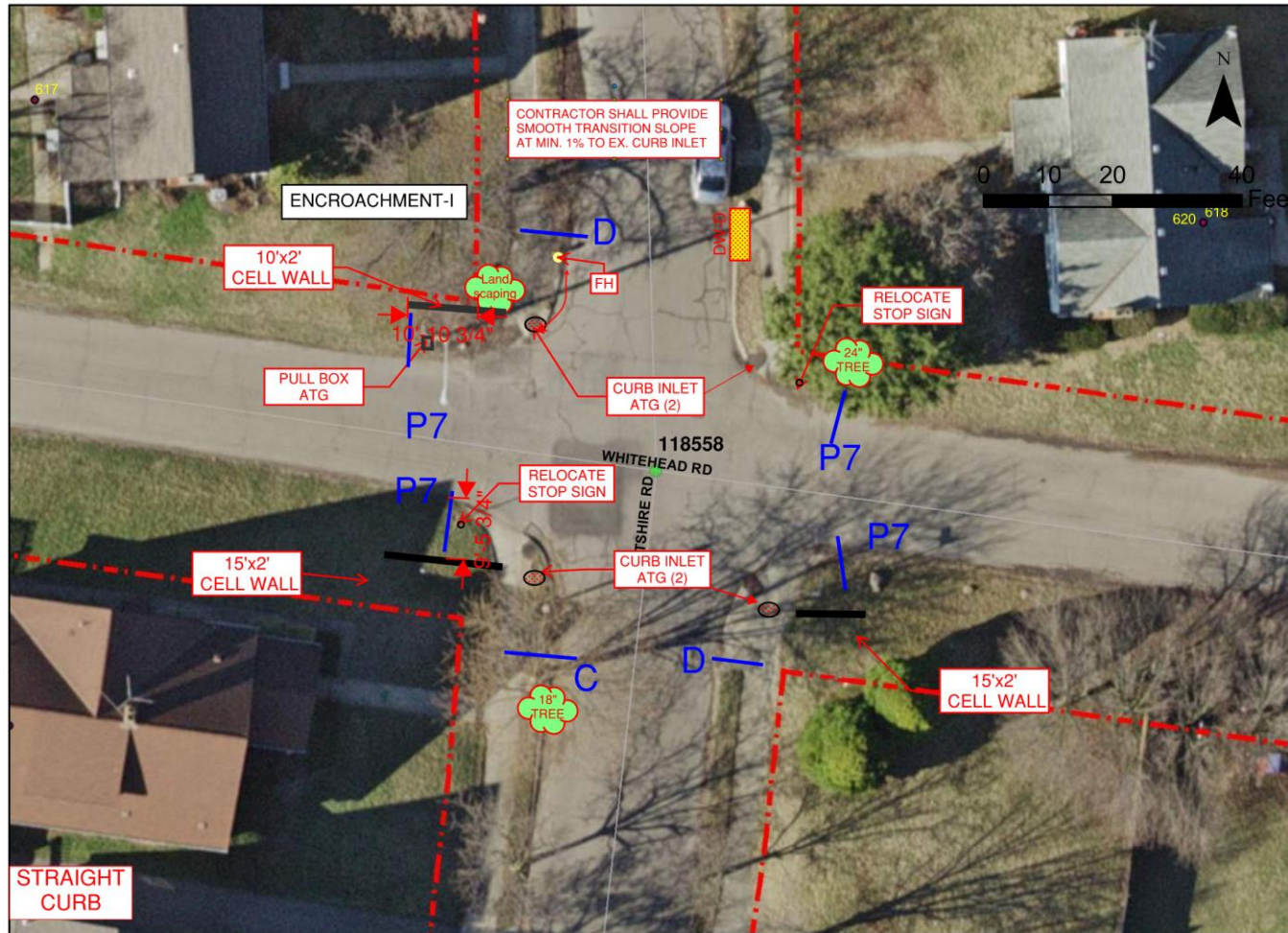

Document Path: J:\Design and Construction\Design\In-House Design\Admin\GIS\CB\BASE MAP.mxd

DESIGN: 2022 CITYWIDE CURB RAMPS	INTERSECTION OF: WILTSHIRE RD & WHITEHEAD RD	CITY OF COLUMBUS DEPARTMENT OF PUBLIC SERVICE DIVISION OF DESIGN AND CONSTRUCTION IN-HOUSE DESIGN	THE CITY OF <b>COLUMBUS</b> ANDREW J. GINTHER, MAYOR DEPARTMENT OF PUBLIC SERVICE
-------------------------------------	---	--	---

# Intersection Design

## Design Level

### Design-Build

- Uses an aerial orthographic photo as the base drawing
- Designer determines the ramp type and centerline location of the proposed ramp
- Right-of-way limits are shown, all acquisition must be complete before construction
- All existing facilities are shown with direction on how they are dealt with. I.E relocating stops sign, encroachments, etc...
- Ramp should be designed from the roadway edge back and also needs to accommodate existing sidewalk connections like lead walk and driveways



# Intersection Design

## Design Level

### Design-Build (cont.)

- Only for alteration projects
- Default design for In House Design projects
- May be used for private utility projects or private property improvements
- Very limited use on CIP projects and only based on advanced approval given at the scoping stage
- City always maintains the right to require a full design

# Intersection Design

## Design-Build Construction Responsibilities

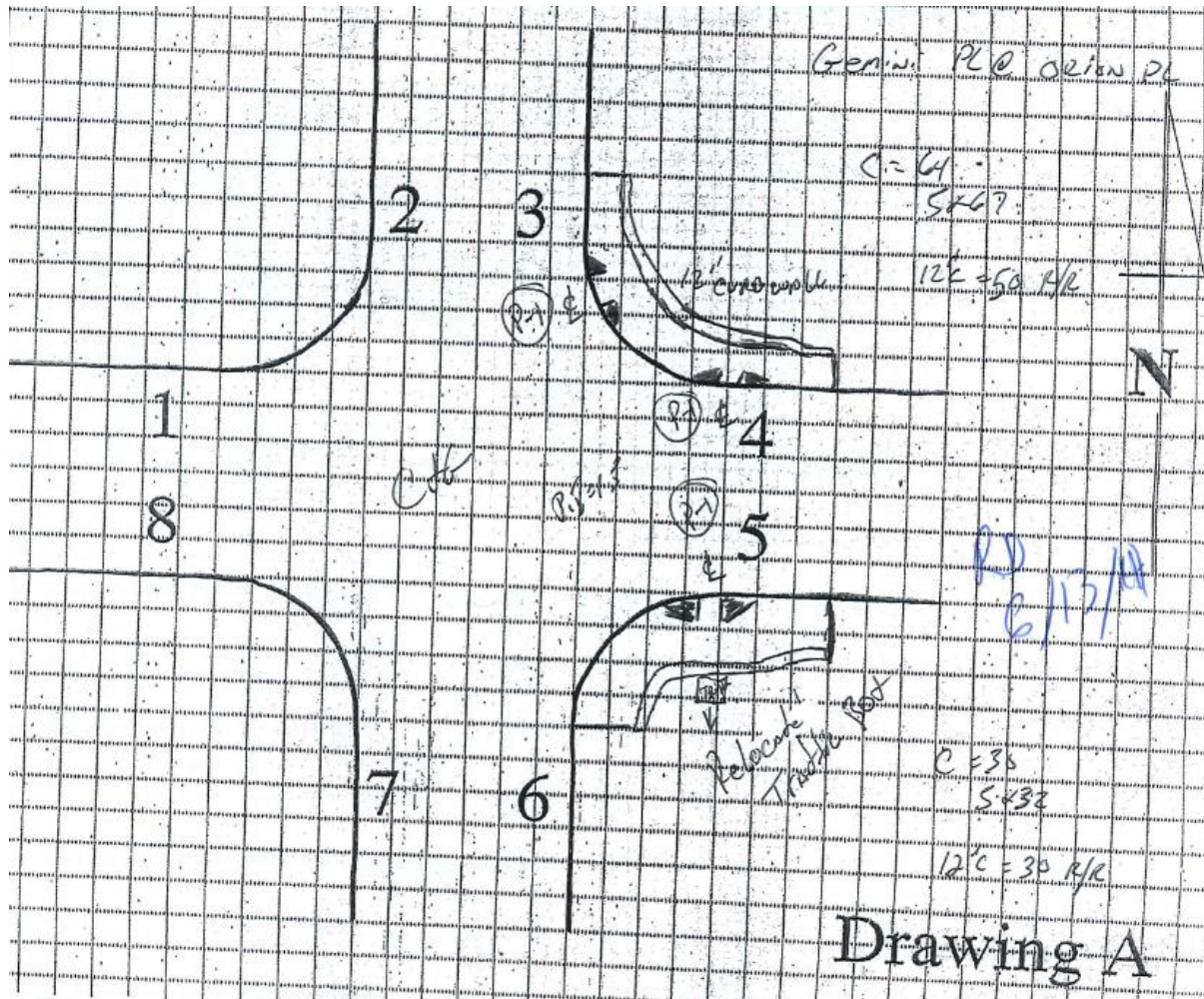

Contractor  
sketch

# Intersection Design

## Design Level

### Design-Build Construction Responsibilities

- The contractor visits the site and generates a sketch for approval by the Project Manager (PM)
- The PM reviews and approves the submittal, looking at deviations from the original design and quantities
- The contractor is responsible for building a compliant ramp and transition to existing sidewalk
- The contractor completes and signs off to a compliance form. Inspection spot checks.

# Intersection Design

## 3-Way (Tee) Intersections

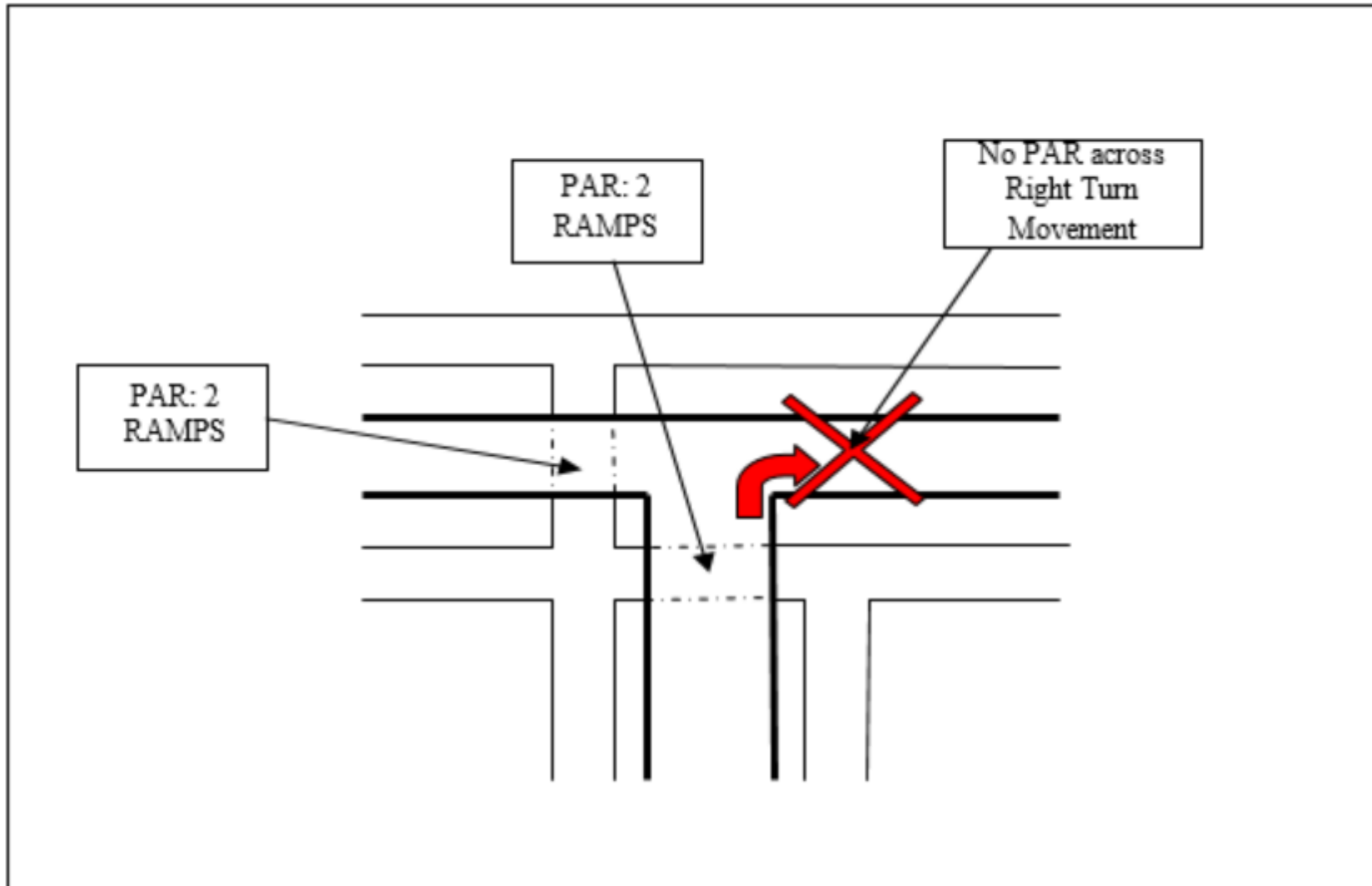
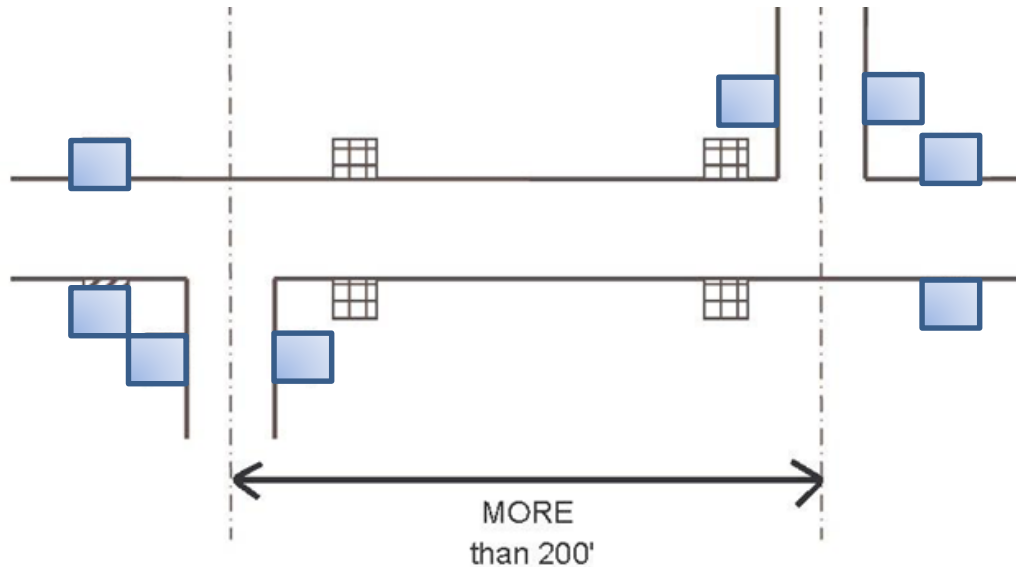

Figure 8-1

# Intersection Design

## 3-Way (Tee) Intersections

When the distance between the two legs of the offset exceed 200', the configuration now reflects a situation where there are actually two "tee", or 3-way intersections, and procedures for offset intersections will not be used. The design procedures for 3-way intersections will be utilized to determine the number and location of ramps for each of the two intersections



-  - Preferred Ramp Location
-  - Alternate Ramp Location



# Intersection Design

## Unsignalized Arterial Intersections

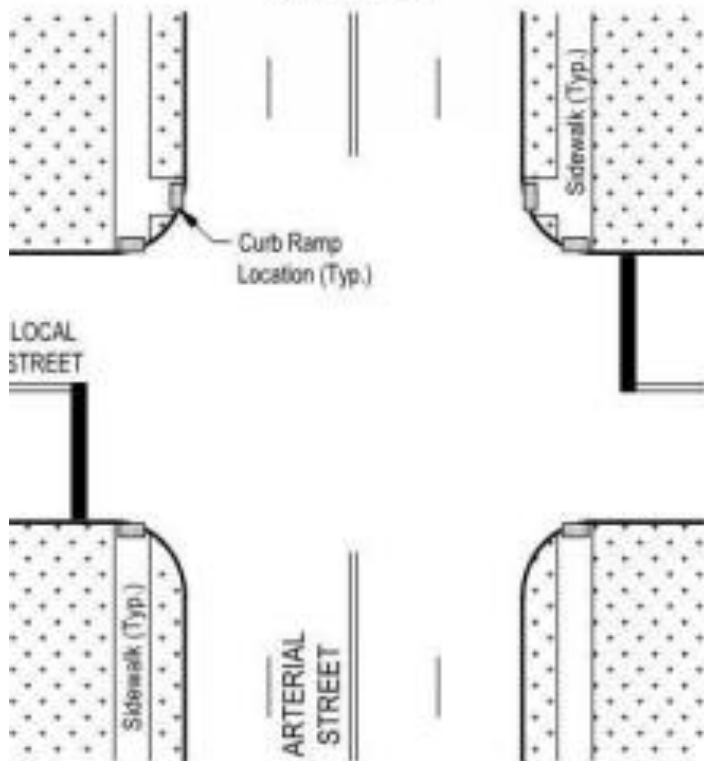
NON-SIGNALIZED ARTERIAL INTERSECTION  
WITH NON-ARTERIAL CROSSING STREET  
(6 REQUIRED)



### LEGEND

-  Curb Ramp w/ Detectable Warning
-  Stop Bar for Signal or Stop Sign

### G. Unsignalized Arterial Intersections.

Unsignalized crossings of arterial streets will have paired ramps crossing the arterial on one side of the intersection and ramps crossing the side street on both sides of the arterial. Signalized arterial intersections will receive ramps crossing all legal crosswalks. Refer to [Figure 8-6](#).

# Intersection Design

## Orphan Ramps

- In General, we want fully compliant and connected crosswalks
- This means ramps almost always come in pairs.
- Avoid building a ramp on one side of the street and not the other where sidewalk or a pushbutton exists on both sides
- Do not place ramps that connect to nothing
- A single ramp still serves as access to sidewalk

# Intersection Design

## Orphan Ramps

*R. Orphan Ramp* - Also known as unmatched ramp. This means a ramp which provides access to a legal crosswalk for which there is no corresponding ramp on the opposite end that allows a disabled pedestrian to exit the crosswalk and access an existing sidewalk.

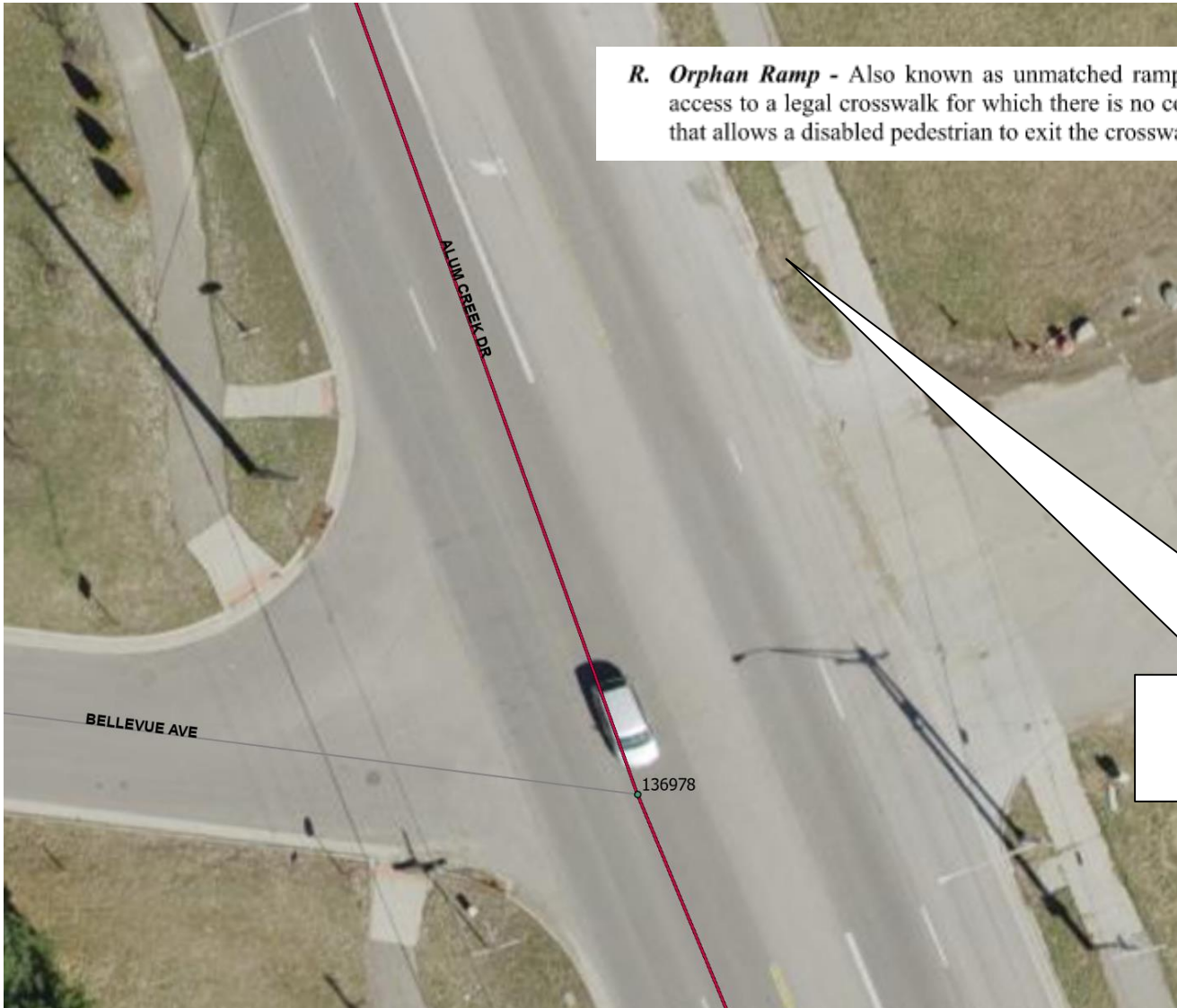

Ramp on east side of Alum Creek Dr is missing



# Pushbuttons

- Current Columbus Pushbutton placement – order of preference

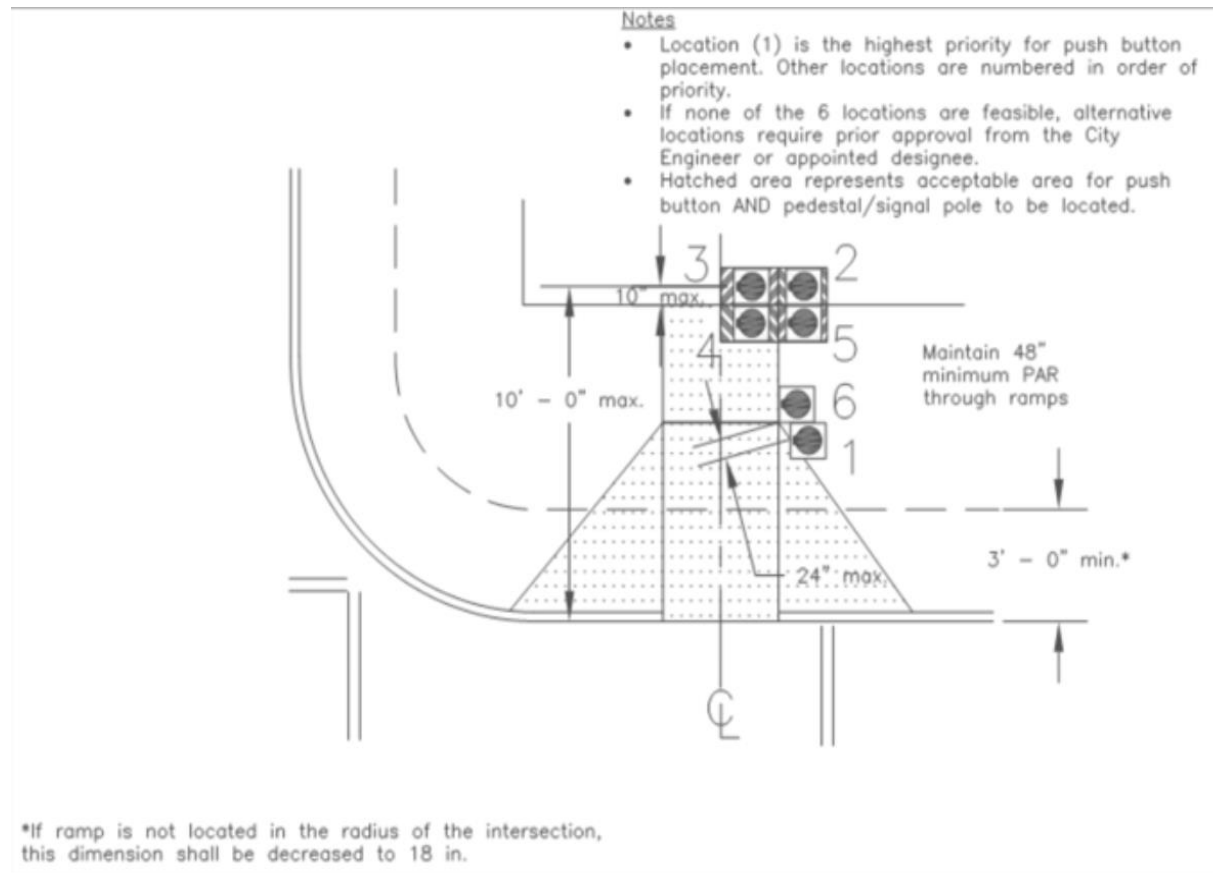

# Pushbuttons

## Parallel Ramp

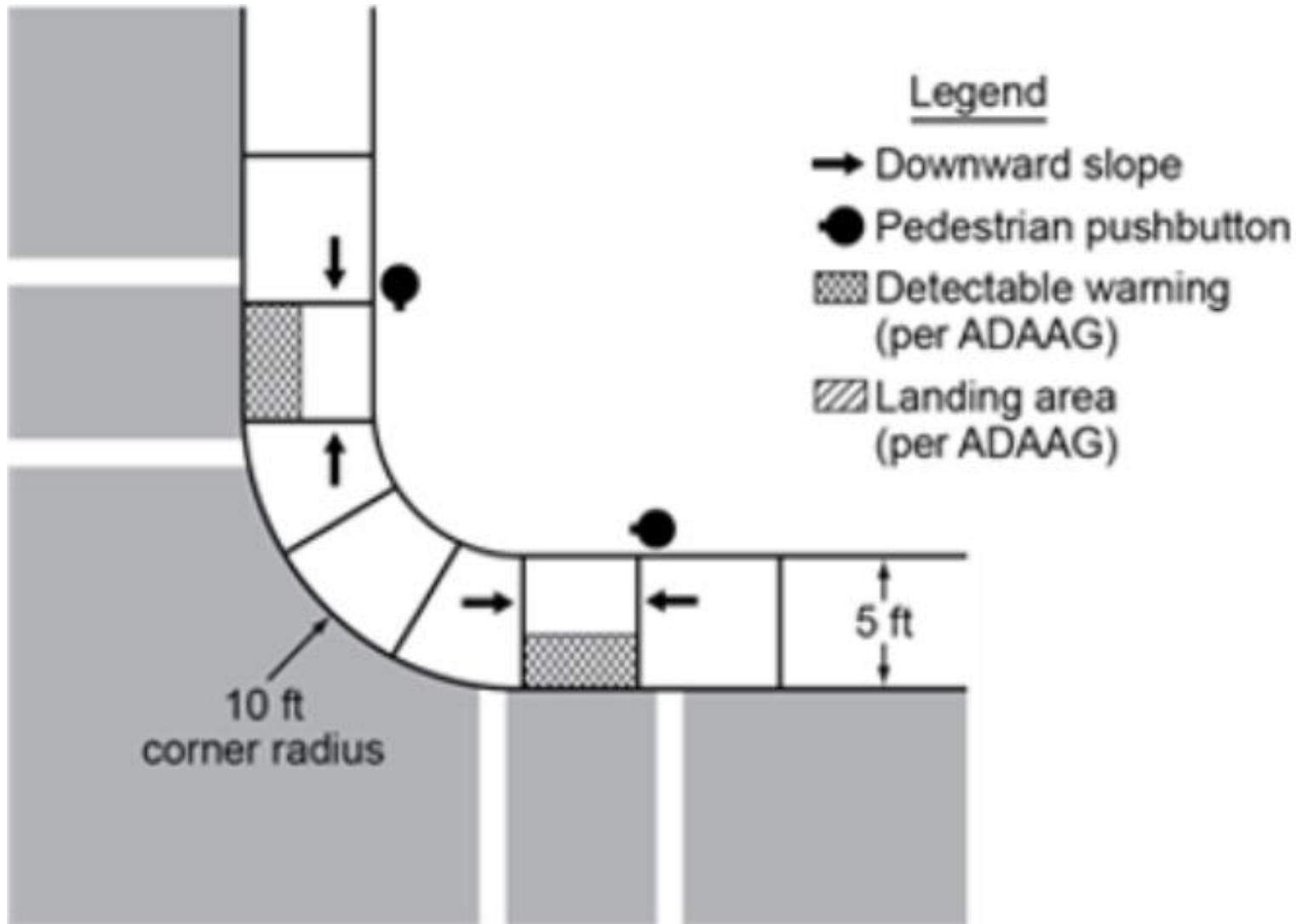

# Pushbuttons

## APS

- Accessible Pedestrian Signals (APS)
  - APS will not be required at all traffic signals
  - All new traffic signal builds will incorporate conduit for the easy future additional of APS.



# Pushbuttons

## Pushbuttons

- We also require that 2 pushbuttons on the same corner be separated by at least 10'
- This makes the button positions compliant for future APS use

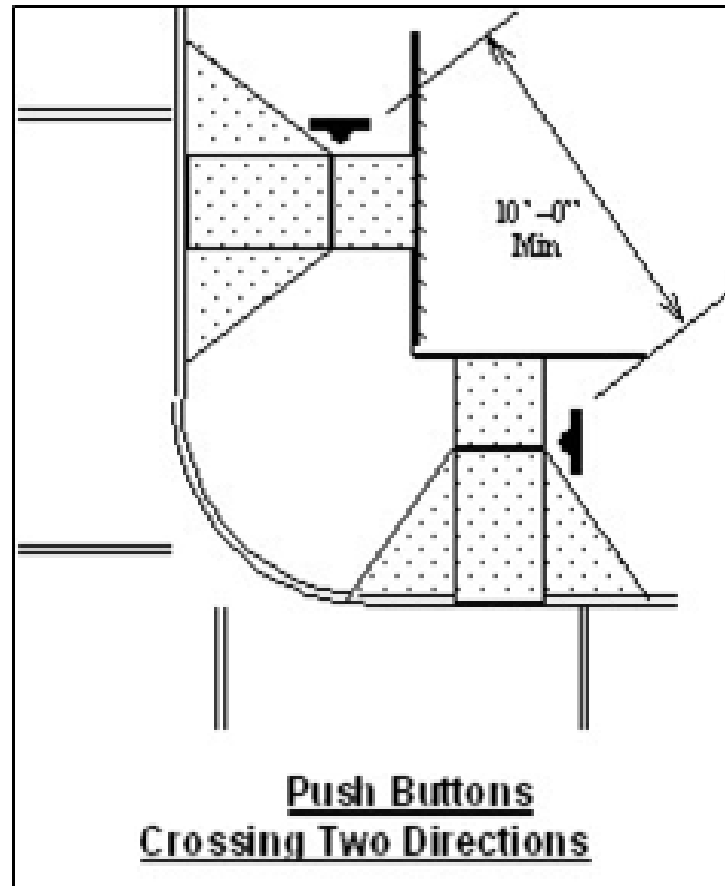

# Pushbutton Fails

Minimum dimensions are 4 ft by 4 ft. The pushbutton clear space may overlap a curb ramp turning space. ***Be on the lookout for obstructions such as curb, slopes, guardrail, or unimproved surfaces that may obstruct access to the pushbutton assembly.***



# ADA On Street Parking

- 4% of all individually marked or metered on street parking spaces must be designated ADA
- Unless specifically scoped to do so, the City is no longer marking individual parking spaces with transverse stripes
- The DPS Division of Traffic Management is responsible for managing parking zones and ensuring 4% of metered parking spaces are ADA

# ADA On Street Parking

- Projects making alterations to parking will trigger compliance
- Streetscape projects will be the most common
- ADA parking spaces should always be located at the end of the block, closest space to an existing ramp, and on the more minor street of the intersection

# Design Exceptions





# Design Exceptions

- Design exceptions should not be required for “New Construction” projects
- PARs and Ramps shall be designed and constructed to be 100% compliant unless they have received a documented design exception from the DPS Design Section Manager
- For alterations, all “technically feasible” options shall be considered prior to asking for a design exception.

# Design Exceptions

Technically infeasible path

- When it is technically infeasible to provide a compliant PAR triggered by an alteration, it may be necessary to sign the ADA compliant path
- This must go through the design exception process
- Signage must be placed to follow the complete alternate pathway, just like a roadway detour

# Design Exceptions

Technically infeasible path



# Design Exceptions

Technically infeasible path

- This sign indicates the alternate path for disabled persons to use
- It does not restrict pedestrians from using the ADA non-compliant route



CR-418

18"

# Design Exceptions

## Technically infeasible path

- This sign restricts access to ALL pedestrians
- It should only be used where a crosswalk is not safe for **ANYBODY** to cross
- Use of this sign should be approved by the DPS Division of Traffic Management



R9-3

# Design Best practices

- A design best practices section has been added to the ADA Rules and Regulations
- This describes the City's preferences that aren't hard and fast rules
- The best practices should always be followed unless there is a reason why they can't be

# Issue: Ramp drainage



# Maintain Gutter drainage



- Construct the ramp to meet the roadway edge.
- Do not adjust the road later to meet the ramp
- The curb no longer drains along the gutter in this example
- Heatwelding is often an obvious sign of post construction adjustment



# Design Best practices

Ramps inherently are a minimum slope of 5%, otherwise, they are considered blended transitions.

- ALL PERPENDICULAR RAMPS SHALL HAVE A LANDING NO LESS THAN 4-FT MINIMUM BY 4-FT. A PERPENDICULAR RAMP THAT IS CONSTRAINED AT THE BACK OF SIDEWALK SHALL HAVE A LANDING 4-FT BY 5-FT. THE 5-FT DIMENSION SHALL BE PROVIDED IN THE DIRECTION OF RAMP RUN, AS SHOWN IN THESE STANDARD DRAWINGS.
- LANDING AT INTERSECTING SIDEWALKS - WHEREVER SIDEWALKS INTERSECT, THERE SHALL BE A LANDING.
- 7. STREET COUNTER SLOPE: THE COUNTER SLOPE AT THE BASE OF THE RAMP SHALL BE A MAXIMUM OF 5% FOR A MINIMUM OF 2-FT.
- 8. CLEAR SPACE: AT MARKED CROSSINGS THE RAMP AND STREET CLEAR SPACE MUST BE FULLY CONTAINED WITHIN THE MARKED CROSSWALK. AT UNMARKED CROSSINGS THE RAMP AND CLEAR MUST BE WITHIN THE CURB RAMP DESIGN BOUNDARY.
- 9. SURFACES: RAMP, FLARE, AND LANDING SURFACES MUST BE STABLE AND SLIP RESISTANT. RAMPS SHALL BE BROOM FINISHED, TRANSVERSE TO THE DIRECTION OF TRAVEL. GRATINGS, VALVE BOXES, AND UTILITY BOXES SHALL NOT BE LOCATED IN THE RAMP OR LANDING.
- 10. DETECTABLE WARNINGS: DETECTABLE WARNINGS SHALL BE INSTALLED ACCORDING TO THESE STANDARD DRAWINGS, CMSC 608, AND DPS ADA RULES AND REGULATIONS.
- 11. CURB WALLS MAY BE NECESSARY FOR CURB RAMP CONSTRUCTION WHERE SPACE RESTRICTION DO NOT ALLOW FOR GRADING WITHIN ROW AT A 3:1 SLOPE OR FLATTER. THE MAXIMUM HEIGHT OF 6" THICK, NON-REINFORCED CURB WALL IS 12" ABOVE THE SIDEWALK SURFACE. THE BURIED PORTION OF THE NON-REINFORCED CURB WALL SHALL BE EQUAL TO THE EXPOSED REVEAL. RETAINING EMBANKMENT TO A HEIGHT OF MORE THAN 12" ABOVE THE SIDEWALK WILL REQUIRE A DESIGNED RETAINING WALL OR CELLULAR WALL.
- 12. RAMPS MUST BE CONSTRUCTED TO ALLOW FOR POSITIVE DRAINAGE. THE RAMP ITSELF SHALL NOT HOLD EXCESS WATER AND THE ADJACENT PAVEMENT SHALL NOT BE ALTERED TO INHIBIT FLOW OF WATER. IF AN EXISTING CONSTRAINT PREVENTS BUILDING THE RAMP AND ADJACENT AREA WITH POSITIVE DRAINAGE IT MUST BE BROUGHT TO THE CITY'S ATTENTION PRIOR TO CONSTRUCTION AND FINAL DESIGN APPROVED BY THE CITY.

12. RAMPS MUST BE CONSTRUCTED TO ALLOW FOR POSITIVE DRAINAGE. THE RAMP ITSELF SHALL NOT HOLD EXCESS WATER AND THE ADJACENT PAVEMENT SHALL NOT BE ALTERED TO INHIBIT FLOW OF WATER. IF AN EXISTING CONSTRAINT PREVENTS BUILDING THE RAMP AND ADJACENT AREA WITH POSITIVE DRAINAGE IT MUST BE BROUGHT TO THE CITY'S ATTENTION PRIOR TO CONSTRUCTION AND FINAL DESIGN APPROVED BY THE CITY.

## CURB RAMP GENERAL NOTES

CITY OF COLUMBUS, OHIO  
DEPARTMENT OF PUBLIC SERVICE  
DIVISION OF DESIGN AND CONSTRUCTION

STD DWG

2319

3/30/2018

SHT 3 OF 21

# Design Best practices

## Tier 1 Ramps

Minimize the ramp length and maximize the running slope to increase drainage

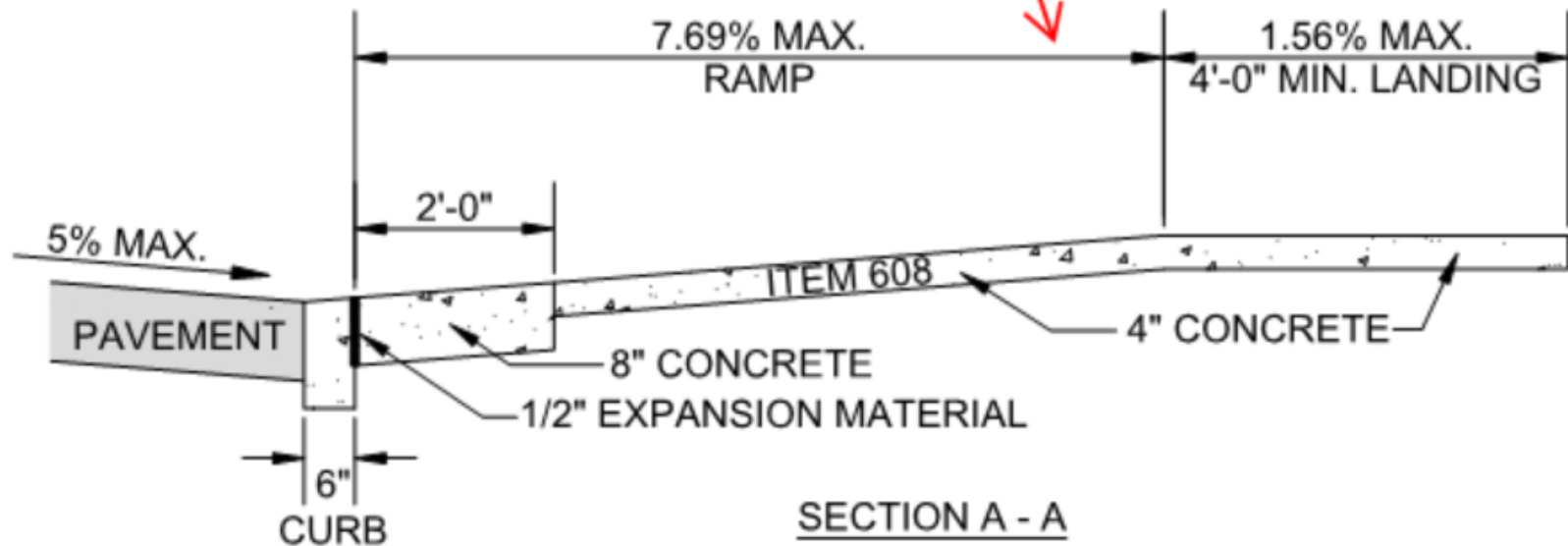

# Design Best practices

## G & H Ramps AKA Alley Ramps

Maximize the ramp slope and ensure 1% minimum drainage in all directions at the bottom of the ramp after the grade break

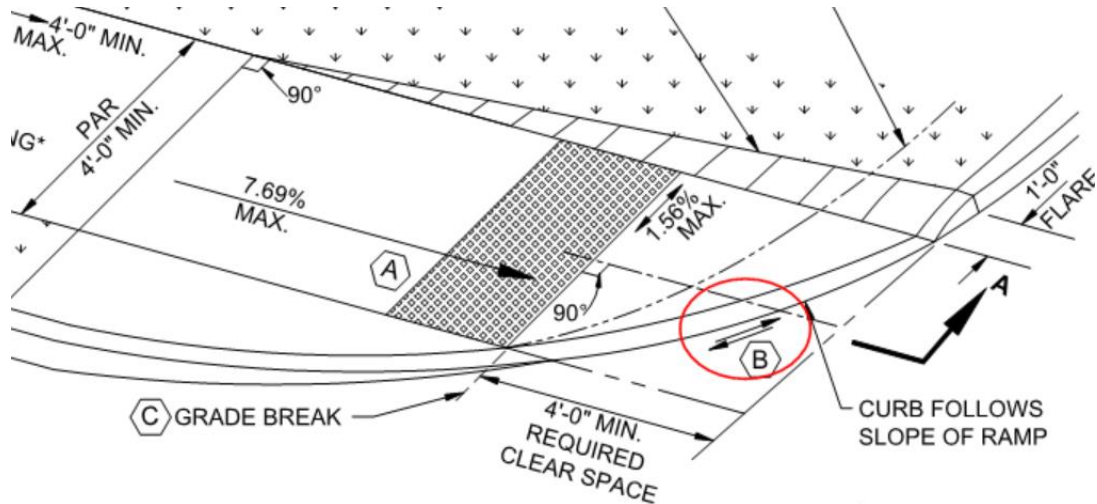

### CODED NOTES:

- A** SEE SHEET 21 FOR DETECTABLE WARNING DETAILS
- B** PROVIDE POSITIVE DRAINAGE ALONG CURBLINE, SHOULD BE 1.00% MINIMUM SLOPE
- C** WHERE THE DISTANCE FROM EITHER END OF THE BOTTOM OF THE GRADE BREAK TO THE BACK OF CURB IS GREATER THAN 5-FT, THE DETECTABLE WARNING SHALL BE PLACED AT THE BACK OF CURB

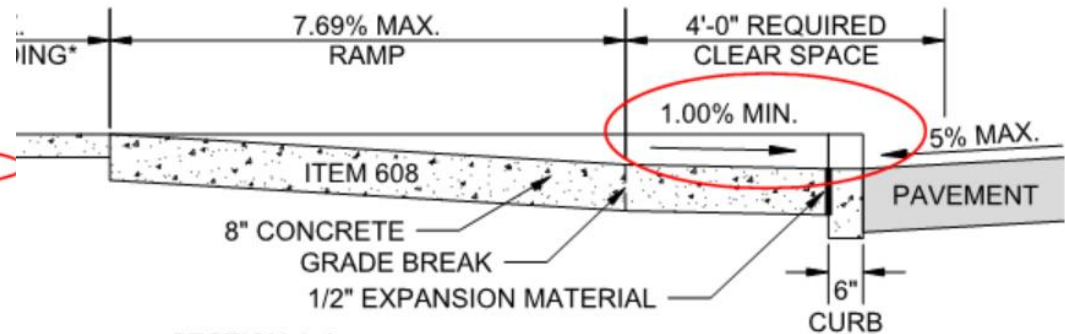

SECTION A-A

# Design Best practices

## Parallel (P) Ramps

- Parallel ramps often collect water because the landing is lowered closer to street level.
- The narrower the sidewalk is for the parallel ramp, the less ability there is to slope up from the street
- It is critical to maximize the ramp running slope available to provide the best drainage possible.
- The 2319 SCDs detail how to maximize landing elevation above the street

# Design Best practices P-6 and P-7 ramps

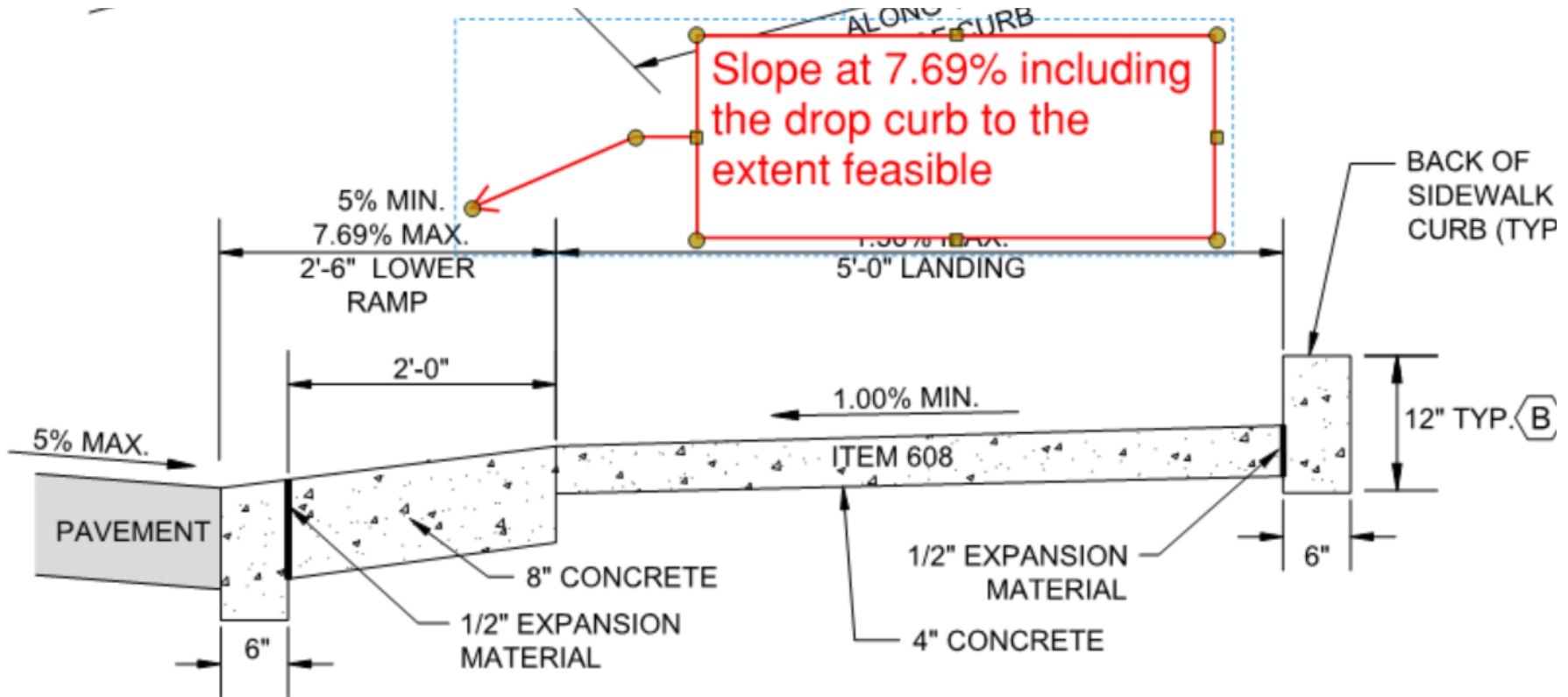

SECTION A-A

# Design Best practices

## P5 ramp

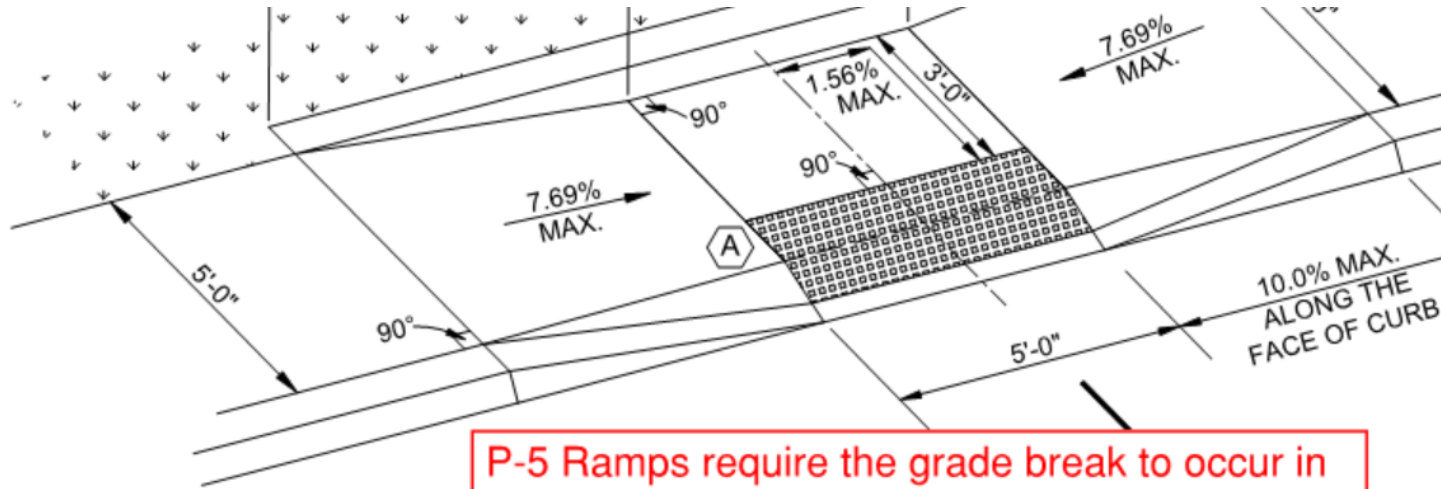

P-5 Ramps require the grade break to occur in the detectable warning area. This requires stick on detectable warnings

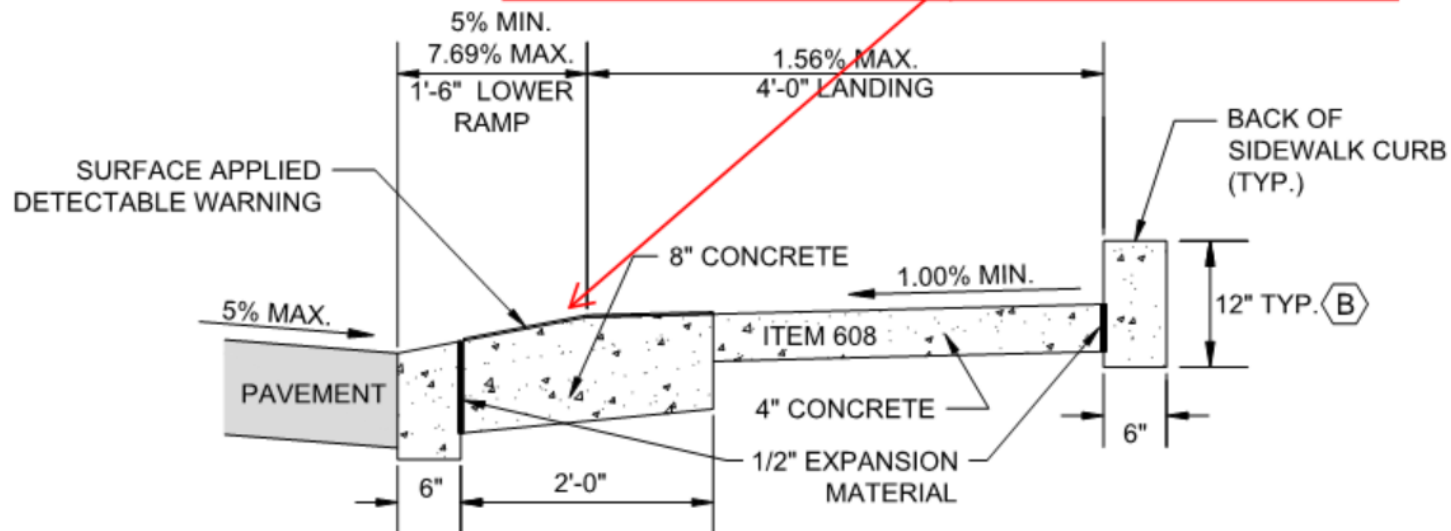

# Design Best practices

## P4 ramp

P4 Ramps are the most difficult to drain and only used when this is the only ramp that can be constructed without acquiring Right of Way

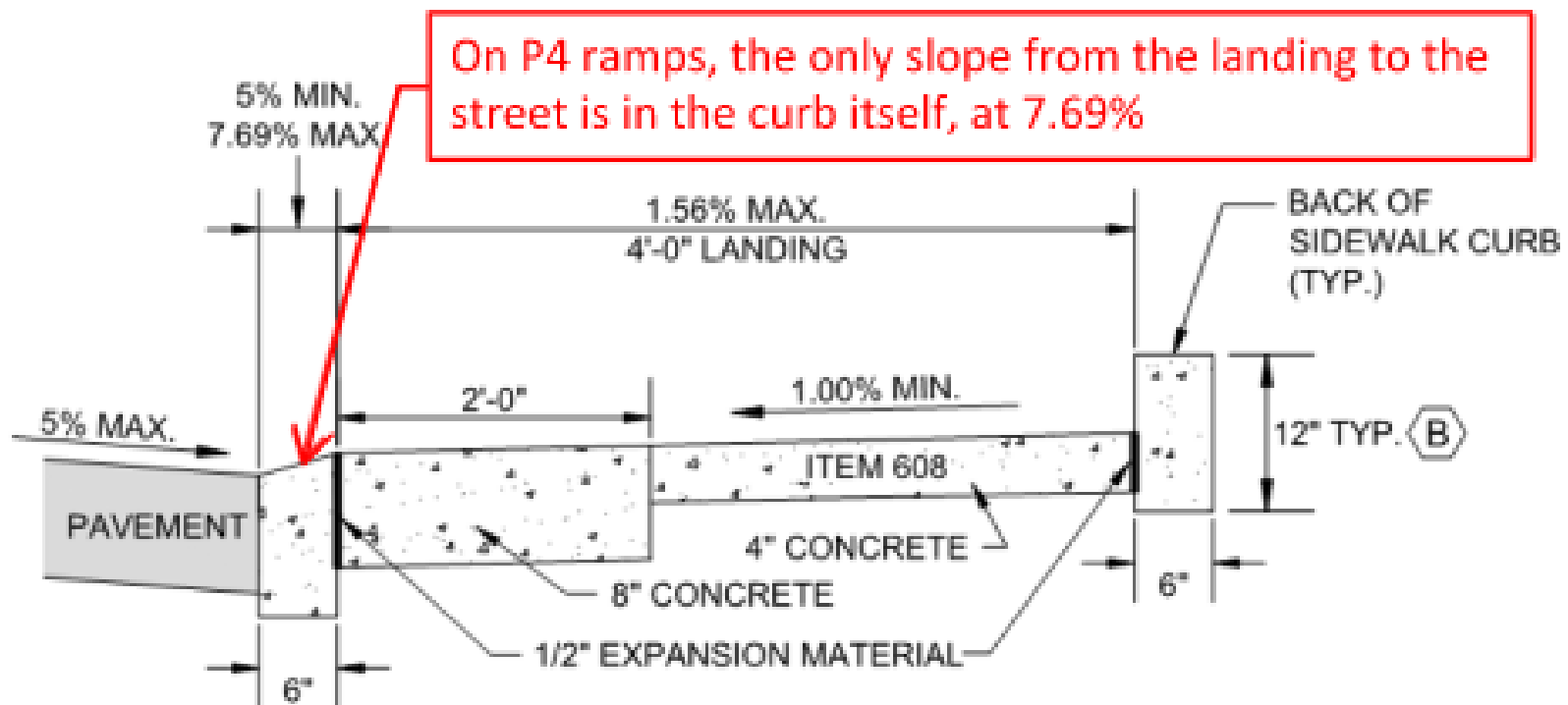

# Design Best practices

## Use of D ramps vs. C ramps



- Provide a walking surface to accommodate both wheelchairs and the able bodied.
- D Ramps provide this



# Design Best practices

## Use of D ramps vs. C ramps

- Minimize small grass patches



# Design Best practices

## Curb Walls and Work Agreements

- Minimize use of walls behind sidewalk. Grade back whenever possible to a maximum 3:1 slope



# Design Best practices

## Curb Walls and Work Agreements

- Work agreement would have avoided this



# Design Best practices

## Curb Walls and Work Agreements

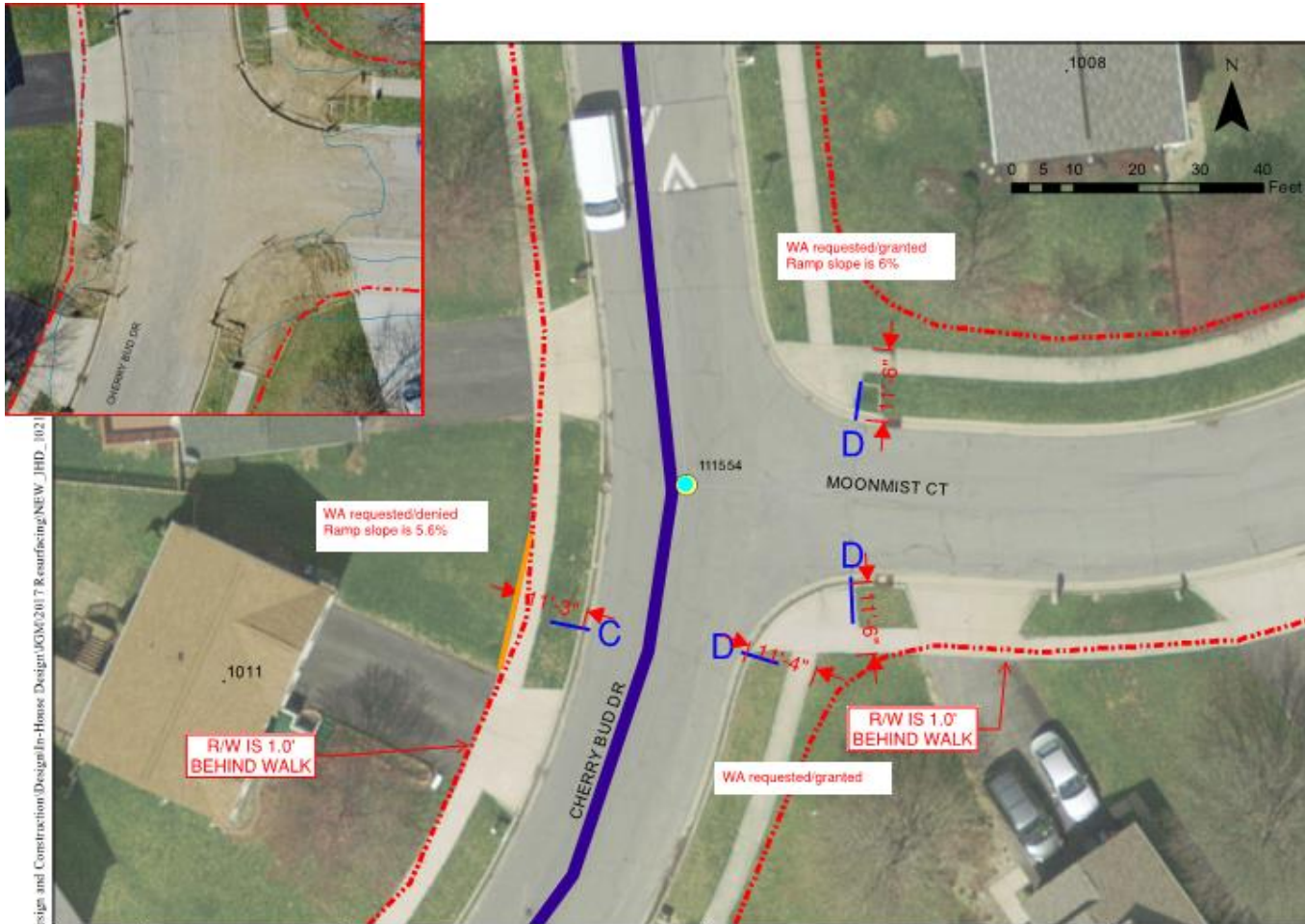

Document Path: F:\Design and Construction\Design-In-House Design\KMC\2017 Resurfacing\NEW\_JHD\_1021

DESIGN: <b>JGM</b> 05/27/2016	PROJECT NAME: 2017 RESURFACING PROJECT 1	INTERSECTION OF: <b>CHERRY BUD DR &amp; MOONMIST CT</b>	CITY OF COLUMBUS DEPARTMENT OF PUBLIC SERVICE DIVISION OF DESIGN AND CONSTRUCTION IN-HOUSE DESIGN	THE CITY OF <b>COLUMBUS</b> ANDREW J. GINTHER, MAYOR DEPARTMENT OF PUBLIC SERVICE
-------------------------------------	---	--	--	---

# Design Best practices

## Cell Walls



- Cell walls are used when the height is greater than 18” and up to 48”; In resurfacing projects, we note Versa-lok should be used.

# Design Best practices

## Signs



- Avoid blocking the PAR with signs

# Pedestrian MOT & Compliance

THE CITY OF  
**COLUMBUS**  
ANDREW J. GINTHER, MAYOR

DEPARTMENT OF  
PUBLIC SERVICE



# Pedestrian MOT

- Consider the pedestrian route when phasing construction.
- Before closing sidewalk to begin work, a pedestrian detour must be set up.
- Ensure signage is set up in all directions of traffic to allow pedestrians to follow the detour without doubling back
- Ensure the detour pathway is ADA compliant.



# Pedestrian MOT

Planning your  
MOT is critical

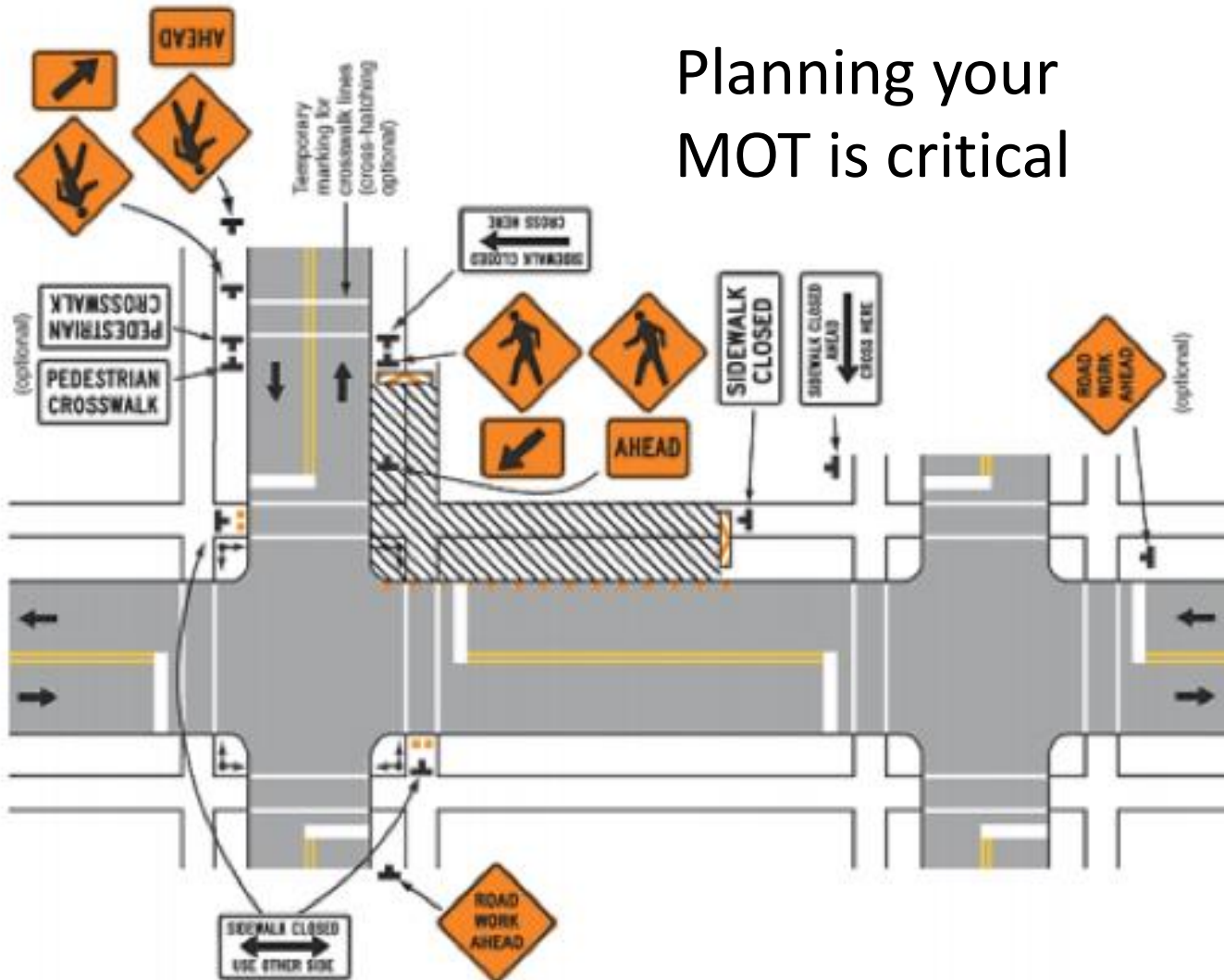

# Pedestrian MOT

## Common elements



# Pedestrian MOT

## Pathway

- Walkways shall be 5' in clear width
- If less than 5', passing Spaces of 5' x 5', every 200'
- Intrusion free



# Pedestrian MOT

This is not a detectable barricade for Pedestrian MOT



# Pedestrian MOT

## Detectable barricades for Pedestrian MOT



# Construction

- It is critical for Construction Inspection personnel to have an understanding of ADA compliance.
- Full design projects should require minimal direction during the construction of curb ramps.
- Design/Build Ramps require the inspector to review the contractor's submittal and approve them in the time specified by the contract.

## Curb Ramp Compliance Checklist

Reference: Standard Drawing 2319 (03/30/2018)-Curb Ramps

Project Name: \_\_\_\_\_ Inspection Date : \_\_\_\_\_

Intersection of : \_\_\_\_\_ and \_\_\_\_\_

Ramp No: \_\_\_\_\_

1)	Is a 4' wide pedestrian access route (PAR) maintained?	<input type="checkbox"/> YES	<input type="checkbox"/> NO
2)	Is there a minimum 4' x 4' landing adjacent to each ramp (P landing 4'x5')	<input type="checkbox"/> YES	<input type="checkbox"/> NO
3)	Landing slopes: max 2.08% (1/4"/ft.)	A) _____%	B) _____%
4)	Street counter slope at the base of the ramp: max 5.00%		_____%
5)	Ramp's running slope: max 8.33% (1:12)		_____%
6)	Ramp's cross slope: max 2.08% (1/4"/ft)		_____%
7)	Is there a detectable warning present?	<input type="checkbox"/> YES	<input type="checkbox"/> NO
8)	Is the maximum distance of concrete between the DW and edge of concrete or flares less than 6"? (if greater, comment distance)	<input type="checkbox"/> YES	<input type="checkbox"/> NO
9)	Is the detectable warning mat placed less than 8" behind the face of curb and curb joint?	<input type="checkbox"/> YES	<input type="checkbox"/> NO
10)	Are 95% of the truncated domes in the detectable warning mat intact?	<input type="checkbox"/> YES	<input type="checkbox"/> NO
11)	Is the detectable warning mat properly oriented? (perpendicular to the running slope)	<input type="checkbox"/> YES	<input type="checkbox"/> NO
12)	Is gutter line at the curb ramps draining properly and not holding water? (Look for evidence of sediment and make comments about the cause and suggested ponding repair)	<input type="checkbox"/> YES	<input type="checkbox"/> NO
13)	Are there any vertical discontinuities greater than 1/4"? (lips / offsets)	<input type="checkbox"/> YES	<input type="checkbox"/> NO
14)	Are short flares only used adjacent to non-walkable areas?	<input type="checkbox"/> YES	<input type="checkbox"/> NO
15)	Are ramps fully compliant?	<input type="checkbox"/> YES	<input type="checkbox"/> NO
16)	Photos Attached?	<input type="checkbox"/> YES	<input type="checkbox"/> NO

Please comment on any failures on second sheet.

Inspector Name : \_\_\_\_\_

Inspector Signature : \_\_\_\_\_

### Pushbutton Compliance Checklist

Reference: City of Columbus ADA Rules and Regulations April 2018

Construction Date : \_\_\_\_\_ Intersection ID \_\_\_\_\_  
Intersection of : \_\_\_\_\_ and \_\_\_\_\_  
Ramp # : \_\_\_\_\_

- 1) Are the signs installed accordance with standards/plan sheets?  YES  NO
  - 2) Is there a minimum 4'x4' landing adjacent to each push button?  YES  NO
  - 3) Distance from the face of push button to the face of curb: *18" – 10 ft.* \_\_\_\_\_ Ft. \_\_\_\_\_ In.
  - 4) Distance between push buttons: *10 ft. min* \_\_\_\_\_ Ft. \_\_\_\_\_ In.
  - 5) Push button height: *42" preferred (36" min / 46" max)* \_\_\_\_\_ Ft. \_\_\_\_\_ In.
  - 6) Push button side reach: *10" behind the landing, side reach 24"* \_\_\_\_\_ Ft. \_\_\_\_\_ In.
  - 7) Push buttons placed according to the plan details, oriented correctly?  
If no, please describe: \_\_\_\_\_  
\_\_\_\_\_
  - 8) Do all Push buttons light and beep when pressed?  
If no, please describe: \_\_\_\_\_  
\_\_\_\_\_
  - 9) Is foundation placed in walkable area?  YES  NO  
If yes, is the foundation flush with the surrounding walk?
  - 10) Is Push button fully compliant?  YES  NO  
If no, please describe: \_\_\_\_\_  
\_\_\_\_\_
  - 11) Additional Comments: \_\_\_\_\_  
\_\_\_\_\_  
\_\_\_\_\_
  - 12) Photos Attached  YES  NO  
Description: \_\_\_\_\_
- Inspector Name : \_\_\_\_\_  
Inspector Signature : \_\_\_\_\_



# Construction

- Contractors constructing ramps within Columbus ROW must identify an ADA Compliance Officer to take responsibility for compliance of all ramps constructed
- ALL ramps constructed will require a compliance form to be completed and signed by the ADA Compliance Officer.
- Compliance forms shall be maintained in the project records for any project building curb ramps.

# Construction

- Construction inspection shall spot check and complete compliance forms for least 10% of ramps for quality assurance
- If it is found an ADA compliance officer incorrectly calls a ramp compliant 3 times in a rolling 2 years, that individual will no longer be allowed to be designated as an ADA Compliance Officer in Columbus

# Construction Compliance verification

**608.07 Curb Ramps.** Excavate, form, place, finish, and cure according to [608.03.A](#), [608.03.B](#), [608.03.C](#), and [608.03.E](#). Finish ramps to a rougher final surface texture than the adjacent walk and with striations transverse to the ramp slope using a coarse broom or other method approved by the Engineer. This work shall consist of constructing curb ramps, including ramps, flares, landings, and sidewalk transitions, in accordance with lines, grades and dimensions shown on the plans or established by the Engineer. **All work shall comply with the requirements of the City of Columbus ADA Rules and Regulations.** This work shall also consist of completing the Curb Ramp Compliance Checklist **by the designated ADA compliance officer** for each curb ramp installed. Provide Detectable Warnings conforming to [712.14](#). Place detectable warnings in accordance with [Standard Drawing 2319](#) and manufacturer's installation instructions.

- **Documentation of compliance is now required per CMS 608.07 (CMS Revision July 1, 2018)**
- **The contractor must identify an ADA compliance officer for the project**
- **The contractor must provide a signed compliance form for every ramp constructed.**
- **Construction Inspection must verify at least 10% of the compliance forms**

# Questions and Discussion?



## **Kathleen Harman, PE**

ADA Design Manager

614.724.0574

[keharman@columbus.gov](mailto:keharman@columbus.gov)

## **Chris Insley**

Design Staff

614.645.6094

[cbinsley@columbus.gov](mailto:cbinsley@columbus.gov)