

THE CITY OF
COLUMBUS
ANDREW J. GINTHER, MAYOR

DEPARTMENT OF
PUBLIC SERVICE

TRAFFIC SIGNAL DESIGN MANUAL

Effective Date: May 1, 2014
Revision: December 1, 2023

TABLE OF CONTENTS

1	GENERAL	
1.1	Purpose and Application of this Manual	1-1
1.2	References	1-2
1.3	Plan Approval	1-5
1.3.1	Capital Improvement Projects	1-5
1.3.2	Privately Funded Projects	1-5
1.3.3	Private Utility Projects	1-5
1.4	Utility Coordination	1-6
1.5	Traffic Signal Design Checklists	1-6
2	PLAN PREPARATION	
2.1	Drafting Standards	2-1
2.1.1	Traffic Signal Plan Symbols/Legend	2-3
2.2	Plan Sheets	2-6
2.2.1	Traffic Signal General Notes Sheet	2-6
2.2.2	Traffic Signal Estimate of Quantities	2-6
2.2.3	Traffic Signal Removal Plan Sheet	2-6
2.2.4	Traffic Signal Plan Sheet	2-6
2.2.5	Traffic Signal Detail Sheet	2-7
2.2.6	Traffic Signal Pole Fabrication and Orientation Data Sheet	2-7
2.2.7	Traffic Signal Interconnect Sheets	2-8
2.2.8	Maintenance of Traffic Temporary Signal Plans	2-8
2.2.9	Maintenance of Traffic Sheets (Head Shifts Only)	2-8
2.3	Estimate of Quantities	2-8
3	TEMPORARY TRAFFIC SIGNALS AND INTERCONNECT	
3.1	Temporary Traffic Signals	3-1
3.1.1	Basic Temporary Signal Modifications	3-1
3.1.2	Intermediate Temporary Signal Modifications	3-2
3.1.3	Detailed Temporary Signal Plans	3-3
3.2	Temporary Signal Supports	3-5
3.2.1	Span Wire Temporary Traffic Signals	3-5
3.3	Temporary Vehicle Detection	3-5
3.4	Temporary Vehicular Signal Heads	3-6
3.5	Temporary Pedestrian Features	3-6
3.6	Temporary Pavement Markings and Signs	3-6
3.7	Temporary Signal Wiring and Controller Cabinets	3-6
3.8	Temporary Interconnect Plan	3-7
3.8.1	Temporary Interconnect Plan Components	3-7
4	SUPPORTS AND FOUNDATIONS	
4.1	Traffic Signal Supports	4-1
4.1.1	Standard Mast Arm Supports	4-1
4.1.2	Decorative Mast Arm Supports	4-1

4.1.3 Double Mast Arm Supports	4-2
4.1.4 Strain Poles	4-2
4.1.4.1 Strain Pole Sizing	4-3
4.1.4.2 Span Configuration	4-3
4.1.5 Pedestal Supports	4-4
4.1.5.1 5 ft. Pedestal	4-4
4.1.5.2 10.7 ft. Pedestal	4-4
4.1.5.3 12.7 ft. Pedestal	4-5
4.1.5.4 17.5 ft. Pedestal	4-5
4.1.5.5 21 ft. Pedestal	4-5
4.1.6 Bracket Arms	4-5
4.1.7 Finish Requirements	4-5
4.1.7.1 Special Area Districts	4-5
4.2 Traffic Signal Support Foundations	4-6
4.2.1 Mast Arm and Strain Pole Foundations.....	4-6
4.2.2 Pedestal Foundations.....	4-6
4.3 Traffic Signal Support Placement.....	4-7
4.3.1 General Location.....	4-7
4.3.2 Clear Zone	4-7
4.3.3 Underground Utility Clearance	4-7
4.3.4 Overhead Utility Clearance	4-8
4.3.5 Pushbutton Location.....	4-11
4.3.6 Elevation	4-11
4.3.7 Arm Length/Span Configuration	4-12
4.3.8 Distance from Stop Line	4-12
4.4 Plan Requirements.....	4-12
4.4.1 Pole Identification.....	4-12
4.4.2 Pole Orientation and Fabrication Data	4-13
5 VEHICULAR SIGNALS	
5.1 Vehicular Signal Head Specifications	5-1
5.1.1 Material Specifications	5-1
5.1.2 Vehicular Signal Head Lens Size	5-1
5.1.3 Vehicular Signal Head Backplates	5-1
5.1.4 Signal Head Mounting.....	5-3
5.1.5 Signal Head Color	5-3
5.1.5.1 Special Signal Head Color	5-3
5.2 Vehicular Signal Head Application	5-3
5.2.1 Number of Signal Heads	5-3
5.2.2 Distance from Stop Line to Signal Head.....	5-4
5.2.3 Signal Head Mounting Height.....	5-4
5.2.4 Vehicular Signal Head Alignment.....	5-4
5.2.4.1 Vehicular Signal Head Alignment – Through Lanes	5-5
5.2.4.2 Vehicular Signal Head Alignment – Turn Lanes	5-5

6	PEDESTRIAN FEATURES	
6.1	Pedestrian Signal Heads	6-1
6.1.1	Material Specifications	6-1
6.1.2	Pedestrian Head Mounting	6-1
6.1.3	Pedestrian Head Alignment	6-2
6.1.4	Pedestrian Head Color	6-2
6.1.4.1	Special Pedestrian Head Color	6-2
6.2	Pedestrian Pushbuttons	6-3
6.2.1	Pushbutton Specifications	6-3
6.2.2	Pushbutton Location/Mounting	6-3
6.3	Accessible Pedestrian Signals	6-4
6.3.1	Accessible Pedestrian Signals Specifications	6-4
6.3.2	Installation Requirements	6-4
7	INTERSECTION WIRING	
7.1	Intersection Wiring	7-1
7.2	Material Specifications	7-1
7.3	Grounding and Bonding	7-1
7.3.1	Ground Rods	7-3
7.4	Number, Color, and Gauge of Conductors	7-4
7.4.1	Vehicular Signal Head Wiring	7-4
7.4.2	Pedestrian Signal Head Wiring	7-4
7.4.3	Pedestrian Pushbutton Wiring	7-5
7.4.4	Accessible Pedestrian Pushbutton Wiring	7-5
7.4.5	Illuminated Signs	7-5
7.4.6	Radar Detection	7-5
7.4.7	Inductive Loop Detection	7-5
7.4.8	Video Detection	7-5
7.4.9	Emergency Vehicle Preemption	7-6
7.4.10	Railroad Preemption	7-6
7.4.11	Transit Priority	7-6
7.5	Overhead Wiring	7-10
7.5.1	Messenger Wire	7-10
7.5.2	Span Configuration	7-11
7.6	Underground Wiring	7-11
7.6.1	Cable Routing	7-12
7.6.2	Conduit Fill	7-12
7.7	Combination Lighting	7-14
7.8	Overhead Clearances	7-14
7.9	Intersection Wiring Plan Components	7-15
8	TRAFFIC SIGNAL SIGNS	
8.1	General	8-1
8.2	Material Specifications	8-1
8.3	Sign Mounting	8-1

8.3.1	Strain Pole and Signal Support Mounted Signs	8-1
8.3.2	Mast Arm Mounted Signs	8-1
8.3.3	Span Wire Mounted.....	8-1
8.4	Signs for New or Modified Traffic Signals	8-2
8.4.1	New Signal Installation	8-2
8.4.2	Modified Signal Phasing Application	8-2
8.5	Left (Right) On Green Arrow Only (R10-5)	8-2
8.6	Right Turn Signal (R10-10R).....	8-3
8.7	No Left Turn (R3-2) / No Right Turn (R3-1).....	8-3
8.8	One Way (R6-2).....	8-3
8.9	Begin/End One Way (R6-6, R6-7)	8-4
8.10	No Turn on Red (R10-11b, R10-11c, CM-R10-11c).....	8-4
8.11	Stop Here on Red (R10-6).....	8-5
8.12	No Ped Crossing (R9-3) and Use Crosswalk (R9-3bP).....	8-5
8.13	Pedestrian Pushbutton Sign (R10-3a(R), R10-3a(L) and CMR10-3a)	8-5
8.14	Bicycle Signal Actuation (R10-22)	8-6
8.15	LED “Blank-out” Signs	8-6
8.16	Turning Traffic Yield To Pedestrians (R10-15).....	8-6
9	VEHICLE DETECTION	
9.1	Vehicle Detection	9-1
9.2	Vehicle Detection Types	9-1
9.2.1	Radar Detection	9-1
9.2.2	Video Detection	9-1
9.2.3	Inductive Loop Detection.....	9-2
9.3	Vehicle Detection Application.....	9-2
9.3.1	Radar Detector Mounting	9-2
9.3.1.1	Stop Line Detector.....	9-2
9.3.1.2	Dilemma Zone Detector	9-10
9.3.2	Video Detector Mounting.....	9-15
9.3.3	Inductive Loop Installation.....	9-15
9.3.4	Vehicle Detection Area.....	9-16
9.3.4.1	Presence Detection	9-16
9.3.4.2	Advanced and Dilemma Zone Detection	9-16
9.3.5	Vehicle Detection Delay Settings	9-17
9.3.6	Side Street Detection	9-18
9.3.7	Left Turn Detection.....	9-20
9.3.7.1	Major Street Protected Only Left Turn.....	9-20
9.3.7.2	Major Street Protected / Permissive Left-Turn.....	9-20
9.3.7.3	Major Street with no left turn phase.....	9-21
9.3.7.4	Side Street Protected Only Left Turn.....	9-21
9.3.7.5	Side Street Protected / Permissive Left-Turn	9-21
9.3.8	Advanced Detection	9-22
9.3.9	Dilemma Zone Detection.....	9-22
9.3.10	System Detection	9-24
9.3.11	Bicycle Detection.....	9-24

9.4	Detection Plan Components	9-25
9.4.1	Detection Identification Numbers	9-25
9.4.2	Detection Chart	9-26
10	POWER SERVICE	
10.1	Power Source	10-1
10.2	Overhead Power Service	10-2
10.3	Underground Power Service	10-2
10.4	Power Meter Cabinet Placement.....	10-3
10.5	Power Service – Plan Components	10-3
10.6	Voltage Drop.....	10-3
10.6.1	Voltage Drop Equations	10-4
11	CONTROLLER / CABINET	
11.1	Traffic Signal Controller / Cabinet	11-1
11.1.1	Traffic Signal Controllers	11-1
11.1.2	Traffic Signal Cabinets	11-1
11.1.2.1	Traffic Signal Cabinet Sizes	11-1
11.1.2.2	Traffic Signal Cabinet Placement	11-2
11.1.3	Cabinet Foundation	11-2
11.2	Uninterruptible Power Supply.....	11-3
11.2.1	UPS Cabinet Foundation.....	11-3
12	INTERCONNECT	
12.1	Traffic Signal Interconnect.....	12-1
12.2	Interconnect Plans	12-1
12.3	Advance Notification	12-2
12.4	Fiber Optic Network Design	12-2
12.4.1	Cable.....	12-2
12.4.2	Slack Storage	12-2
12.4.3	Splicing.....	12-3
12.4.4	Connecting to Devices	12-4
12.4.5	Redundancy	12-6
12.5	Communication Nodes	12-9
12.6	Wireless Ethernet System Design	12-18
12.7	Underground Cable Installation.....	12-19
12.8	Overhead Cable Installation	12-19
12.8.1	New Attachments	12-19
12.8.2	Existing Attachments.....	12-20
12.8.3	Remove and Replace Existing Overhead Interconnect.....	12-20
12.9	Relocation and Reuse of Existing CTSS Fiber Optic Interconnect Cable ...	12-20

13 UNDERGROUND FACILITIES	
13.1 Underground Facilities	13-1
13.2 Conduit General	13-1
13.2.1 Conduit Types/Sizes	13-1
13.2.2 Conduit Capacity	13-2
13.2.3 Conduit Clearance from Adjacent Utilities	13-2
13.2.4 Conduit Alignment	13-3
13.3 Conduit Installation	13-4
13.3.1 Trench	13-4
13.3.2 Encasement	13-7
13.3.3 Drilled or Directionally Bored	13-7
13.4 Conduit Application	13-8
13.4.1 Traffic Signal Conduit	13-8
13.4.2 Traffic Signal Power Conduit	13-8
13.4.3 Interconnect Conduit	13-9
13.4.4 Bridge Conduit	13-10
13.5 Conduit Risers	13-11
13.5.1 Traffic Signal Conduit Riser Applications	13-11
13.5.1.1 Existing Wood Pole	13-11
13.5.1.2 Existing Anchor Base Pole	13-11
13.5.1.3 Existing Embedded Pole with Pole Mounted Cabinet	13-11
13.5.1.4 Existing Embedded Pole with Ground Mounted Cabinet	13-12
13.5.2 Interconnect Conduit Risers	13-12
13.5.3 Power Service Conduit Risers	13-12
13.6 Pull Boxes	13-12
13.6.1 Pull Box Locations	13-12
13.6.2 Pull Box Clearance	13-14
13.7 Pull Box Application	13-14
13.7.1 Loop Detector Pull Boxes (12 in. x 18 in.) and (13 in. x 24 in.)	13-14
13.7.2 Pull Box (27 in.)	13-14
13.7.3 Pull Boxes (32 in.)	13-15
13.7.4 Pull Boxes (48 in.)	13-15
13.7.5 Traffic Signal Power Pull Box	13-16
13.8 Underground Facilities Plan Components	13-16
13.8.1 Conduit	13-16
13.8.2 Pull Boxes	13-18
14 REMOVAL AND REUSE OF TRAFFIC SIGNAL INSTALLATIONS	
14.1 Removal of Existing Traffic Signal	14-1
14.1.1 Temporary Removal	14-1
14.1.2 Removal for Replacement	14-1
14.2 Removal of Existing Traffic Signal – Plan Components	14-2
14.3 Reuse of Traffic Signal Equipment	14-2

15	TIMING / PHASING	
	15.1 Traffic Signal Timing	15-1
	15.1.1 Yellow Change Interval	15-1
	15.1.2 Red Clearance Interval	15-1
	15.1.3 Pedestrian Walk Time	15-1
	15.1.4 Pedestrian Clearance Interval	15-1
	15.1.5 Pedestrian Change Interval (Flashing DON'T WALK)	15-2
	15.1.6 Minimum Initial Green Time	15-7
	15.1.7 Maximum Green Time	15-7
	15.1.8 Passage and Extension Time	15-7
	15.1.8.1 Posted Speed 35 MPH or Less	15-7
	15.1.8.2 Posted Speed 40 MPH or Greater	15-8
	15.2 Traffic Signal Phasing	15-10
	15.2.1 Phasing Directions	15-10
	15.2.2 Vehicle and Pedestrian Recall and Memory	15-10
	15.2.3 Left-turn Phasing	15-10
	15.2.4 Split Phasing	15-12
	15.2.5 Yellow Trap	15-12
	15.2.6 Lead/Lag Phasing	15-13
	15.2.7 Overlap Phasing	15-14
	15.3 Plan Components	15-14
	15.3.1 Phasing Diagram	15-14
	15.3.2 Field Wiring Hook-up Chart	15-14
	15.3.3 Timing Chart	15-14
16	PEDESTRIAN HYBRID BEACONS (PHBs)	
	16.1 General	16-1
	16.2 PHB Support Placement	16-1
	16.3 Pedestrian Pushbuttons	16-1
	16.4 Sight Distance	16-1
	16.5 Signing	16-2
	16.6 Pavement Markings	16-3
	16.7 Signal Phase Assignments	16-3
	16.8 Sequencing and Timing	16-6
	16.9 Supports and Foundations	16-8
	16.10 Vehicular Signal Heads	16-9
	16.11 Wiring	16-11
	16.12 Controller and Power Meter Cabinets	16-12
	16.13 Interconnect	16-12
17	SPECIAL CONDITIONS	
	17.1 Emergency Vehicle Preemption	17-1
	17.2 Railroad Preemption	17-1
	17.3 Transit Priority	17-1
	17.4 Leading Pedestrian Interval (LPI)	17-1
	17.4.1 Criteria	17-2

17.4.2 Implementation.....	17-3
17.4.3 Additional Considerations.....	17-4
17.5 General Flashing Operation	17-4
17.5.1 New Signal Flashing Operations	17-5
17.5.2 Programmed (Night) Flashing Operations.....	17-5
17.5.3 School Signal Flashing Operations	17-6
17.6 Non DPS Pole Attachment Process.....	17-7
17.7 Proposed Signal with Unresolved Warrant Status.....	17-10

FIGURES

2.1	Traffic Signal Symbols and Legend.....	2-3
2.2	Traffic Signal Wiring Diagram Legend.....	2-5
2.3	Grounding and Bonding Diagram Legend.....	2-5
4.1	Overhead Utility Clearance Illustration (Profile View).....	4-10
4.2	Overhead Utility Clearance Illustration (Strain Pole Cross-section View)...	4-10
4.3	Overhead Utility Clearance Illustration (Mast Arm Cross-section View).....	4-11
4.4	Typical Mast Arm Fabrication and Orientation Data.....	4-14
4.5	Typical Mast Arm Fabrication and Orientation Data Chart (Radar Detection).....	4-15
4.6	Typical Mast Arm Fabrication and Orientation Data Chart (Video Detection).....	4-16
4.7	Typical Strain Pole Fabrication and Orientation Data.....	4-17
4.8	Typical Strain Pole Fabrication and Orientation Data Chart.....	4-18
5.1	Vehicular Traffic Signal Head Configuration	5-2
5.2	Vehicular Signal Head Alignment – Single Approach Lane, Configuration A.....	5-7
5.3	Vehicular Signal Head Alignment – Two Approach Lanes, Configuration A.....	5-8
5.4	Vehicular Signal Head Alignment – Two Approach Lanes, Configuration B.....	5-9
5.5	Vehicular Signal Head Alignment – Two Approach Lanes, Configuration C.....	5-10
5.6	Vehicular Signal Head Alignment – Two Approach Lanes, Configuration D.....	5-11
5.7	Vehicular Signal Head Alignment – Two Approach Lanes, Configuration E.....	5-12
5.8	Vehicular Signal Head Alignment – Two Approach Lanes, Configuration F.....	5-13
5.9	Vehicular Signal Head Alignment – Two Approach Lanes, Configuration G.....	5-14
5.10	Vehicular Signal Head Alignment – Two Approach Lanes, Configuration H.....	5-15
5.11	Vehicular Signal Head Alignment – Three Approach Lanes, Configuration A.....	5-16
5.12	Vehicular Signal Head Alignment – Three Approach Lanes, Configuration B.....	5-17
5.13	Vehicular Signal Head Alignment – Three Approach Lanes, Configuration C.....	5-18
5.14	Vehicular Signal Head Alignment – Three Approach Lanes, Configuration D.....	5-19
5.15	Vehicular Signal Head Alignment – Three Approach Lanes, Configuration E.....	5-20
5.16	Vehicular Signal Head Alignment – Three Approach Lanes, Configuration F.....	5-21
5.17	Vehicular Signal Head Alignment – Three Approach Lanes, Configuration G.....	5-22
5.18	Vehicular Signal Head Alignment – Three Approach Lanes, Configuration H.....	5-23
5.19	Vehicular Signal Head Alignment – Three Approach Lanes, Configuration I.....	5-24
5.20	Vehicular Signal Head Alignment – Four Approach Lanes, Configuration A.....	5-25
5.21	Vehicular Signal Head Alignment – Four Approach Lanes, Configuration B.....	5-26
5.22	Vehicular Signal Head Alignment – Four Approach Lanes, Configuration C.....	5-27
5.23	Vehicular Signal Head Alignment – Four Approach Lanes, Configuration D.....	5-28
5.24	Vehicular Signal Head Alignment – Four Approach Lanes, Configuration E (1 of 2).....	5-29
5.25	Vehicular Signal Head Alignment – Four Approach Lanes, Configuration E (2 of 2).....	5-30
5.26	Vehicular Signal Head Alignment – Four Approach Lanes, Configuration F.....	5-31
5.27	Vehicular Signal Head Alignment – Five Approach Lanes, Configuration A.....	5-32
5.28	Vehicular Signal Head Alignment – Five Approach Lanes, Configuration B.....	5-33
5.29	Vehicular Signal Head Alignment – Five Approach Lanes, Configuration C (1 of 2).....	5-34
5.30	Vehicular Signal Head Alignment – Five Approach Lanes, Configuration C (2 of 2).....	5-35
5.31	Vehicular Signal Head Alignment – Five Approach Lanes, Configuration D.....	5-36

5.32	Vehicular Signal Head Alignment – Offset Left Turn Lane, Configuration A	5-37
5.33	Vehicular Signal Head Alignment – Offset Left Turn Lane, Configuration B	5-38
5.34	Vehicular Signal Head Alignment - Offset Left Turn Lane, Configuration C Exclusive Right Turn Lane...	5-39
5.35	Vehicular Signal Head Alignment Presence of Bike Lane (1 of 2)	5-40
5.36	Vehicular Signal Head Alignment Presence of Bike Lane (2 of 2)	5-41
6.1	Pedestrian Signal Head	6-1
6.2	Pedestrian Signal Head Alignment.....	6-2
6.3	Pushbutton Signs (R10-3a(R)), (R10-3a(L)), (CM-R10-3a).....	6-3
6.4	Audible Pushbutton Sign (CM-R73C.03).....	6-4
7.1	Grounding and Bonding Wiring Illustration – Mast Arm Example.....	7-2
7.2	Grounding and Bonding Wiring Illustration – Span Wire Example	7-3
7.3	Typical Vehicular Signal Head Wiring Per Approach	7-7
7.4	Typical Pedestrian Signal Head Wiring	7-8
7.5	Cable Grouping in Conduit.....	7-12
7.6	Intersection Wiring Diagram With Loop Detectors.....	7-16
7.7	Intersection Wiring Diagram With Radar Detection and Combination Lighting.....	7-17
8.1	Signs, As Per Plan (W3-3-36), (W16-15P-24).....	8-2
8.2	Signs, As Per Plan (W23-H2b-30).....	8-2
8.3	Left/Right On Green Arrow Only (R10-5L, R10-5R)	8-2
8.4	Right Turn Signal (R10-10R).....	8-3
8.5	No Left/Right Turns (R3-2), (R3-1).....	8-3
8.6	One Way (R6-2L), (R6-2R)	8-3
8.7	Begin/End One Way (R6-6), (R6-7)	8-4
8.8	No Turn on Red (R10-11b), (R10-11c), (CM-R10-11c)	8-4
8.9	Stop Here On Red (R10-6).....	8-5
8.10	No Ped Crossing Signs (R9-3), (R9-3bP).....	8-5
8.11	Bicycle Actuation (R10-22).....	8-6
8.12	Turning Vehicles Yield To Pedestrians (R10-15)	8-6
9.1	Stop Line Detector Placement - Preferred Location	9-4
9.2	Stop Line Detector Placement - Alternate Location 1	9-5
9.3	Stop Line Detector Placement - Alternate Location 2.....	9-6
9.4	Stop Line Detector Placement - Example Mast Arm Intersection Layout.....	9-7
9.5	Stop Line Detector Placement - Example Strain Pole Intersection Layout...	9-8
9.6	Stop Line Detector Placement - Strain Pole Installation - Multi-Lane Approach	9-9
9.7	Stop Line and Dilemma Zone Detector Placement - Example Intersection Layout.	9-10
9.8	Dilemma Zone Detector Placement - Preferred Mounting Location	9-12
9.9	Dilemma Zone Detector Placement - Alternate Mounting Location - Mast Arm.....	9-13
9.10	Dilemma Zone Detector Placement - Alternate Mounting Location - Bracket Arm.	9-14
9.11	Side Street Detection – Case A.....	9-19
9.12	Side Street Detection – Case B.....	9-19
9.13	Side Street Detection – Case C	9-20
9.14	Side Street Left Turn Detection For Protected / Permissive Left-Turn	9-21

9.15 Major Street Left Turn Detection For Protected / Permissive Left-Turn.....	9-22
9.16 Advanced / Dilemma Zone Detection.....	9-24
12.1 Fiber Patch Cable Jacket/Connector Color	12-5
12.2 Fiber Optic Redundancy Communications Paths	12-7
12.3 Fiber Optic Redundancy Scenarios	12-8
12.4 Typical Splicing Diagram – 2 Cables.....	12-11
12.5 Typical Splicing Diagram – 3 Cables.....	12-12
12.6 Typical Splicing Diagram – 4 Cables.....	12-13
12.7 Splicing Orientation – 2 Cables – East/West.....	12-14
12.8 Splicing Orientation – 2 Cables – North/South	12-15
12.9 Splicing Orientation – 3 Cables	12-16
12.10 Splicing Orientation – 4 Cables	12-17
12.11 4.9GHz Frequencies Available for Signal Interconnect Communication.....	12-18
13.1 Minimum Conduit Depth Under Pavement.....	13-8
15.1 Pedestrian Intervals	15-3
15.2 Pedestrian Clearance and Walk Interval Example #1.....	15-4
15.3 Pedestrian Clearance and Walk Interval Example #2	15-5
15.4 Pedestrian Clearance and Walk Interval Example #3	15-6
15.5 Dilemma Zone Example #1	15-9
15.6 2 Phase Example East-West Mainline	15-15
15.7 2 Phase Example North-South Mainline	15-16
15.8 8 Phase with RT Overlap Example East-West Mainline.....	15-17
15.9 Split Phase Example East-West Mainline Split Phase Side Street.....	15-18
15.10 8 Phase with RT Overlap Example North-South Mainline	15-19
15.11 Split Phase Example North-South Mainline Split Phase Side Street	15-20
15.12 N-S Lead-Lag Phasing Example 1 North-South Mainline.....	15-21
15.13 E-W Lead-Lag Phasing Example 2 North-South Mainline.....	15-22
15.14 Lead-Lag Phasing Example 3 North-South Mainline.....	15-23
16.1 PHB Signs.....	16-2
16.2 PHB Phasing and Field Wiring Hook-up Chart Example, East-West Mainline.....	16-4
16.3 PHB Phasing and Field Wiring Hook-up Chart Example, North-South Mainline...	16-5
16.4 Sequence for a Pedestrian Hybrid Beacon	16-6
16.5 PHB Head Alignment, Mid-Block Crossing, Two Approach Lanes... ..	16-9
16.6 PHB Head Alignment, Intersection Crossing, Four Approach Lanes.....	16-10
16.7 Pedestrian Hybrid Beacon Wiring Diagram Example	16-11
17.1 Sample Pole Attachment Agreement Work Sheet (AEP)	17-8
17.2 Sample Pole Attachment Agreement Work Sheet (COC)	17-9
17.3 Indicating Warrant Status in Quantities	17-10

TABLES

2.1	CAD Layer Naming	2-1
3.1	Summary of Temporary Signal Plan Tier Requirements	3-4
4.1	Overhead Utility Clearances.....	4-9
5.1	Vehicular Signal Head Location Guidelines	5-5
7.1	Minimum Number of Conductors.....	7-9
7.2	Pedestrian Signal Head – Field Wiring Color Codes.....	7-9
7.3	Vehicular Signal Head – Field Wiring Color Codes	7-10
7.4	Traffic Signal Cable Sizes	7-13
7.5	Overhead Wires, Cables and Equipment Clearances	7-15
9.1	Presence Detection Width.....	9-16
9.2	Advanced Detection Size	9-17
9.3	Recommended Detector Delay Settings	9-18
9.4	Advanced/Dilemma Zone Detector Locations	9-23
9.5	Detection Chart – Example #1 (Radar Detection)	9-26
9.6	Detection Chart – Example #2 (Video Detection).....	9-27
9.7	Detection Chart – Example #3 (Inductive Loop Detectors)	9-27
9.8	Detection Chart – Example #4 (Inductive Loop Detectors and Video Detection)	9-28
9.9	Detection Chart – Example #5 (Inductive Loop Detectors in a Closed Loop System).....	9-28
12.1	Typical Approximate Splice Enclosure Size	12-4
13.1	Conduit Dimensions	13-2
13.2	Minimum Conduit Clearance	13-3
13.3	Minimum Trench Depth.....	13-4
13.4	Pay Items for Signal and Interconnect Trench	13-6
13.5	Minimum Number of Conduits.....	13-10
13.6	Pull Box Dimensions	13-18
14.1	Example Traffic Signal Removal Chart	14-2
15.1	8 Phase Timing Chart Major Street E-W, Minor Street N-S	15-24
15.2	8 Phase Timing Chart Major Street N-S, Minor Street E-W.....	15-25
16.1	PHB Timing Chart Example	16-8

CHAPTER 1: GENERAL

1.1 Purpose and Application of this Manual

The City of Columbus Traffic Signal Design Manual (hereinafter the “Manual”) has been developed to promote uniformity in the application of traffic engineering practices, policies, and guidelines with respect to traffic signal design and signal system coordination in the City of Columbus. It is intended to clarify City expectations and expedite the production and review of design plans as well as the construction and operation of traffic signals. The intent of this Manual is to provide standards and best practices to the designer. It is not intended to supersede requirements of law nor application of sound principles by a knowledgeable design professional.

The Engineer in responsible charge for applying the concepts and practices assembled in this Manual is required to hold current registration as a Professional Engineer in the State of Ohio. The Engineer must also be prequalified by the Ohio Department of Transportation (ODOT) for Traffic Signal and/or Signal System design as applicable to the specific design effort.

While this Manual compiles guidelines, practices and requirements from a variety of sources, it is not warranted or represented to be comprehensive or sufficient in every respect. Engineering knowledge, experience and judgment must always be used to determine whether, and how, to apply the information included herein to specific situations.

Newer, or different, design techniques presented herein do not imply that existing signal designs are unsafe, nor does it mandate the initiation of improvement projects. Rehabilitation projects often enable the maintaining agency to improve safety by selectively upgrading existing intersection features without the cost of full reconstruction. Accordingly, the extent to which this Manual is applied to maintenance and rehabilitation projects may vary depending on the scope of the improvement and site specific investigations, history and analysis.

Criteria guiding the decision to install or maintain a traffic signal in lieu of other types of traffic control devices are beyond the scope of this Manual and are not addressed herein. The reader is directed to the Ohio Manual of Uniform Traffic Devices (OMUTCD) and other City guidelines governing the selection of traffic controls.

1.2 References

Several references to other publications are provided throughout this document. These references and associated links are current at the time of publication. The City of Columbus does not monitor the external resources and the designer is responsible to consult the source for updates and or modifications. The most current version should be used.

City of Columbus Construction and Material Specifications

* <http://www.columbus.gov/Templates/Detail.aspx?id=65097>

Ohio Manual of Uniform Traffic Control Devices

<https://www.dot.state.oh.us/roadway/omutcd/Pages/default.aspx>

City of Columbus Traffic Qualified Products List

* <https://www.columbus.gov/WorkArea/DownloadAsset.aspx?id=2147509158>

City of Columbus Standard Construction Drawings

* <http://www.columbus.gov/Templates/Detail.aspx?id=65098s>

National Electrical Code

<http://www.nfpa.org/codes-and-standards/all-codes-and-standards/list-of-codes-and-standards/detail?code=70>

National Electrical Safety Code

<http://standards.ieee.org/>

IMSA Official Wire & Cable Specification Manual

<http://www.imsasafety.org/>

Ohio Department of Transportation's Traffic Engineering Manual

<http://www.dot.state.oh.us/Divisions/Engineering/Roadway/DesignStandards/traffic/TEM/Pages/default.aspx>

Ohio Department of Transportation's Location and Design Manual

<http://www.dot.state.oh.us/Divisions/Engineering/Roadway/DesignStandards/roadway/Pages/locationanddesignmanuals.aspx>

SWISS Span Wire Software

<http://www.dot.state.oh.us/Divisions/Engineering/Roadway/TrafficControl/Pages/swiss.aspx>

* The City of Columbus website will be updated in 2023. Links subject to change.

Occupational Safety and Health Administration

<http://www.osha.gov/>

Highway Capacity Manual (HCM)

<http://www.trb.org/Main/Blurbs/175169.aspx>

City of Columbus ADA Rules and Regulations

* <https://www.columbus.gov/WorkArea/DownloadAsset.aspx?id=2147503533>

City of Columbus DPS Design Memos

* <https://www.columbus.gov/Templates/Detail.aspx?id=2147517964>

City of Columbus, Computer Aided Drafting (CAD) Standards For Creation And Submittal Of Digital Drawings

* <http://www.columbus.gov/Templates/Detail.aspx?id=44288>

City of Columbus E-Plan requirements

* <https://www.columbus.gov/WorkArea/DownloadAsset.aspx?id=2147510654>

City of Columbus Traffic Signal General Notes

* <https://www.columbus.gov/Templates/Detail.aspx?id=2147515832>

Columbus Development Guide

* <https://www.columbus.gov/bzs/primary/Building-and-Zoning-Services-Document-Library/>

City of Columbus Sample Plan Sheets

* <http://www.columbus.gov/Templates/Detail.aspx?id=65103>

Ohio Utilities Protection service

<http://www.oups.org/>

Design Guidelines for Water Distribution System Capital Improvement Projects

* <https://www.columbus.gov/WorkArea/DownloadAsset.aspx?id=57429>

City of Columbus Street Lighting Specifications (MIS Drawings)

* <https://www.columbus.gov/Templates/Detail.aspx?id=2147503308>

Ohio Revised Code

<http://codes.ohio.gov/orc/4511>

Right-of-Way (ROW) Plan Routing Manual

* <https://www.columbus.gov/publicservice/Design-and-Construction/Document-Library/>

* The City of Columbus website will be updated in 2023. Links subject to change.

Ohio Department of Transportation's Standard Construction Drawing

<http://www.dot.state.oh.us/Divisions/Engineering/Roadway/DesignStandards/traffic/SCD/Pages/default.aspx>

City of Columbus Utility Manual

*<https://www.columbus.gov/publicservice/Design-and-Construction/document-library/CIP-Utility-Coordination---Private-Utilities/>

American National Standards Institute

<http://www.ansi.org/>

* The City of Columbus website will be updated in 2023. Links subject to change.

1.3 Plan Approval

Plan routing and approval is subject to the specific application and can generally be categorized into one of the following three classifications: capital improvement projects, privately funded projects, and private utility projects.

1.3.1 Capital Improvement Projects

For Capital Improvement Projects (CIP) and projects managed by a City of Columbus Department or Division (usually the Department of Public Service) the plan submittal and approval process shall be coordinated directly with the assigned project manager/coordinator.

Projects managed by the City of Columbus Department of Public Service shall conform to City of Columbus [E-Plan \(XXXX-E\)](#) requirements. Projects funded and managed by the Department of Public Utilities may be subject to varying plan format requirements. In all cases the plan approval process shall be coordinated with the City of Columbus project manager/ coordinator.

1.3.2 Privately Funded Projects

For privately funded projects the design, review and approval process is also subject to the requirements outlined by the [City of Columbus Department of Building and Zoning Services](#) in the [Columbus Development Guide](#).

1.3.3 Private Utility Projects

Private utility projects that impact traffic signals are subject to the design, review and approval process outlined in the City of Columbus [Right-of-Way \(ROW\) Plan Routing Manual](#).

The number of City of Columbus Departments that will review the plan is based on the plan content, the proximity to adjacent facilities and potential for conflicts. Traffic signal improvements are normally subject to concurrent review and approval from some or all of the following City Departments/Divisions.

Department of Public Service:

Division of Design and Construction

Department of Public Utilities:

Division of Water

Division of Sewerage and Drainage

Division of Power

Department of Recreation and Parks
Department of Technology
Fire Prevention Bureau, Division of Fire

Other Departments/Divisions may have review authority depending on the scope of the improvement.

When traffic signals are located adjacent to or partially within an adjacent jurisdiction(s) approval from these jurisdiction(s) may be required.

1.4 Utility Coordination

As outlined in the [City of Columbus Utility Manual](#), the location of all underground and overhead utilities as well as ownership shall be identified and clearly shown on the plan. The referenced Utility Manual outlines the responsibility of the design Consultant and coordination requirements. A sample coordination log and utility company contact list is provided with the Utility Manual.

1.5 Traffic Signal Design Checklists

Checklists provided herein apply to all projects affecting signalized intersections. These checklists were developed to correspond to a staged submittal process (Stage 1, Stage 2, and Stage 3).

Post Stage 1 Field Meeting

Following the Stage 1 review, the Design Consultant and the City of Columbus may elect to conduct an onsite traffic signal field review meeting. The purpose of the meeting is to go over the Stage 1 design and compare the Stage 1 plans to the existing field conditions. The meeting will also serve as an opportunity to correct items incorrectly shown in or missing from the existing conditions base map.

The City of Columbus, Department of Public Service is a member of OUPS. Prior to the Post Stage 1 field meeting, existing underground utilities should be marked through the Ohio Utilities Protection Service (OUPS).

Stage 1 - Submittal Checklist

All items listed below shall be included on the traffic signal plan for a Stage 1 submittal.

Existing infrastructure (minimum items to show):

- Underground and overhead utilities with disposition labeled on plan and profile
- Right-of-way and corporation lines
- Edge of pavement, curb, walk, etc.
- Curb ramp locations
- Pavement markings
- Traffic signal poles and pedestals
- Messenger wire and vehicular signal heads
- Overhead and pole mounted signs
- Traffic signal cabinet
 - If an existing pole mounted cabinet is to be used, check for overhang violations.
- Traffic pull boxes
 - An existing pull box that will be incorporated in the proposed concrete walk shall be checked to ascertain if it is rated for concrete installation.
- Pushbuttons and pedestrian signal heads
 - Show each existing pushbutton and each existing pedestrian signal head. Orientate these items correctly on the plans. Check the pushbuttons for proper ADA height and type requirements. Record the height above the ADA pathway and type. Determine if each pushbutton meets current ADA requirements. Mounting heights greater than the City's ADA requirements shall result in the relocation of the pushbutton to the current standard mounting height. Non-ADA type pushbutton shall be replaced with an approved Department ADA pushbutton.
- Traffic conduit
- Loop detector
 - Show each loop, its lead-in, and its associated pull box, if any, on all side streets and the main street that are or may be affected by the project. Ascertain whether the loop detector lead-in cable is in a raceway or direct buried. Any direct buried lead-in cable that will be under proposed sidewalk shall be replaced with new cable in conduit. Loops shall be shown to scale. Relocate any existing pull box that lies in a curb ramp, its landing area or its flare area. This may require pull box replacement and a redesign of the loop underground. If loops are not visible in the field, contact the City of Columbus for record plan information.

Proposed infrastructure including:

- Underground and overhead utilities
- Right-of-way and corporation lines
- Edge of pavement, curb, walk, etc.
- Curb ramp locations
- Pavement markings
- Traffic signal poles and pedestals
- Pull boxes
- Signal and interconnect conduit routings
- Controller location and orientation
 - Show the proposed pole mounted control cabinet if relocated or the proposed base mounted cabinet and all required installation diagrams and typicals .
- Vehicular signal head locations and configurations
- Signal head configuration legend
- Traffic Signal Legend
- Span configuration

Stage 2 - Submittal Checklist

In addition to all of the items outlined in the Stage 1 checklist, items listed below shall be included on the signal plan for a Stage 2 submittal.

- Traffic signal power source
Identify the proposed power supplier and source location. If feasible, provide written documentation from the power company.
- Estimate of Quantities (item descriptions only)
- Traffic signal and interconnect general notes and “As Per Plan” or “Misc.” notes
- Plan sheet notes
- Proposed ADA compliant pushbutton and pedestrian signal head locations and orientation
- Detection zones and/or loop locations
- Detailed signal and interconnect conduit and wiring callout information
- Field wiring hookup chart
- Wiring diagram
- Grounding and bonding diagram and legend
- Phasing diagram
- Detection chart
- Detail sheet notes
- Signal support and overhead mounted signs
- Traffic signal interconnect splicing details and devices
- Conduit bank details/typical sections for encased interconnect
- Special details
- Traffic signal removal chart
- Temporary signal and/or temporary signal modifications
- Temporary traffic signal (maintenance of traffic) notes
- Temporary interconnect plans, details, and associated notes
- Disposition to Stage 1 review comments

Stage 3 - Submittal Checklist

In addition to the items outlined in the Stage 1 and 2 checklists, items listed below shall be included on the signal plan for a Stage 3 submittal.

- Timing chart
- Signal pole fabrication and orientation data chart
- Typical pole orientation and elevation details
- Span diagram (span wire signals)
- SWISS calculations for span wire traffic signals
- Completed estimate of quantities
- Joint use pole attachment agreement and associated permits
- Traffic signal standard drawing references on the title sheet
- Disposition to Stage 2 review comments

Back check - Submittal Checklist

All items outlined in the Stage 1, 2, and 3 checklists shall be included on the signal plan for all back check submittals.

Final Plans - Submittal Checklist

All items outlined in the Stage 1, 2, and 3 checklists shall be included on the signal plan for the Final Plans submittal.

CHAPTER 2: PLAN PREPARATION

2.1 Drafting Standards

The digital drawing guidelines described herein are furnished to provide a technical guide for the creation of digital information as defined in the [Columbus Development Guide](#). The purpose of these standards is to create consistency in the format of digital CAD drawings and images submitted to the City of Columbus.

Drawing files should be developed using AutoCAD consistent with the requirements outlined in the [Computer Aided Drafting \(CAD\) Standards For Creation And Submittal Of Digital Drawings](#) as published by the City of Columbus.

While the above referenced document outlines layer names for traffic signal plan elements, the list outlined in **Table 2.1 Cad Layer Naming** should be used.

Table 2.1
CAD Layer Naming

Layer Description	Name of Layer	Line weight
Signal Poles - Existing	COC-SGNL-POLE-E	50%
Signal Poles - Proposed	COC-SGNL-POLE-N	70%
Signal Poles - Down Guys - Existing	COC-SGNL-POLE-GUYS-E	50%
Signal Poles - Down Guys - Proposed	COC-SGNL-POLE-GUYS-N	70%
Signal Heads - Existing	COC-SGNL-HEAD-E	50%
Signal Heads - Proposed	COC-SGNL-HEAD-N	70%
Conduit - Existing	COC-SGNL-COND-E	50%
Conduit - Proposed	COC-SGNL-COND-N	100%
Pull boxes - Existing	COC-SGNL-PULL-E	50%
Pull boxes - Proposed	COC-SGNL-PULL-N	70%
Detectors (loop)- Existing	COC-SGNL-DECT-LOOP-E	50%
Detectors (loop)- Proposed	COC-SGNL-DECT-LOOP-N	70%
Detectors (video) - Existing	COC-SGNL-DECT-VDEO-E	50%
Detectors (video) - Proposed	COC-SGNL-DECT-VDEO-N	70%
Detectors (microwave) - Existing	COC-SGNL-DECT-MICR-E	50%
Detectors (microwave) - Proposed	COC-SGNL-DECT-MICR-N	70%
Detectors (RADAR) - Existing	COC-SGNL-DECT-RADR-E	50%
Detectors (RADAR) - Proposed	COC-SGNL-DECT-RADR-N	70%
Pavement markings -Existing	COC-SGNL-MRKG-(TYPE)-E	50%
Pavement markings -Proposed	COC-SGNL-MRKG-(TYPE)-N	70%

Table 2.1 (cont.)
CAD Layer Names

Layer Description	Name of Layer	Line weight
Signal Controller Cabinet / Pad Mount - Existing	COC-SGNL-CONT-BASE-E	50%
Signal Controller Cabinet/ Pad Mount - Proposed	COC-SGNL-CONT-BASE-N	70%
Signal Controller Cabinet / Pole Mount - Existing	COC-SGNL-CONT-POLE-E	50%
Signal Controller Cabinet/ Pole Mount - Proposed	COC-SGNL-CONT-POLE-N	70%
Overhead Wire - Existing	COC-SGNL-OVHD-E	50%
Overhead Wire - Proposed	COC-SGNL-OVHD-N	70%
Mast Arm - Existing	COC-SGNL-MAST-E	50%
Mast Arm - Proposed	COC-SGNL-MAST-N	70%
Signal Text - Existing	COC-SGNL-TEXT-E	50%
Signal Text - Proposed	COC-SGNL-TEXT-N	70%
Signal Details - Medium	COC-SGNL-DETL-MEDM	70%
Signal Details - Header	COC-SGNL-DETL-HEDR	100%
Signal Dimensions - Existing	COC-SGNL-DIMS-E	50%
Signal Dimensions - Proposed	COC-SGNL-DIMS-E	70%
Interconnect Cabinet / Pad Mount - Existing	COC-INTCOC-CONT-BASE-E	50%
Interconnect Cabinet/ Pad Mount - Proposed	COC-INTCOC-CONT-BASE-N	70%
Interconnect Cabinet / Pole Mount - Existing	COC-INTCOC-CONT-POLE-E	50%
Interconnect Cabinet/ Pole Mount - Proposed	COC-INTCOC-CONT-POLE-N	70%
Signs - Ground Mount - Existing	COC-SGNL-SIGN-GRND-E	50%
Signs - Ground Mount - Proposed	COC-SGNL-SIGN-GRND-N	70%
Signs - Pole Mount - Existing	COC-SGNL-SIGN-POLE-E	50%
Signs - Pole Mount - Proposed	COC-SGNL-SIGN-POLE-N	70%
Signs - Overhead Mount - Existing	COC-SGNL-SIGN-OVHD-E	50%
Signs - Overhead Mount - Proposed	COC-SGNL-SIGN-OVHD-N	70%
Sign Text - Existing	COC-SGNL-SIGN-TEXT-E	50%
Sign Text - Proposed	COC-SGNL-SIGN-TEXT-N	70%
Sign Details	COC-SGNL-SIGN-DETL-N	70%

Layer Identifier

E =	EXISTING
N =	NEW/PROPOSED
F =	FUTURE
T =	TEMPORARY
D =	DEMOLISHED/REMOVED

Pavement Marking Type (TYPE)

Edge Line - White
Edge Line - Yellow
Center Line - Double Yellow
Center Line - Solid Dash
Lane Line
Stop Line
Channelizing Line
Arrow
Word

2.1.1 Traffic Signal Plan Symbols/Legend

Figure 2.1
Traffic Signal Symbols and Legend

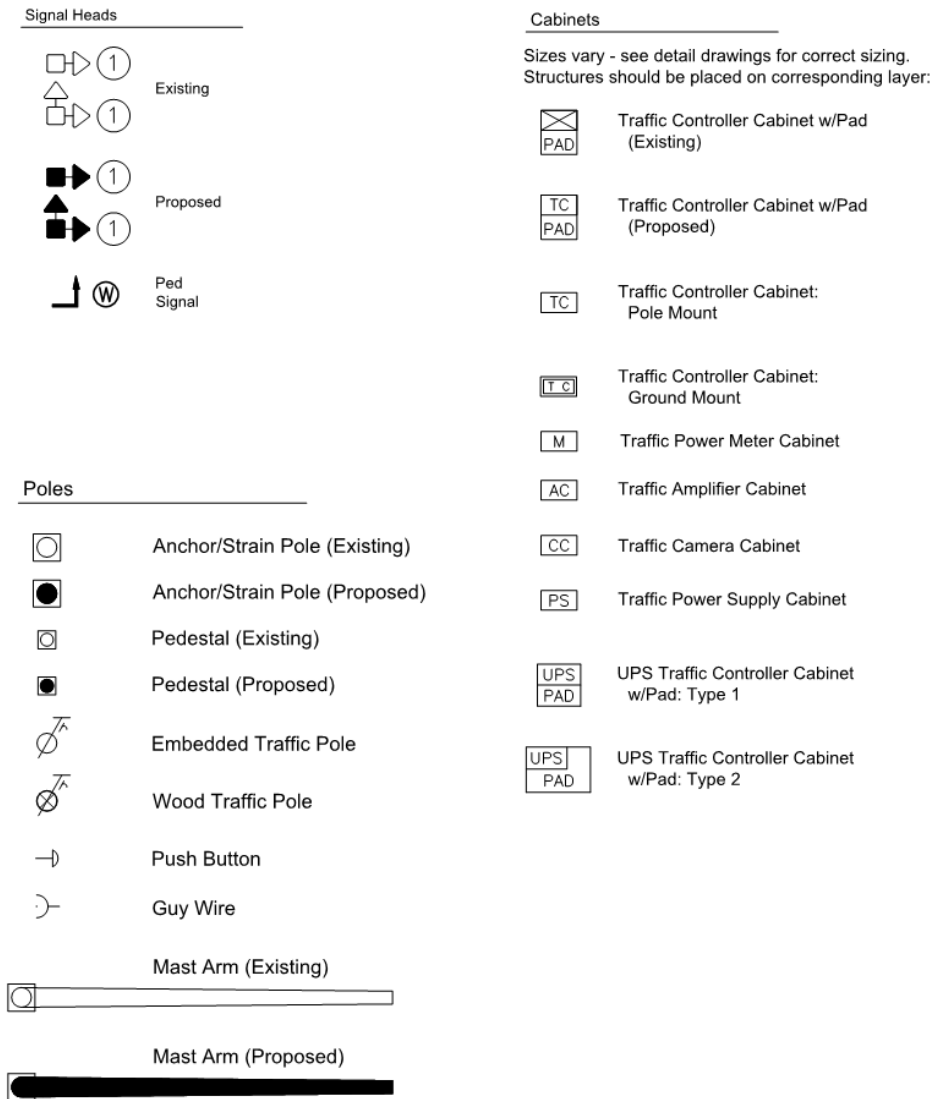

**Figure 2.1 (cont.)
Traffic Signal Symbols and Legend**





























Pullboxes	Pullboxes
Existing	Proposed
 18" x 12"	 18" x 12"
 17" x 12"	 24" x 13"
 18" x 13"	 27" round
 20" x 15"	 32" round
 21" x 16"	 48" round
 24" x 13"	
 25.5" x 16"	
 30" x 30"	
 30" x 30"	
 32.25" x 22.75"	
 48" x 30"	
 48" x 48"	
 10" round	
 18" round	
 27" round	
 32" round	
 48" round	
	<u>Detection/Monitors</u>
	 Traffic Flow Monitor
	 Dilemma Zone Radar Unit
	 Stop Line Radar Unit
	 Video Detection
	 Microwave
	 Z1 Zone
	 L1A Loops

Figure 2.2
Traffic Signal Wiring
Diagram Legend











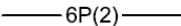

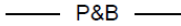



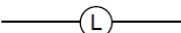

	Power Meter Cabinet
	2/C #6 AWG (Power)
	3/C #6 AWG (Power)
	#10 AWG Pole And Bracket Cable
	Signal Cable, # of Conductors
	Pedestrian Signal Head
	Vehicular Signal Head
	Pedestrian Pushbutton
	Luminaire, (Type)
	Connection of Distribution Cable to Pole and Bracket Arm Connector Kit Fused and Unfused.
	Distribution Cable #8 AWG (2 Wire)
	Dilemma Zone Radar Unit
	Stop Line Radar Unit
	Radar Detection Cable
	Video Detection Camera
	Video Detection Cable

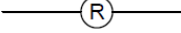
Figure 2.3
Grounding and Bonding
Diagram Legend

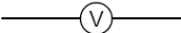
	Pull Box
	Ground Clamp with #4 AWG Wire Attachment Point
	Cabinet Ground Terminal
	Ground Rod and #4 AWG Wire
	Messenger Wire
	Traffic Signal Pole
	Traffic Signal Controller Cabinet
	#4 AWG Ground Wire

2.2 Plan Sheets

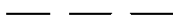
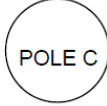
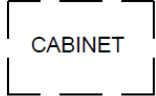
Sample plan sheets are available via the website link provided in **Section 1.2**.

2.2.1 Traffic Signal General Notes Sheet

Traffic signal general note sheets shall contain notes including standard reference notes, project specific notes, and traffic signal “As Per Plan” notes.

City of Columbus traffic signal notes are available via the website link provided in **Section 1.2**.

2.2.2 Traffic Signal Estimate of Quantities

An estimate of quantities should be provided for each signalized intersection in the project. Quantities should be totaled and carried to the General Summary when applicable. See **Section 2.3**.

2.2.3 Traffic Signal Removal Plan Sheet

The traffic signal removal plan sheet should be included when an existing traffic signal installation is being completely removed or fully replaced. The traffic signal item removals may be shown on the traffic signal plan sheet when the signal is being modified rather than fully replaced.

2.2.4 Traffic Signal Plan Sheet

The traffic signal plan sheet shall be furnished with the following drawing characteristics and design information:

Drawing Characteristics

- Where the major street of the intersection is greater than 50 ft. wide (measured from curb to curb or edge line to edge line), the traffic signal plan view should be drawn at a scale of 1"=20'. Where the major street pavement width is less than or equal to 50 ft., a scale of 1"=10' should be used so that the locations of poles, pull boxes, and conduits can be seen if the plans are plotted on paper for use in the field.
- Plan symbols for controller cabinets, pole foundations, pull boxes, and detection areas shall be drawn to scale accurately depicting the actual size of individual items.

The following design components shall be provided with each traffic signal improvement as applicable:

- Street names in drawing border (list alphanumerically)
- North arrow

- Scale bar
- Legend
- Centerline/stationing
- Pavement markings
- Pavement/curb/walk
- Underground utilities
- Overhead utilities
- Signal support/span mounted signs and sign legend
- Lane assignment/lane use arrows
- Street names on plan view
- Right-of-way
- Pedestrian signal head locations / orientation
- Vehicular signal head locations / orientation
- Pedestrian pushbutton locations / orientation
- Signal pole locations
- Controller location
- Pull box locations
- Conduit sizes and lengths
- Signal wiring identified for each conduit
- Power source location
- Signal plan sheet notes
- Signal head configuration legend
- Detection areas
- Removal chart
- Pushbutton sign legend

2.2.5 Traffic Signal Detail Sheet

The traffic signal detail sheet shall be furnished with the following design information as applicable:

- Phasing diagram, w/ Columbus intersection number
- Detector chart
- Wiring diagram and legend
- Field wiring hookup chart
- Timing chart
- Detail sheet notes
- Grounding and bonding wiring diagram
- Coaxial - Communication Interface Control Unit (CICU) chart (If applicable)

2.2.6 Traffic Signal Pole Fabrication and Orientation Data Sheet

The Traffic Signal Pole Fabrication and Orientation Data sheet shall be furnished with the following design information as applicable:

- Mast arm fabrication and orientation data chart
- Strain pole fabrication and orientation data chart

- Orientation legend
- Span wire diagram
- Signal support elevation detail

2.2.7 Traffic Signal Interconnect Sheets

For traffic signal interconnect requirements, see **Chapter 12**.

2.2.8 Maintenance of Traffic Temporary Signal Plans

Any work beyond the shifting of signal heads shall be detailed on separate, temporary traffic signal plan sheets. For temporary signal requirements, see **Chapter 3**.

2.2.9 Maintenance of Traffic Sheets (Head Shifts Only)

Work involving strictly the shifting or covering of signal heads can be included directly on the Maintenance of Traffic plan sheet for each associated construction phase. See Chapter 3, **Section 3.1.1** for plan requirements ("basic" modifications).

2.3 Estimate of Quantities

Typical traffic signal pay item descriptions are listed below. Quantities shall be furnished for each signalized intersection improvement.

ITEM	UNIT	DESCRIPTION
614	EACH	SPECIAL - WORK ZONE TRAFFIC SIGNAL
625	EACH	GROUND ROD
625	FT	NO. 4 AWG 600 VOLT DISTRIBUTION CABLE, AS PER PLAN
625	EACH	PULL BOX, 725.06, 12"X18" (TRAFFIC)
625	EACH	PULL BOX, 725.06, 13"X24" (TRAFFIC)
625	EACH	PULL BOX, 27"
625	EACH	PULL BOX, 32"
625	EACH	PULL BOX, 48", TYPE 1
625	EACH	PULL BOX, 48", TYPE 2
625	EACH	PULL BOX, MISC.: PULL BOX ADJUSTED TO GRADE
625	EACH	PULL BOX REMOVED, AS PER PLAN

ITEM	UNIT	DESCRIPTION
625	FT	TRENCH, AS PER PLAN [for use in non-paved areas]
625	FT	TRENCH IN PAVED AREA, TYPE A, AS PER PLAN [for use under pavement or walk less than 6" thick]
625	FT	CONDUIT, 2", 725.04
625	FT	CONDUIT, 3", 725.04
625	FT	CONDUIT, 1", 725.051
625	FT	CONDUIT, 2", 725.051
625	FT	CONDUIT, 3", 725.051
625	FT	CONDUIT, BORED, __", 725.052, AS PER PLAN
625	FT	CONDUIT, CONCRETE ENCASED, _____", 725.051 [not to be used for interconnect]
625	FT	CONDUIT MISC.: 3" CONDUIT, FIBERGLASS REINFORCED, ATTACHED TO STRUCTURE
625	FT	CONDUIT, MISC.: ENCASED INTERCONNECT CONDUIT BANK, 4-3", 2-2" & 1-1.5", TC-2, SCH 40
625	FT	CONDUIT, MISC.: ENCASED INTERCONNECT CONDUIT BANK, 4-3" & 1-1.5", TC-2, SCH 40
625	EACH	BRACKET ARM, 25', AS PER PLAN
625	EACH	BRACKET ARM, 30', AS PER PLAN
625	EACH	BRACKET ARM - LUMINAIRE, 8 FT, AS PER PLAN
625	FT	NO. 6 AWG 600 VOLT DISTRIBUTION CABLE
625	FT	NO. 8 AWG 600 VOLT DISTRIBUTION CABLE
625	FT	NO. 10 AWG POLE AND BRACKET CABLE
625	EACH	CONNECTION, FUSED PULL-APART
625	EACH	CONNECTION, UNFUSED PULL-APART
625	EACH	LUMINAIRE, ____W HPS, 120 V, TEARDROP (BLACK), AS PER PLAN
625	EACH	LUMINAIRE, LED, 120 V, TEARDROP (BLACK), AS PER PLAN
625	EACH	LIGHTING, MISC.: PHOTO CELL
630	EACH	SIGN HANGER ASSEMBLY, MAST ARM, AS PER PLAN
630	EACH	SIGN SUPPORT ASSEMBLY, POLE MOUNTED, AS PER PLAN
630	SF	SIGN, FLAT SHEET, AS PER PLAN
630	SF	STREET NAME SIGN
630	EACH	SIGNING, MISC.: TRAFFIC SIGNAL SIGNS

ITEM	UNIT	DESCRIPTION
632	EACH	VEHICULAR SIGNAL HEAD, L.E.D., 3-SECTION, 12" LENS, 1-WAY, ALUMINUM, AS PER PLAN*
632	EACH	VEHICULAR SIGNAL HEAD, L.E.D., 4-SECTION, 12" LENS, 1-WAY, ALUMINUM, AS PER PLAN*
632	EACH	VEHICULAR SIGNAL HEAD, L.E.D., 5-SECTION, 12" LENS, 1-WAY, ALUMINUM, AS PER PLAN*
632	EACH	VEHICULAR SIGNAL HEAD, L.E.D., 3-SECTION, 12" LENS, 1-WAY, POLYCARBONATE, AS PER PLAN*
632	EACH	VEHICULAR SIGNAL HEAD, L.E.D., 4-SECTION, 12" LENS, 1-WAY, POLYCARBONATE, AS PER PLAN*
632	EACH	VEHICULAR SIGNAL HEAD, L.E.D., 5-SECTION, 12" LENS, 1-WAY, POLYCARBONATE, AS PER PLAN*
		[* As Per Plan only necessary for mast arm installations]
632	EACH	PEDESTRIAN SIGNAL HEAD
632	EACH	PEDESTRIAN SIGNAL HEAD, AS PER PLAN [special area districts only]
632	EACH	PEDESTRIAN PUSHBUTTON
632	EACH	SIGNALIZATION, MISC.: APS PUSHBUTTON STATION
632	EACH	DETECTOR LOOP
632	EACH	SIGNALIZATION, MISC.: DILEMMA ZONE RADAR DETECTION SYSTEM
632	EACH	SIGNALIZATION, MISC.: STOP LINE RADAR DETECTION SYSTEM
632	EACH	SIGNALIZATION, MISC.: VIDEO DETECTION SYSTEM
632	EACH	STRAIN POLE FOUNDATION
632	EACH	STRAIN POLE FOUNDATION (BY DEPTH), AS PER PLAN
632	EACH	SIGNAL SUPPORT FOUNDATION
632	EACH	SIGNAL SUPPORT FOUNDATION (BY DEPTH), AS PER PLAN
632	EACH	PEDESTAL FOUNDATION
632	EACH	SIGNALIZATION, MISC.: FOUNDATION PRE-EXCAVATION
632	EACH	SIGNAL SUPPORT, TYPE 4120, DESIGN __, AS PER PLAN
632	EACH	COMBINATION SIGNAL SUPPORT, TYPE 4120, DESIGN ____, , AS PER PLAN
632	EACH	SIGNAL SUPPORT, TYPE 4121, DESIGN ____, AS PER PLAN
632	EACH	COMBINATION SIGNAL SUPPORT, TYPE 4121, DESIGN ____, AS PER PLAN
632	EACH	STRAIN POLE, TYPE 4170, DESIGN ____, AS PER PLAN

ITEM	UNIT	DESCRIPTION
632	EACH	PEDESTAL SUPPORT, 5', TRANSFORMER BASE
632	EACH	PEDESTAL SUPPORT, 10.7', TRANSFORMER BASE
632	EACH	PEDESTAL SUPPORT, 10.7'
632	EACH	PEDESTAL SUPPORT, 12.7', TRANSFORMER BASE
632	EACH	PEDESTAL SUPPORT, 17.5', TRANSFORMER BASE
632	EACH	PEDESTAL SUPPORT, 21', TRANSFORMER BASE
632	EACH	WOOD POLE
632	EACH	DOWN GUY
632	FT	MESSENGER WIRE, 7 STRAND, ____ INCH DIA. WITH ACCESSORIES [for signal span wire only]
632	FT	MESSENGER WIRE, 7 STRAND, .25 INCH DIA. WITH ACCESSORIES, AS PER PLAN [for interconnect only]
632	FT	TETHER WIRE, WITH ACCESSORIES
632	FT	SIGNALIZATION MISC.: DELASHING AND RELASHING OF CABLE
632	FT	INTERCONNECT CABLE, MISC.: OVERLASH TO EXISTING INTERCONNECT
632	FT	SIGNAL CABLE, 4 CONDUCTOR, NO. 14 AWG
632	FT	SIGNAL CABLE, 7 CONDUCTOR, NO. 14 AWG
632	FT	SIGNAL CABLE, 9 CONDUCTOR, NO. 14 AWG
632	FT	SIGNAL CABLE, 10 CONDUCTOR, NO. 14 AWG
632	FT	LOOP DETECTOR LEAD-IN CABLE, IMSA 50-2
632	FT	POWER CABLE, 2 CONDUCTOR, NO. 6 AWG
632	FT	POWER CABLE, 3 CONDUCTOR, NO. 6 AWG [used between transformer and meter cabinet at metered signals]
632	FT	POWER SERVICE, AS PER PLAN
632	EACH	SIGNALIZATION, MISC.: POWER METER CABINET (BY TYPE), BASE MOUNT, WITH FOUNDATION
632	EACH	CONDUIT RISER, 2", SCH 80 (Gray), 725.053 [for power cable]
632	EACH	COVERING OF VEHICULAR SIGNAL HEAD
632	EACH	COVERING OF PEDESTRIAN SIGNAL HEAD
632	EACH	COVERING OF PEDESTRIAN PUSHBUTTON
632	EACH	REMOVAL OF TRAFFIC SIGNAL INSTALLATION
632	EACH	REUSE OF (ITEM)

ITEM	UNIT	DESCRIPTION
632	EACH	CONDUIT RISER, 2", 725.04, MODIFIED, AS PER PLAN [for interconnect cable]
632	EACH	SPREAD SPECTRUM RADIO, AS PER PLAN
632	EACH	SIGNALIZATION MISC.: CCTV IP-CAMERA SYSTEM
632	EACH	INTERCONNECT, MISC.: FIBER OPTIC SPLICE ENCLOSURE, DOME, 800 SPLICE
632	EACH	INTERCONNECT, MISC.: FIBER OPTIC SPLICE ENCLOSURE, DOME, 288 SPLICE
632	EACH	INTERCONNECT, MISC.: FIBER OPTIC SPLICE ENCLOSURE, DOME, 144 SPLICE
632	FT	INTERCONNECT, MISC.: CAT 5E CABLE, OUTDOOR RATED
632	FT	INTERCONNECT CABLE, FIBER OPTIC, MULTIMODE, 6- STRAND, AS PER PLAN
633*	EACH	CONTROLLER UNIT TS2/A2, W/CABINET 16 CH, M36 STRECH, POLE MOUNTED, AS PER PLAN
633	EACH	CONTROLLER UNIT TS2/A2, W/CABINET 16 CH, SIZE 6, GROUND MOUNTED, AS PER PLAN
633*	EACH	CONTROLLER UNIT, TYPE TS2/A2, WITH P-UPS CABINET, 16 CH, GROUND MOUNTED, AS PER PLAN
633	EACH	CABINET FOUNDATION
633	EACH	CONTROLLER WORK PAD
633	EACH	UNINTERRUPTIBLE POWER SUPPLY (UPS), 1000 WATT, AS PER PLAN
633	EACH	PREEMPTION, AS PER PLAN
633	EACH	CONTROLLER ITEM, MISC.: FIBER OPTIC ETHERNET TRANSCEIVER, SHORT RANGE
633	EACH	CONTROLLER ITEM, MISC.: FIBER OPTIC ETHERNET TRANSCEIVER, LONG RANGE
633	EACH	CONTROLLER ITEM, MISC.: LAYER 2 ETHERNET SWITCH
633	EACH	CONTROLLER ITEM, MISC.: LAYER 3 ETHERNET SWITCH
1620	EACH	FIBER OPTIC FUSION SPLICE
1620	FT	MISC.: FIBER OPTIC CABLE, ____ STRAND
1620	EACH	MISC.: TERMINATION PANEL, 24 FIBER

* This item is to be used only when directed by the City of Columbus.

CHAPTER 3: TEMPORARY TRAFFIC SIGNALS AND INTERCONNECT

3.1 Temporary Traffic Signals

All components of a temporary traffic control system shall be designed in accordance with the requirements of the current version of the [City of Columbus Construction and Material Specifications](#) as well as the [Ohio Manual of Uniform Traffic Control Devices](#).

Temporary traffic signals addressed herein are limited to temporary installations used to accommodate construction operations at existing signalized intersections. The use of portable signals or temporary setups to facilitate one-lane, two-way operation is addressed in the [Ohio Manual of Uniform Traffic Control Devices, Section 4D.32](#).

An existing traffic signal, or any part thereof, shall not be taken out of service unless alternate means of traffic control are in place and operational. Unless directed by the City of Columbus, City Engineer or appointed designee existing traffic signals shall not be taken out of service between the hours of:

- 7:00 AM to 9:00 AM Monday through Friday and
- 4:00 PM to 6:00 PM, Monday through Friday.
(3:30 PM to 6:00 PM for the Downtown Business District)

Additionally, existing traffic signals shall be operational from:

- One hour before sunset to one-half hour after sunrise.

Outages during permitted times shall be controlled by an off-duty uniformed police officer hired by the Contractor. When outages are due to construction operations extending beyond permitted times, temporary signalization or modifications will be required.

Modification to an existing traffic signal for maintenance of traffic during construction shall be detailed in the plans. The level of detail included in the plans depends on the amount of modification work required to keep the signal in operation during construction. The plan requirements for temporary signal work have been broken into three tiers as outlined in the sections below and in **Table 3.1** and are based on the amount of temporary work required. Also refer to the Sample Plan sheets for additional guidance and requirements for each of the three tiers.

3.1.1 Basic Temporary Signal Modifications

Basic temporary signal modifications include signal head shifts due to lane closures or lane shifts, covering of unused vehicular signal heads, and/or

covering of unused pedestrian pushbuttons and signal heads as a result of a crosswalk closure.

Temporary signal setups associated with this tier typically make use of the existing poles, cabinet, timing, and phasing (basic temporary signal plans may omit phases).

Basic temporary signal modifications may be shown on the standard maintenance of traffic sheet and do not require separate temporary signal plan sheets.

The following components shall be included for basic temporary signal modifications:

- All existing signal heads shown in their original, pre-construction position as well as their relocated position
- Any omitted phases listed via plan sheet note
- Temporary detection note (zones and detection unit do not need to be graphically depicted)
- Note stating that unused pedestrian signal heads and pushbuttons shall be covered
- Any other applicable standard plan notes

3.1.2 Intermediate Temporary Signal Modifications

Intermediate temporary signal modifications typically include the installation of one or more temporary signal pole, or modification to an existing signal span.

Intermediate temporary signal modifications typically use the existing cabinet and phasing (but may omit phases).

Intermediate temporary signal modifications shall be shown on separate temporary signal plan sheets. Including intermediate-level modifications on the standard maintenance of traffic sheet requires advance authorization from the City of Columbus City Engineer or appointed designee.

The following components shall be included for intermediate temporary signal modifications:

- Components listed in **Section 3.1.1** for a basic temporary signal modification

- Graphic location of temporary or relocated signal poles (exact station and offset not required)
- Graphic representation of temporary span configuration
- Location and phase of any added or shifted temporary detection zones on the plan view only (zones that are deactivated are covered by plan sheet note)
- Detection chart for any added or shifted temporary zones
- Any other applicable standard plan notes

3.1.3 Detailed Temporary Signal Plans

Detailed temporary signal plans are required when a temporary cabinet is required or phasing needs to be modified (beyond omitting phases) to accommodate the maintenance of traffic setup.

Detailed temporary signal plans shall be shown on separate temporary signal sheets.

The following components shall be included for detailed temporary signal plans:

- Components listed in **Sections 3.1.1 and 3.1.2** for basic and intermediate temporary signal modifications, respectively
- Temporary phasing diagram and/or timing chart as applicable
- Temporary detection zones and phase
- Applicable plan notes
- Note and plans to maintain interconnect to the existing or temporary cabinet (e.g. replace the drop cable to the temporary cabinet or use radio); see **Section 3.8**.

Table 3.1
Summary of Temporary Signal Plan Tier Requirements

Item to be shown on plan sheet	Basic	Intermediate	Detailed
Vehicular signal heads	Yes	Yes	Yes
Pedestrian signal heads	No	No	No
Pedestrian pushbuttons	No	No	No
Existing signal poles	Yes	Yes	Yes
Temporary wood poles	N.A.	Yes	Yes
Wood pole station/offset	N.A.	No	No
Pole elevation details	N.A.	No	No
Span mounted signs	Yes	Yes	Yes
Pole mounted signs	No	No	No
Down guys	N.A.	No	No
Span diagram	No	No	No
Field wiring hook up chart	No	No	No
Timing chart	No	No	Yes
Phasing diagram	No	No	Yes
Detection chart	No	Yes	Yes
Temporary detection locations	No	Yes	Yes
Wiring diagram	No	No	No
Grounding and bonding diagram	No	No	No
Power service details	No	No	No
Interconnect details	No	No	Yes ⁽³⁾
Utilities	No	Yes	Yes
Applicable temp signal plan notes	Yes	Yes	Yes

Notes:

1. Basic modifications may be shown on standard MOT plan sheets. Intermediate and Detailed modifications shall be shown on dedicated temporary signal plan sheets.
2. All items marked as "Yes" are to be included only if applicable.
3. See Section 3.8 for temporary interconnect requirements.

3.2 Temporary Signal Supports

Temporary traffic signal supports may consist of relocated anchor base strain poles, relocated mast arm supports, or the installation of wood poles. When temporary signal supports are used, the following shall be considered when determining a location for pole placement:

- Location of existing and proposed infrastructure.
- The existing mast arm length if the structure is to be relocated.
- A non-active traffic signal head shall not block the view of an active traffic signal head.
- Temporary signal supports should maintain minimum clearances from both existing and proposed signal supports as specified in **Section 4.3.3**.
- The proximity of proposed foundations to existing foundations/supports shall be considered.
- A temporary traffic signal system shall not interfere with the excavation of a proposed pole/cabinet foundation.
- A temporary traffic signal system shall be designed to accommodate all vehicular traffic signal head shifts for each maintenance of traffic phase.
- Temporary signal supports shall not be located in proposed pavement, curb ramps, or shared use path; similarly, existing signal supports shall not remain in these locations and shall be replaced with temporary signal supports located outside these locations.

3.2.1 Span Wire Temporary Traffic Signals

Standardized notes shall be included on temporary signal plans stating that the contractor shall size poles and adjust the span to accommodate the clearances specified in **Section 5.2.3**.

If the existing span wire system is to be used in the temporary setup, then the temporary poles shall be located to allow for the transfer of the existing span wire system from the existing strain pole to the temporary pole.

3.3 Temporary Vehicle Detection

Notes shall be provided stating that existing vehicle detection shall be maintained whenever a traffic signal is in operation and not controlled by a uniformed police officer. When construction activities remove or deactivate existing vehicle

detection, temporary detection (loops, video detection, radar, or other City-approved technology) shall be provided. See **Sections 3.1.2 and 3.1.3** for plan requirements.

3.4 Temporary Vehicular Signal Heads

Temporary signal plans should clearly detail the location of the temporary signal heads graphically for each phase of construction. Head placement guidelines are provided in **Section 5.2**.

When the existing signal heads have blackplates, the temporary signal heads shall be specified with backplates. All signal heads with backplates shall be specified as tethered.

Backplates for temporary signal heads are not required when the existing signal heads do not have backplates.

3.5 Temporary Pedestrian Features

Temporary pedestrian facilities (pedestrian pushbuttons and signal heads) shall be addressed via standardized temporary signal plan notes (notes provided by the City).

When temporary signal phasing is used, crosswalks intended to be open during a particular MOT phase shall be illustrated in the temporary signal phasing diagram.

3.6 Temporary Pavement Markings and Signs

All applicable span/mast arm mounted signs shall be clearly identified in the plan.

When used, a temporary stop line shall be located to allow adequate clearance for turning vehicles and maintain the signal head to stop line spacing requirements outlined in **Section 5.2.2**.

3.7 Temporary Signal Wiring and Controller Cabinets

Temporary traffic signal cabinets may be either base-mounted or pole-mounted. Pole mounted cabinets shall be positioned to prevent an overhang greater than 4 in. into a pedestrian pathway. When feasible, a temporary traffic signal cabinet/controller shall be located on the same corner as the existing cabinet/controller.

3.8 Temporary Interconnect Plan

When existing traffic signal interconnect is identified within the limits of the project and is impacted by proposed work, a temporary interconnect plan shall be developed and submitted with Stage 2 plans. For most interconnect communication cables, the Department of Technology (DoT) also has active circuits on them and shall be accounted for along with the Department of Public Service. Maintaining these communication cables is critical due the various public safety services (Fire, Police, etc.) using the DoT circuits.

When feasible, existing interconnect should be left in place to maintain connectivity throughout construction. Once the permanent cable is in place, service can be transferred from the existing cable to the new cable.

If the existing cable cannot be maintained until the time that the permanent cable is in place, temporary cable shall be installed and detailed on separate temporary interconnect plan sheets. Plan components shall be as described in **Section 3.8.1**.

Temporary wireless radios or cell modems are alternative forms of maintaining communication and may be used in certain conditions. However, these technologies do not have enough bandwidth to transmit data on sections of cable in use by the Department of Technology, for connected vehicle systems, or when a traffic flow monitor is connected.

Temporary wireless radios or cell modems may be considered when these uses are not present. The use of these alternative forms of temporary interconnect requires advance authorization from the City of Columbus City Engineer or appointed designee.

3.8.1 Temporary Interconnect Plan Components

Temporary interconnect plans should generally provide a similar level of detail as permanent interconnect plans. The plan components that will be required will depend on the amount of modification work required to maintain communications throughout construction.

Depending on the nature of the impact to existing interconnect cables, temporary interconnect plans may include, but shall not be limited to, the components listed below.

- Plan views showing the following:
 - Existing poles or conduit and existing interconnect cables
 - Existing pull boxes
 - Temporary cables
 - Temporary wood poles

- Temporary conduit
- Existing and/or temporary splice enclosure locations
- Additional cable slack locations
- Plan notes specific to temporary interconnect
- Temporary communication diagrams (splicing details)

Requirements related to cable types, installation, relocation, and splicing shall be as outlined for permanent interconnect in **Chapter 12**.

CHAPTER 4: SUPPORTS AND FOUNDATIONS

Traffic signal supports and foundations shall be furnished in accordance with Sections 632 and 732 of the current version of the [City of Columbus Construction and Material Specifications](#).

Supports and foundations shall also be in accordance with the City of Columbus [Qualified Products List](#).

4.1 Traffic Signal Supports

The type of signal support used in new signal installations in the City of Columbus shall be per the project scope.

4.1.1 Standard Mast Arm Supports

Standard mast arm supports shall be per [City of Columbus Standard Construction Drawing 4120](#).

The Ohio Department of Transportation's [Traffic Engineering Manual](#), Section 440-3 (Single-Arm Overhead Signal Support) should be referenced when determining mast arm support sizes, with the following exceptions:

- Supports specified for City of Columbus projects should be limited to Columbus designs 4, 12, 13, 14, and C15. The use of supports larger than those listed must be approved by the City of Columbus, City Engineer or appointed designee.
- Pole details shall be per City of Columbus Standard Construction Drawings.
- When evaluating retrofit applications, the existing signal supports may not have been furnished/installed using current design standards. City of Columbus record plan information should be evaluated.
- Maximum design values for C15 poles shall be as listed below:
 - C15: Max. K = 3930
 - Max. Design Area = 50 sf.
 - Max. Arm Length = 79 ft.

4.1.2 Decorative Mast Arm Supports

Decorative mast arm supports shall be per [City of Columbus Standard Construction Drawing 4121](#).

Decorative mast arm support sizing should be calculated as indicated in **Section 4.1.1**.

Decorative mast arm supports may use combination lighting if the photometric analysis indicates a luminaire is needed close to the mast arm support. When used, the combination lighting shall adhere to the requirements specified in **Section 7.7**.

When combination lighting is used, the luminaire bracket arm does not necessarily need to be aligned with the bracket arm and may be rotated based on photometric needs.

4.1.3 Double Mast Arm Supports

Double mast arm supports may only be used when conflicts (right-of-way, utilities, etc.) prevent the use of a single arm layout as detailed in **Section 4.3**. Additionally, double mast arm supports may only be used with prior approval from the City of Columbus, City Engineer or appointed designee.

A design C16 pole shall be used for all double arm supports. Loading and arm length criteria may not be exceeded.

Maximum design values for C16 poles shall be as listed below:

C16: Max. K = 2367 for each arm
Max. design area = 48 sf. for each arm
Max. arm length = 50 ft. for each arm

4.1.4 Strain Poles

When authorized by the City of Columbus, City Engineer or appointed designee, span wire/strain poles may be used for new traffic signal installations. All new span wire applications shall be designed with a bottom tether and accommodate 12 in. signal heads with backplates.

When modifying an existing intersection that does not currently have backplates and bottom tethers, the addition of tethers and backplates will not be required if the designer determines the poles cannot support the additional loading associated with those items. If a bottom tether cannot be used, then free swinging aluminum heads without backplates shall be submitted for review.

Strain poles shall be per [City of Columbus Standard Construction Drawing 4170](#).

4.1.4.1 Strain Pole Sizing

Strain poles shall be sized using the Ohio Department of Transportation's [Span Wire Signal Support](#) software (SWISS.) This software is free and can be downloaded from the Ohio Department of Transportation's web site.

SWISS calculations shall be submitted with the signal plans second submittal for each new or modified span wire design. Calculations should be provided for the following three scenarios:

- 3 percent sag (used to determine pole size).
- 4 percent sag (used to establish attachment height).
- 5 percent sag (used to establish pole height). 2 ft. should be added to the 5 percent pole attachment elevation to determine pole height.

Additionally, proposed pole heights shall accommodate traffic signal power, interconnect and bracket arm attachment needs. Clearance from overhead utilities shall also be considered when establishing proposed pole heights.

Poles shall be upsized to provide for uniformity at a given intersection, but not increased by more than one additional size from that calculated using the SWISS software.

4.1.4.2 Span Configuration

A pole-to-pole span wire configuration is the preferred layout for strain pole applications and should be used when feasible.

A suspended box or a combination of pole-to-pole/suspended box span configuration may be necessary, especially at larger intersections, in order to meet the following goals for span design:

- 1) Overhead utilities do not block the signal heads
- 2) Spans are perpendicular to the approach lanes
- 3) Signal heads no greater than 180 feet from the stop line
- 4) Signal heads 2 ft. or greater outside the extension of the face of curb of the intersecting street (deviation from this goal may be required in order to meet goal #3)

A diagonal span shall not be used unless specifically directed by the City of Columbus City Engineer or appointed designee. If an existing diagonal span or other configuration is affected by a project, the span layout shall be replaced with an acceptable span

configuration.

Output from SWISS software must indicate that the system is in balance.

4.1.5 Pedestal Supports

Each mast arm or strain pole should be positioned to accommodate the location requirements of a pedestrian pushbutton and/or pedestrian signal head. Pedestal supports should be used when a mast arm or strain pole cannot be positioned to accommodate the location requirements of a pedestrian pushbutton or pedestrian signal head. Pedestal supports shall also be used at a typical intersection to provide a compliant pedestrian pushbutton or signal head location for any ramp without an adjacent mast arm or strain pole. See **Section 4.3.5** for additional requirements regarding pushbutton placement.

Pedestal supports may also be used where a mast arm or strain pole is not available to provide support for supplemental vehicular signal heads or street name signs.

The height of the pedestal shall correlate with the items mounted on the pedestal. Pedestal heights and uses are listed in this section.

Where feasible, the pedestal transformer base door (SCD 4100-4104) or handhole (SCD 4106) shall be oriented opposite to PAR/ramp/walk area. The angle at which the handhole or transformer base door is to be oriented shall be identified in the pole fabrication chart under the "Handhole" column.

4.1.5.1 5 ft. Pedestal

A 5 ft. pedestal should be used when only a pedestrian pushbutton is needed. ([City of Columbus Standard Construction Drawing 4100](#))

4.1.5.2 10.7 ft. Pedestal

A 10.7 ft. pedestal should be used when only a pedestrian signal head is needed or if both a pedestrian signal head and a pushbutton are needed. ([City of Columbus Standard Construction Drawing 4101](#))

A 10.7' pedestal with a pedestrian signal head should be provided in a pushbutton-compliant location for each crosswalk when feasible to accommodate future APS pushbutton installation.

4.1.5.3 12.7 ft. Pedestal

A 12.7 ft. pedestal may be used to support an auxiliary vehicular signal head. ([City of Columbus Standard Construction Drawing 4102](#))

4.1.5.4 17.5 ft. Pedestal

A 17.5 ft. pedestal may be used when a street name sign is mounted on the same pedestal support as another traffic signal control device. A 17.5 ft. pedestal should not be used if its only purpose is to support a street name sign. A 17.5 ft. pedestal should not be used to mount auxiliary vehicular signal heads. ([City of Columbus Standard Construction Drawing 4103](#))

4.1.5.5 21 ft. Pedestal

A 21 ft. pedestal should be used to support an auxiliary vehicular signal head. The auxiliary vehicular signal head should be mounted at the same height as vehicular heads mounted on span wire or a mast arm. ([City of Columbus Standard Construction Drawing 4104](#))

4.1.6 Bracket Arms

Bracket arms shall be used to support luminaires, video detectors, and traffic flow monitors. Bracket arms may also be used to support radar detectors. Bracket arms and available sizes are detailed in the [City of Columbus Standard Construction Drawing 4110](#).

4.1.7 Finish Requirements

Signal supports, pedestals, strain poles, bracket arms, anchor bolt covers, and associated mounting hardware shall be coated to match Federal Standard 595B, color number 27038 (semi-gloss black), unless they are located in a special area district or as approved by the City of Columbus, Director of the Department of Public Service or appointed designee.

New signal supports, pedestals, or bracket arms added to an existing signal installation shall match the finish of the other existing supports.

4.1.7.1 Special Area Districts

In designated special districts, signal supports may be coated with a color other than black as approved by the City of Columbus, Director of the Department of Public Service or appointed

designee. These specially colored supports will be supplied (for initial installation and for maintenance) by the Sponsor, “governing authority” of the special district pursuant to a written installation and maintenance agreement.

4.2 Traffic Signal Support Foundations

Pole and pedestal foundation elevations shall be shown to the nearest hundredth of a foot. Foundation elevations shall be listed in the pole orientation chart and/or identified on the curb ramp detail sheets. A minimum of 2 conduits shall enter each foundation for all mast arms, strain poles, and pedestals. For any intersection corner where a strain pole exists but there is no pull box, an unused, capped conduit ell shall be specified with an orientation illustrated in the pole fabrication and orientation chart. See **Figure 4.8**.

4.2.1 Mast Arm and Strain Pole Foundations

Mast arm and strain pole foundations shall be as detailed on [City of Columbus Standard Construction Drawing 4160](#). When a support structure exceeds standard sizes, a custom foundation may be required. If a pole mounted traffic signal cabinet is used, the minimum number of conduits installed in the foundation shall be (2) - 2 in. and (1) - 3 in.

In circumstances where the five foot minimum underground utility clearance outlined in **Section 4.3.3** cannot be met for a proposed mast arm or strain pole foundation, a deep foundation may be used with prior approval by City of Columbus, City Engineer or appointed designee.

The specifications of deep foundations are outlined in [City of Columbus Standard Construction Drawing 4160](#). When used, the deep foundation depth shall be identified in the plans via the pole callout.

4.2.2 Pedestal Foundations

Pedestal foundations shall be as detailed on [City of Columbus Standard Construction Drawing 4163](#).

When a pushbutton pedestal is installed behind the walk, the foundation shall use an 18 inch formed top as specified in [City of Columbus Standard Construction Drawing 4163](#).

When installed behind the walk, the pedestal foundation shall be immediately adjacent to the walk to meet the 10” ADA reach requirement. The 18” formed top foundation shall be integral to the curb wall (if present) as shown on Standard Drawing 4163.

When it is necessary to install a pedestal with an 18" formed top adjacent to the back of existing walk, the existing sidewalk panel adjacent to the foundation must be replaced in order to excavate the 24" diameter foundation below the 18" formed top.

When used, the 18" formed top foundation shall be identified in the plans via the pole callout.

4.3 Traffic Signal Support Placement

Determining the proposed location of a traffic signal support shall be based on the design considerations outlined in **Sections 4.3.1** through **4.3.8**.

4.3.1 General Location

A single mast arm structure should be provided for each approach located on the far right side of the approaching leg. Alternate placement must be approved by the City of Columbus, City Engineer or appointed designee.

4.3.2 Clear Zone

Signal supports shall be located in accordance with Section 600.2, (Clear Zone) of the [Location and Design Manual, Volume 1](#), (L&Dv1) (Ohio Department of Transportation). These offsets shall be measured from the edge of the pole skirting/outside edge of base plate or outside edge of the pole, not the center of the pole.

4.3.3 Underground Utility Clearance

Placement of new signal pole foundations should provide for 8 ft. of horizontal clearance from adjacent utilities or structures on any new construction. A minimum of 5 ft. of horizontal clearance from utilities and from existing signal pole foundations shall be maintained at any location where 8 ft. is not feasible due to existing permanent obstructions. If a proposed signal pole must be installed within 5 ft. of the existing signal pole, a temporary signal pole shall be provided. Additional clearance requirements for other underground traffic related infrastructure are outlined in **Section 13.2.3**. Clearance distances are measured from the outside edge of the foundation to the nearest edge of the adjacent utility trench.

When deep foundations for mast arm or strain poles are used, the minimum clearance shall be reduced to 3 ft. Clearance distances are measured from the outside edge of the foundation to the nearest edge of the adjacent utility trench.

Excavation for existing utility replacement/repair or for proposed signal pole foundations will not be permitted within 5 ft. of any existing traffic signal support without proper shoring or trench walls and approval by the City of Columbus, City Engineer or appointed designee. Any removed material within 5 ft. of the signal pole foundation shall be replaced with controlled density fill (CDF). The limits of the CDF replacement as well as the density will need to be calculated by the design engineer.

Excavation between 5 ft. and 8 ft. and will require temporary support (down guy, head guy, base guy, mechanical/crane support, etc.).

Pedestrian pedestal foundations shall provide for 3 ft. of horizontal clearance from adjacent utilities or structures. Additional clearance requirements for other underground traffic related infrastructure are outlined in **Section 13.2.3**. Clearance distances are measured from the outside edge of the foundation to the nearest edge of the adjacent utility trench.

4.3.4 Overhead Utility Clearance

Traffic signal support structures shall maintain applicable clearances from other overhead utilities as listed in the [National Electrical Safety Code](#), [National Electrical Code](#) and the regulations published by the [Occupational Safety and Health Administration](#) (OSHA) addressing installation and maintenance tasks.

Table 4.1
Overhead Utility Clearances

	National Electric Safety Code Reference	National Electric Code Reference
Vertical Clearance from: ground, road, rail, etc.	Section 232	225.18
		230.24
		230.26
Clearance between wires on different supporting structures	Section 233	N.A.
Clearance between wires and structures	Section 234	225.19

Section references listed in Table 4.1 are based on the 2020 National Electrical Code and the 2017 National Electrical Safety Code. However, the designer is required to reference the most recent publication of these documents.

In addition to the requirements outlined in **Table 4.1**, pole placement shall also consider the regulations published in Section 1926 of [29 CFR \(OSHA\) Safety and Health Regulations](#) for Construction.

These regulations require that all conductive components of a traffic signal maintain a minimum clearance of 10 ft. in all directions (“radially”) from all electrical cables, including the neutral, associated with voltages up to 50kV to ground. Voltages higher than 50kV to ground shall provide clearances in accordance with the requirements of Table A of OSHA 1926.1408.

In locations where overhead City of Columbus street lighting will be in the vicinity of an intersection, a clearance of 5.0’ radially shall be maintained from all signal structures. All other overhead street lighting requires clearances in accordance with OSHA 1926.1408.

When additional clearance is required by the [National Electrical Safety Code](#), [National Electrical Code](#) or the regulations published by [OSHA](#), the more restrictive clearance shall be maintained.

Communications lines shall not block the visibility of signal heads or rest on signal supports, mast arms, or signal spans.

These overhead utility clearance requirements are illustrated in **Figures 4.1 through 4.3**.

It is the responsibility of the designer to identify overhead utility conflicts and clearance violations during design. This may require obtaining existing elevations of cables on utility poles via survey and shall be provided to the City of Columbus upon request. The disposition of overhead utilities shall be specified in the plans and the designer shall communicate required relocations to the applicable utility.

Figure 4.1
Overhead Utility Clearance Illustration (Profile View)

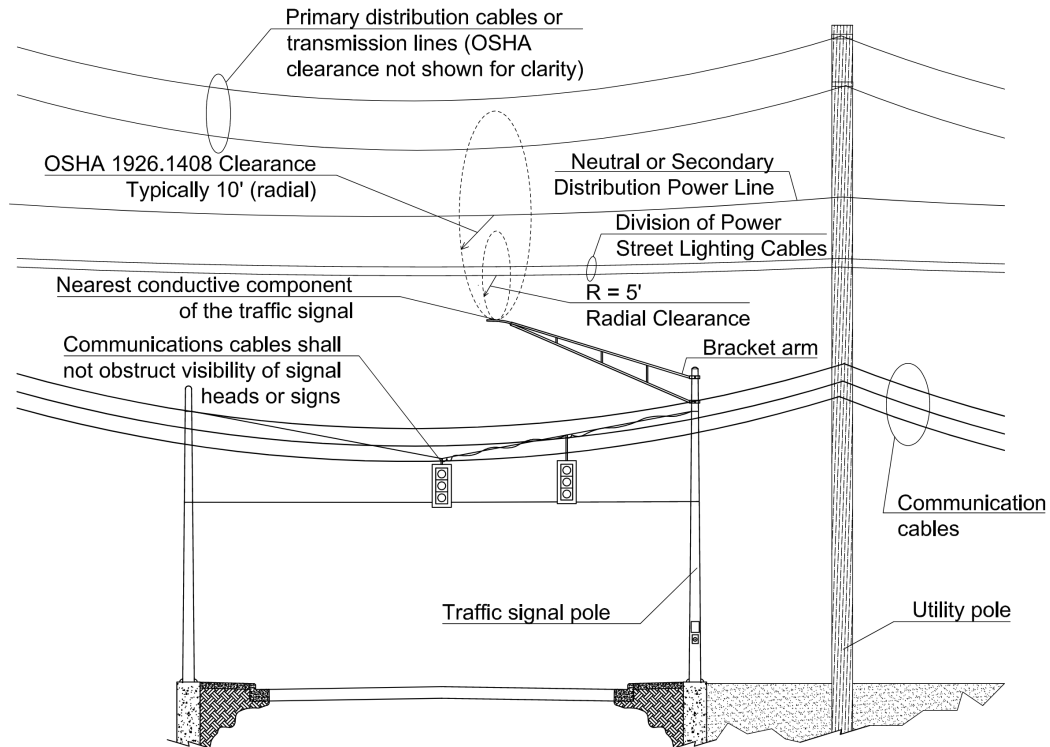

Figure 4.2
Overhead Utility Clearance Illustration (Strain Pole Cross-section View)

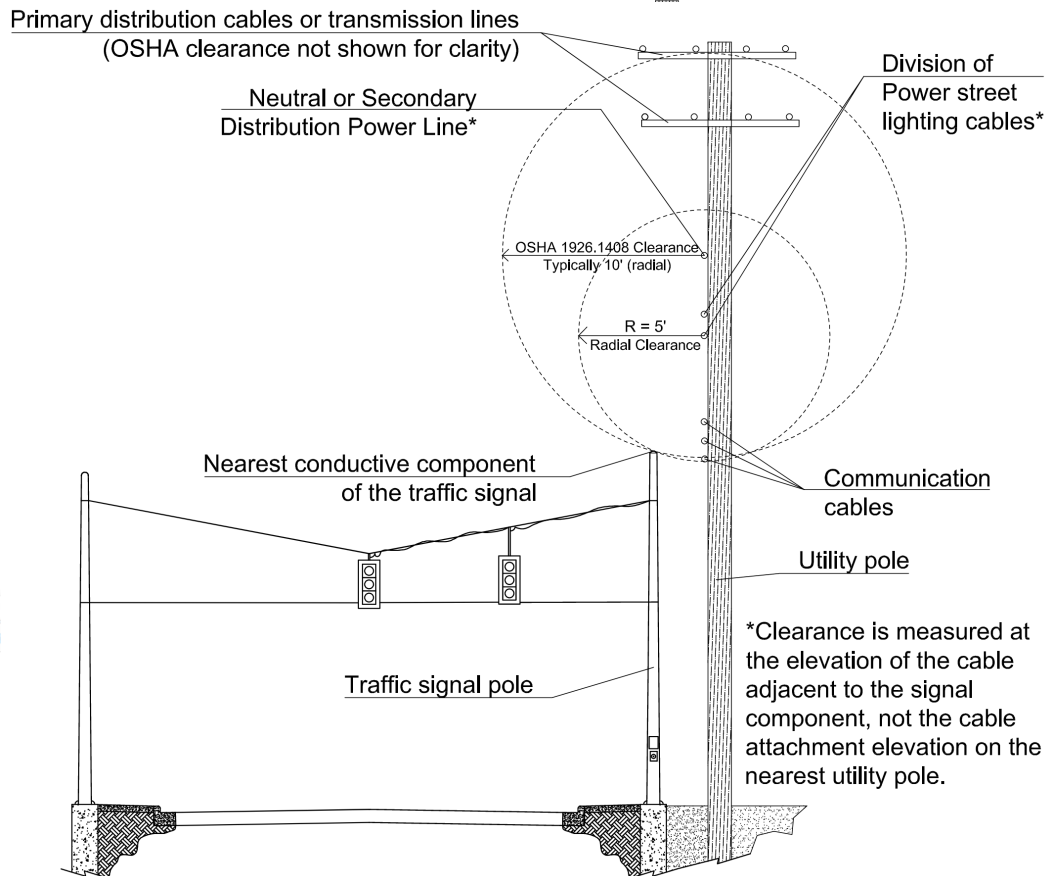
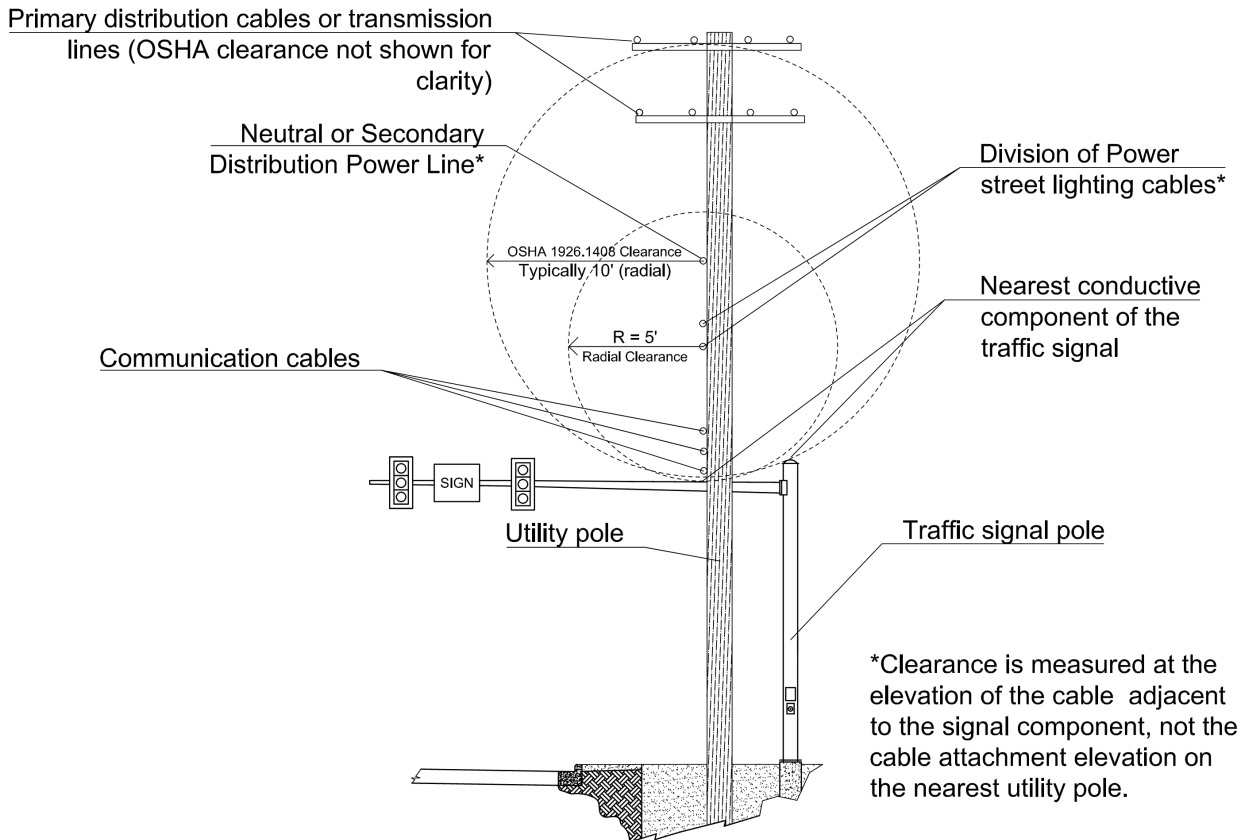

Figure 4.3
Overhead Utility Clearance Illustration (Mast Arm Cross-section View)



4.3.5 Pushbutton Location

When feasible, the mast arm or strain pole should be located to accommodate the pedestrian pushbutton positioned in accordance with **Section 6.2.2**. Should other design considerations discussed herein prevent the mast arm or strain pole from accommodating the pushbutton, a pedestal support shall be used to locate the pushbutton in an acceptable location as defined by [ADA Rules and Regulations](#), published by the City of Columbus.

4.3.6 Elevation

The ground/walk elevation at the location of the proposed support structure should be considered, as elevation differences between the roadway surface and support foundation can affect mast arm, span wire attachment and pole heights.

When a support structure is located within a sidewalk, bike path or multiuse path, the top of the foundation shall be in accordance with [City of Columbus Standard Construction Drawing 4161](#).

[City of Columbus Standard Construction Drawing 4160](#) should be referenced when a support structure is located in a non-paved area or adjacent to sidewalk, bike path or multiuse path areas. When the support structure is adjacent to sidewalks, bike paths or multiuse paths, the top of the foundation shall be flush with the paved surface.

4.3.7 Arm Length/Span Configuration

Maximum available mast arm lengths shall be considered when evaluating possible pole locations. In addition, to accommodate the proposed vehicular signal head and signage requirements, the following items shall be incorporated into the design.

- The mast arm shall extend a minimum of 2 ft. past the last proposed attachment point.
- Mast arms shall extend 2 ft. past the center of a current or future dedicated left turn lane, to accommodate the future application of a protected only left turn signal head.
 - Should this required head placement trigger the need for an increased pole size and if directed by the City of Columbus City Engineer or appointed designee, a shorter arm satisfying turn on day conditions may be placed on the larger designed vertical shaft.

When strain poles are used, pole locations will affect the span configuration. The span must be in balance per the requirements of **Section 4.1.4**.

4.3.8 Distance from Stop Line

Pole placement and the resulting head location with respect to the distance from the stop line shall conform to the requirements outlined in **Section 5.2.2**.

4.4 Plan Requirements

4.4.1 Pole Identification

Each support shall be identified with a leader and an individual callout. Support callouts shall list the pole identifier, pole type, pedestal size and station/offset to an accuracy of a tenth of a foot. The callout should also list what is on or attached to the pole (pushbutton, pedestrian signal head, bracket arm, etc.) and the depth of the pole foundation if a deep foundation is required. Support symbols illustrated on the plan shall accurately represent the outside diameter of the foundation.

Supports shall be identified based on their location and type. On each corner of an intersection signal supports shall always be numbered first and pedestrian pedestals shall be numbered next. Support identifier examples are provided below.

Example 1

Pole N/E -1 Combination Signal Support

W/ (1) – 25' Bracket Arm w/ Traffic Flow Monitor

W/ (1) – Pedestrian Signal Head

W/ (1) – Pedestrian Pushbutton

W/ (1) – Radar Detector for SB Approach

Station 000+00.0, 00.0' RT

Example 2

Pole N/E-2 Pedestrian Pedestal, 10.7'

W/ (2) – Pedestrian Signal Heads

W/ (1) – Pedestrian Pushbutton

Station 00+00.0, 00.0' RT

Example 3

Pole S/W-1 Strain Pole w/ Deep Foundation (24')

W/ (1) – Pedestrian Signal Head

W/ (1) – Auxiliary Signal Head

Station 00+00.0, 00.0' LT

Example 4

Pole S/E-2 Pedestrian Pedestal, 10.7', W/ 18" Formed Top Foundation

W/ (1) – Pedestrian Signal Head

W/ (1) – Pedestrian Pushbutton

Station 00+00.0, 00.0' LT

4.4.2 Pole Orientation and Fabrication Data

A pole fabrication chart, orientation diagram, and elevation view shall be provided detailing the pole identification number, pole color, foundation elevations, pole design number, pole height, span attachments, mast arm lengths, field orientation angles, and pole item installation angles. Sample diagrams are provided in **Figure 4.4** through **Figure 4.8**.

Figure 4.4
Typical Mast Arm Fabrication and Orientation Data

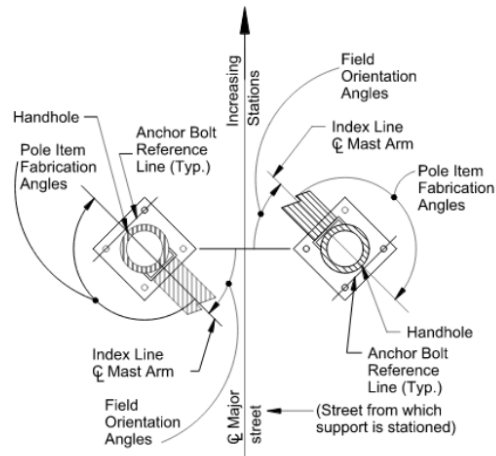

All angles measured clockwise.
 Base plate is oriented square to Mast Arm.

TYPICAL SIGNAL SUPPORT
ORIENTATION DETAIL

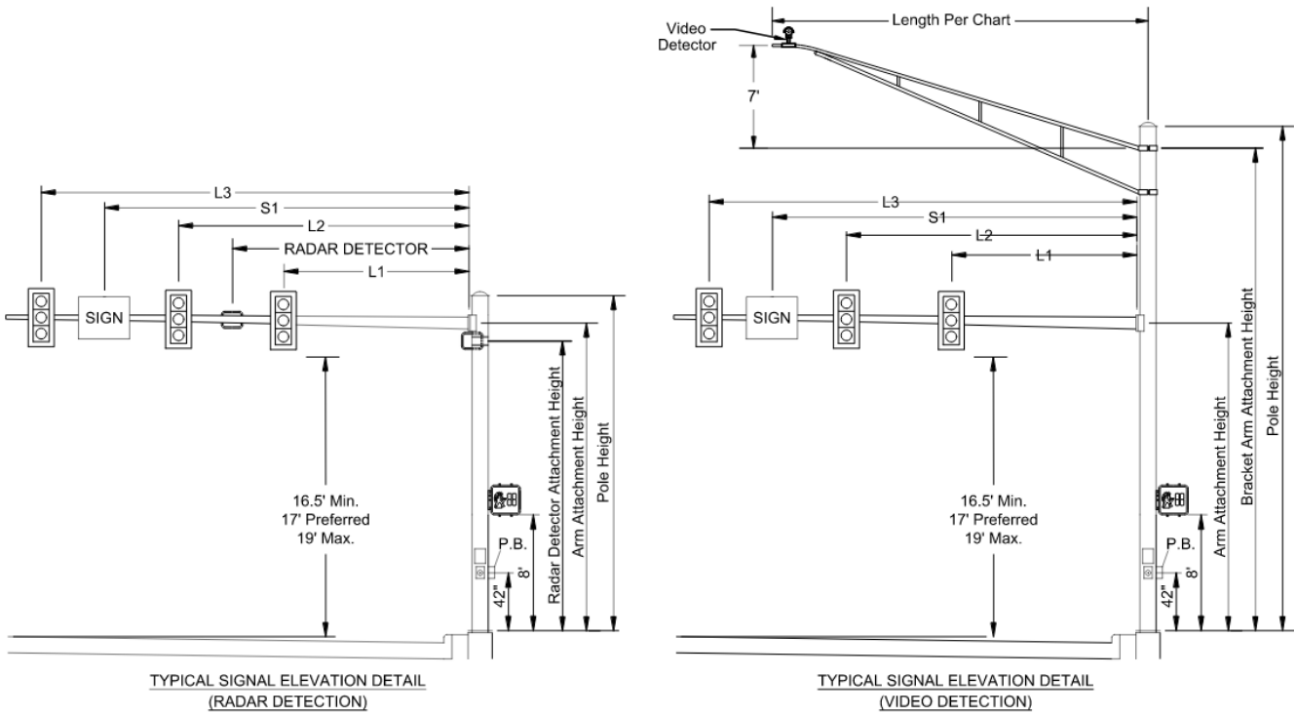

Figure 4.5
Typical Mast Arm Fabrication and Orientation Data Chart
(Radar Detection)

INTERSECTION	SHEET NO.	SUPPORT DESIGNATION	POLE COLOR/FEDERAL STANDARD 595B	POLE DESIGN NO.	POLE HT. (FT.)	MAST ARM LENGTH (FT.)	OBJECT ATTACH. HEIGHT		DISTANCE FROM BUTT PLATE (FT.)			POLE FABRICATION ANGLES CLOCKWISE FROM INDEX LINE (MAST ARM OR PEDESTAL HANDHOLE)				FIELD ORIENTATION			
							MAST ARM (FT.)	RADAR DETECTOR (FT.)	L1	L2	L3	RADAR DETECTOR	ANCHOR BOLT REFERENCE LINE	PED. SIGNALS	PED. PUSH BUTTON	HANDHOLE	INDEX LINE ANGLE	ANCHOR BOLT REF. LINE	FOUNDATION ELEVATION *
		S/E-1		4	21	32	19.5	18	12.5	23.5	-	-	90°	264°	255°	180°	0°	90°	723.87
ROAD NAME @	##	S/E-2		Pedestal	10.7	-	-	-	-	-	-	-	90°	344°	-	0°	18°	108°	723.61
ROAD NAME		S/W-1		4	21	32.5	19.5	-	14	24	-	20	90°	264°	-	180°	90°	0°	723.62
		S/W-2	SEMI-GLOSS	Pedestal	10.7	-	-	-	-	-	-	-	90°	347°	0°	0°	106°	16°	724.24
		N/W-1	BLACK #27038	4	21	32.5	19.5	18	13	24	-	-	90°	264°	257°	180°	0°	90°	724.55
		N/W-2		Pedestal	10.7	-	-	-	-	-	-	-	90°	355°	-	0°	15°	105°	724.73
		N/E-1		14	21	50.5	19.5	18	32	42	37	-	90°	8°	5°	180°	0°	90°	723.88
		N/E-2		Pedestal	10.7	-	-	-	-	-	-	-	90°	285°	-	0°	75°	165°	724.37

* The designer may list a "See Sheet #" in this column containing the sheet # of the detailed elevations on the Intersection Detail and/or Curb Ramp Detail Sheets.

Figure 4.6
Typical Mast Arm Fabrication and Orientation Data Chart
(Video Detection)

INTERSECTION	SHEET NO.	SUPPORT DESIGNATION	POLE COLOR/ FEDERAL STANDARD 595B	POLE DESIGN NO.	POLE HT. (FT.)	ARM LENGTH (FT.)		OBJECT ATTACH. HEIGHT (FT.)		DISTANCE FROM BUTT PLATE (FT.)			POLE FABRICATION ANGLES CLOCKWISE FROM INDEX LINE (MAST ARM OR PEDESTAL HANDHOLE)						FIELD ORIENTATION	
						MAST ARM	VIDEO BRACKET ARM	MASTARM	VIDEO BRACKET ARM	L1	L2	S1	ANCHOR BOLT REFERENCE LINE	PED. SIGNALS	PED. PUSH BUTTON	VIDEO BRACKET ARM	HANDHOLE	INDEX LINE ANGLE	ANCHOR BOLT REF. LINE	FOUNDATION ELEVATION *
		S/E-1		4	27	32	25	19.5	26	12.5	23.5	-	90°	264°	255°	0°	180°	0°	90°	723.87
ROAD NAME @	##	S/E-2		Pedestal	10.7	-	-	-	-	-	-	-	90°	344°	-	-	0°	18°	108°	723.61
ROAD NAME		S/W-1		4	27	32.5	25	19.5	26	14	24	-	90°	264°	-	0°	180°	90°	0°	723.62
		S/W-2	SEMI-GLOSS BLACK	Pedestal	10.7	-	-	-	-	-	-	-	90°	347°	0°	-	0°	106°	16°	724.24
		N/W-1	#27038	4	27	32.5	25	19.5	26	13	24	-	90°	264°	257°	0°	180°	0°	90°	724.55
		N/W-2		Pedestal	10.7	-	-	-	-	-	-	-	90°	355°	-	-	0°	15°	105°	724.73
		N/E-1		14	27	50.5	30	19.5	26	32	42	37	90°	8°	5°	0°	180°	0°	90°	723.88
		N/E-2		Pedestal	10.7	-	-	-	-	-	-	-	90°	285°	-	-	0°	75°	165°	724.37

* The designer may list a "See Sheet #" in this column containing the sheet # of the detailed elevations on the Intersection Detail and/or Curb Ramp Detail Sheets.

Figure 4.7
Typical Strain Pole and Pedestal Fabrication and Orientation Data

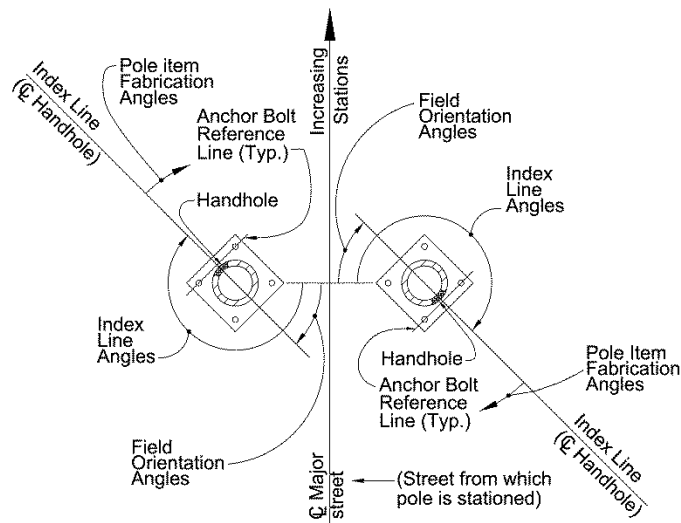

NOTES:

- All angles measured clockwise.
- Index line goes through the center of the handhole.

TYPICAL STRAIN POLE AND PEDESTAL ORIENTATION DETAIL
 NOT TO SCALE

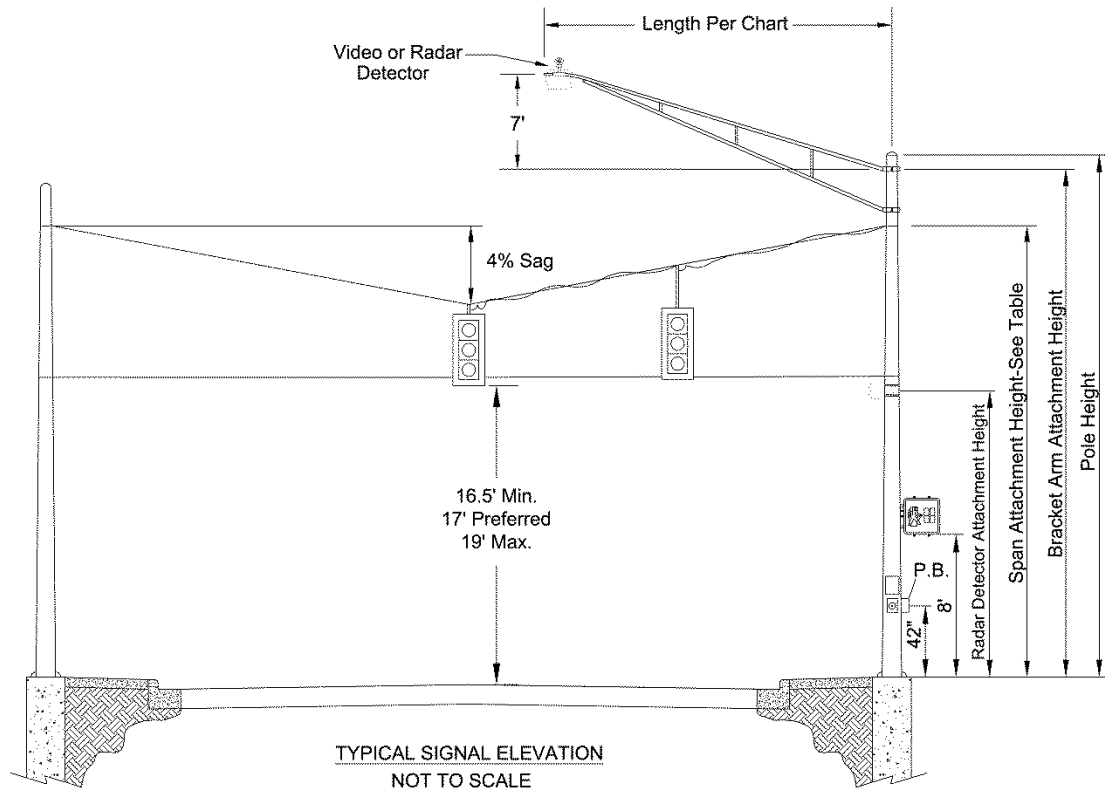

TYPICAL SIGNAL ELEVATION
 NOT TO SCALE

Figure 4.8
Typical Strain Pole Fabrication and Orientation Data Chart

INTERSECTION	SHEET NO.	POLE SIZES & ATTACHMENT HEIGHTS						DETECTION BRACKET ARM				POLE FABRICATION DATA CLOCKWISE FROM HANDHOLE AT 0 DEGREES					FIELD ORIENTATION		
		POLE DESIGNATION	POLE COLOR/ FEDERAL STANDARD 595B	POLE DESIGN NO.	POLE HT. (FT.)	SPAN ATTACHMENT HT. (FT.)	RADAR DETECTOR (FT.)	ATTACHMENT HEIGHT	BRACKET ARM LENGTH	ANCHOR BOLT REF. LINE	2" BHC ANGLE-HT. DEG.-FT.	3" BHC ANGLE-HT. DEG.-FT.	PD SIGNALS	PD BUTTON	INDEX LINE ANGLE (HANDHOLE)	ANCHOR BOLT REF. LINE	CAPPED FOUND. CONDUIT ELL 2" DIA.	FOUNDATION * ELEVATION	
		S/E-1		8	32'	28.5'	-	31'	25'	90°	-	-	-	225°	135°	-	726.09		
		S/E-2		PEDESTAL	10.7'	-	-	-	-	90°	-	203°	180°	148°	58°	-	726.09		
		S/E-3		PEDESTAL	10.7'	-	-	-	-	90°	-	262°	-	198°	108°	-	725.95		
ROAD NAME AT	##	N/E-1		8	31'	27'	-	30'	30'	90°	180° - 28'	223°	251°	134°	44°	134°	725.45		
ROAD NAME		NW-1	SEMI-GLOSS BLACK #27038	8	32'	28.5'	-	31'	25'	90°	180° - 29.5'	-	-	224°	134°	-	729.12		
		NW-2		PEDESTAL	10.7'	-	-	-	-	90°	-	105°	90°	242°	152°	-	728.11		
		NW-3		PEDESTAL	10.7'	-	-	-	-	90°	-	240°	-	217°	127°	-	728.66		
		SW-1		EXISTING	EX.	26'	-	-	-	EX.	EX.	130°/226°	-	135°	EX.	-	728.99		
		SW-2		PEDESTAL	5'	-	-	-	-	90°	-	-	180°	203°	113°	-	727.53		

* The designer may list a "See Sheet #" in this column containing the sheet # of the detailed elevations on the Intersection Detail and/or Curb Ramp Detail Sheets.

CHAPTER 5: VEHICULAR SIGNALS

5.1 Vehicular Signal Head Specifications

5.1.1 Material Specifications

Traffic Signal Heads shall be furnished in accordance with Sections 632 and 732 of the current version of the [City of Columbus Construction and Material Specifications](#).

Materials shall also be in accordance with the City of Columbus [Qualified Products List](#).

5.1.2 Vehicular Signal Head Lens Size

Per the requirement of the [Ohio Manual of Uniform Traffic Control Devices](#), 12 in. diameter lenses shall be used in all locations except as noted in section 4D.07 and with prior approval and direction of the City of Columbus, City Engineer or appointed designee.

All arrow indications shall be 12 in. When a signal head configuration contains arrow indications, at a minimum, all signal heads on that approach shall be 12 in.

The 4-section head (R-Y-G, G-arrow) shall be an inverted-T configuration for split phase operation and a stacked configuration for lagging left turns.

5.1.3 Vehicular Signal Head Backplates

Louvered aluminum backplates shall be used with all newly installed traffic signal heads as per [City of Columbus Standard Construction Drawing 4205](#). Signal heads with backplates shall be rigidly mounted to the mast arm or secured with a bottom tether on span wire installations.

Figure 5.1
Vehicular Traffic Signal Head Configuration

8" LED SIGNAL HEADS WITH BACKPLATES

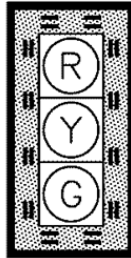

12" LED SIGNAL HEADS WITH BACKPLATES

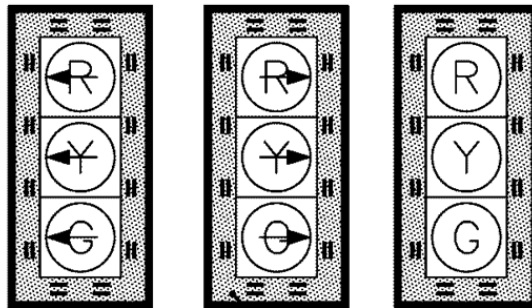

BACKPLATE (TYP.)

REFLECTIVE MATERIAL (TYP.)

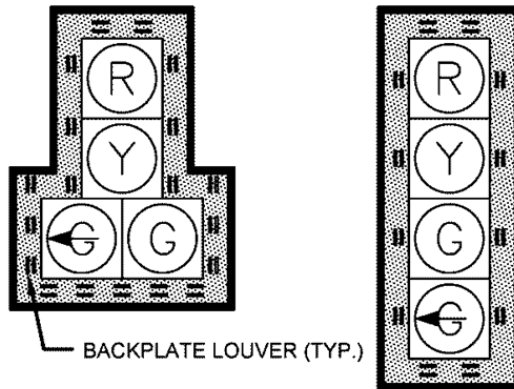

BACKPLATE LOUVER (TYP.)

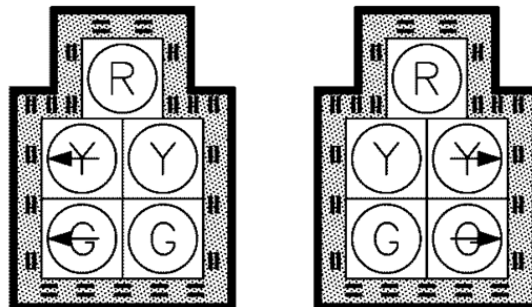

5.1.4 Signal Head Mounting

Rigid mounted signal heads shall be used with all newly constructed mast arm traffic signals as per [City of Columbus Standard Construction Drawing 4201](#).

When span wire supports are used, a bottom tether shall be specified per [City of Columbus Standard Construction Drawing 4202](#).

5.1.5 Signal Head Color

The color of signal heads installed in the City of Columbus shall be per the [City of Columbus Construction and Material Specifications](#) (except in specific situations listed in this section).

5.1.5.1 Special Signal Head Color

In designated special districts, signal heads may have the back of the housing a color other than as specified in the [City of Columbus Construction and Material Specifications](#); the area and color shall be subject to advanced approval by the City of Columbus, City Engineer or appointed designee. These specially colored heads will be supplied (for initial installation and for maintenance) by the Sponsor, “governing authority” of the special district pursuant to a written installation and maintenance agreement. Colors shall be coordinated with the requirements of **Section 6.1.4.1**.

5.2 Vehicular Signal Head Application

5.2.1 Number of Signal Heads

The total number of heads will depend on the number of approach lanes and shall be in conformance with Section 4D.11 of the [Ohio Manual of Uniform Traffic Control Devices](#).

Signal heads shall be provided as near as practical to the line of the driver’s normal view. Additional heads may be required for approach visibility for skewed/curved geometrics per the [Ohio Manual of Uniform Traffic Control Devices](#) Section 4D.13 and 4D.14.

In addition to the application of primary signal heads as discussed above, supplemental signal heads shall be required when the minimum visibility, distance from the stop line and/or alignment cannot be achieved as outlined herein.

5.2.2 Distance from Stop Line to Signal Head

Signal head to stop line distances shall be in conformance with the requirements established in Section 4D.14 of the [Ohio Manual of Uniform Traffic Control Devices](#).

5.2.3 Signal Head Mounting Height

The vertical clearance for vehicular signal heads mounted over the roadway shall be measured from the pavement surface to the bottom of the signal housing/backplate:

- Minimum clearance = 16.5 ft.
- Preferred clearance= 17 ft.
- Maximum clearance = 19 ft.

The vertical clearance for vehicular signal heads not mounted over a roadway or driveway shall be measured from the ground surface to the bottom of the signal housing/backplate. For this application, an 8 ft. minimum vertical clearance is permissible, but the design should attempt to adhere to vertical clearance requirements for heads mounted over the roadway.

Mounting height shall be based on mounting the far left signal head so the mast arm is centered on the amber section. The bottom of all other vehicular signal heads mounted on the arm should be vertically aligned with the bottom of the far left head.

Table 5.1 summarizes signal head location guidelines.

5.2.4 Vehicular Signal Head Alignment

Head placement shall be detailed on the signal plan with the use of a span diagram for span wire installations or a pole fabrication chart for mast arm applications. These diagrams/charts are to be as accurate as practicable, round placement values to the nearest tenth of a foot. Values are to reflect the horizontal distance along the span or mast arm. Span wire or mast arm mounted signs and other miscellaneous devices shall also be detailed on the diagram/chart.

The signal faces/heads for any approach shall not be less than 8 ft. apart, 10 ft. is the preferred minimum, measured horizontally between centers of faces/ heads.

Vehicular signal head placements for 3 section (R-Y-G), 4 section (R-Y-G-G arrow) and 5 section heads with left or right turn arrows shall be on an

aligned extension of a channelizing line, lane line or the middle of the traveled lane depending on the number of approach lanes and their configuration.

Field conditions may restrict the ability to place signal heads within these guidelines. The designer is required to consider: roadway intersection angle, approach widths, ramp locations, crosswalk layout, intersection radii and underground/overhead utilities.

The signal face shall be perpendicular to the direction of travel. Supplemental signal heads shall be orientated to provide the maximum visibility for approaching traffic.

Table 5.1 Vehicular Signal Head Location Guidelines

	Minimum ft.	Preferred ft.	Maximum ft.
Spacing between adjacent heads	8	10 to 12	N.A.
Clearance above roadway	16.5	17	19
Distance from Stop Line	40	75 to 130	180*

* 180 ft. is the preferred maximum. If the width of an intersecting roadway or other conditions makes it physically impractical to place the heads within 180 ft., supplemental signal heads shall be installed. See Section 4D.14 of the [Ohio Manual of Uniform Traffic Control Devices](#).

5.2.4.1 Vehicular Signal Head Alignment - Through Lanes

General vehicular signal head placement guidelines are outlined in **Figures 5.2** through **5.36**. These figures represent general conditions, all head placement shall be in conformance with the requirements published in the [Ohio Manual of Uniform Traffic Control Devices](#).

5.2.4.2 Vehicular Signal Head Alignment - Turn Lanes

Arrows shall be used for protected only movements not in conflict with any other signal indication including walk signals. Flashing yellow arrows shall not be used.

General vehicular signal head placement guidelines (R-arrow, Y-arrow & G-arrow) for protected only left or right turn movements should be as follows. These guidelines represent general conditions, all head placement shall be in conformance with the requirements published in the [Ohio Manual of Uniform Traffic Control Devices](#).

Single Left Turn Lane

The 3-section signal head shall be located on the lane centerline. When applied to 10 ft. lanes, the position may vary to maintain a minimum of 8 ft. head separation. An R10-5-30 sign shall not be used unless directed by the City. If used, the sign is to be placed 3 ft. to the right of the left turn signal head (measured center of head to center of sign).

Single Right Turn Lane

The signal head shall be located 1.5 ft. to the right of the lane centerline. An R10-5-30 (if arrows are used) or R10-10-30 (if solid red ball is used) sign shall be placed 1.5 ft. to the left of the lane centerline to achieve 3 ft. separation between the center of the sign and the center of the head. When applied to 10 ft. lanes, dimensions may vary to maintain a minimum of 8 ft. head separation.

Dual Left Turn Lanes

Head placement (R-arrow, Y-arrow & G-arrow) for a dual protected only left turn movement shall be on the lane centerlines.

Figure 5.2
Vehicular Signal Head Alignment
Single Approach Lane
Configuration A

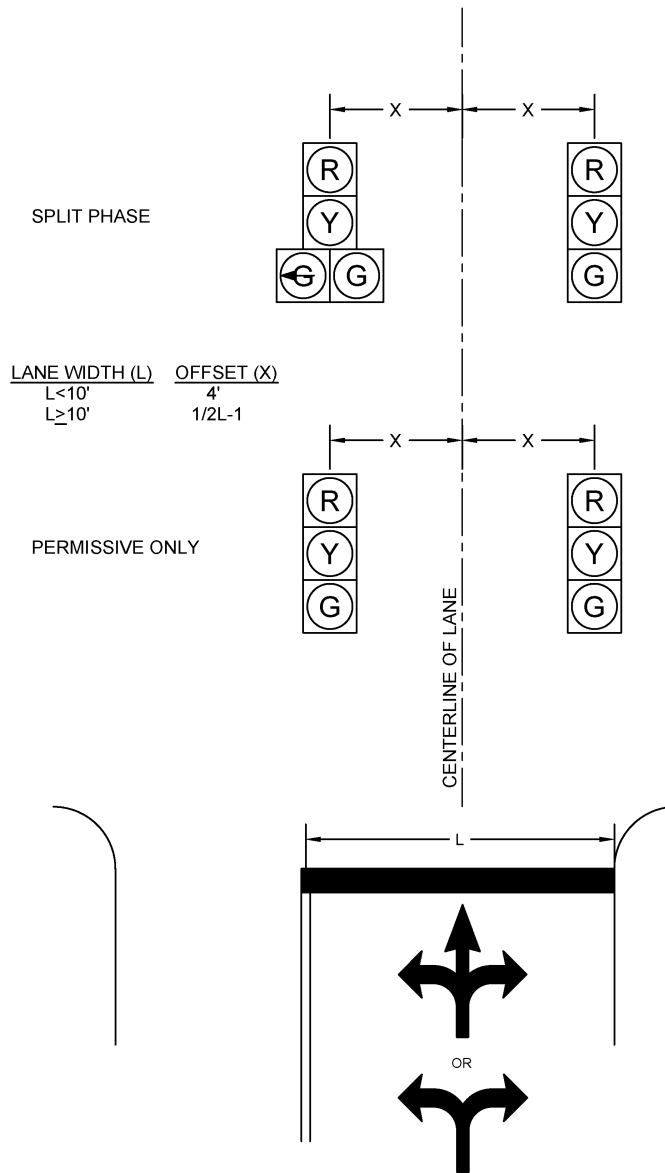

Figure 5.3
Vehicular Signal Head Alignment
Two Approach Lanes
Configuration A

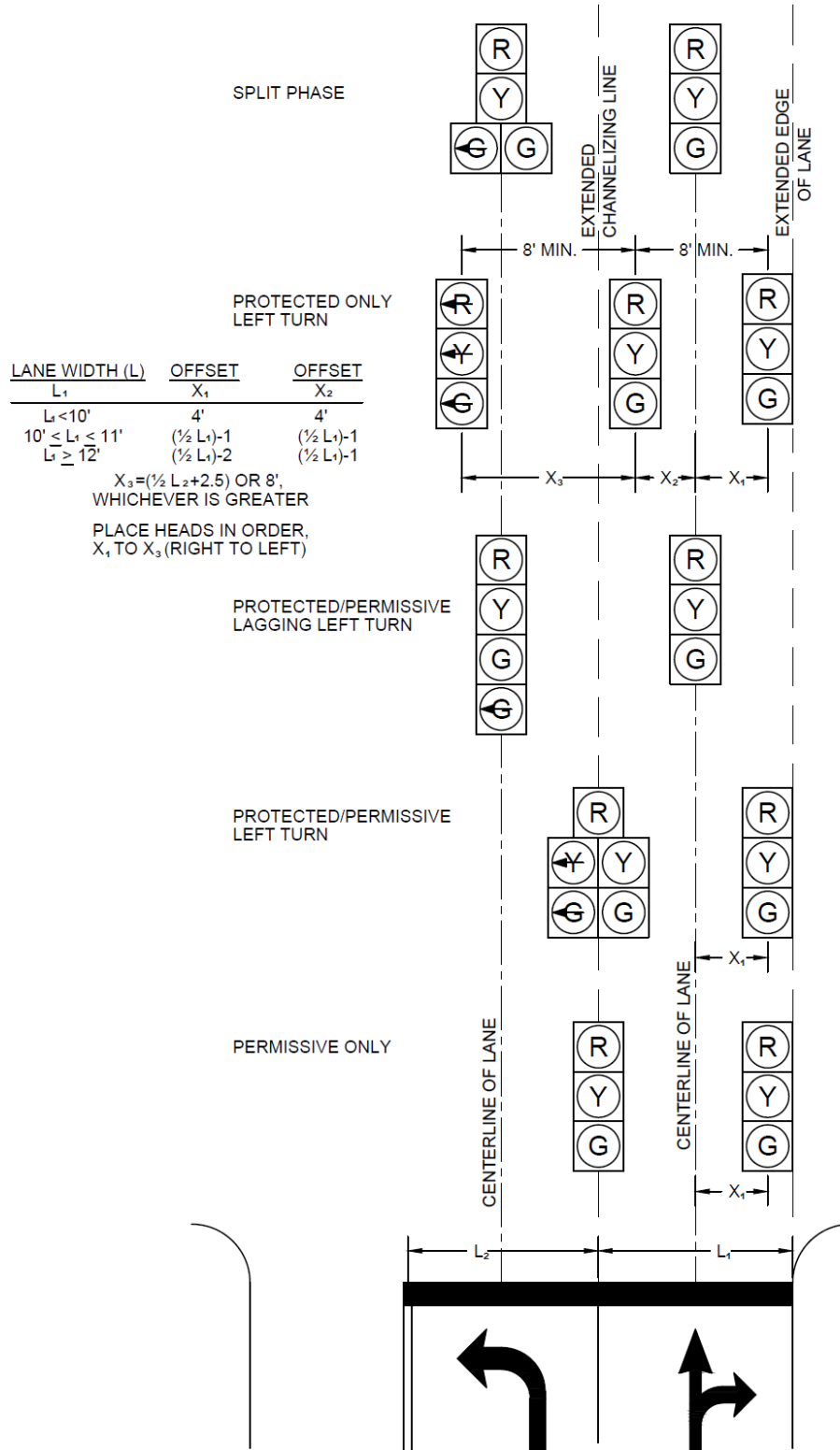

Figure 5.4
Vehicular Signal Head Alignment
Two Approach Lanes
Configuration B

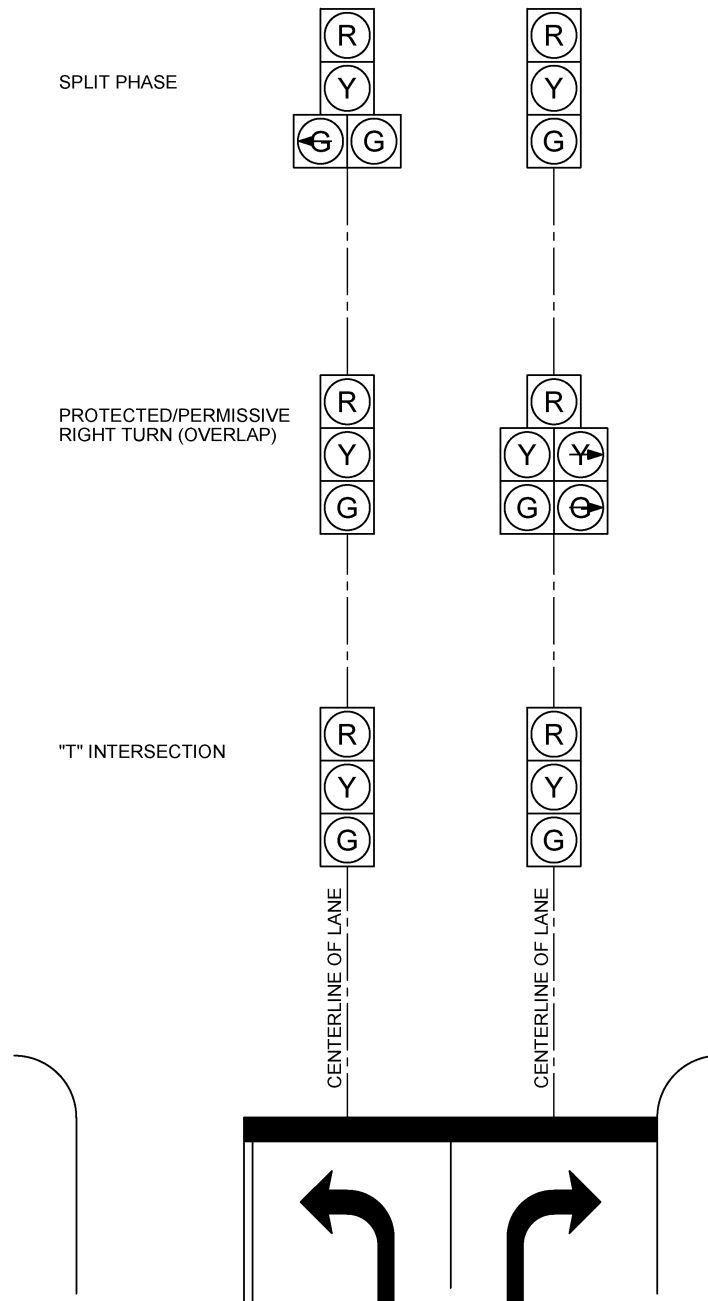

Figure 5.5
Vehicular Signal Head Alignment
Two Approach Lanes
Configuration C

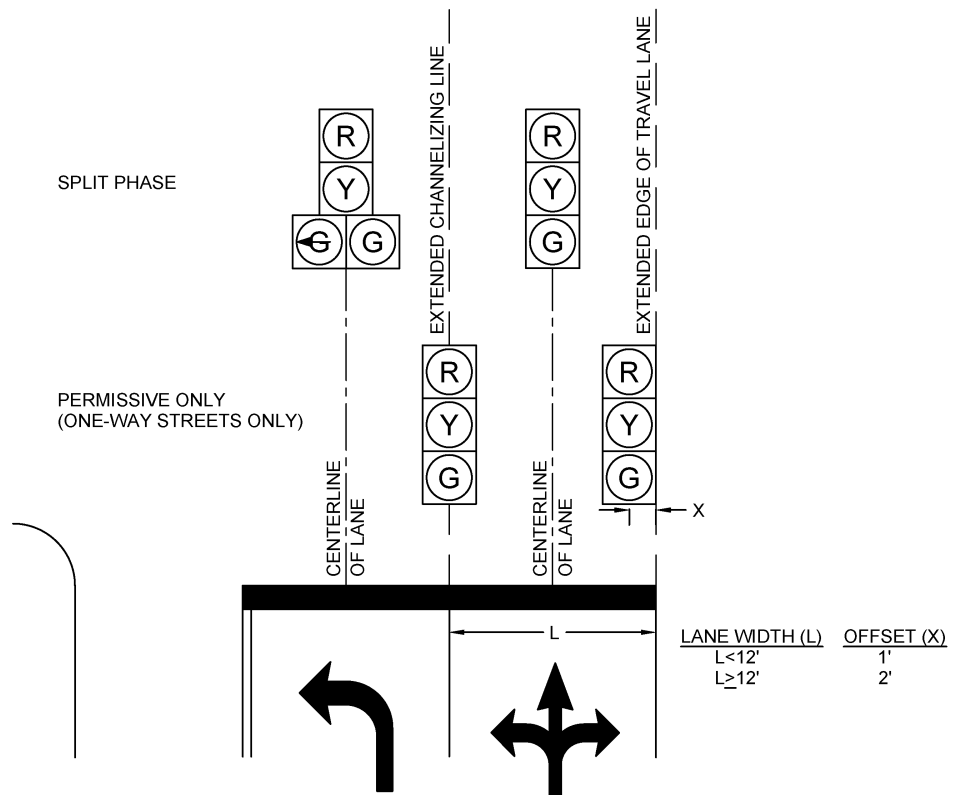

Figure 5.6
Vehicular Signal Head Alignment
Two Approach Lanes
Configuration D

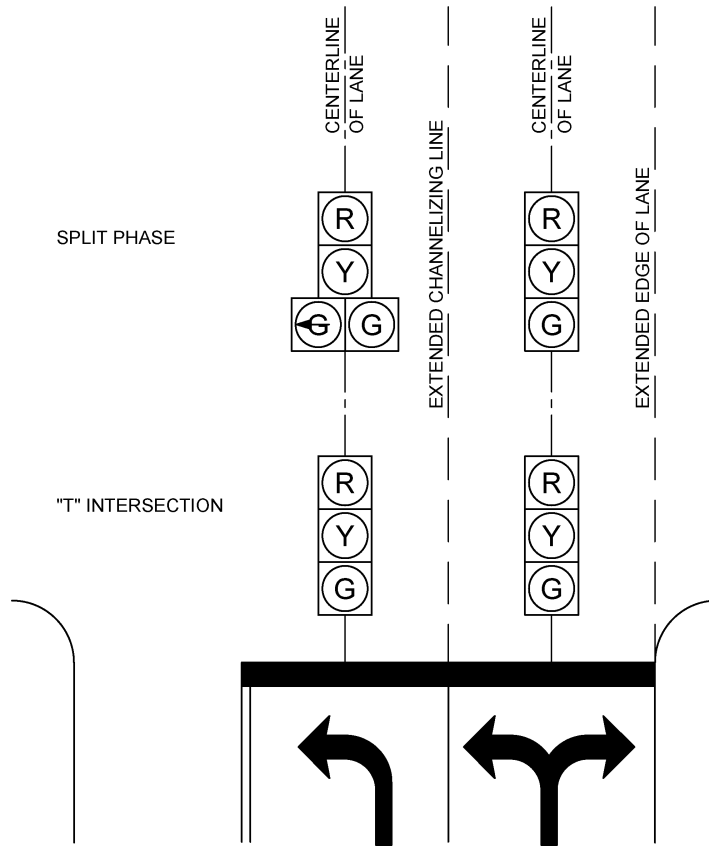

Figure 5.7
Vehicular Signal Head Alignment
Two Approach Lanes
Configuration E

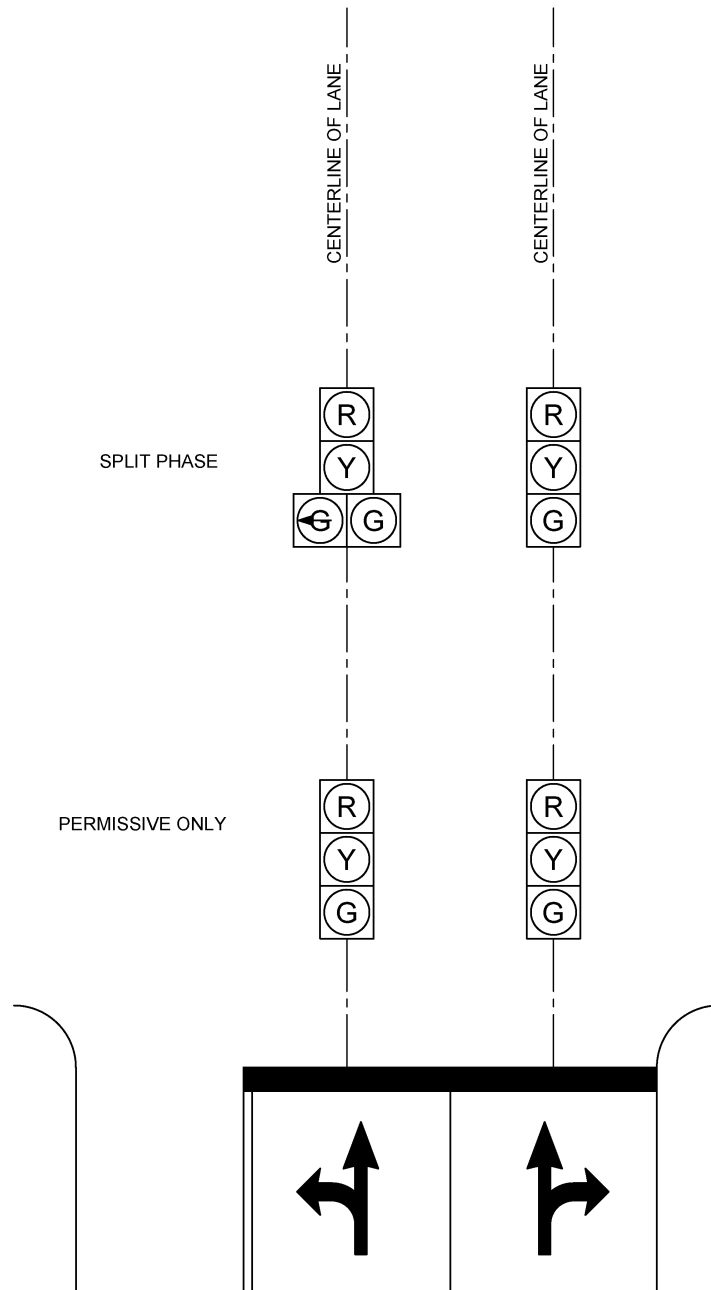

Figure 5.8
Vehicular Signal Head Alignment
Two Approach Lanes
Configuration F

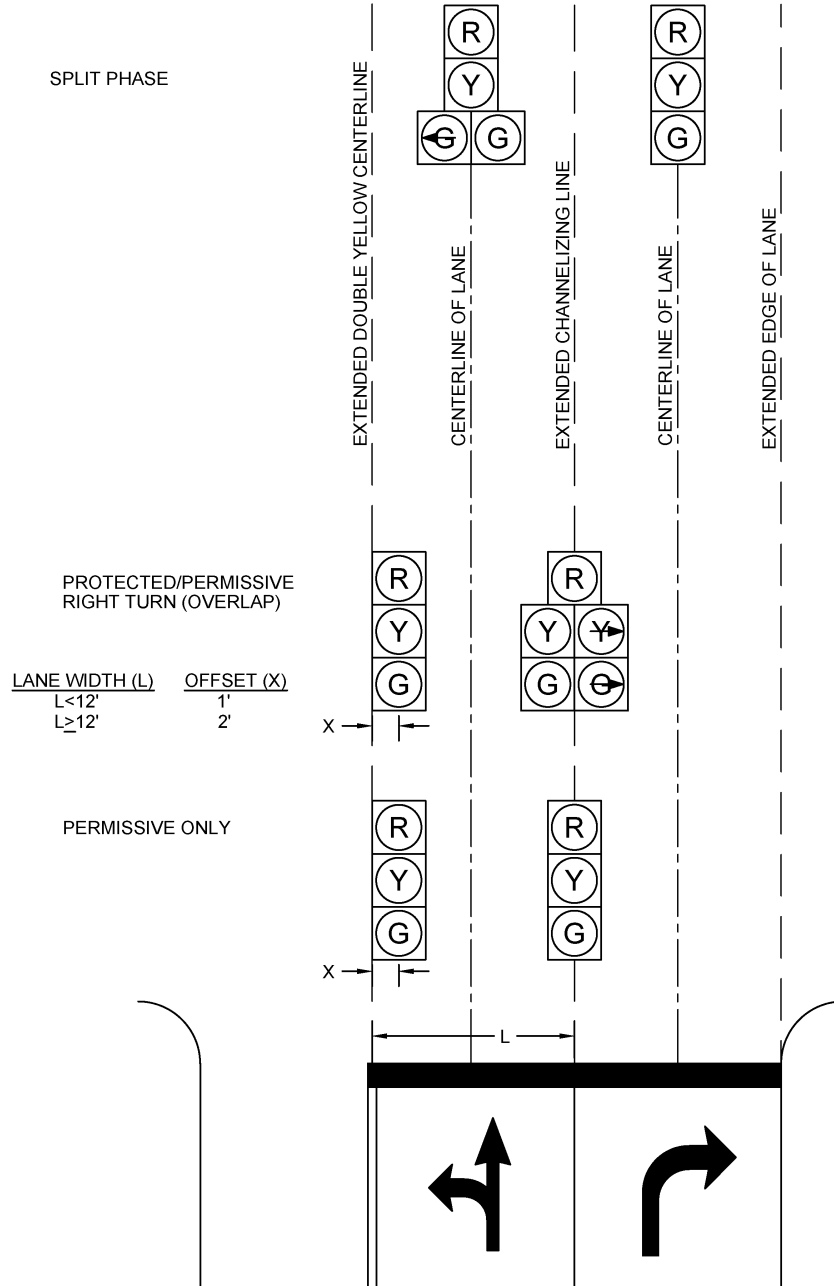

Figure 5.9
Vehicular Signal Head Alignment
Two Approach Lanes
Configuration G

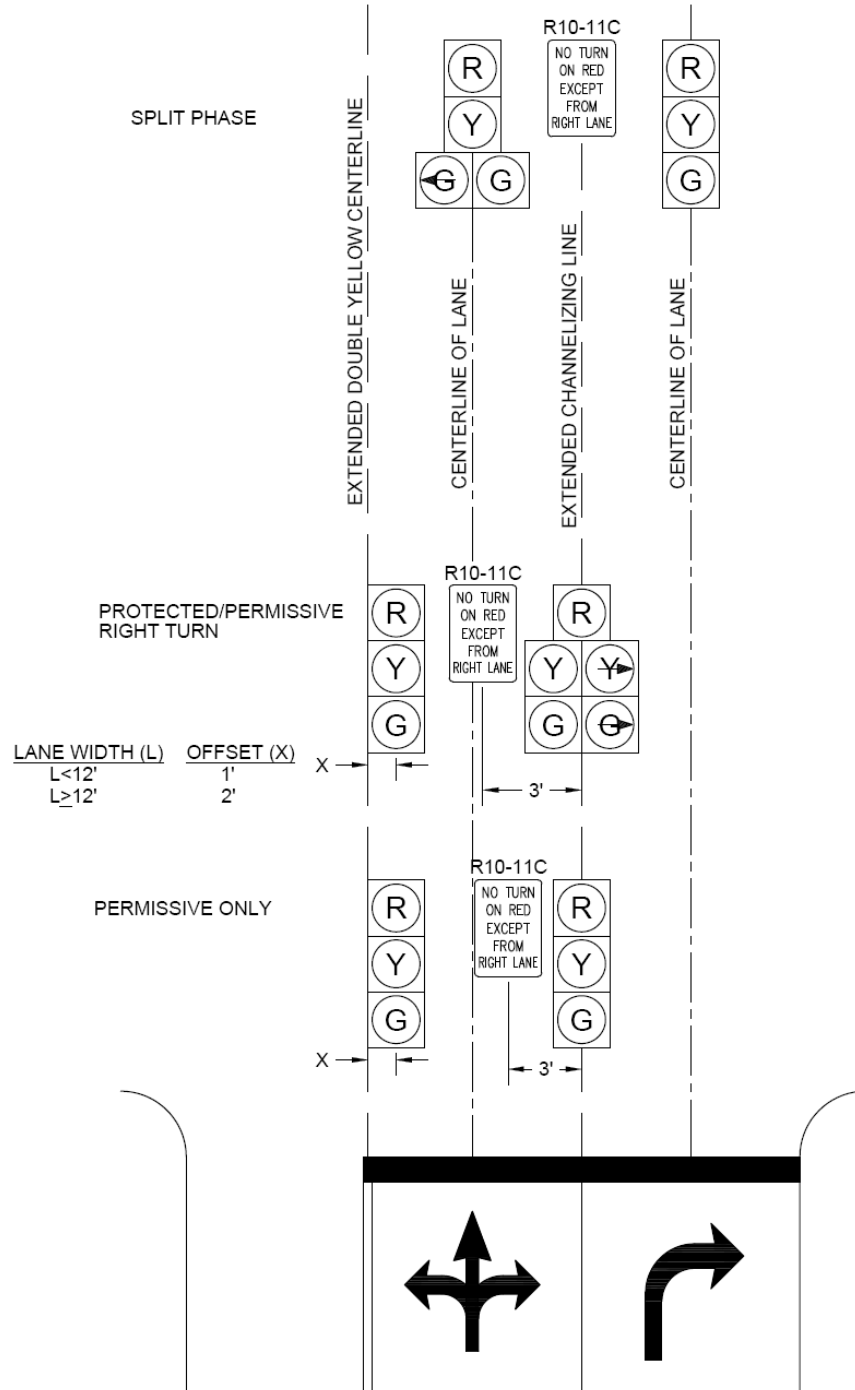

Figure 5.10
Vehicular Signal Head Alignment
Two Approach Lanes
Configuration H

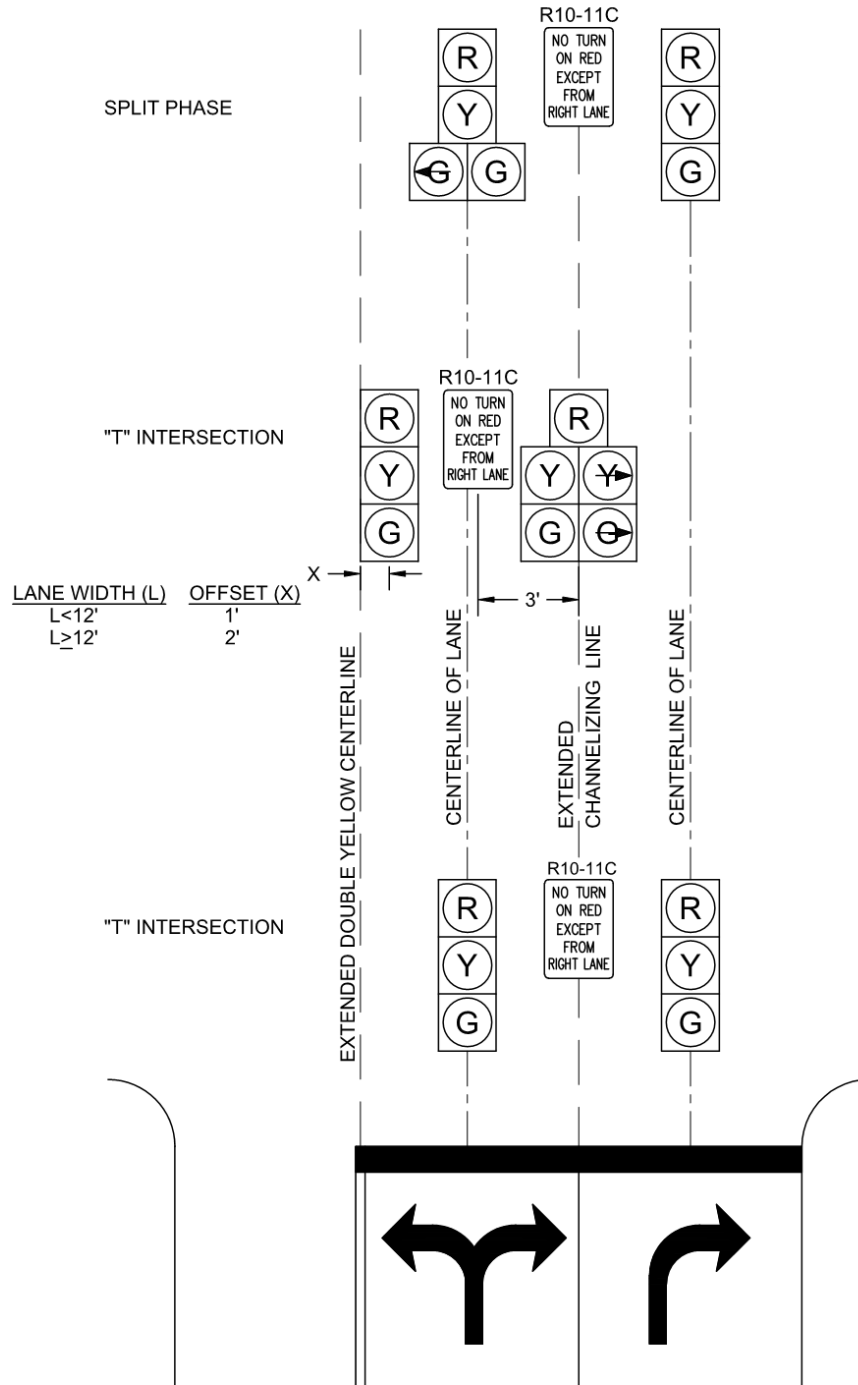

Figure 5.11
Vehicular Signal Head Alignment
Three Approach Lanes
Configuration A

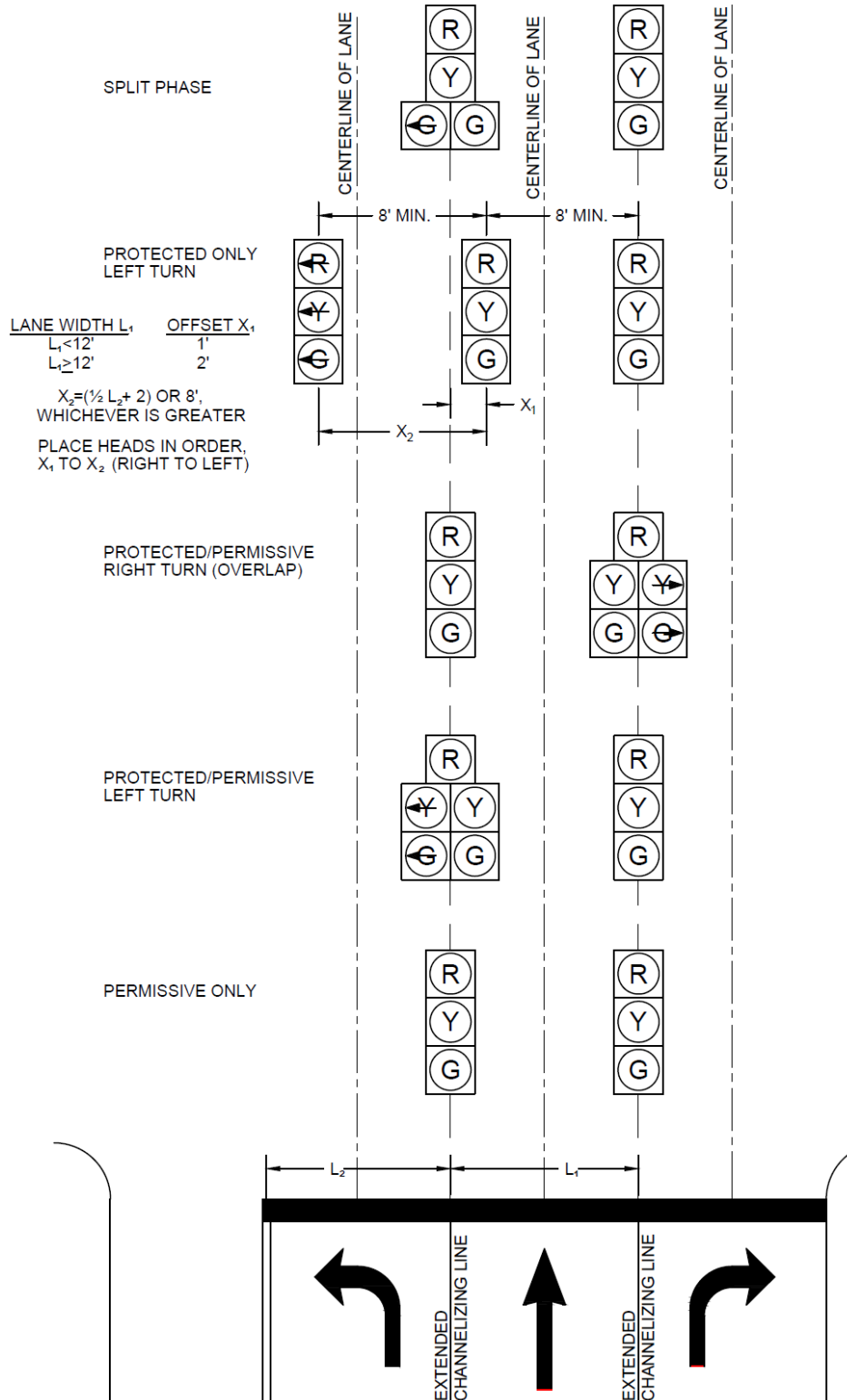

Figure 5.12
Vehicular Signal Head Alignment
Three Approach Lanes
Configuration B

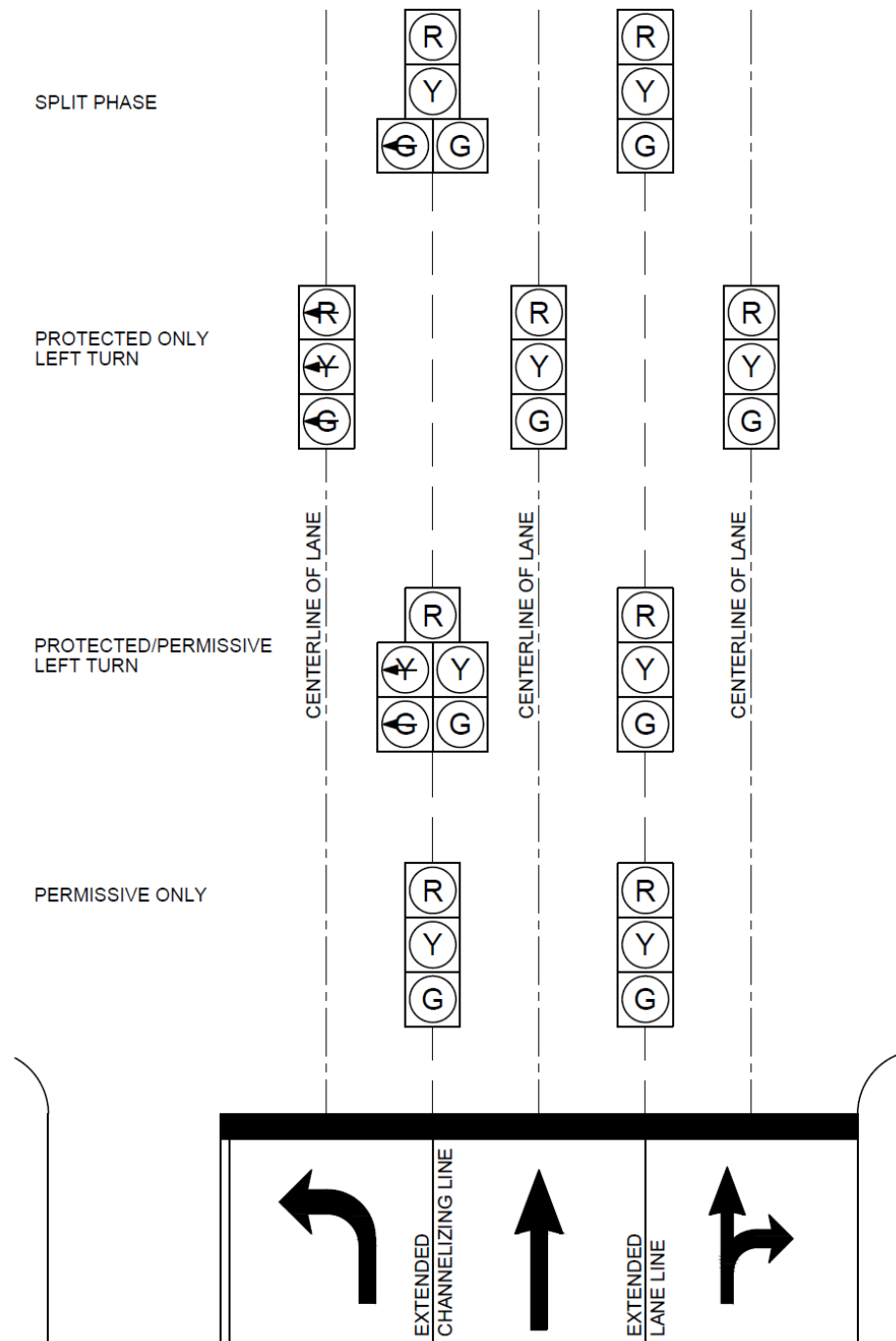

Figure 5.13
Vehicular Signal Head Alignment
Three Approach Lanes
Configuration C

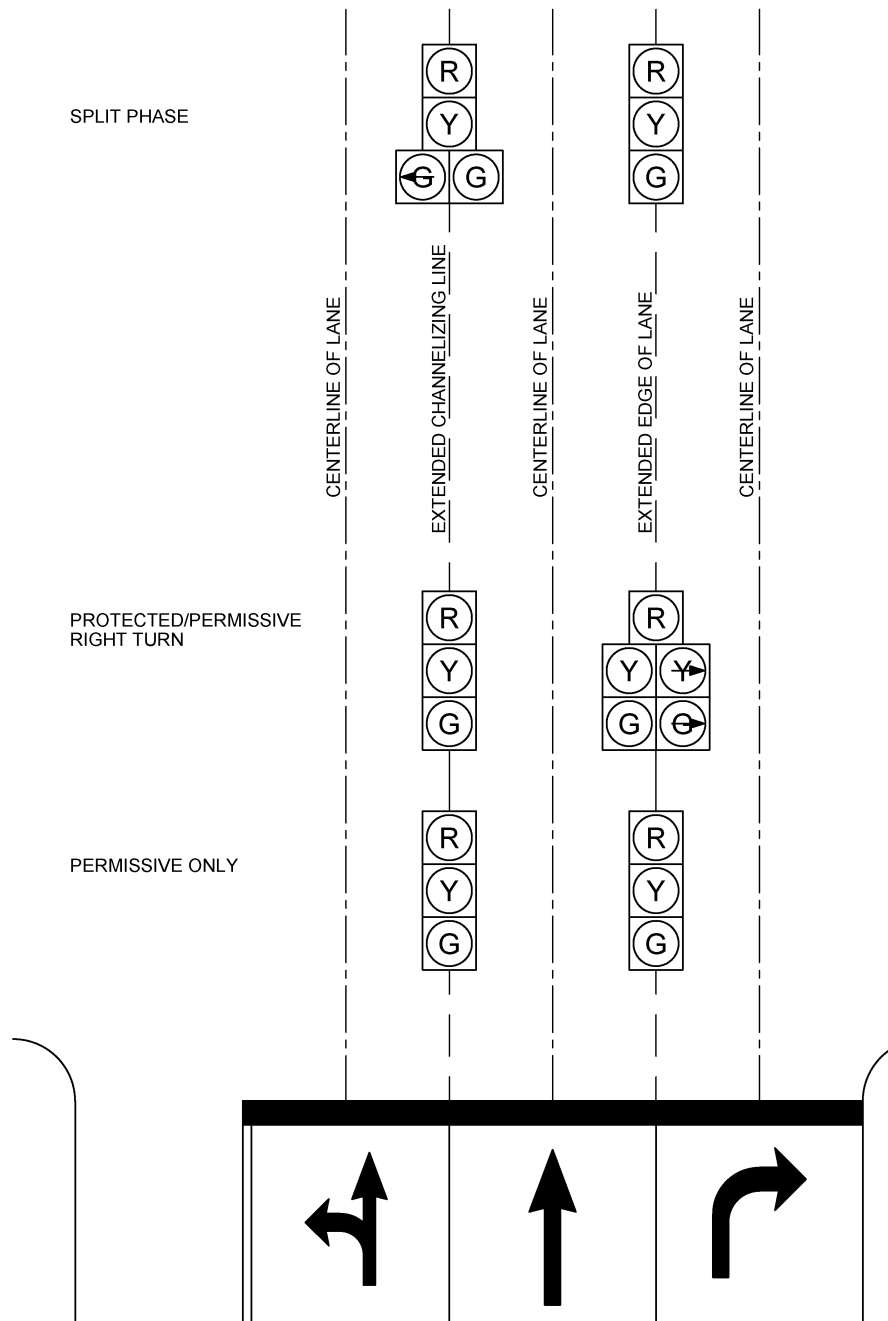

Figure 5.14
Vehicular Signal Head Alignment
Three Approach Lanes
Configuration D

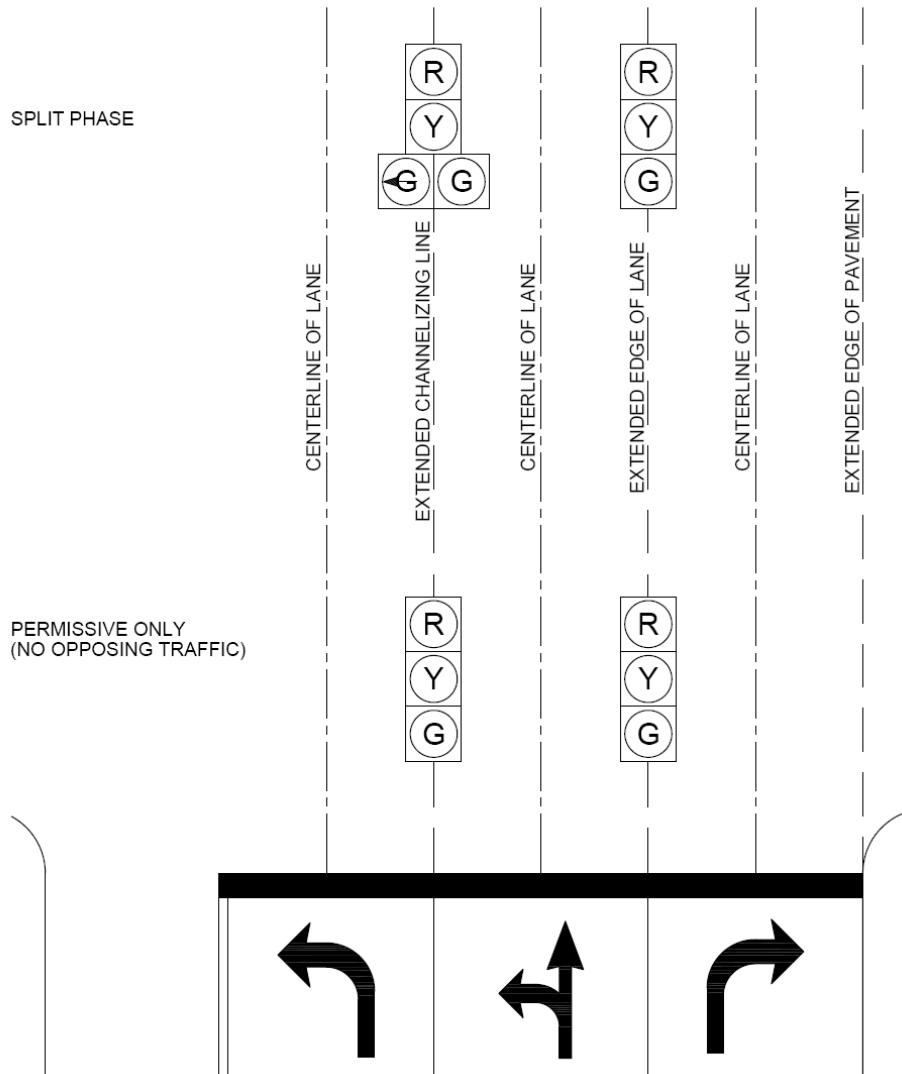

Figure 5.15
Vehicular Signal Head Alignment
Three Approach Lanes
Configuration E

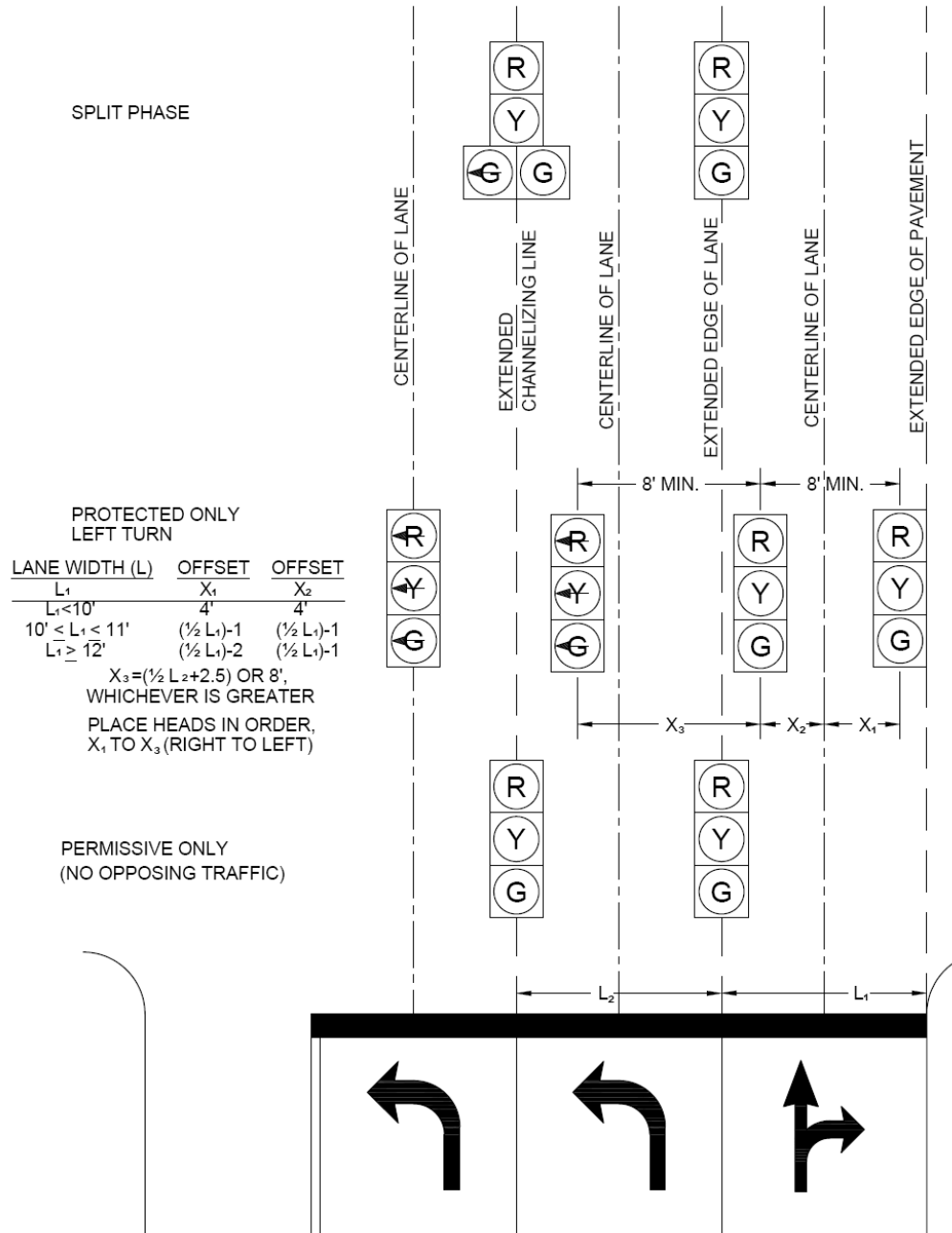

Figure 5.16
Vehicular Signal Head Alignment
Three Approach Lanes
Configuration F

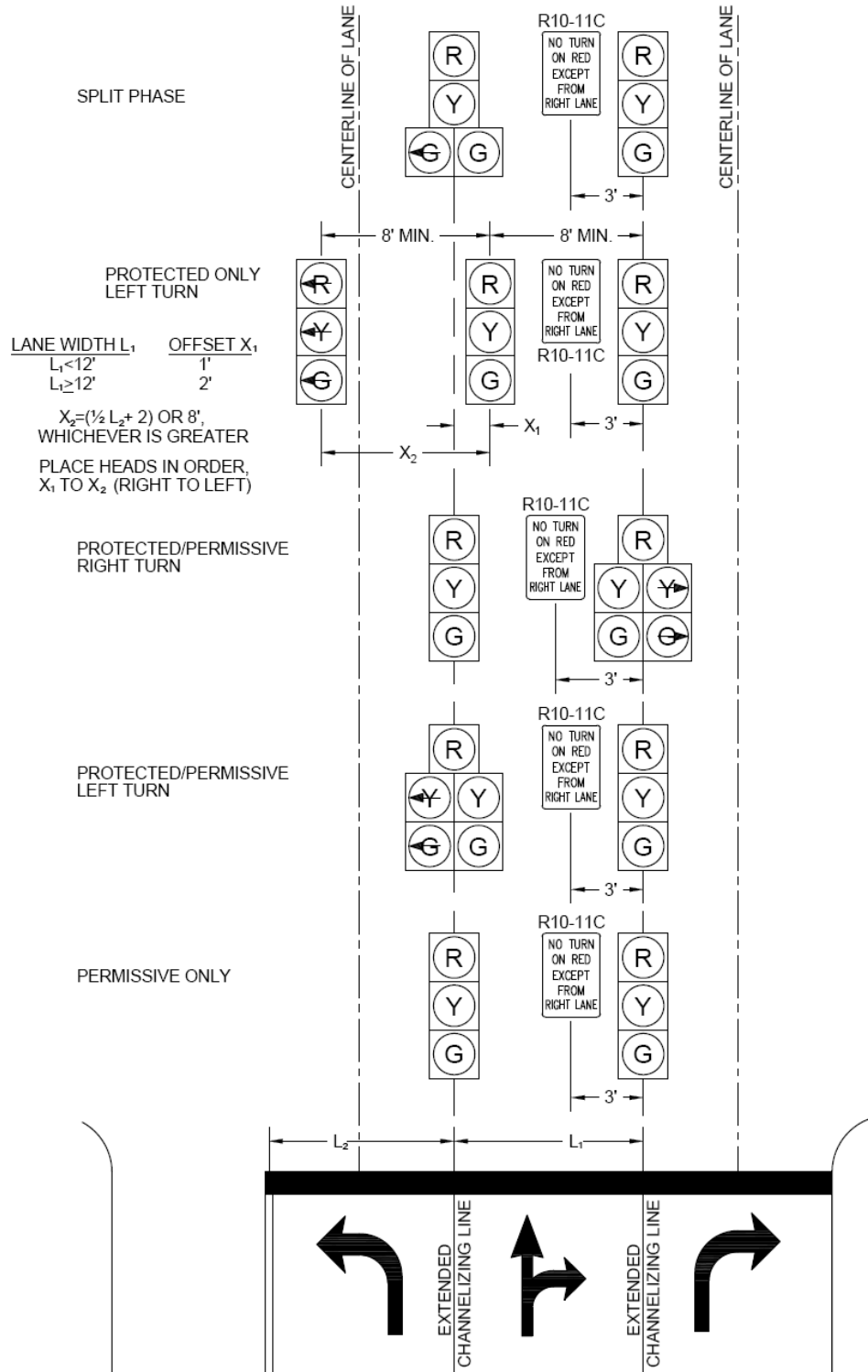

Figure 5.17
Vehicular Signal Head Alignment
Three Approach Lanes
Configuration G

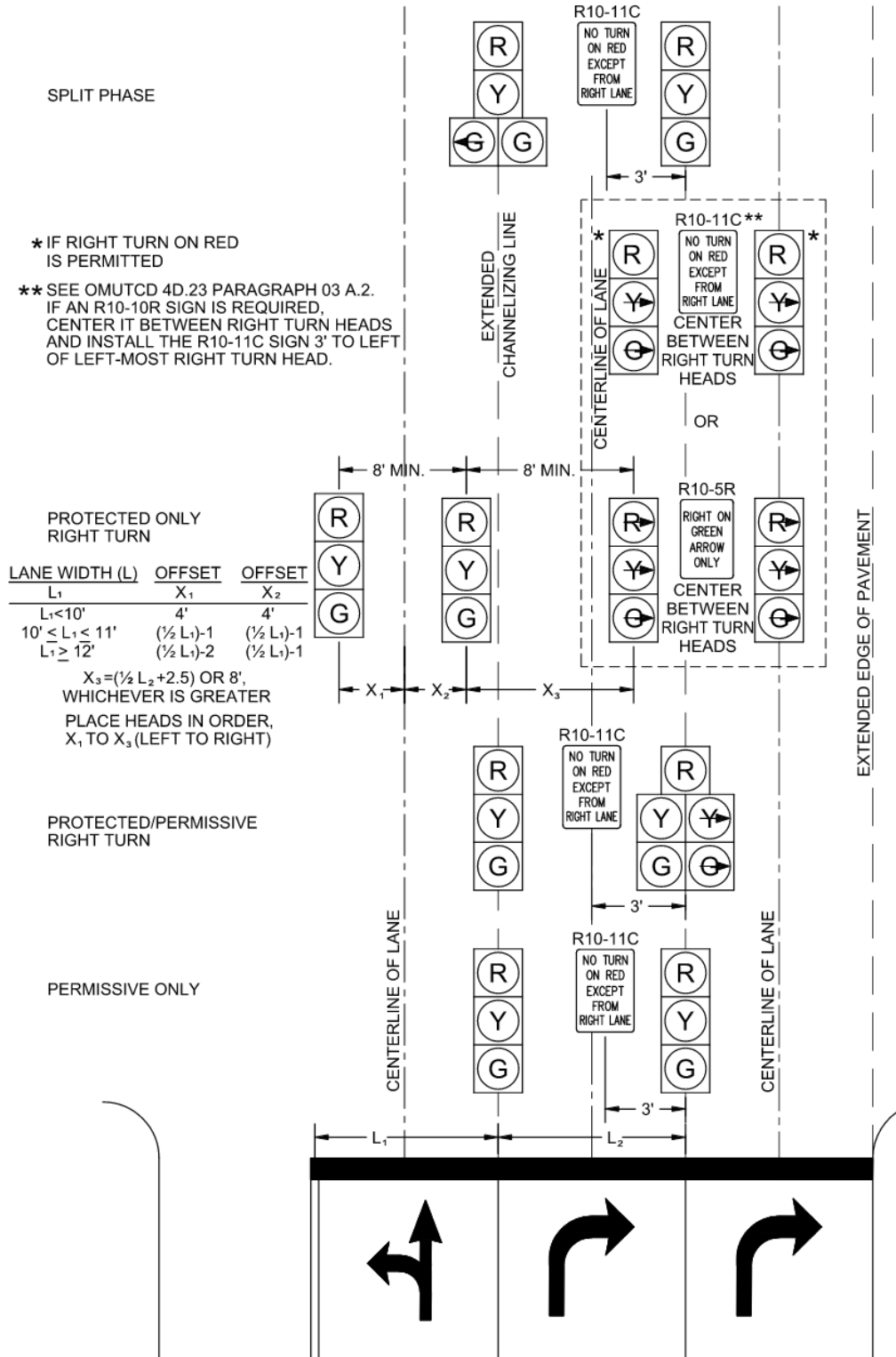

Figure 5.18
Vehicular Signal Head Alignment
Three Approach Lanes
Configuration H

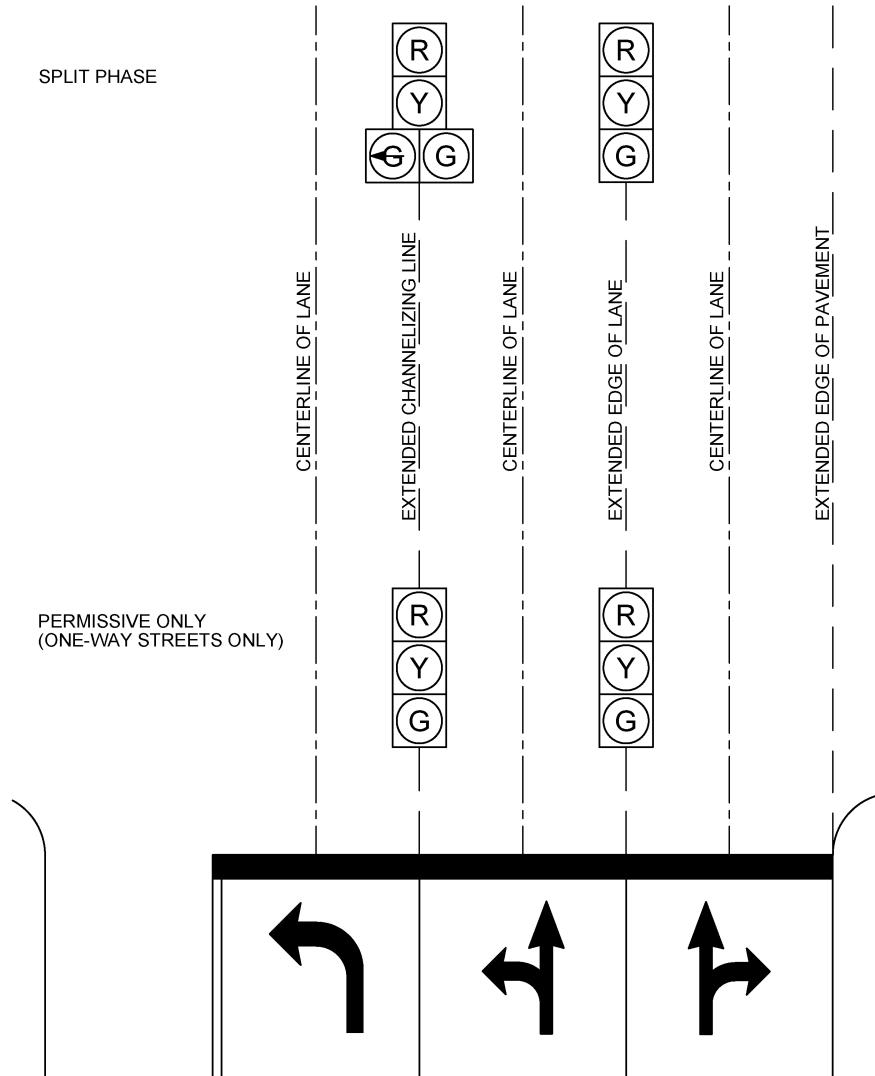

Figure 5.19
Vehicular Signal Head Alignment
Three Approach Lanes
Configuration I

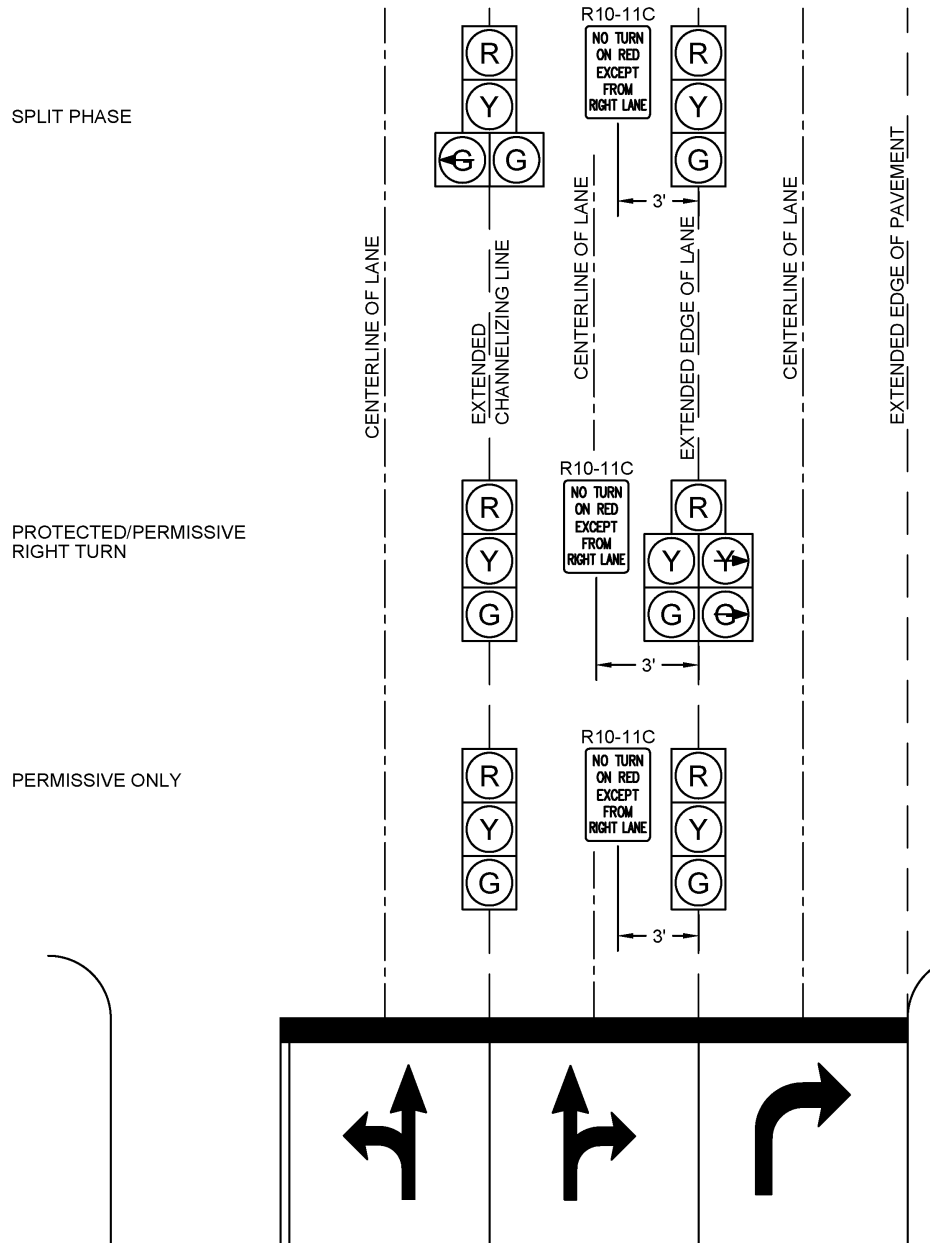

Figure 5.20
Vehicular Signal Head Alignment
Four Approach Lanes
Configuration A

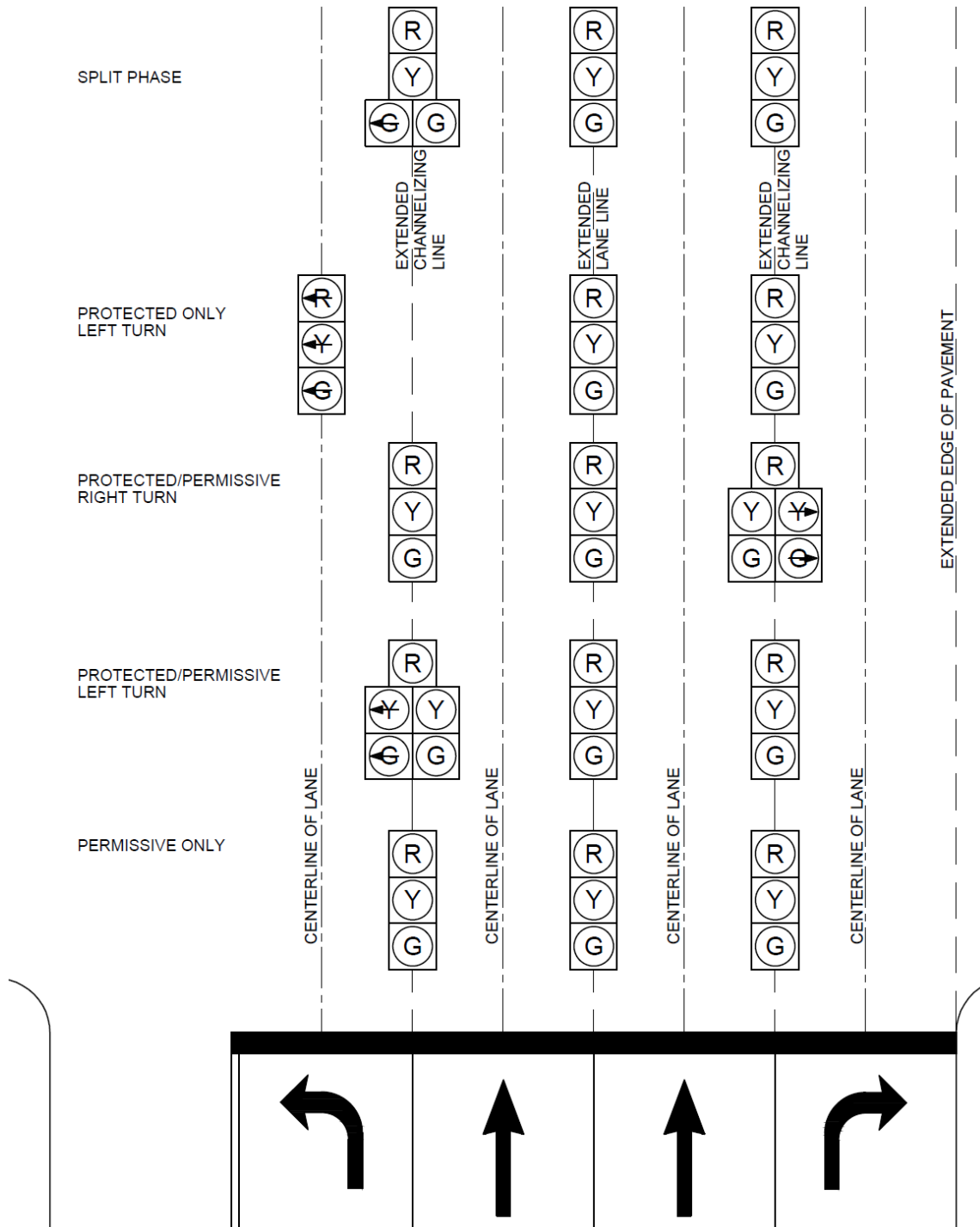
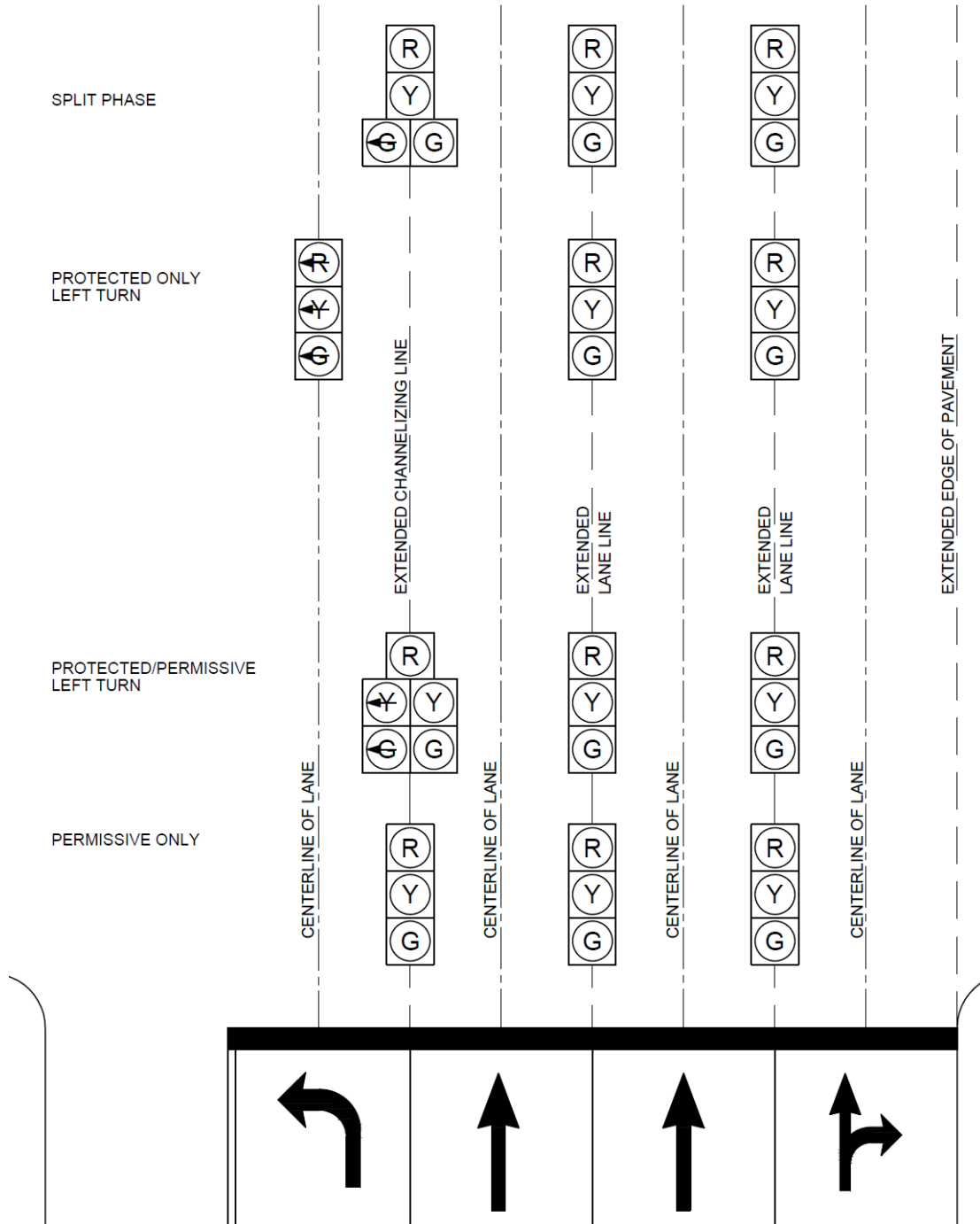

Figure 5.21
Vehicular Signal Head Alignment
Four Approach Lanes
Configuration B
 (Posted Speed < 45 MPH)*



* For posted speeds 45 MPH or higher, see OMUTCD Section 4D.11

Figure 5.22
Vehicular Signal Head Alignment
Four Approach Lanes
Configuration C

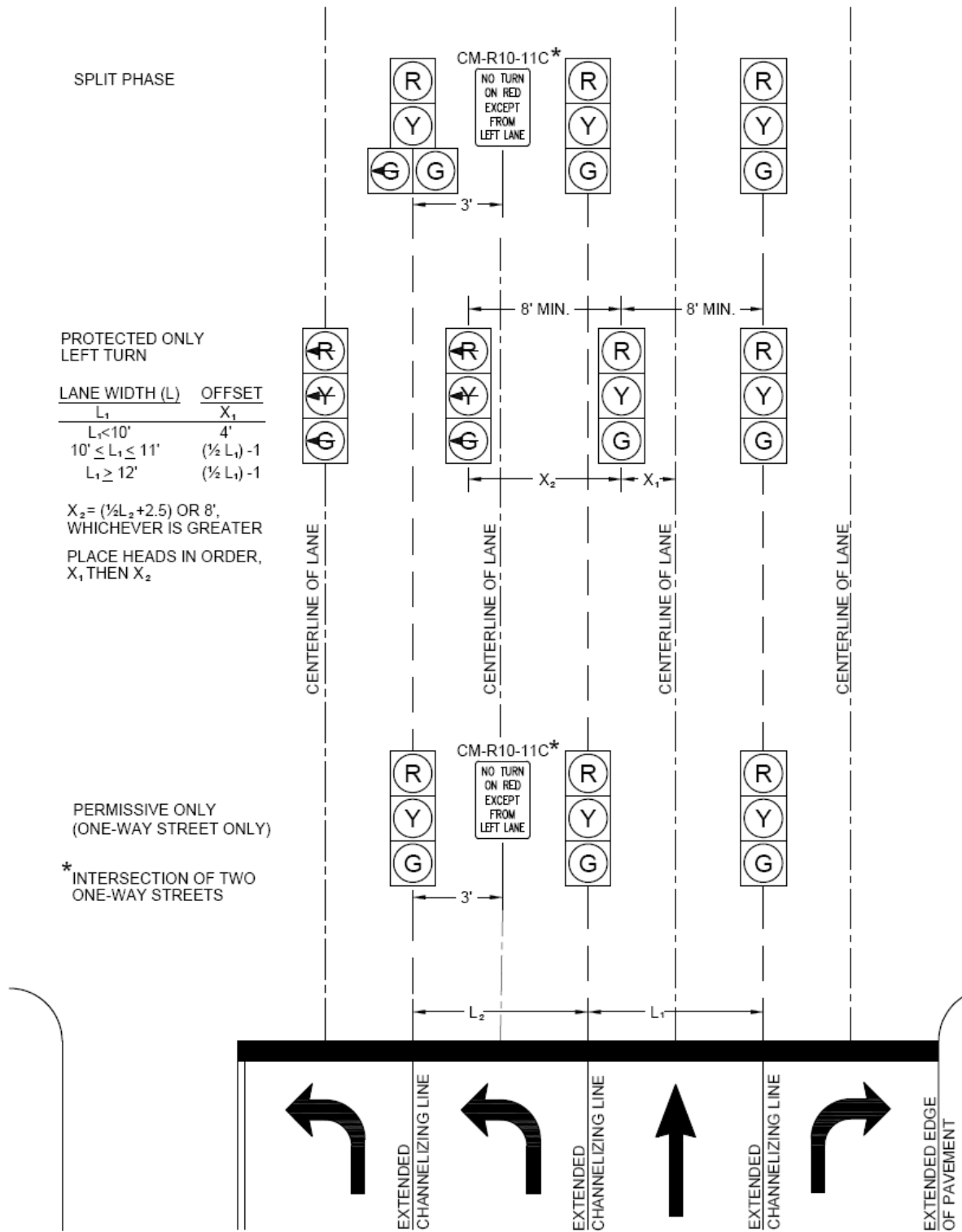

Figure 5.23
Vehicular Signal Head Alignment
Four Approach Lanes
Configuration D

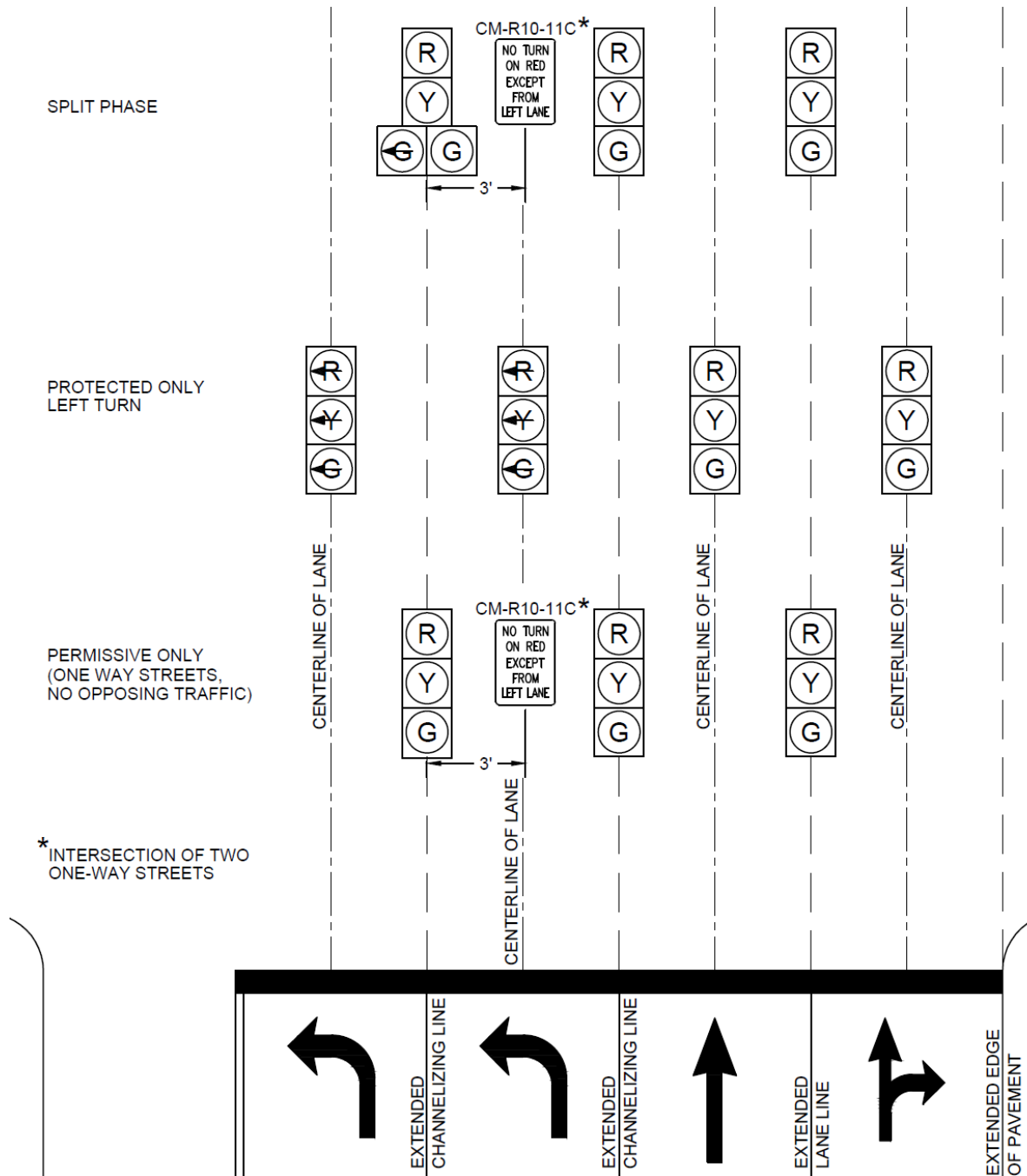

Figure 5.24
Vehicular Signal Head Alignment
Four Approach Lanes
Configuration E (1 of 2)

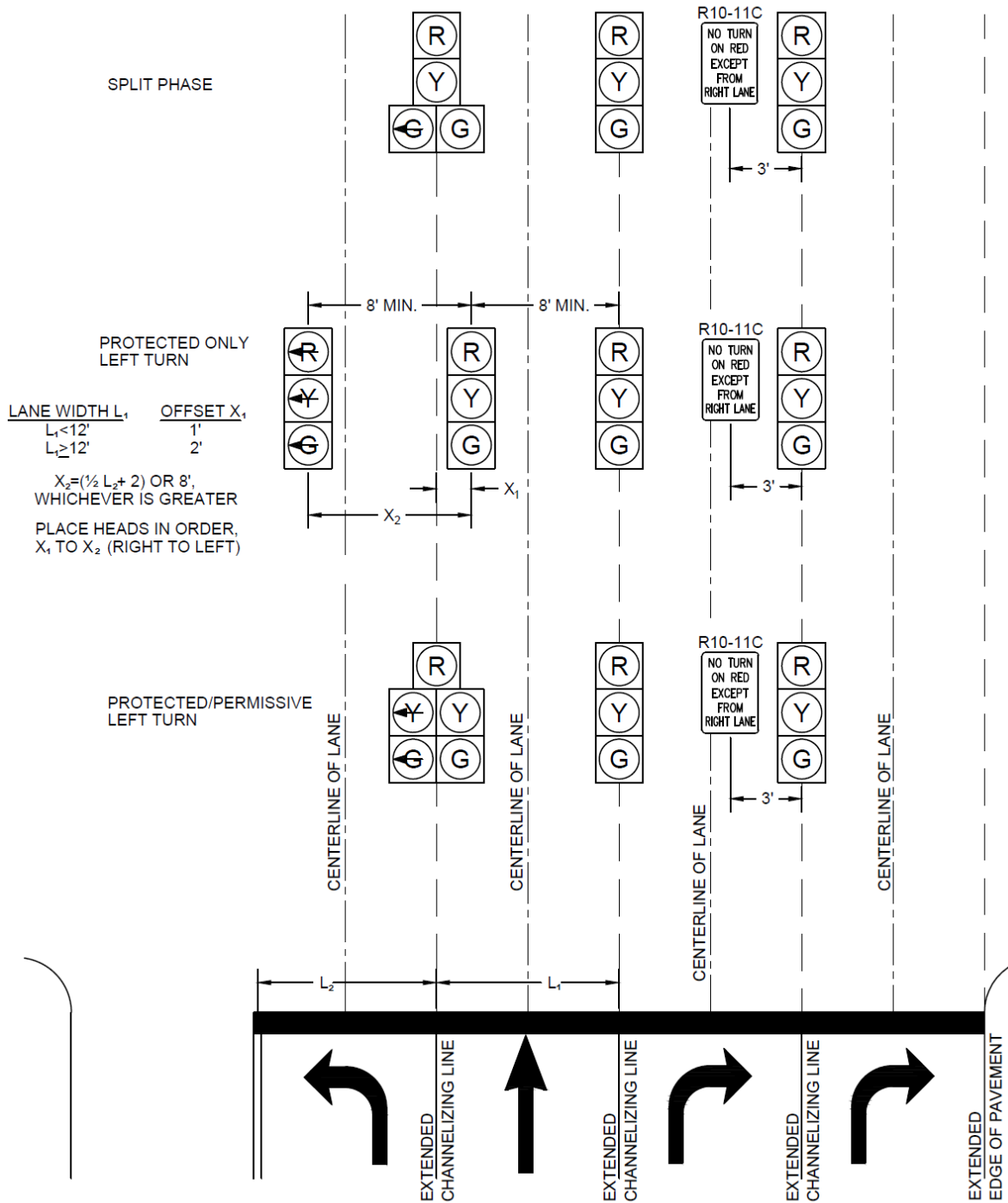

Figure 5.25
Vehicular Signal Head Alignment
Four Approach Lanes
Configuration E (2 of 2)

* IF RIGHT TURN ON RED IS PERMITTED

** SEE O MUTCD 4D.23 PARAGRAPH 03 A.2.
 IF AN R10-10R SIGN IS REQUIRED,
 CENTER IT BETWEEN RIGHT TURN HEADS
 AND INSTALL THE R10-11C SIGN 3' TO LEFT
 OF LEFT-MOST RIGHT TURN HEAD.

PROTECTED ONLY
 RIGHT TURN

LANE WIDTH (L)	OFFSET
L_1	X_1
$L_1 < 10'$	4'
$10' \leq L_1 \leq 11'$	$(\frac{1}{2} L_1) - 1$
$L_1 \geq 12'$	$(\frac{1}{2} L_1) - 1$

$X_2 = (\frac{1}{2} L_2 + 2.5)$ OR 8',
 WHICHEVER IS GREATER

PLACE HEADS IN ORDER,
 X_1 THEN X_2

PROTECTED/PERMISSIVE
 RIGHT TURN

PERMISSIVE ONLY

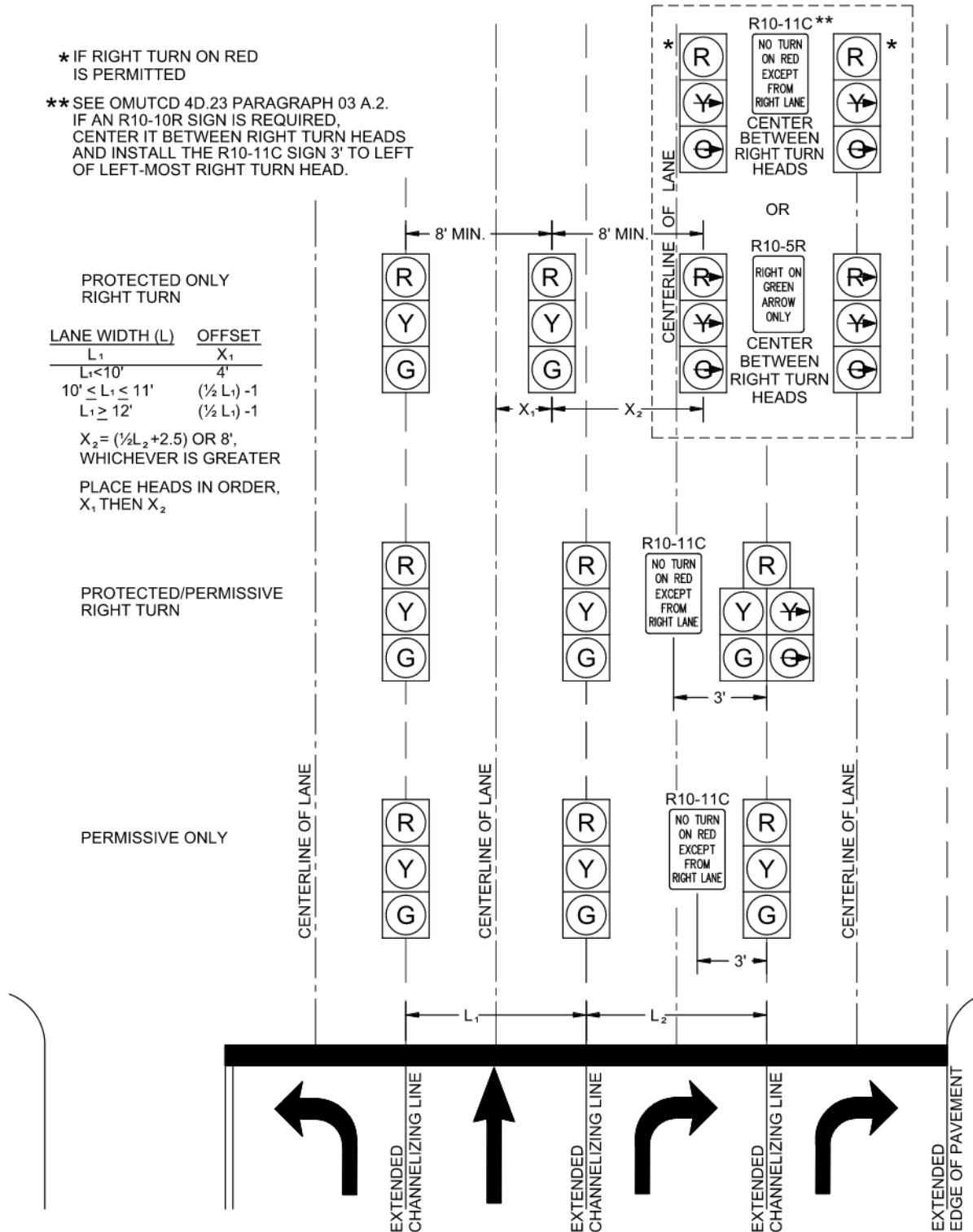

Figure 5.26
Vehicular Signal Head Alignment
Four Approach Lanes
Configuration F

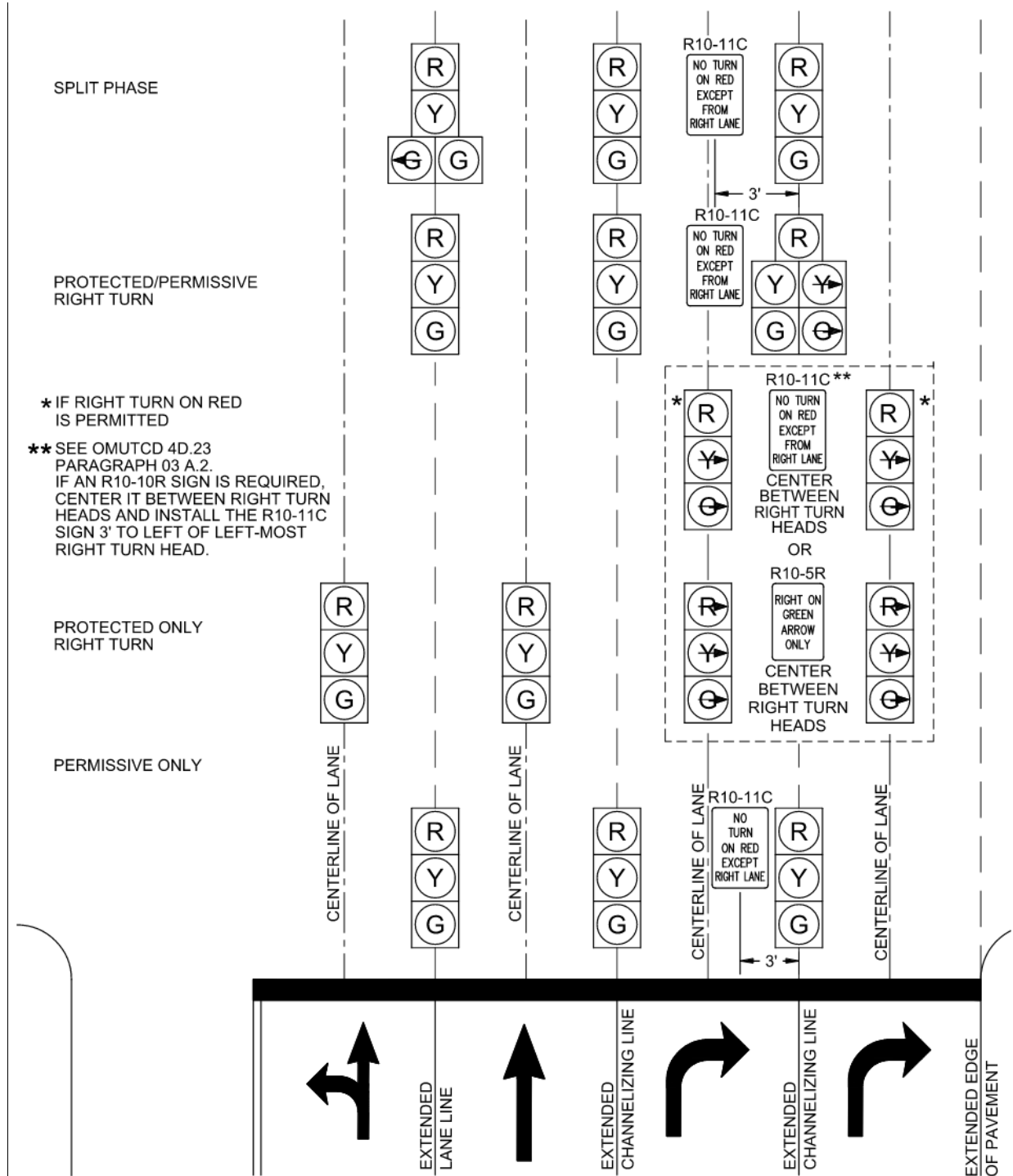
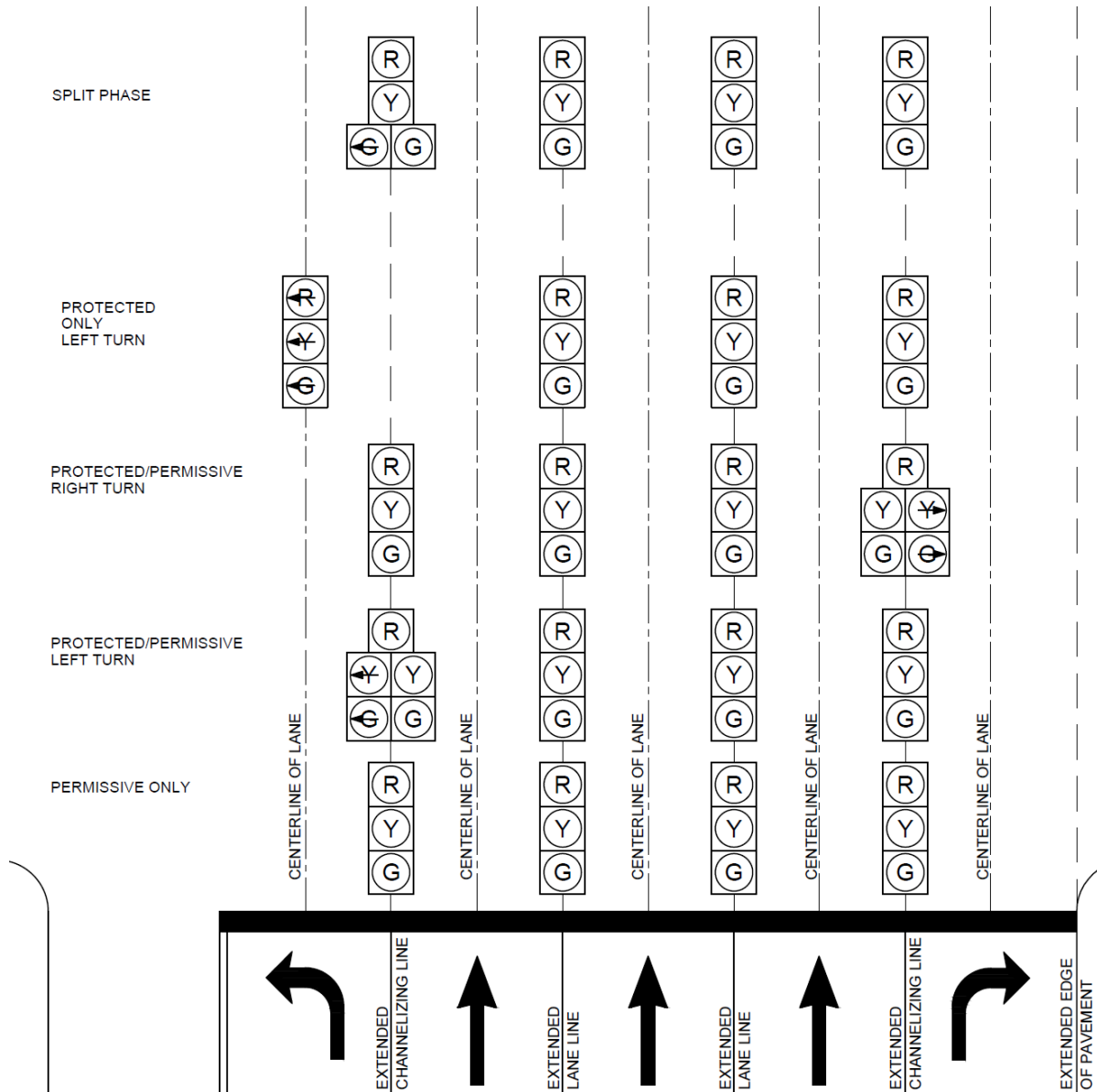
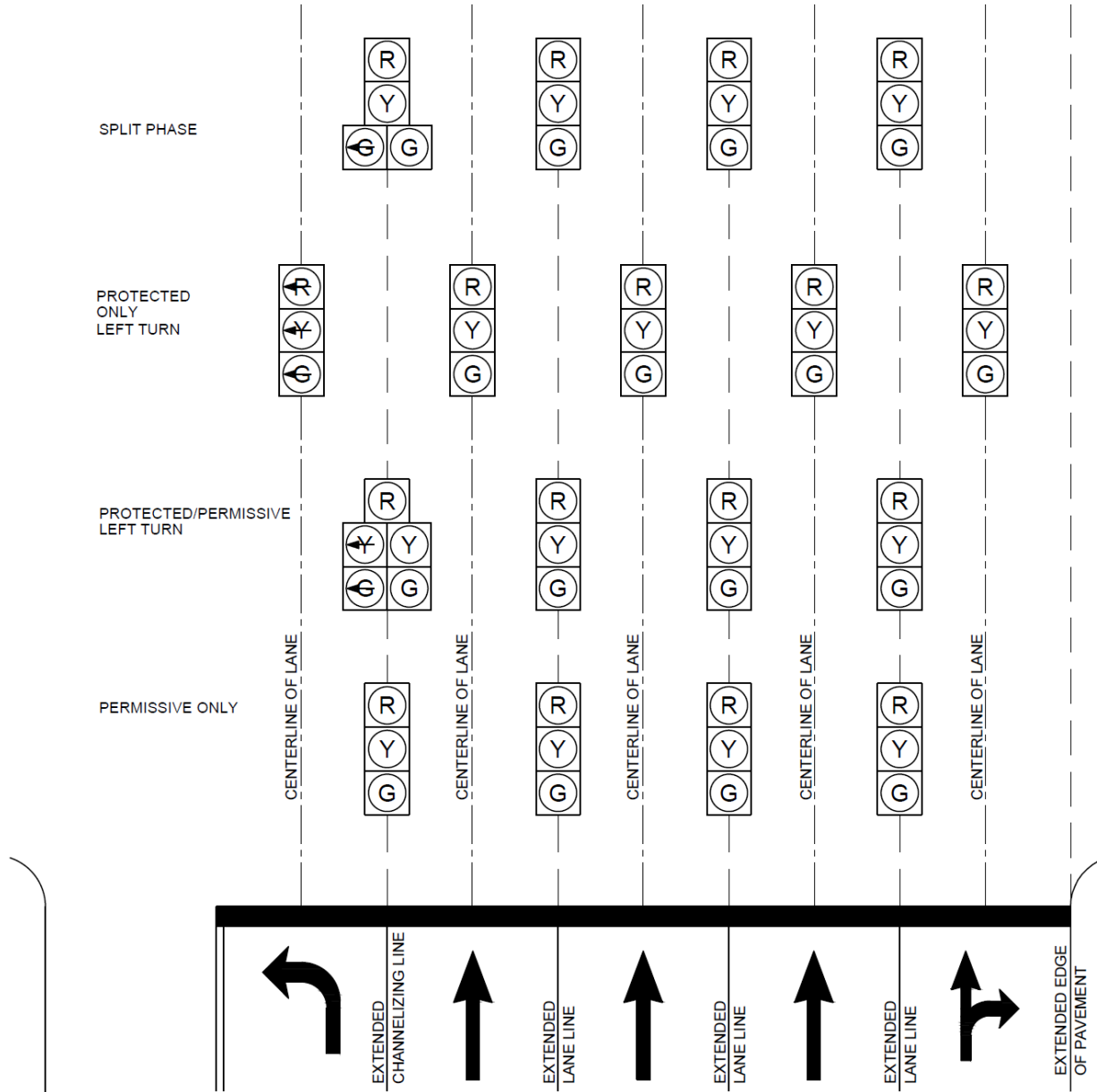

Figure 5.27
Vehicular Signal Head Alignment
Five Approach Lanes
Configuration A
 (Posted Speed < 45 MPH)*



* For posted speeds 45 MPH or higher, see OMUTCD Section 4D.11

Figure 5.28
Vehicular Signal Head Alignment
Five Approach Lanes
Configuration B
 (Posted Speed < 45 MPH)*



* For posted speeds 45 MPH or higher, see OMUTCD Section 4D.11

Figure 5.29
Vehicular Signal Head Alignment
Five Approach Lanes
Configuration C (1 of 2)

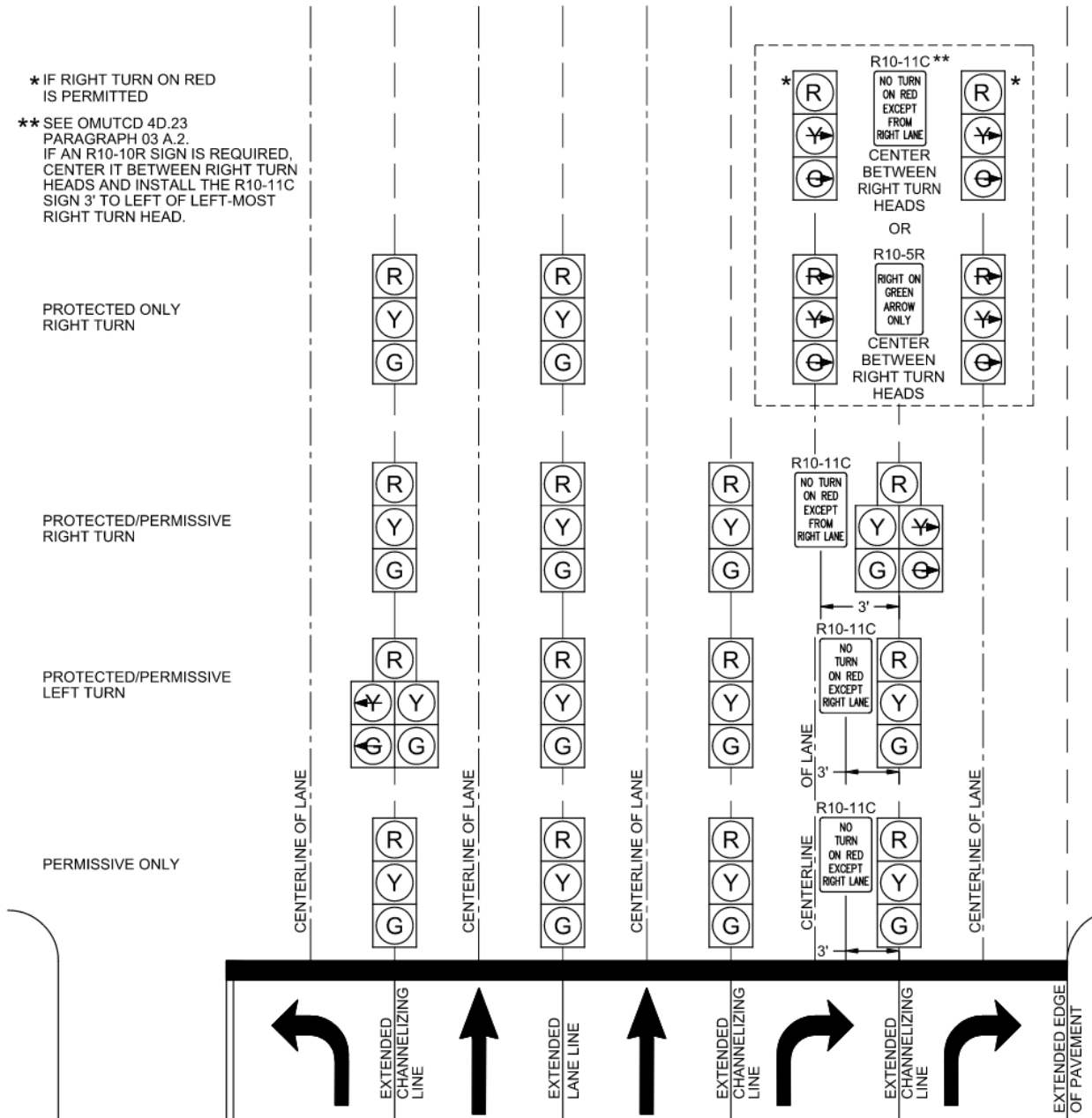

Figure 5.30
Vehicular Signal Head Alignment
Five Approach Lanes
Configuration C (2 of 2)

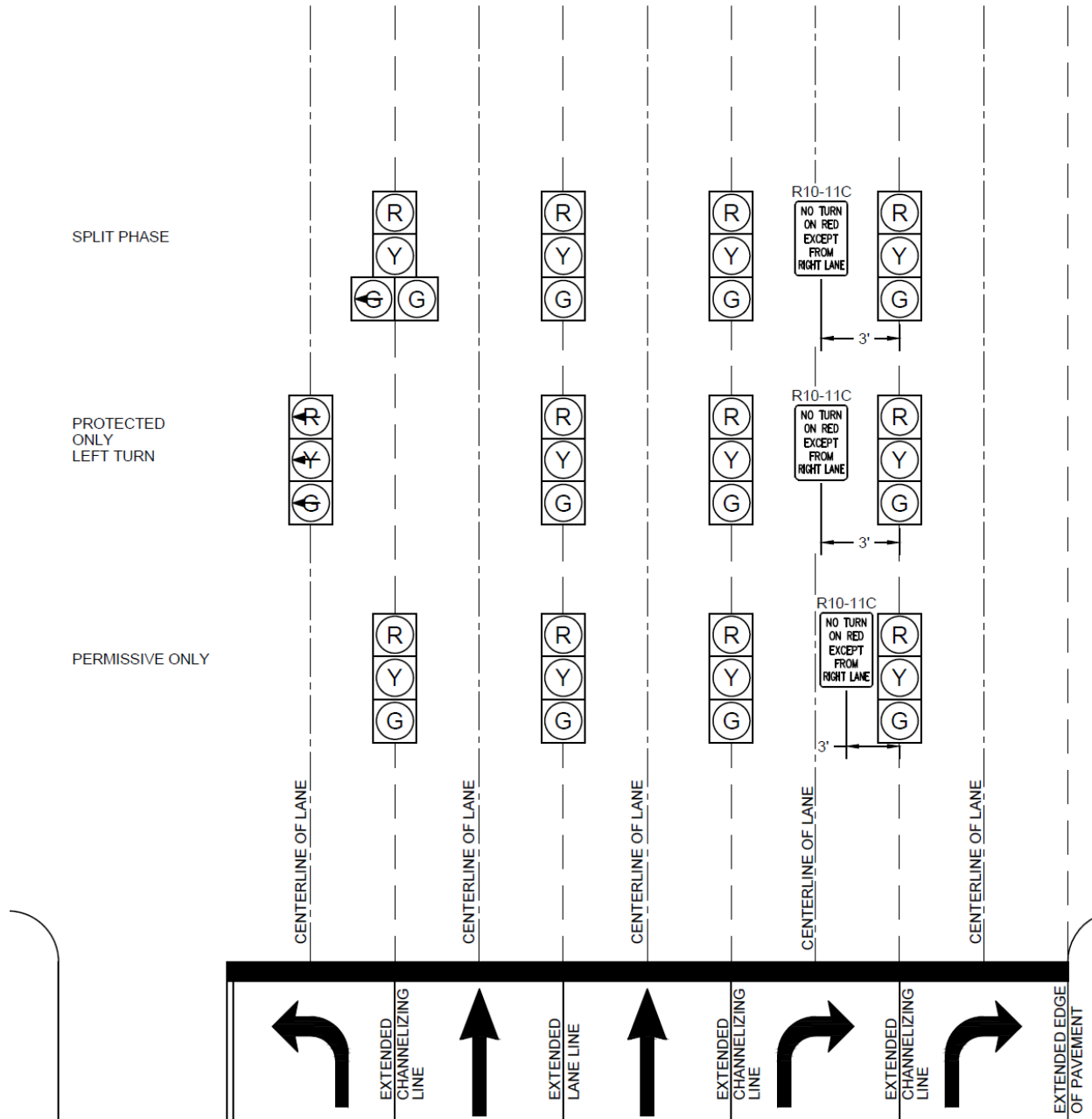

Figure 5.31
Vehicular Signal Head Alignment
Five Approach Lanes
Configuration D

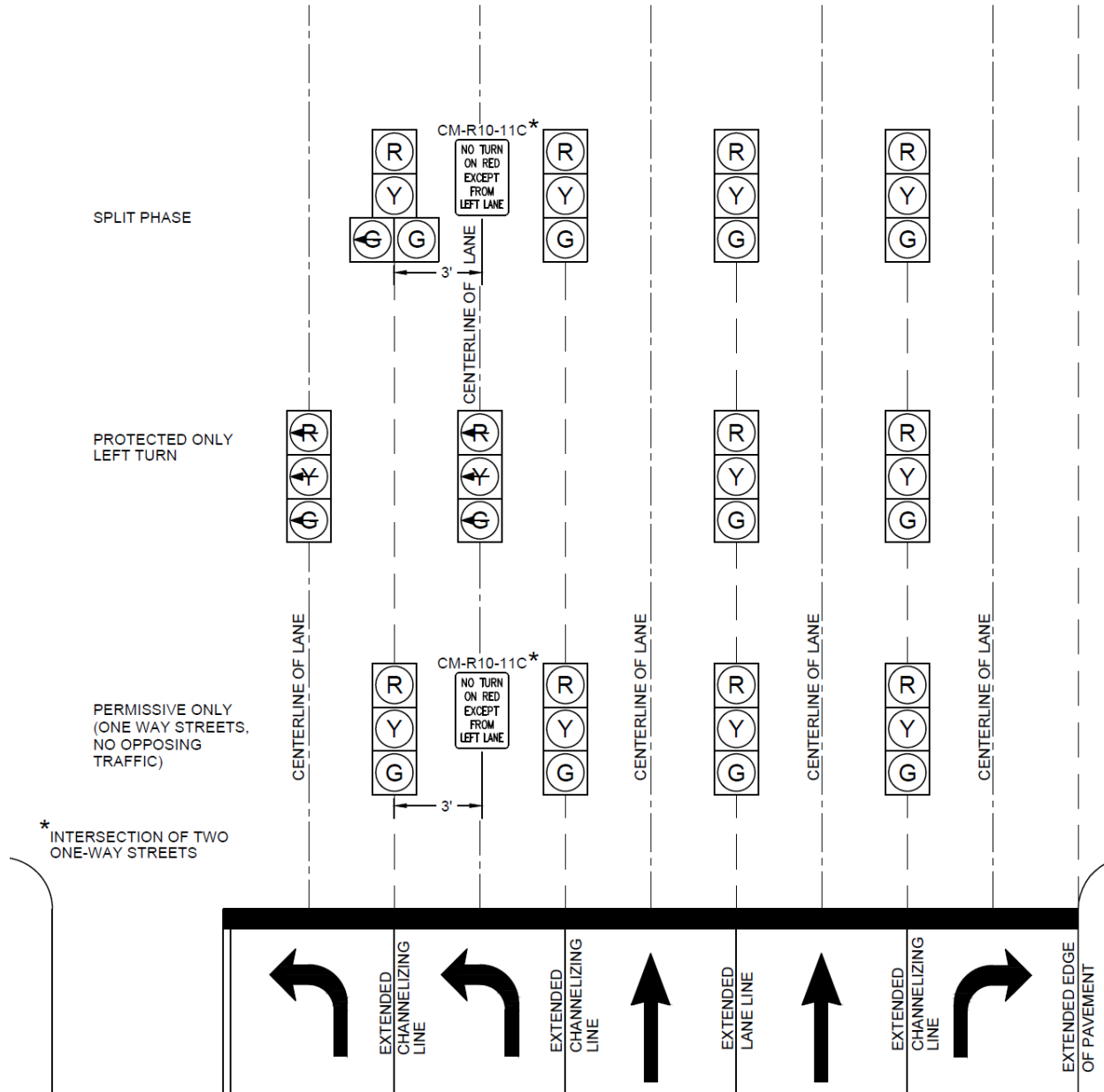

Figure 5.32
Vehicular Signal Head Alignment
Offset Left Turn Lane
Configuration A
 (Offset < 5 FT)

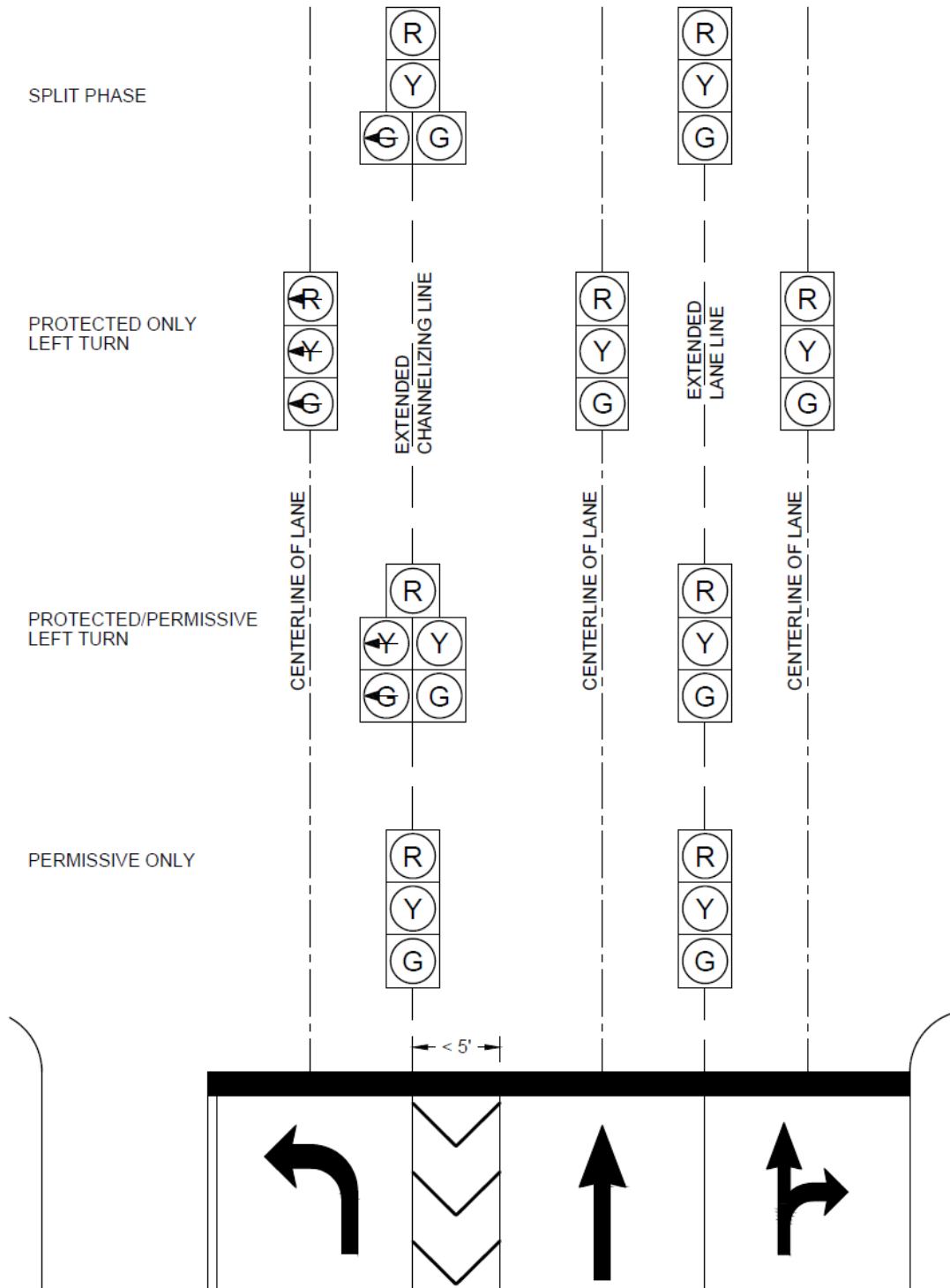

Figure 5.33
Vehicular Signal Head Alignment
Offset Left Turn Lane
Configuration B
 (Offset ≥ 5 FT)

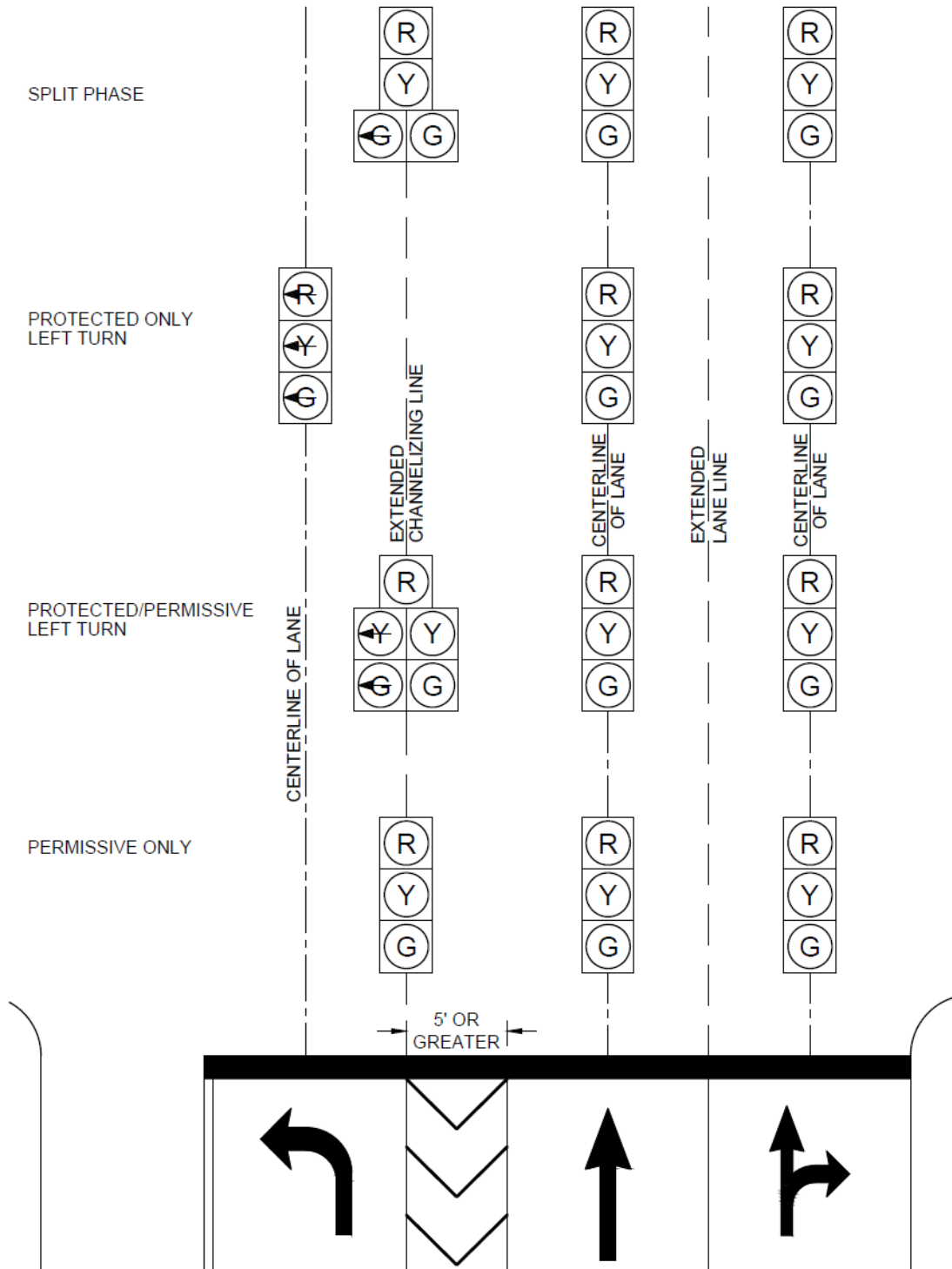

Figure 5.34
Vehicular Signal Head Alignment
Offset Left Turn Lane
Configuration C
Exclusive Right Turn Lane

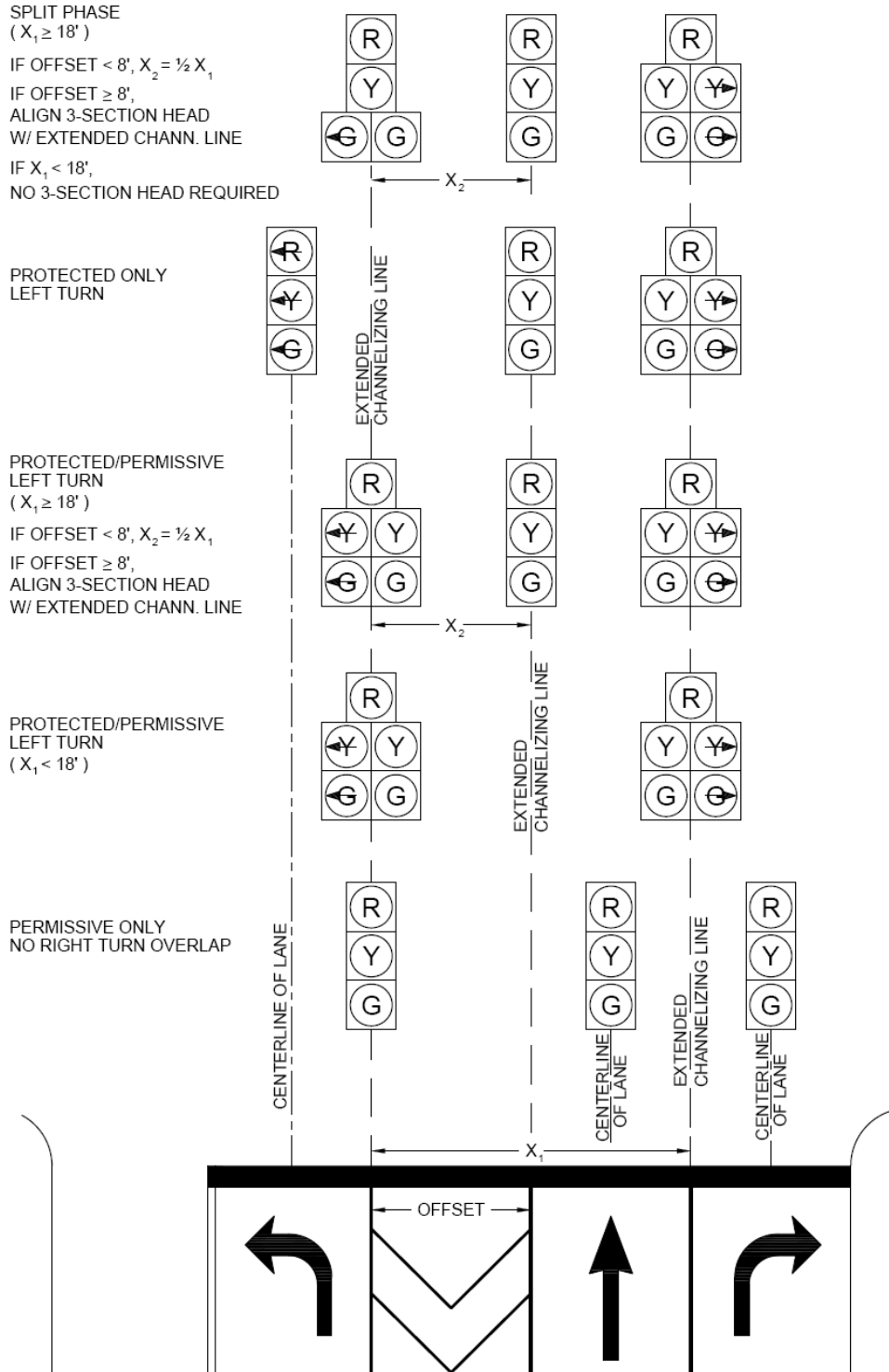

Figure 5.35
Vehicular Signal Head Alignment
Presence of Bike Lane
(1 of 2)

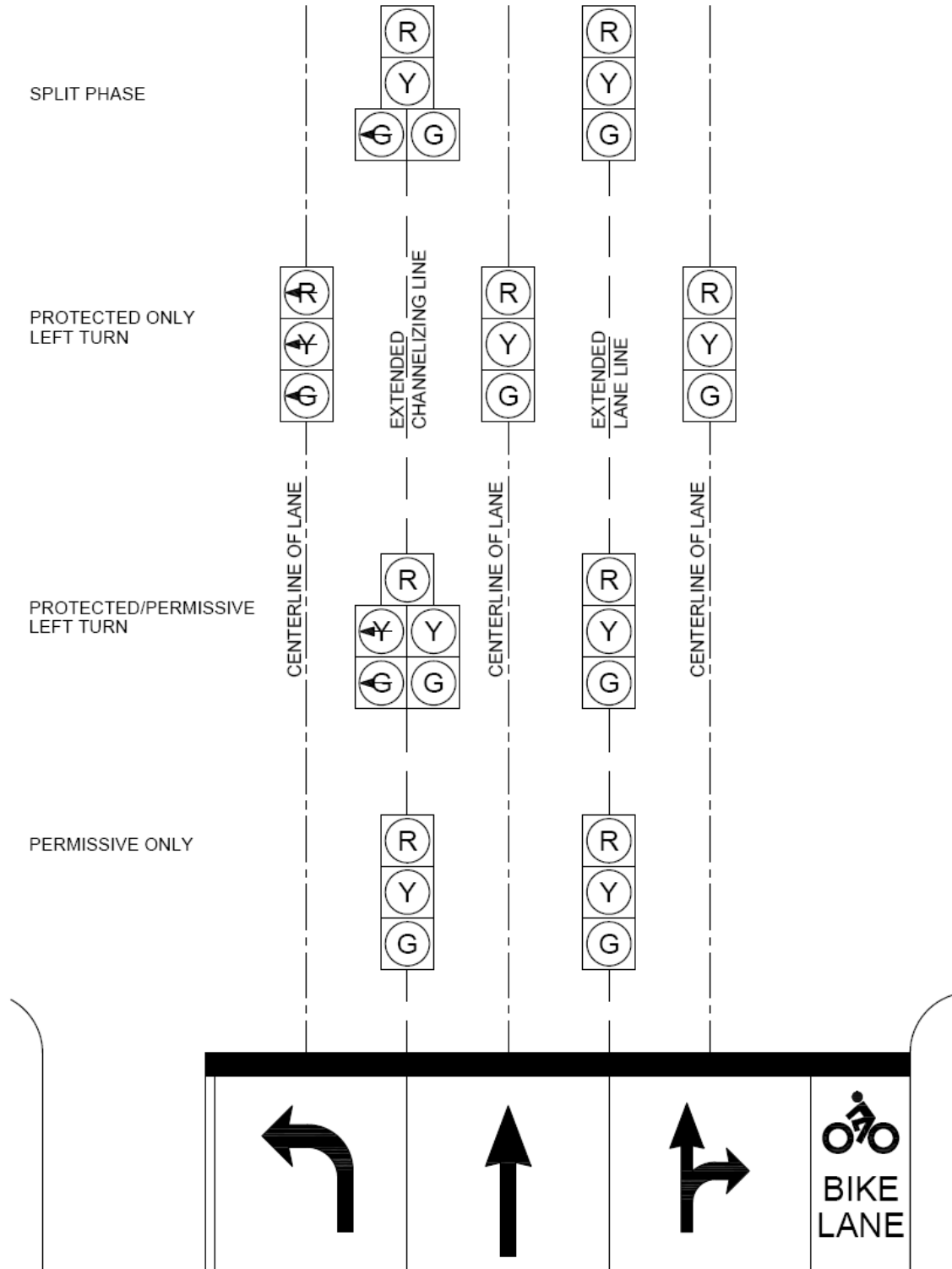
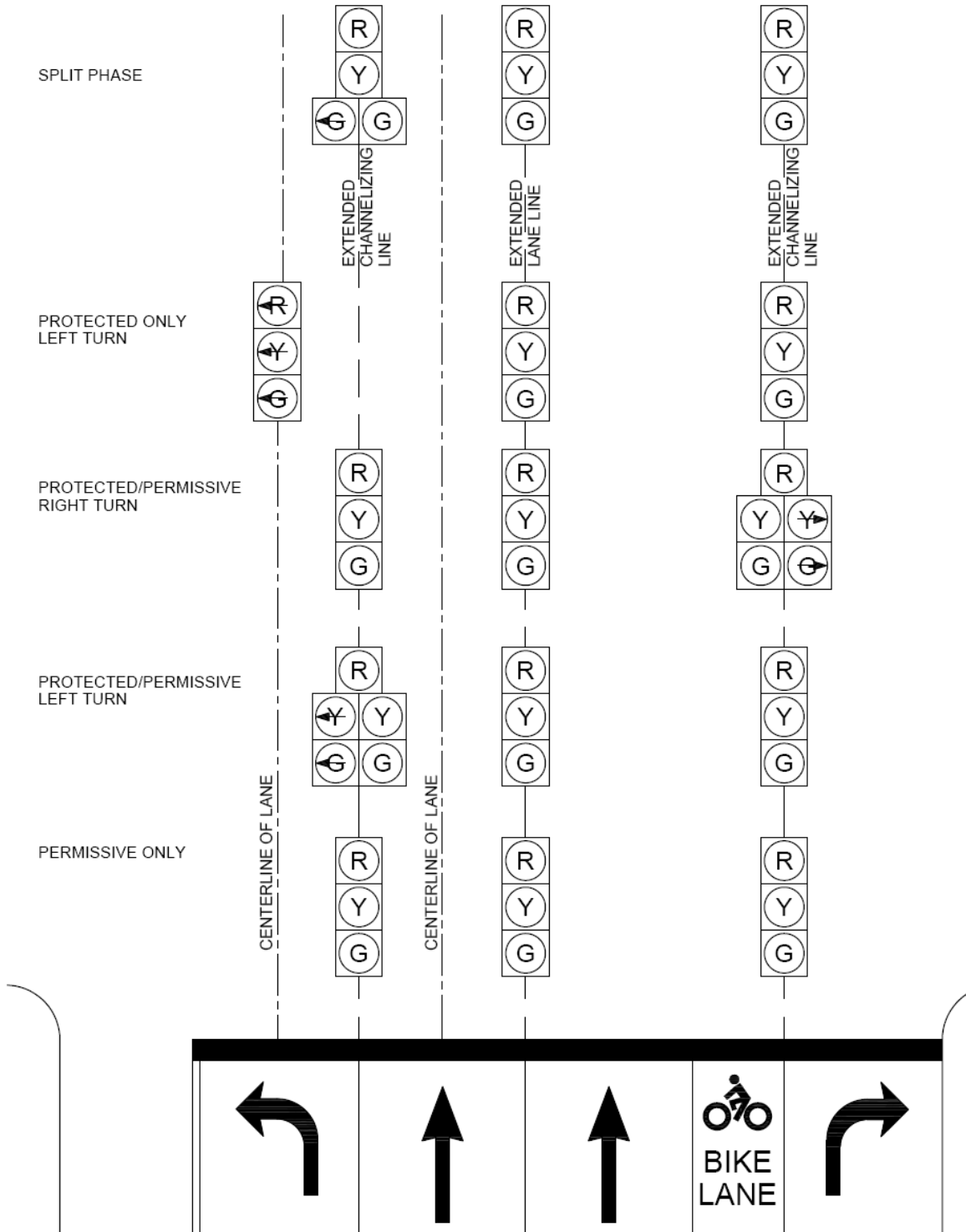

Figure 5.36
Vehicular Signal Head Alignment
Presence of Bike Lane
(2 of 2)



CHAPTER 6: PEDESTRIAN FEATURES

6.1 Pedestrian Signal Heads

Pedestrian signal heads shall be used in conjunction with vehicular traffic control as outlined in Section 4E.03 of the [Ohio Manual of Uniform Traffic Control Devices](#). Pedestrian signal heads shall be used for all new pedestrian crossings at signalized intersections.

Marked crosswalks shall be used where pedestrian signal units control the crossing.

Pedestrian signal heads shall be installed on 10.7' pedestals (or larger) or on signal poles in pushbutton-compliant locations for each crosswalk regardless if a pushbutton is currently needed for the crosswalk.

If substantial utility relocation at the expense of the City is necessary to install the pedestrian signal head on a pedestal, and a pushbutton is not currently needed for a crosswalk, the pedestrian signal head may be installed on other signal poles or pedestals not located in pushbutton-compliant locations for the corresponding crosswalk with prior approval.

6.1.1 Material Specifications

Pedestrian signal heads shall be in accordance with 632 and 732 of the current version of the [City of Columbus Construction and Material Specifications](#) and current revision of [Supplemental Specification 1100](#). Pedestrian heads shall be symbolic LED, countdown, filled hand/filled person units.

Materials shall also be in accordance with the City of Columbus [Qualified Products List](#).

6.1.2 Pedestrian Head Mounting

Pedestrian signal heads shall be mounted as detailed on [City of Columbus Standard Construction Drawing 4200](#).

Figure 6.1
Pedestrian Signal Head

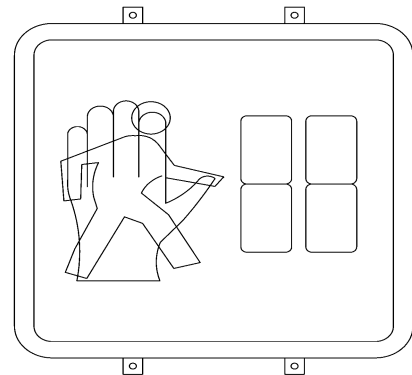

6.1.3 Pedestrian Head Alignment

Pedestrian signal heads shall be aimed at the center of the crosswalk area (not the curb ramp) that is opposite the unit. Head alignment is detailed in **Figure 6.2**. Reference is made to the [City of Columbus Construction and Material Specifications](#), 632.08.

Horizontal orientation of the signal head on the pole shall be specified in the pole orientation/fabrication data chart to an accuracy of +/- 1 degree.

6.1.4 Pedestrian Head Color

The pedestrian signal head housing and clam shell mounting brackets shall be black, matching Federal Standard 595B, Color # 27038.

6.1.4.1 Special Pedestrian Head Color

In designated special districts, pedestrian heads may have the housing painted a color other than black; the area and color shall be subject to advanced approval by the City of Columbus, Director of the Department of Public Service or appointed designee. These specially colored heads will be supplied (for initial installation and for maintenance) by the Sponsor, “governing authority” of the special district pursuant to a written installation and maintenance agreement. Colors shall be coordinated with the requirements of **Section 5.1.5.1**.

Figure 6.2
Pedestrian Signal
Head Alignment

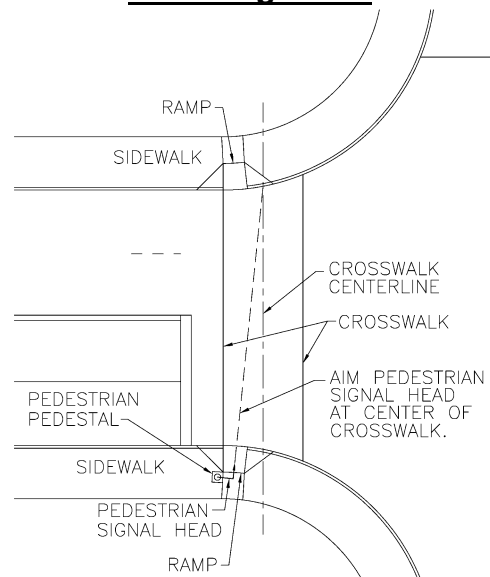

6.2 Pedestrian Pushbuttons

Pushbuttons and pushbutton signs shall be used anytime a pedestrian is allowed to cross at a signalized intersection and the signal phase associated with that crossing is actuated. Pedestrian pushbutton activation shall call the associated signal phase and provide adequate crossing time as outlined in **Section 15.1.4**.

One pedestrian pushbutton sign shall be supplied with each pushbutton. The bottom of the sign shall be mounted just above the top of the pushbutton. Signs shall be as illustrated in **Figure 6.3** and detailed on [City of Columbus Standard Construction Drawing 4230](#). For pushbuttons located at the side of the landing area, sign R10-3a shall be used.

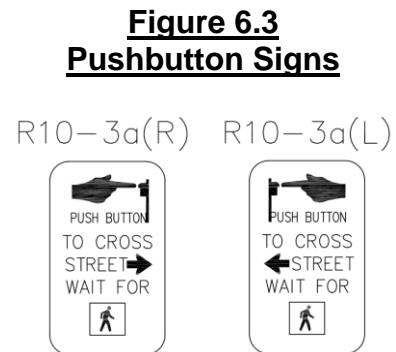

Pedestrian pushbuttons use and placement shall be in conformance with the requirements of the referenced City of Columbus documents listed in **Sections 6.2.1**, and **6.2.2**.

6.2.1 Pushbutton Specifications

Pedestrian pushbuttons shall be in accordance with 632 and 732 of the current version of the [City of Columbus Construction and Material Specifications](#).

Materials shall also be in accordance with the City of Columbus [Qualified Products List](#).

6.2.2 Pushbutton Location/Mounting

The mounting height and location of pedestrian pushbuttons shall be in accordance with the [City of Columbus Construction and Material Specifications](#), Section 632.09 and with the [ADA Rules and Regulations](#) as published by the City of Columbus.

If a traffic signal support pole cannot be located in an acceptable location, as defined in the [ADA Rules and Regulations](#) document, a pedestrian pedestal (see **Section 4.1.5**) shall be used to position the pedestrian pushbutton in a conforming location.

6.3 Accessible Pedestrian Signals

All signalized intersections shall provide the underground conduit infrastructure needed to facilitate the application of accessible pedestrian signals for each leg of the intersection. When a pedestal or signal pole cannot be installed in a pushbutton-compliant location for each crosswalk, underground conduit, capped, with tracing wire shall be installed to all future pedestal locations. Actual design of accessible pedestrian signal features will be as directed by the City of Columbus, Department of Public service. Any deviation must be approved by the City of Columbus, City Engineer or appointed designee.

6.3.1 Accessible Pedestrian Signals Specifications

Accessible pedestrian signals shall conform to the requirements of the latest edition of the [Ohio Manual of Uniform Traffic Control Devices](#).

Materials shall be in accordance with the City of Columbus [Qualified Products List](#).

6.3.2 Installation Requirements

Location of the pedestrian pushbutton shall be as specified in **Section 6.2.2**.

Wiring for all accessible pedestrian features shall use standard City of Columbus pedestrian pushbutton and pedestrian signal wiring standards. Additionally, a 4/C cable will be installed from the control panel located in the pedestrian signal head to the pedestrian pushbutton station.

One pushbutton sign shall be supplied with each accessible pedestrian signal. At intersections where the major street pedestrian phase is on recall, the signs to cross the major street shall be per SCD 4230. The signs to cross the side street shall be the alternative CM-R73C.03 (9 in. x 15 in.) black and white pushbutton sign with the following text: "Push Button for Audible Signal to Cross (Street Name)." At intersections which are fully actuated, all pushbutton signs shall be per SCD 4230.

Figure 6.4
Audible Pushbutton Sign



The minimum walk time shall be 10 seconds for crossing with accessible pedestrian signals. Pedestrian clearance time shall be based on the requirements of the latest edition of the [Ohio Manual of Uniform Traffic Control Devices](#).

CHAPTER 7: INTERSECTION WIRING

7.1 Intersection Wiring

Signalized intersections and signal systems shall be designed in accordance with the [National Electrical Code](#) and [National Electrical Safety Code](#) unless otherwise noted in this manual.

Intersection wiring discussed in this chapter is defined as cables used to connect the traffic signal controller/cabinet with individual signal heads, pedestrian heads, pushbuttons and other traffic signal devices. Power and service cable wiring have been detailed in **Chapter 10**. Interconnect cable has been detailed in **Chapter 12**.

7.2 Material Specifications

Traffic signal wiring shall be designed in accordance with the requirements outlined in Sections 632 and 732 of the current version of the [City of Columbus Construction and Material Specifications](#). All wiring shall also be in conformance with the specifications outlined in the [Official Wire & Cable Specifications Manual](#) as published by the International Municipal Signal Association (IMSA).

Materials shall be in accordance with the City of Columbus [Traffic Qualified Products List](#).

7.3 Grounding and Bonding

An effective ground fault current path (bonding system) shall be provided on all new or modified traffic signals. If a portion of an existing traffic signal is modified by the addition or relocation of a strain pole/mast arm or if a new cabinet is installed, the entire traffic signal installation shall be upgraded to provide for a complete grounding and bonding system. The addition of pedestrian pedestals to an existing intersection will not trigger the need to upgrade the entire intersection.

The effective ground fault current path back to the ground bus bar in the controller cabinet shall be designed for all non-current carrying metallic parts containing electrical conductors in the signal system. The equipment ground shall be connected to the service neutral in the traffic signal cabinet only.

Grounding and Bonding plan notes as provided by the City of Columbus shall be included in the traffic signal plan. A grounding and bonding wiring diagram shall be included in the plan to illustrate how individual traffic signal components are connected to the grounding and bonding system. Examples of a “Grounding and Bonding” wiring diagram are illustrated in **Figures 7.1** and **7.2**. The grounding and bonding system shall be designed to minimize the number of conductors needed.

Grounding and bonding conductors shall provide for a direct connection between all non-current carrying metallic parts without the use of underground splices or lug connections. Grounding and bonding connections shall be made in the base of signal poles, pedestals, or in cabinets only. The only exception shall be a direct connection to the pull box frame for the purposes of grounding and bonding an individual metallic pull box lid/frame. Grounding and bonding conductors that continue through the pull box serving other signal components, shall not be connected to the pull box grounding and bonding lug.

Figure 7.1
Grounding and Bonding Wiring Illustration
Mast Arm Example

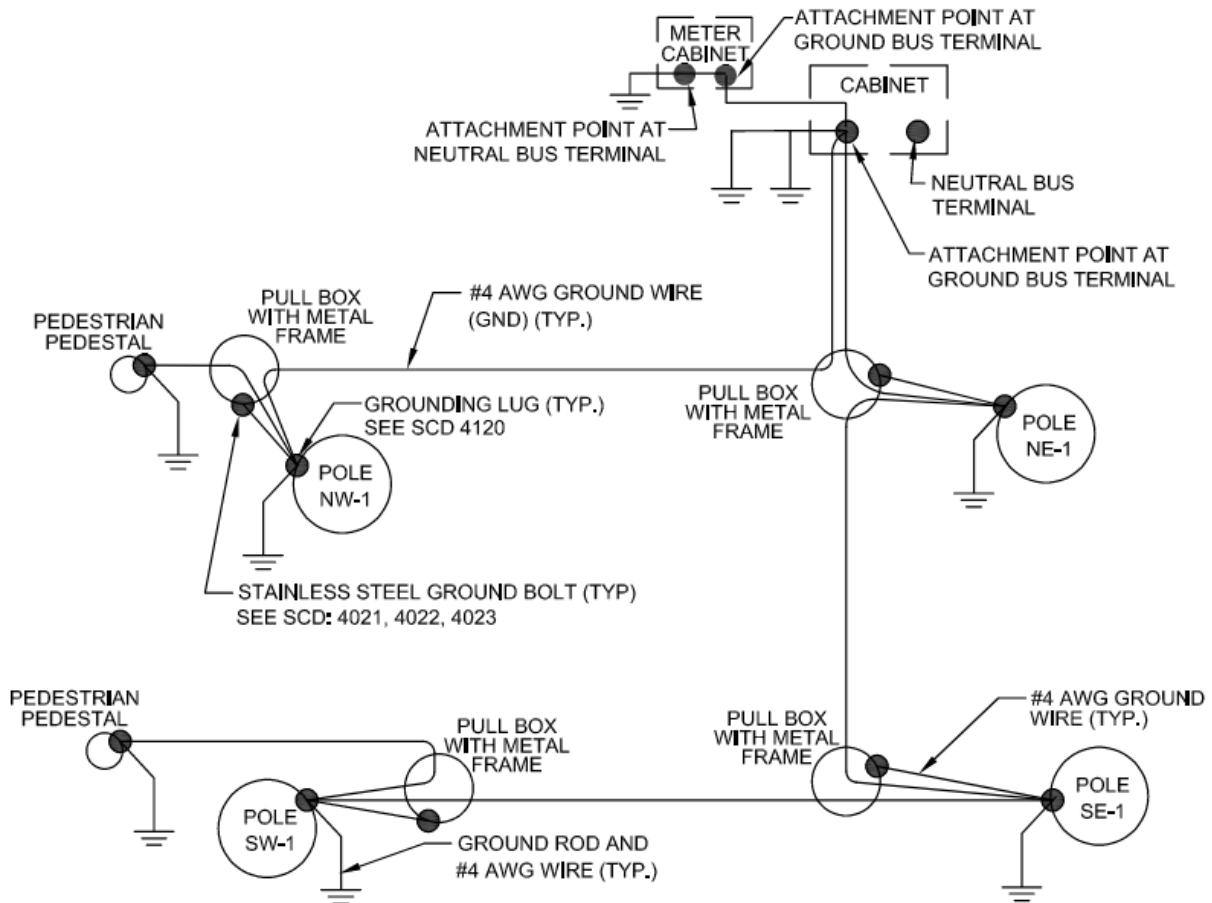
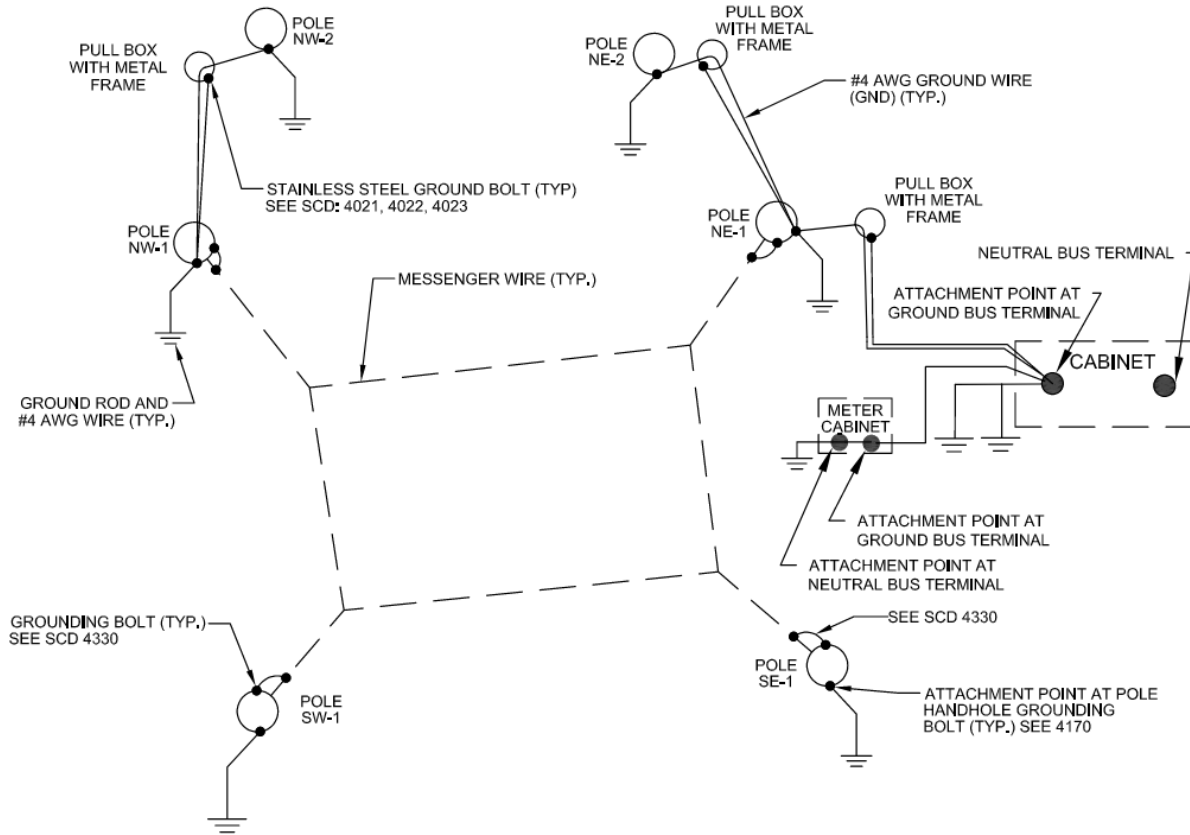

Figure 7.2
Grounding and Bonding Wiring Illustration
Span Wire Example



7.3.1 Ground Rods

A minimum of 1 ground rod shall be used at each strain pole, mast arm pole, pedestal pole or any other support that contains traffic signal cable and/or contains traffic signal features such as: vehicular signal heads, pedestrian signal heads and pedestrian pushbuttons.

A minimum of 2 ground rods shall be used at any enclosure that houses traffic signal control equipment. When a pole mounted cabinet is used, 2 schedule 40, PVC conduits shall be installed in the pole foundation for ground wire use. One conduit shall contain the ground wire attached to the pole base and the second conduit shall contain the ground wire attached to the traffic signal cabinet. The conduits shall be on opposite sides of the pole foundation.

Additional ground rods may be required to meet the resistance values published in Section 625.16 of the [City of Columbus Construction and Material Specifications](#).

7.4 Number, Color and Gauge of Conductors

All intersection wiring shall conform to the requirements of Table 732.19-1 (Cable and Wire) of the [City of Columbus Construction and Material Specifications](#).

Signal cable shall have a minimum gauge of 14 AWG.

Cable shall consist of 2, 3, 4, 7, 9 and 10 conductors. Signal cable color coating and the minimum number of conductor requirements are summarized in **Tables 7.1, 7.2 and 7.3**. Tagging of the phase and direction on the cable is required, but not for the individual conductors. Use the minimum number of conductors required to satisfy the requirements. If a future signal phase is anticipated, the cable specified should accommodate this future condition.

Signal cable shall run between the traffic signal control cabinet and the signal device without splices. Splices shall only be permitted at termination blocks located inside vehicular or pedestrian head housings.

7.4.1 Vehicular Signal Head Wiring

For span wire and mast arm configurations, provide 1 circuit to each set of approach heads. The minimum number of conductors per circuit shall be 7. A 5-section right turn head requires a 9 conductor cable. After the right turn head is served, a 7 conductor cable should be used to feed the remainder of the heads on the same approach. Examples of vehicular signal head cable routing are illustrated in **Figure 7.3**. Vehicular signal cable color coding and the minimum number of conductor requirements are summarized in **Tables 7.1 and 7.3**.

A maximum of (2) - 10 conductor cables shall enter an individual vehicular traffic signal head.

7.4.2 Pedestrian Signal Head Wiring

One (maximum of 2) pedestrian signal cable(s) should be used to serve all pedestrian signal heads at an individual intersection.

Jumpered connections shall occur inside pedestrian signal housings. The only locations that the multi-conductor jackets may be removed are in controller cabinets and signal head housings.

The number of conductors used to serve individual pedestrian units is based on the location of the traffic signal control cabinet, the direction (clockwise or counter-clockwise) of cable routing and if crosswalks are planned for individual legs of an intersection. In order to satisfy color coding requirements, pedestrian signal heads serving the east crosswalk require a 9 conductor cable. Pedestrian signal heads serving the north,

west and south crosswalks require a minimum 7 conductor cable. Pedestrian signal cable color coding and the minimum number of conductor requirements are summarized in **Tables 7.1** and **7.2**.

Examples of pedestrian signal cable routing are illustrated on **Figure 7.4**.

7.4.3 Pedestrian Pushbutton Wiring

Pedestrian pushbuttons shall be served with IMSA 50-2, 2-conductor loop lead-in cable. Where practicable, pushbuttons that serve the same phase shall be placed on one circuit.

7.4.4 Accessible Pedestrian Pushbutton Wiring

Wiring for all accessible pedestrian features shall use standard City of Columbus pedestrian pushbutton and pedestrian signal wiring standards as outlined in **Section 7.4.2 and 7.4.3**. Additionally, a 4 conductor cable shall be installed from the control panel located in the pedestrian signal head to the pedestrian pushbutton station.

7.4.5 Illuminated Signs

A minimum 3-conductor cable shall be used to serve illuminated signs, with one conductor being the equipment grounding conductor.

7.4.6 Radar Detection

Cable used to serve radar detection units shall be as recommended by the radar unit manufacturer.

Power to the unit and all data communication shall be transmitted over the radar cable.

The radar unit shall be grounded as recommended by the manufacturer.

Radar detection materials shall be in accordance with the City of Columbus [Qualified Products List](#).

7.4.7 Inductive Loop Detection

Each loop detector shall be served with an individual IMSA 50-2, 2 conductor loop lead-in cable.

7.4.8 Video Detection

Cable used to serve video detection cameras shall be as recommended

by the camera manufacturer.

Digital streaming video output and all data communication shall be transmitted over the camera cable

Video detection materials shall be in accordance with the City of Columbus [Qualified Products List](#).

7.4.9 Emergency Vehicle Preemption

Preemption detector cable shall be as recommended by the preemption system manufacturer.

Emergency Vehicle Preemption materials shall be in accordance with the City of Columbus [Qualified Products List](#).

7.4.10 Railroad Preemption

For additional information see **Section 17.2**.

7.4.11 Transit Priority

For additional information see **Section 17.3**.

Figure 7.3
Typical Vehicular Signal Head Wiring
Per Approach

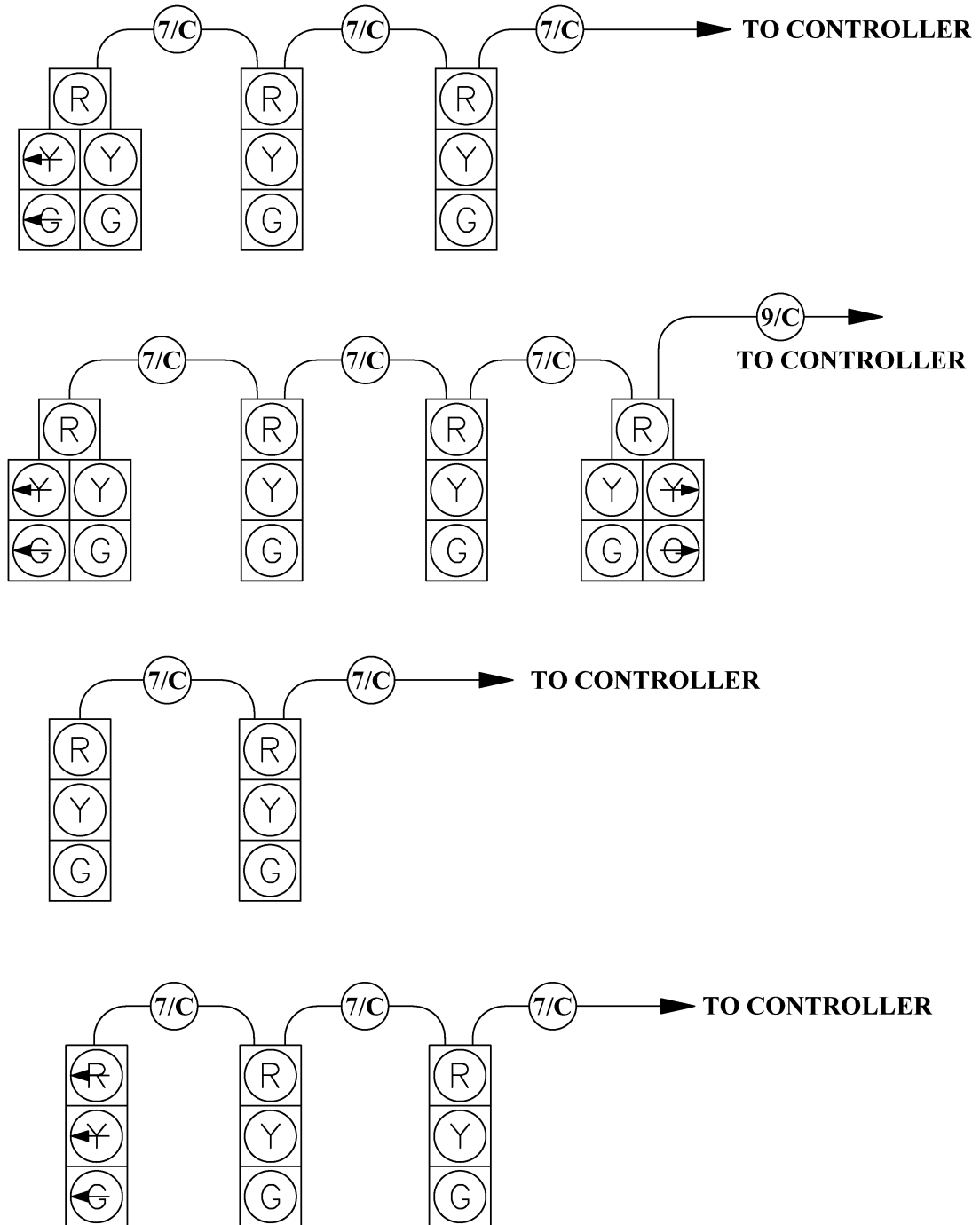

Figure 7.4
Typical Pedestrian Signal Head Wiring

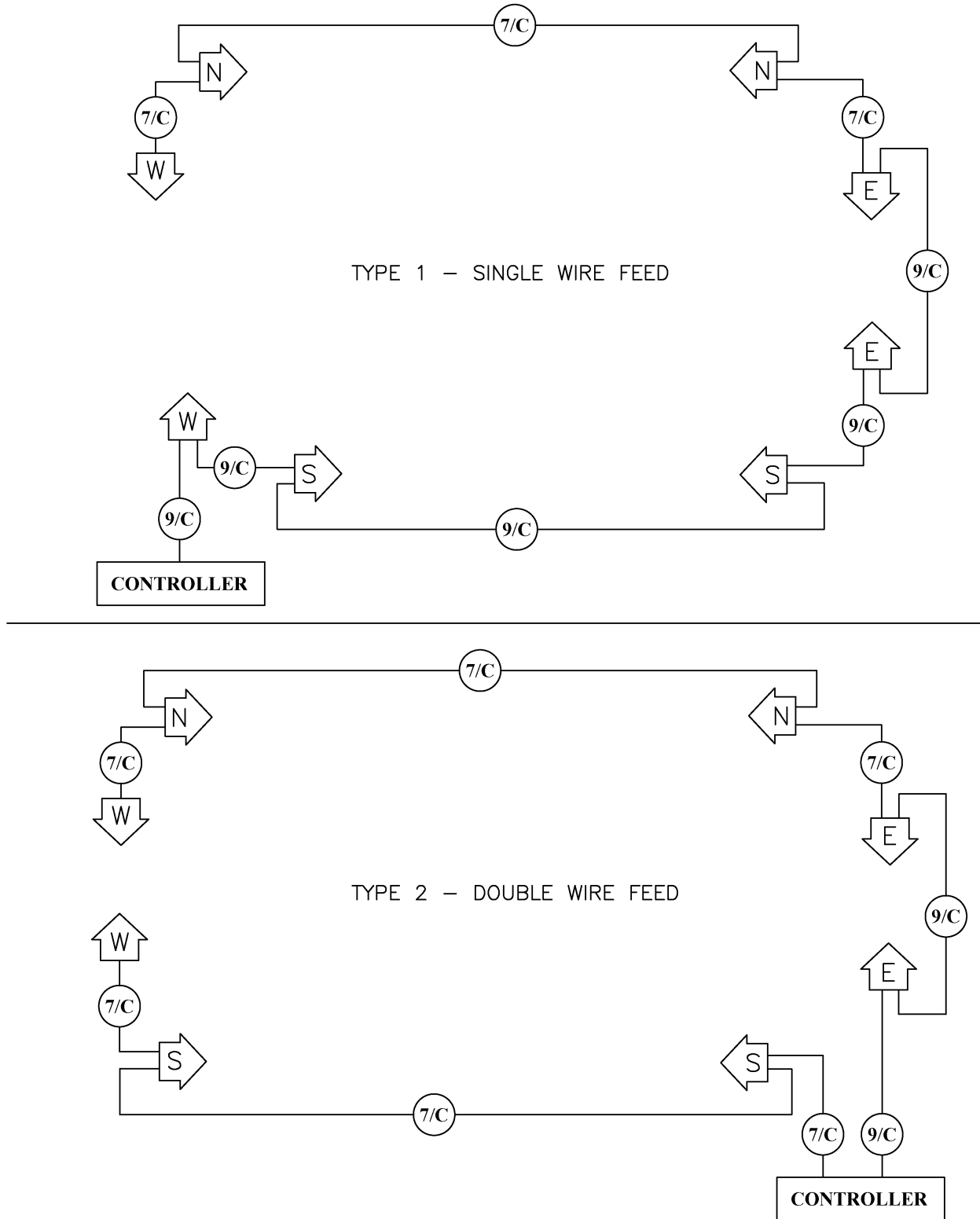

Table 7.1
Minimum Number of Conductors

	Min. Number of Conductors	Min. Gauge
Standard 3 Section Vehicular Signal Head	7	14
Left Turn 3 Section Vehicular Signal Head	7	14
Right Turn 3 Section Vehicular Signal Head	10	14
Left Turn 4 Section Vehicular Signal Head	7	14
Left Turn 5 Section Vehicular Signal Head	7	14
Right Turn 5 Section Vehicular Signal Head	9	14
Pedestrian Pushbutton	2	14
APS (Ped Head to Pushbutton Station)	4	14
South Pedestrian Signal Heads	7	14
West Pedestrian Signal Heads	7	14
North Pedestrian Signal Heads	7	14
East Pedestrian Signal Heads	9	14
Illuminated Sign	3	14
Loop Detector Lead-in Cable	2	14

Table 7.2
Pedestrian Signal Head - Field Wiring Color Codes

Pedestrian Unit Location	Crosswalk Display	Wire Color
South Crosswalk	Walk	Black
	Don't Walk	Orange
West Crosswalk	Walk	Green
	Don't Walk	Red
North Crosswalk	Walk	Blue
	Don't Walk	White w/Black Tracer
East Crosswalk	Walk	Green w/Black Tracer
	Don't Walk	Red w/Black Tracer
Neutral	---	White

Table 7.3
Vehicular Signal Head - Field Wiring Color Codes

Signal Display	Wire Color Per Approach
Thru R	Red
Thru Y	Orange
Thru G	Green
L/T ←R	Black
L/T ←Y	White w/Black Tracer
L/T ←G	Blue
R/T →R	Orange w/Black Tracer
R/T →Y	Red w/Black Tracer
R/T →G	Green w/Black Tracer
Neutral	White

7.5 Overhead Wiring

Overhead cable routing shall be designed to serve individual intersection components in a manner to minimize weight on the span, minimize the number of circuits originating from the control cabinet and take the most logical and direct route practical. The wiring diagram shall be drawn to graphically depict the desired wire routing needed to achieve these goals. See **Section 7.9, Figure 7.6** and **Figure 7.7** for wiring diagram requirements and examples.

When future signal devices are expected, cable for these future items (heads, loops, pushbuttons, etc.) shall be installed on the appropriate span and properly terminated without the need for future splicing.

7.5.1 Messenger Wire

All overhead cables shall be supported with messenger wire. Traffic signal cables shall be securely attached to the messenger wire via lashing rod. Over-lashing will not be permitted. Where new cables are added to existing spans, the existing lashing rod shall be removed and reused or replaced.

Fiber optic and traffic flow monitor cables shall be supported on dedicated messenger wire and shall not be lashed-in with signal cable on signal spans.

Attachment to traffic signal supports shall be per [City of Columbus Standard Construction Drawings 4330](#) and [4331](#).

Signal span messenger wire shall be sized according to [City of Columbus Standard Construction Drawing 4170](#). Interconnect messenger wire shall be ¼" diameter.

Attachment to private utility poles requires securing a permit from the pole owner. Pole attachment agreements/permits shall be acquired and furnished to the City of Columbus. The designer is responsible for coordinating with the utility pole owner and completing any attachment agreement forms, but only City personnel may sign forms.

7.5.2 Span Configuration

The configuration of the proposed span shall accommodate overhead utility clearance requirements as outlined in **Section 7.8**. Overhead wires may not block or partially block the view of any traffic signal head. Span configurations shall be in accordance with **Section 4.1.4.2**.

7.6 Underground Wiring

The traffic signal plan shall designate which cables are to be installed in individual conduits. Detailed callouts shall be used to specify the size of an individual conduit and which signal cables shall be installed in the referenced conduit. A separate group of callouts shall be furnished for each run of conduit. Examples of wire and conduit callouts are furnished in **Section 13.8.1**.

For new construction, cables shall be grouped together in separate conduits as illustrated in **Figure 7.5**. When only loop detector/pushbutton cable is used in a conduit run, the ground wire shall be placed in a separate conduit.

Figure 7.5
Cable Grouping In Conduit

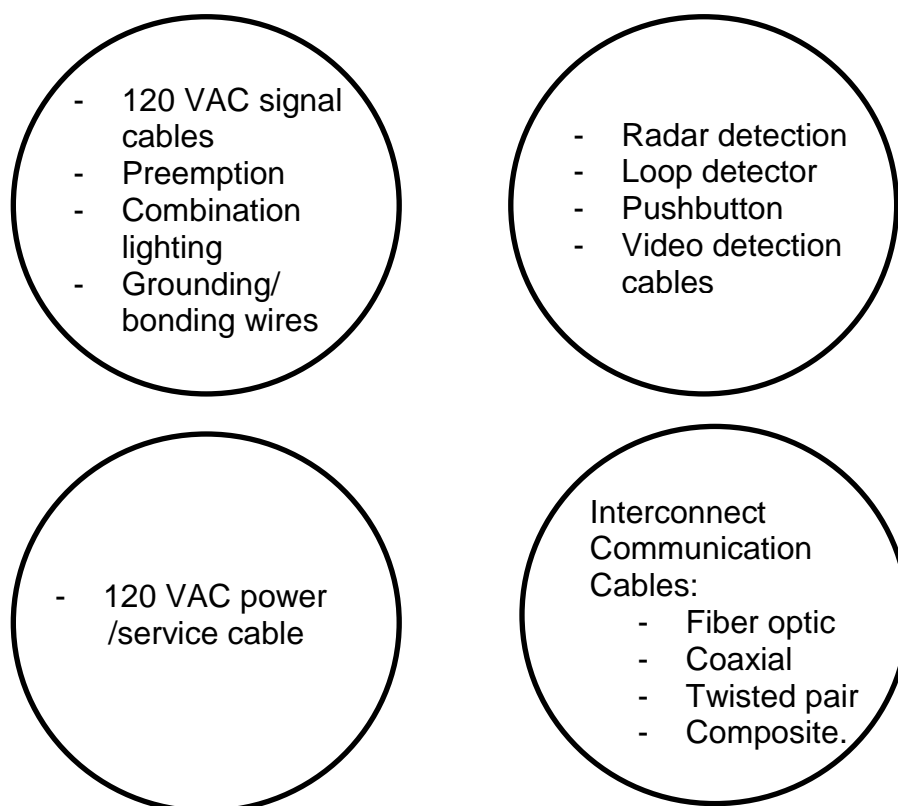

Only cables serving traffic signal elements mounted on a signal support shall enter the base/foundation of that structure. All other cables shall bypass the foundation. Traffic signal cable should not loop through a signal support structure when that cable does not serve devices on that support.

7.6.1 Cable Routing

Layout of the cable and conduit system for a mast arm traffic signal installation should be designed to cross the main street at only one location and each side street only once.

7.6.2 Conduit Fill

The maximum number of cables specified for an individual conduit shall conform to the conduit fill requirements outlined in **Section 13.2.2**.

Table 7.4 lists dimensions of underground traffic signal cable.

Table 7.4
Traffic Signal Cable Sizes

Wire	Conductors	Gauge (AWG)	Cross Section Area (in ²)
14 AWG Signal Cable/ IMSA 19-1 or 20-1	3/C	#14	0.13
	7/C	#14	0.22
	9/C	#14	0.33
	10/C	#14	0.36
RHH/RHW/USE: Power Cable, Ground Wire, or Lighting Wire	1/C	1/0	0.304
	1/C	#2	0.229
	1/C	#4	0.173
	1/C	#6	0.138
	1/C	#8	0.107
IMSA 50-2 Loop Detector Cable	2/C	#14	0.102
0.500 in. Underground Coax Trunk/Feeder Cable	1/C	#10	0.255
RG-6 Drop Cable	1/C	#18	0.058
RG-11 Drop Cable	1/C	#14	0.126
RG-6 with Power CCTV Cable	1/C 2/C	#18(Coax) #16 (Power)	0.16
CCTV Composite Cable (CAT 5e with power)	16/C	multiple	0.332
Radar Detection Cable	6/C	#22 (Comm.) #20 (Power)	0.132
IMSA 39-2 Video Detection Cable	3 Pair	#19 AWG	0.18
PE 39-BJFA Interconnect Cable	6 Pair	#19	0.322
Accessible Pedestrian Jumper Cable	4/C	#18	0.08
Fiber Optic Cable	24-Strand	---	0.45
	48-Strand	---	0.45
	72-Strand	---	0.45
	144-Strand	---	0.65
	288-Strand	---	0.75

7.7 Combination Lighting

Combination lighting and signal supports shall only be used in the downtown business district or at the direction of the City of Columbus, City Engineer or appointed designee.

When used, luminaires mounted on traffic signal supports shall be powered by the same power source used for the traffic signal installation. All combination lighting shall be routed through traffic signal conduit back to the traffic signal controller cabinet. Combination lighting wires shall not enter any adjacent street lighting conduit system. Conversely street lighting circuits shall not enter the traffic signal support, signal conduit system or the traffic signal cabinet. Adjacent street lighting systems and all combination traffic signal/lighting circuits shall remain separate at all times. See **Figure 7.7** for a wiring example.

Street lights mounted on traffic signal supports shall be controlled with a photocell. One photocell shall be used per intersection. The photocell shall be mounted on the signal support closest to the controller cabinet.

A remote current sensor shall not be used.

A separate circuit breaker shall be provided in the traffic signal cabinet for the combination lighting system.

7.8 Overhead clearances.

Aerial traffic signal cable and messenger wire shall maintain applicable clearances from other structures and other wires/conductors as listed in the [National Electrical Safety Code](#), [National Electrical Code](#) and the regulations published by the [Occupational Safety and Health Administration](#) (OSHA) addressing installation and maintenance tasks. Code references are listed in **Table 7.5**.

Table 7.5
Overhead Wires, Cables and Equipment Clearances

	National Electrical Safety Code Reference	National Electrical Code Reference
Vertical Clearance from: ground, road, rail, etc.	Section 232	225.18 230.24 230.26
Clearance between wires on different supporting structures	Section 233	N.A.
Clearances between wires on the same supporting structure	Section 235	225.14 800.44
Clearance of wires from adjacent structures. (Includes Light Poles and Buildings)	Section 234	225.19 230.24

- While section references listed in Table 7.5 are based on the 2020 National Electrical Code and the 2017 National Electrical Safety Code, the designer is required to reference the most recent publication of these documents.
- Individual railroad companies may have additional clearance requirements.

In addition to the requirements outlined in **Table 7.5**, the Designer shall also consider the regulations published in Part 1926 of the [29 CFR \(OSHA\) Safety and Health Regulations for Construction](#).

7.9 Intersection Wiring Plan Components

Plan details shall be furnished illustrating the number of conductors that will be routed to each item including, but not limited to: vehicular signal heads, pedestrian signal heads, pedestrian pushbuttons, loop detectors, preemption, illuminated signs, combination lighting and radar detection.

A wiring diagram shall be furnished, graphically depicting the wire routing and field orientation needed to accommodate the proposed conduit system/span layout and geographical location of each traffic signal element. An accompanying legend shall also be provided. Wiring diagram examples and suggested legend symbols are provided in **Figure 7.6** and **Figure 7.7**.

Figure 7.6
Intersection Wiring Diagram
With Loop Detectors

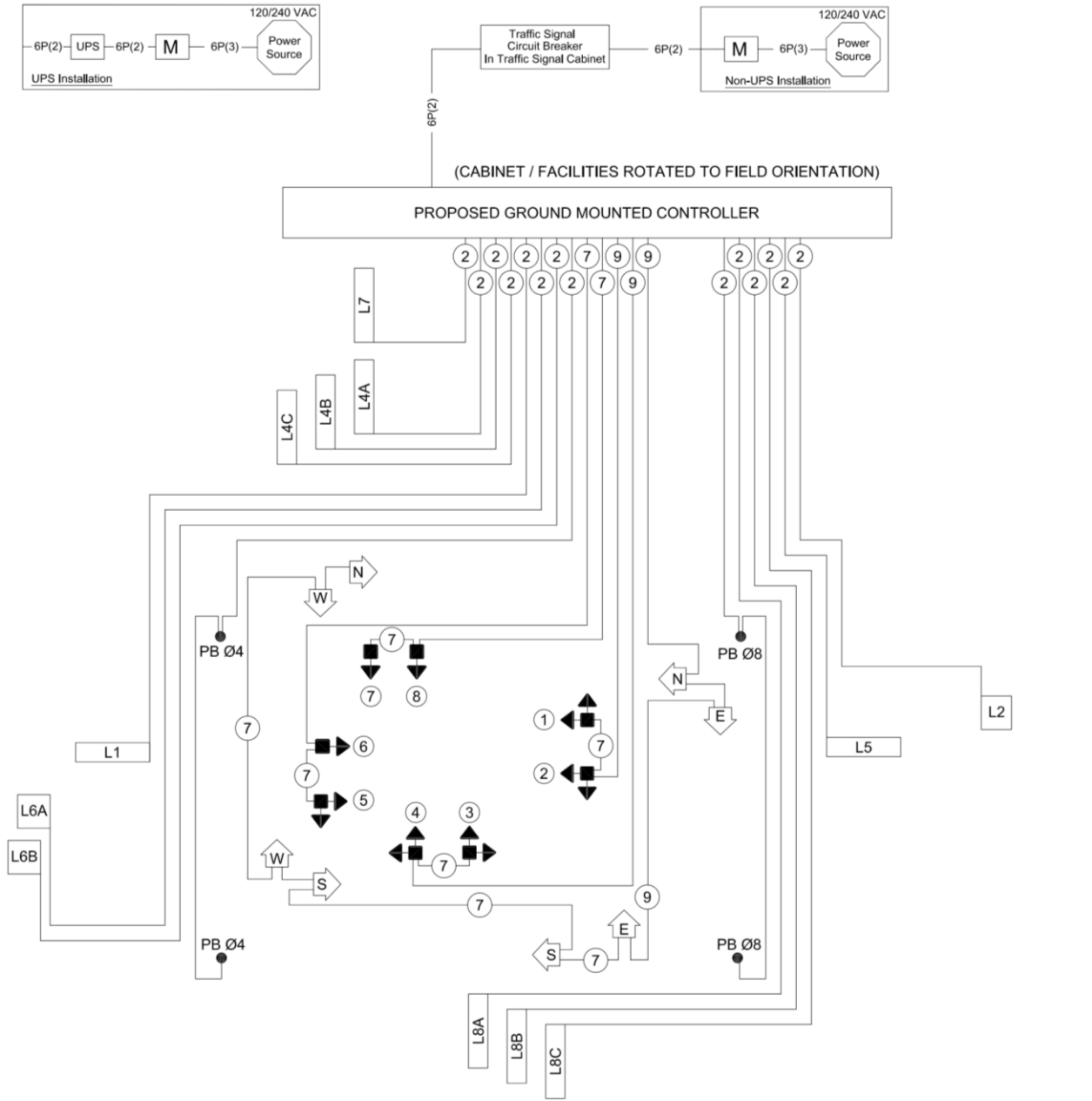

WIRING DIAGRAM LEGEND

- | | | | |
|------------|-------------------------------|-----------|---------------------------------|
| M | Power Meter Cabinet | LX | Detector Loop |
| UPS | Uninterruptible Power Supply | | 5-Section Vehicular Signal Head |
| — 6P(2) — | 2/C #6 AWG (Power) | | 3-Section Vehicular Signal Head |
| — 6P(3) — | 3/C #6 AWG (Power) | | Pedestrian Signal Head |
| (#) | Signal Cable, # of Conductors | | Pedestrian Pushbutton |

Figure 7.7
Intersection Wiring Diagram
With Radar Detection and Combination Lighting

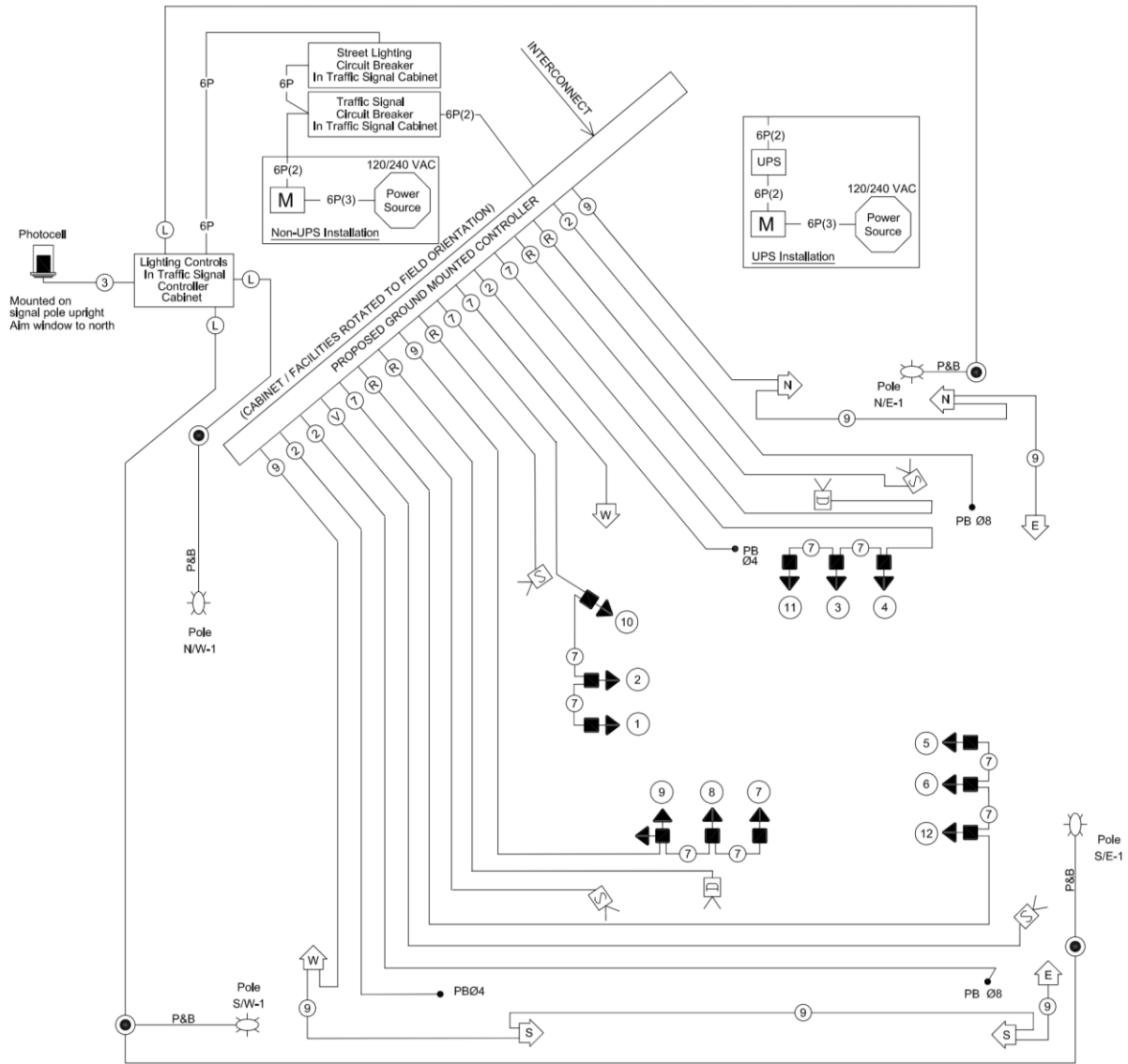

WIRING-DIAGRAM LEGEND

M	Power Meter Cabinet	UPS	Uninterruptible Power Supply	Ⓢ	Signal Cable, # of Conductors
— 6P(2) —	2/C #6 AWG (Power)	E	Pedestrian Signal Head	— R —	Radar Detection Cable
— 6P(3) —	3/C #6 AWG (Power)	5-Section Vehicular Signal Head		>S	Stop Line Radar Unit
— P&B —	(2) - #10 AWG Pole and Bracket Cables	3-Section Vehicular Signal Head		>D	Dilemma Zone Radar Unit
— L —	Distribution Cable #8 AWG (2 Wire)	• PB	Pedestrian Pushbutton		
●	Connection of Distribution Cable to Pole and Bracket Arm Connector Kit Fused and Unfused.	Luminaire, (Type)			

CHAPTER 8: TRAFFIC SIGNAL SIGNS

8.1 General

All sign legends, colors and sizes shall conform to the requirements of the latest edition of the [Ohio Manual of Uniform Traffic Control Devices](#) as well as City of Columbus signing requirements.

8.2 Material Specifications

Signs shall be in accordance with 630 and 730 of the current version of the [City of Columbus Construction and Material Specifications](#).

8.3 Sign Mounting

8.3.1 Strain Pole and Signal Support Mounted Signs

With the exception of pedestrian pushbutton signs, signs mounted on strain poles or the vertical portion of signal supports shall have a minimum mounting height of 7 ft. (measured from the pedestrian path to the bottom of the sign). Mounting details shall be consistent with the requirements outlined in [City of Columbus Standard Construction Drawing 4253](#).

8.3.2 Mast Arm Mounted Signs

Mast arm mounted signs shall have a minimum mounting height of 16.5 ft. (17 ft. preferred) above the roadway surface (measured to the bottom of the sign) and shall be mounted per the details provided in [City of Columbus Standard Construction Drawings 4251 and 4252](#).

For free swinging signs, a minimum of 2 sign hanger assemblies shall be used for each mast arm mounted sign, unless otherwise directed by the City.

8.3.3 Span Wire Mounted

Span wire mounted signs shall have a minimum mounting height of 16.5 ft. (17 ft. preferred) above the roadway surface (measured to the bottom of the sign) and shall be mounted per the details provided in [City of Columbus Standard Construction Drawing 4250](#).

A minimum of 2 sign hanger assemblies shall be used for each sign, unless otherwise directed by the City.

8.4 Signs for New or Modified Traffic Signals

Temporary signage shall be included in the plan when a signal is installed at a previously unsignalized intersection or when the phasing of an existing traffic signal is modified.

8.4.1 New Signal Installation

W3-3 "Signal Ahead" sign and W16-15P "New" supplemental plaque shall be installed on the major street. Use of these signs on the minor street is optional or as directed. These signs shall be placed a distance from the stop line equal to approximately 10 times (measured in feet) the posted speed limit (in MPH). However, the "Signal Ahead" sign with "New" supplemental plaque shall not be placed beyond an adjacent signalized intersection. These signs should be placed on existing poles when available. Signage should not be placed greater than 12 ft. from the edge of pavement.

Figure 8.1
Signs, As Per Plan

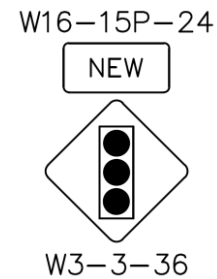

8.4.2 Modified Signal Phasing Application

When phases are added or modified at an existing signalized intersection, the W23-H2b "Signal Operation Changed" signs should be positioned to be visible to approaching traffic and shall be placed on each leg of an intersection.

Figure 8.2
Signs, As Per Plan

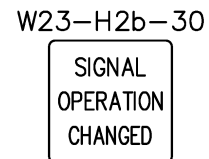

8.5 Left (Right) On Green Arrow Only (R10-5)

The Left On Green Arrow Only sign (R10-5L, 30 in. x 36 in.) may be used where traffic signal heads control exclusive left turn movements (protected only phasing) for a single left turn lane. *This sign shall only be used when directed by the City.* The sign may be beneficial in certain situations such as a change from permissive or protected/permissive left turn phasing to protected only phasing, or to address a driver compliance or crash problem. If used, the sign shall be mounted 3 ft. to the right of a 3-section left turn signal head (measured center-to-center).

Figure 8.3
Left/Right On Green Arrow Only

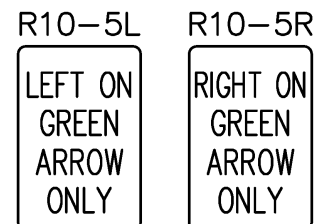

The Right On Green Arrow Only sign (R10-5R, 30 in. x 36 in.) shall be used where traffic signal heads control exclusive right turn movements (protected and/or right turn overlap phasing) and the red section of the signal head displays a red arrow. For a single right turn lane, the sign shall be mounted 3 ft. to the left of a 3-section right turn signal head (measured center-to-center). For dual right turn lanes, the sign shall be centered between the 3-section right turn signal heads. For additional placement details, see **Chapter 5**.

8.6 Right Turn Signal (R10-10R)

The Right Turn Signal sign (R10-10R, 30 in. x 36 in.) shall be used where traffic signal heads control exclusive right turn movements (protected and/or right turn overlap phasing) and the red section of the signal head displays a circular red indication (to permit right turn on red after stop). For a single right turn lane, the sign shall be mounted 3 ft. to the left of a 3-section right turn signal head (measured center-to-center). For dual right turn lanes, the sign shall be centered between the 3-section right turn signal heads. For additional placement details, see **Chapter 5**.

Figure 8.4
Right Turn Signal

R10-10R



8.7 No Left Turn (R3-2) / No Right Turn (R3-1)

No Left Turn or No Right Turn signs (24 in. x 24 in. or 36 in. x 36 in., see OMUTCD) shall be placed overhead on mast arms or span wire to indicate turn prohibitions. When used, the signs shall be mounted 3 ft. to the left of the left-most signal head for R3-2 or 3 ft. to the right of the right-most signal head for R3-1. The 3 ft. of separation shall be measured from the center of the sign to the center of the vehicular signal head.

Figure 8.5
No Left/Right Turns

R3-2



R3-1



8.8 One Way (R6-2)

A One Way sign (24 in. x 30 in. or 30 in. x 36 in., see OMUTCD) shall be used overhead as a supplemental sign to the ground mounted One Way signs at a signalized intersection of one or more one-way streets. The sign should be mounted adjacent to the applicable signal head, 3 ft. to the left of the left-most head for R6-2R and 3 ft. to the right of the right-most head for R6-2L. The 3 ft. of separation shall be measured from the center of the sign to the center of the vehicular signal head.

Figure 8.6
One Way

R6-2L



R6-2R



8.9 Begin/End One Way (R6-6, R6-7)

Begin One-Way (R6-6) or End One-Way signs (R6-7) (24 in. x 30 in. or 30 in. x 36 in., see OMUTCD) shall be used overhead to supplement ground mounted one way signage at a signalized intersection where a one-way street transitions to/from a two-way street. For example, at an intersection where the east leg allows for travel in both the eastbound and westbound directions, but the west leg is one-way eastbound, the R6-7 sign shall be mounted overhead facing the eastbound traffic coming from the west leg of the intersection. The sign should be positioned to be visible to approaching traffic for the applicable approaches, preferably centered on the approach.

Figure 8.7
Begin/End One Way

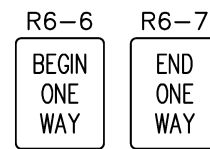

8.10 No Turn on Red (R10-11b, R10-11c, CM-R10-11c)

The No Turn on Red sign (R10-11b) may be used when an engineering study finds that one or more of the following conditions exists:

- Sight distance to vehicles approaching the intersection is inadequate as defined in Section 201.3 (Intersection Sight Distance) of the [Location and Design Manual, Volume 1](#), (L&Dv1) (Ohio Department of Transportation).
- The intersection area has geometric or operational characteristics which may result in unexpected conflicts.
- Significant pedestrian-vehicle conflicts are resulting from right or left turn on turn on red (RTOR / LTOR) movements.
- More than 3 RTOR (LTOR) crashes per year have been identified for the particular approach.
- There is significant crossing activity by elderly and/or mobility impaired.
- At major schools, defined by 20 students per 30 minute crossing period (then day and time restrictions apply).

Figure 8.8
No Turn On Red

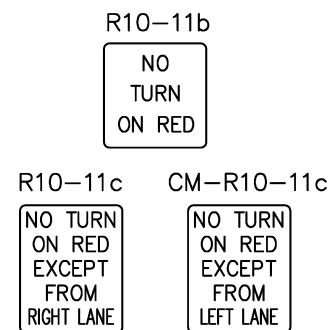

The sign shall be placed adjacent to the appropriate signal head, 3 ft. to the right of the right-most head and 3 ft. to the left of the left-most head (whichever is applicable, measured center of sign to center of head).

The No Turn on Red Except (Right, Left) Lane signs (R-10-11c, CM-R-10-11c) shall be used at approaches with more than one right/left turn lane and is placed:

- 3 ft. to the left of the right signal head for R-10-11c
- 3 ft. to the right of the left signal head for CMR-10-11c

(both cases are measured center of sign to center of head)

8.11 Stop Here on Red (R10-6)

A Stop Here on Red (24 in. x 36 in.) may be used to indicate to drivers the appropriate location to stop for actuating the signal when the front edge of the detector (with either timed delay and/or in non-lock mode) is more than 15 ft. from the curb line extension. See **Chapter 9** for additional details.

Figure 8.9
Stop Here On Red
R10-6



The sign post should be centered on the stop line and placed as close as possible to 3 ft. behind the curb or 6 ft. off of the edge of pavement.

8.12 No Ped Crossing (R9-3) and Use Crosswalk (R9-3bP)

The No Ped Crossing sign (24 in. x 24 in.) shall be used at corners of intersections where pedestrian crossings are prohibited. The signs shall be placed at the opposite side of the street and facing the pedestrian where they would normally attempt to cross.

If a crossing exists at another leg of the intersection, or at an adjacent intersection, the “Use Crosswalk” R9-3bP (18 in. x 12 in.) plaque shall be placed under the No Ped Crossing sign and shall have an arrow directing pedestrians to the nearest crossing.

Figure 8.10
No Ped Crossing Signs

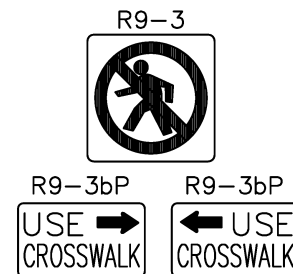

8.13 Pedestrian Pushbutton Signs (R10-3a(R) and R10-3a(L))

Applications of pedestrian pushbutton signs are detailed in **Chapter 6**.

8.14 Bicycle Signal Actuation (R10-22)

Bicycle actuation signs R10-22 (12 in. x 18 in.) should be used to supplement bicycle detector markings that identify the location where a bicyclist is to be positioned to actuate a traffic signal.

Figure 8.11
Bicycle Actuation

R10-22



8.15 LED “Blank-out” Signs

Blank-out signs may be used instead of static signs with approval from the City of Columbus, City Engineer or appointed designee. Application examples include turn prohibitions (NO TURN ON RED) and vehicle preference (BUS LANE) that are effective only at certain times during the day or during one or more portions of a particular traffic signal cycle. The sign shall be placed over or adjacent to the appropriate lane without interfering with the signal heads.

8.16 Turning Vehicles Yield To Pedestrians (R10-15)

Turning Traffic Yield To Pedestrians signs (R-10-15-30) (30 in. x 30 in.) shall only be used when an intersection has a documented vehicle-pedestrian crash history of one or more over a three year period or if the intersection has a unique geometry that may cause a driver to not see pedestrians in the crosswalk.

Figure 8.12
Turning Vehicles Yield To Pedestrians

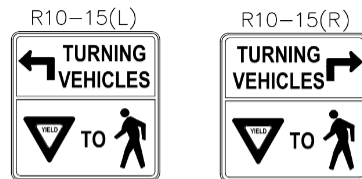

The sign shall be mounted overhead 3’ to the left of the left-most head for the R10-15(L) or 3’ to the right of the right most head for the R10-15(R). When used, the R10-15 (no arrow) sign shall be centered as much as possible over the approach lanes so that it is within the view of both left- and right-turning motorists, and shall be placed no closer than 3’ from the nearest signal head.

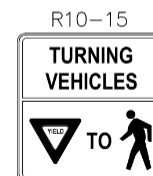

CHAPTER 9: VEHICLE DETECTION

9.1 Vehicle Detection

Vehicle detection shall comply with the material requirements and installation methods outlined in Sections 632 and 732 of the current version of the [City of Columbus Construction and Material Specifications](#).

Materials shall also be in accordance with the City of Columbus [Qualified Products List](#).

Loop detector, detection zone, and detection area terms have all been used to describe vehicle detection components detailed within. The term “loop” is in reference to an inductive loop, “detection zone” references a detection method other than inductive loop detection application and “detection area” is used when referencing to either a loop or a detection zone.

9.2 Vehicle Detection Types

9.2.1 Radar Detection

Radar detection is the City’s preferred method for vehicle detection and should be used when practical.

Radar detection shall also be used for the following applications:

- Detection located on a bridge deck or bridge approach slab.
- Detection located in brick areas.
- Detection that spans a joint between different pavement compositions.
- Detection in paved areas with less than 6.0 in. of total pavement composition (asphalt or concrete).

9.2.2 Video Detection

Video detection is an alternate method for vehicle detection and should be used for permanent detection only when directed by the City. The City may elect to use video to maintain consistency in detection type at intersections being modified, or where radar detection is not feasible.

Video detection can be used for the same applications as stated above for radar detection.

Video detection may also be used at the contractor's discretion for temporary detection in maintenance of traffic setups.

9.2.3 Inductive Loop Detection

Inductive loop detection may be used for the following applications:

- At new signalized intersections when the use of radar or video detection is not required as outlined above.
- Modification to an existing signalized intersection where loops already exist.

9.3 Vehicle Detection Application

9.3.1 Radar Detector Mounting

Radar detectors shall be mounted on the upright of a mast arm signal support or strain pole, the arm portion of a mast arm support, or in some instances an aluminum truss-type bracket arm.

The radar detector location and mounting height shall be designed to prevent visual obstructions caused by adjacent or leading vehicles. The preferred mounting locations differ based on the type of detection (stop line or dilemma zone detection) and are discussed in the following sections.

9.3.1.1 Stop Line Detector

Stop line radar detectors have a pie-shaped, 90-degree field of view with a 140-foot range. In many instances, the stop line radar unit should be able to be programmed for both stop line detection areas and advanced detection areas on low-speed mainline streets. (See **Sections 9.3.6** through **9.3.8**.) Stop line detector units shall be mounted in one of three locations as described below and as depicted in **Figures 9.1** through **9.3**.

Preferred Mounting Location: Near left signal support (upright)
 Alternate Mounting Location 1: Back side of near left mast arm
 Alternate Mounting Location 2: Near right signal support (upright)

Examples of stop line radar detector placement for a full intersection are provided in **Figure 9.4** and **Figure 9.5**.

The radar units mounted on signal support uprights shall be mounted at approximately 18 feet to 20 feet above the base of the support.

Radar unit cables shall enter mast arm supports via a field-drilled hole protected by a grommet. Cables for radar units mounted on strain poles shall enter the pole with other signal cables via a weatherhead.

For strain pole installations where the Preferred Mounting Location or Alternate Mounting Location 2 does not permit the required detection areas to be within the unit's field of view (typically at larger intersections), stop line radar detectors shall be mounted on bracket arms as shown in **Figure 9.6**. If used, bracket arms shall be 25 ft. or 30 ft. in length, consistent with the details furnished on the [City of Columbus Standard Construction Drawing 4110](#).

FIGURE 9.1
Stop Line Detector Placement
Preferred Location

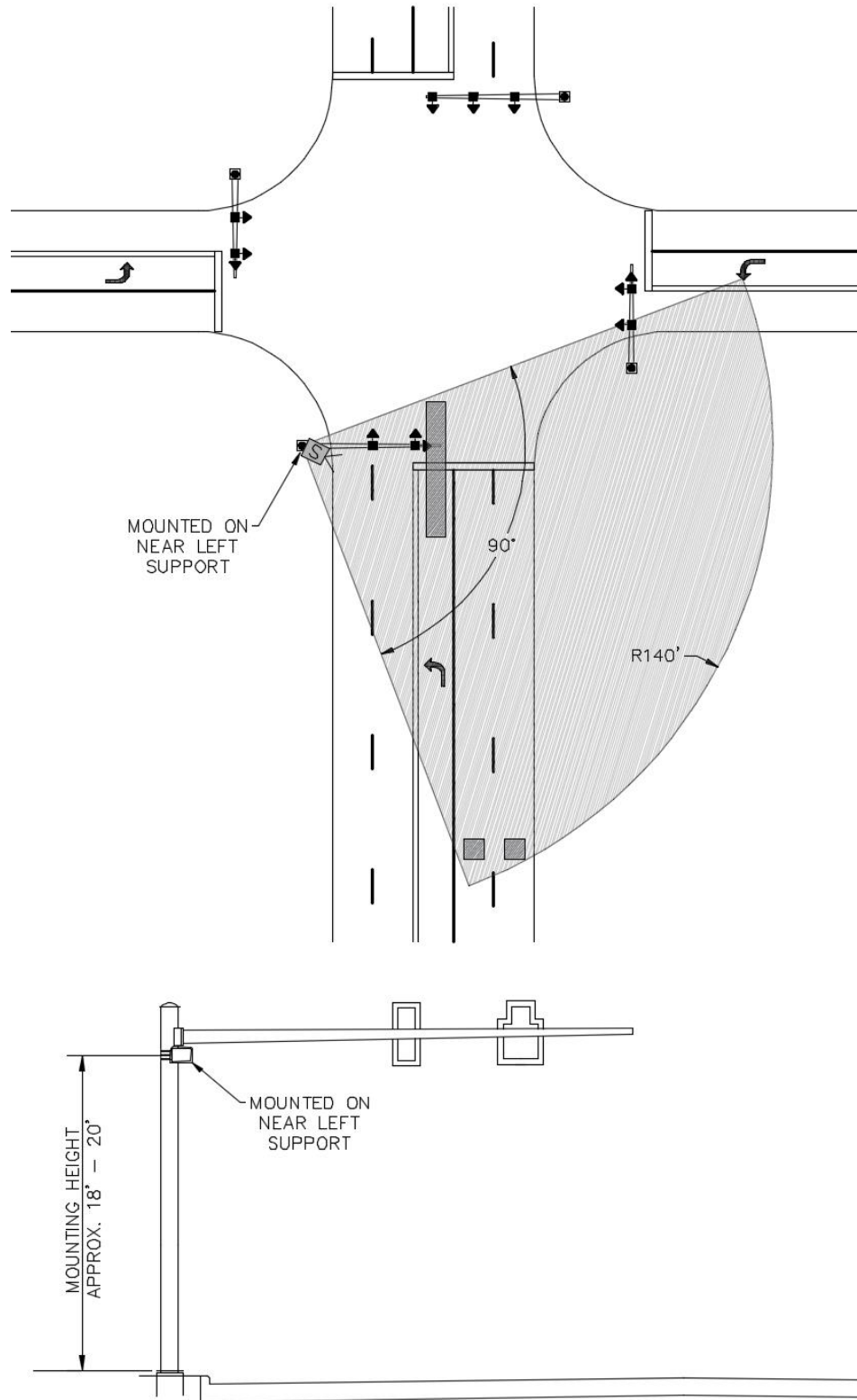

FIGURE 9.2
Stop Line Detector Placement
Alternate Location 1

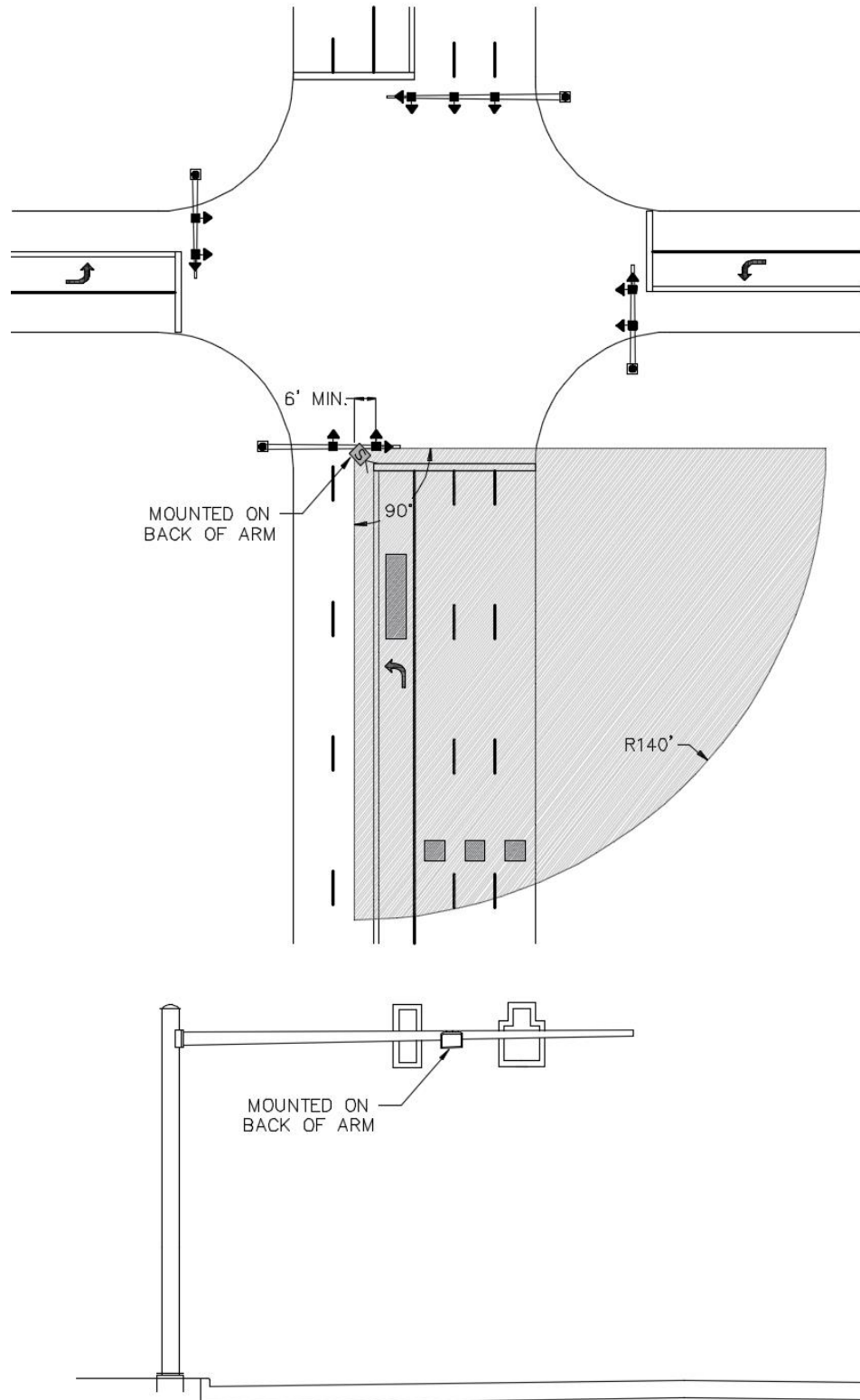

FIGURE 9.3
Stop Line Detector Placement
Alternate Location 2

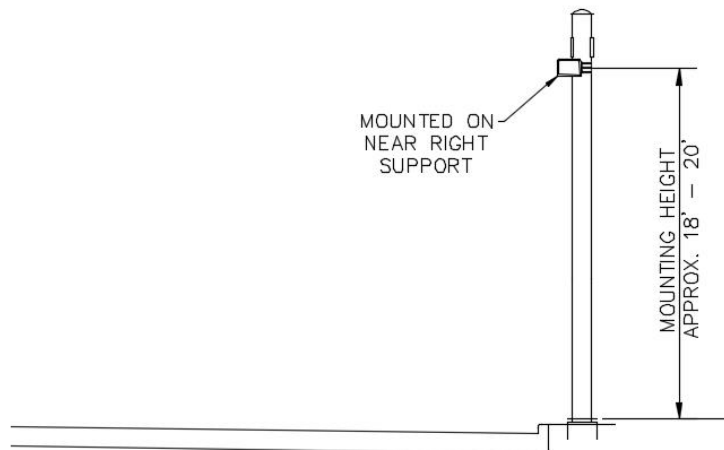
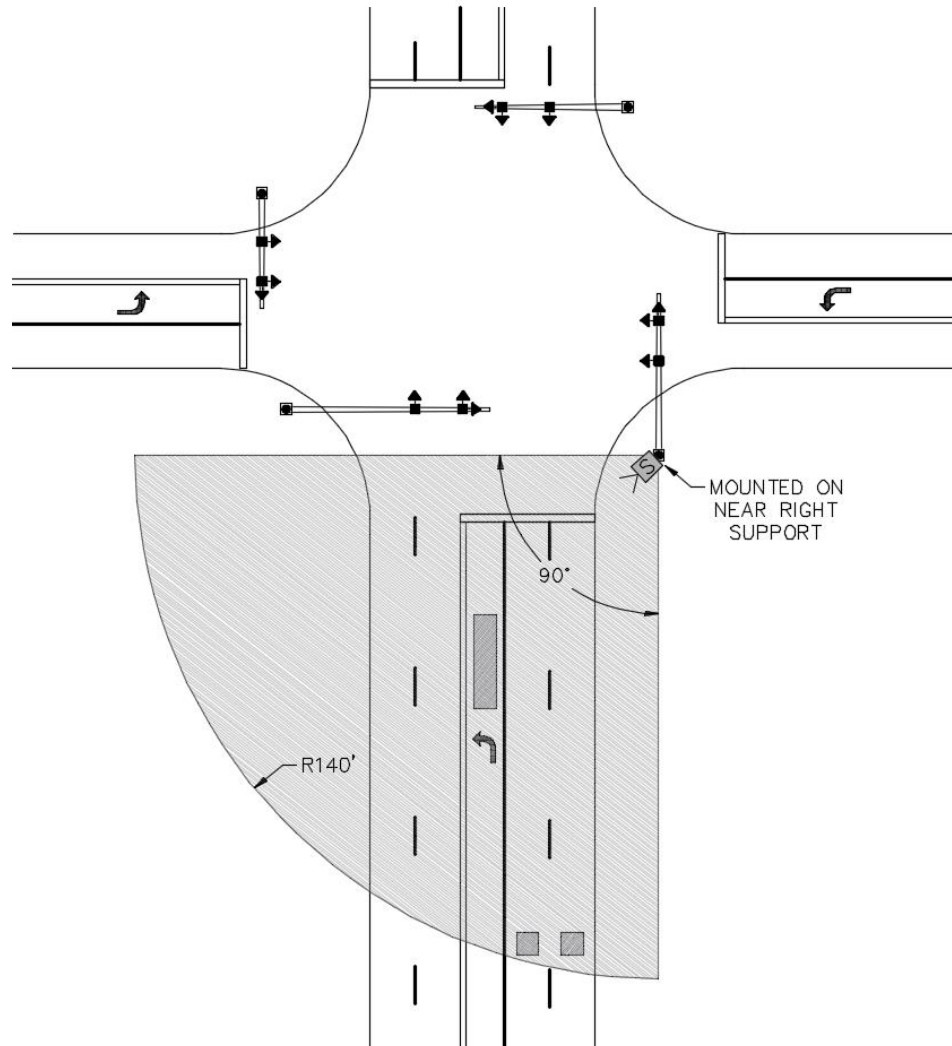

FIGURE 9.4
Stop Line Detector Placement
Example Mast Arm Intersection Layout
(Low Speed, 35 MPH or Less)

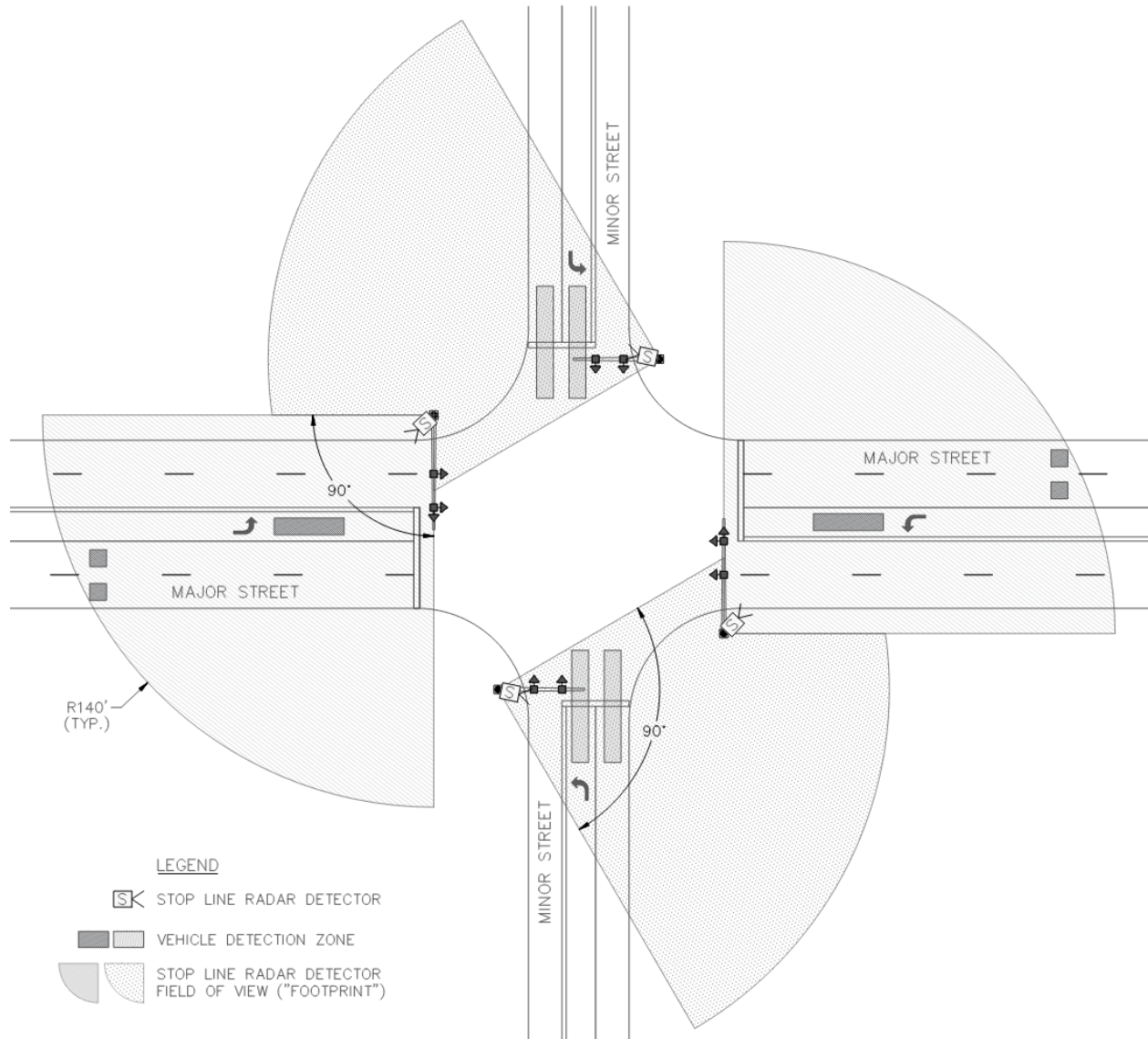

FIGURE 9.5
Stop Line Detector Placement
Example Strain Pole Intersection Layout
(Low Speed, 35 MPH or Less)

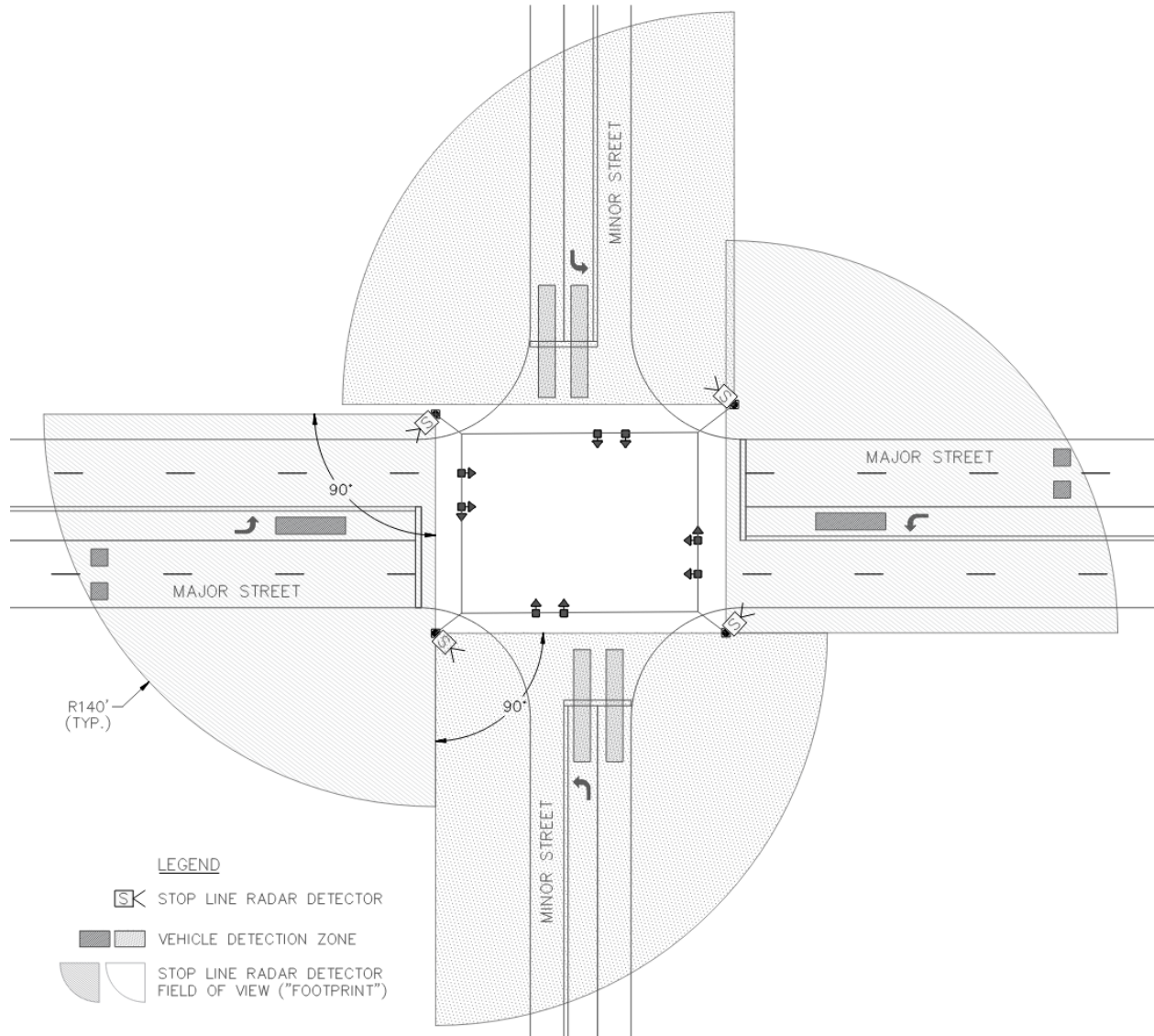
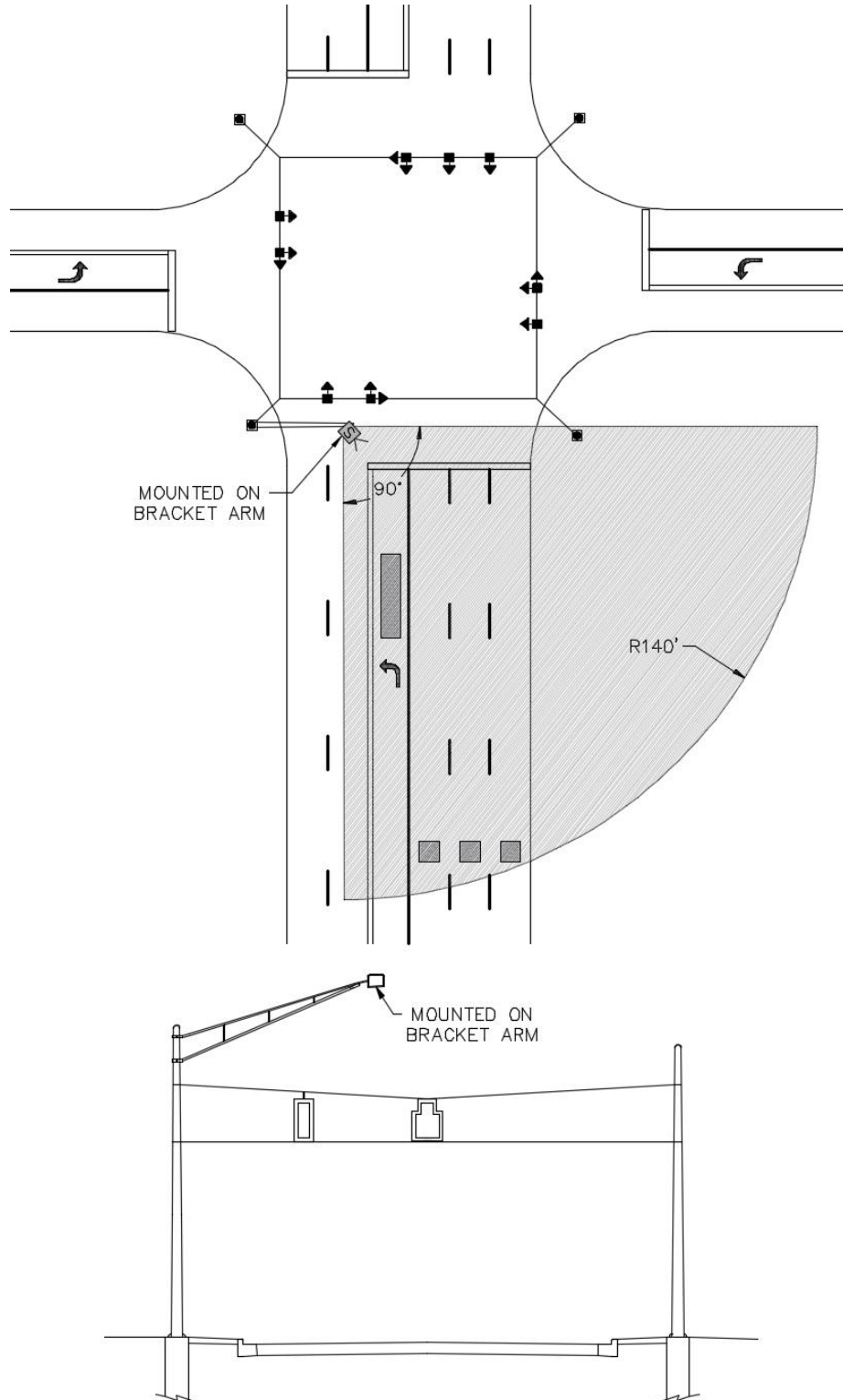

FIGURE 9.6
Stop Line Detector Placement
Strain Pole Installation
Multi-Lane Approach



9.3.1.2 Dilemma Zone Detector

The dilemma zone radar unit is programmed to track approaching vehicles in the through lanes from entry into the unit's field of view until the vehicles reach the stop line. As shown in **Figure 9.7**, dilemma zone radar detectors have an elongated oval shape to their field of view and have a range of approximately 600 feet. Dilemma zone radar units do not use square detection areas for dilemma zones like video detection and loops. See **Section 9.3.9** for further information related to dilemma zone detection.

FIGURE 9.7
Stop Line and Dilemma Zone Detector Placement
Example Intersection Layout
(40 MPH or Greater)

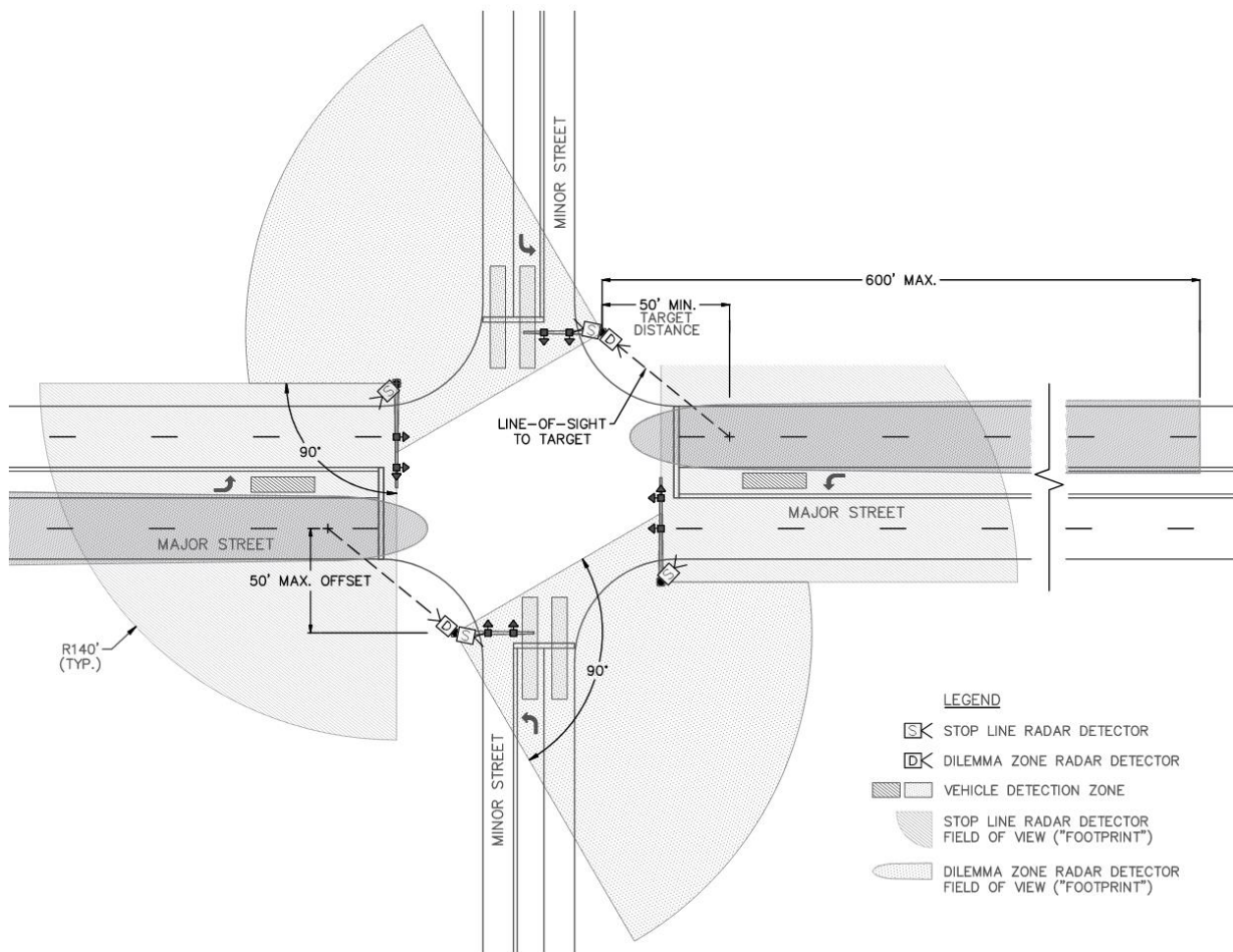

The preferred mounting location for dilemma zone detector units shall be on the signal support on the near right corner of the subject approach to the intersection as shown in **Figures 9.7 and 9.8**.

The dilemma zone radar units mounted on signal support uprights shall be mounted at approximately 18 feet to 20 feet above the base of the support.

Radar unit cables shall enter mast arm supports via a field-drilled hole protected by a grommet. Cables for radar units mounted on strain poles shall enter the pole with other signal cables via a weatherhead.

For near-right supports that are offset greater than 50 feet from the center of the approaching through lanes, or if an obstruction to the radar unit's line of sight exists, dilemma zone radar detectors shall be mounted on the back of the near left corner mast arm as shown in **Figure 9.9** or, for strain pole installations, on a bracket arm as shown in **Figure 9.10**. If used, bracket arms shall be 25 ft. or 30 ft. in length, consistent with the details furnished on the [City of Columbus Standard Construction Drawing 4110](#).

Dilemma zone radar units may be span-mounted if the near right support or bracket arm placement options are not feasible. When span-mounted, radar units shall be tethered. Use of span-mounted radar units requires approval from the City of Columbus, City Engineer or appointed designee.

FIGURE 9.8
Dilemma Zone Detector Placement
Preferred Mounting Location

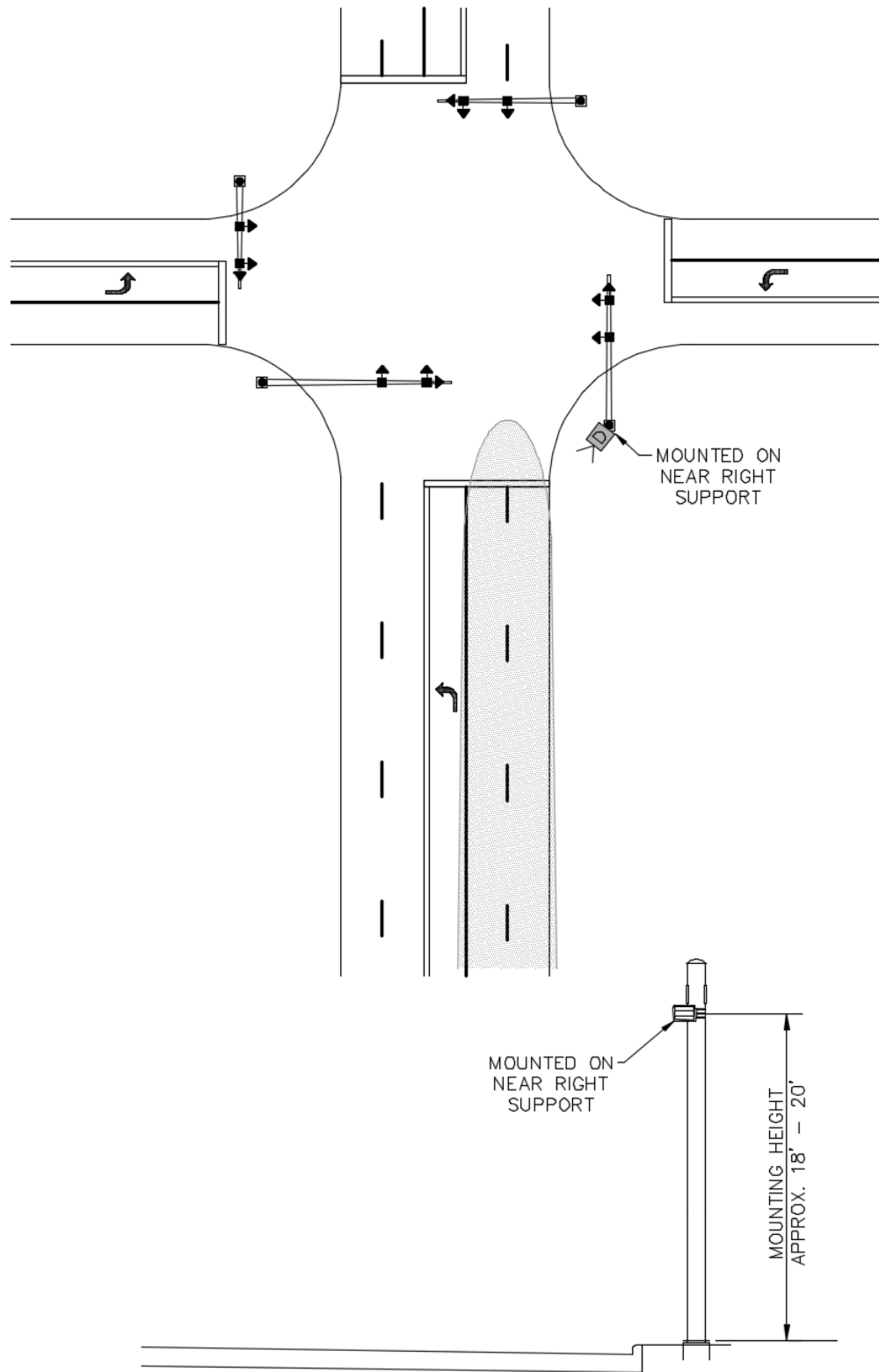

FIGURE 9.9
Dilemma Zone Detector Placement
Alternate Mounting Location – Mast Arm

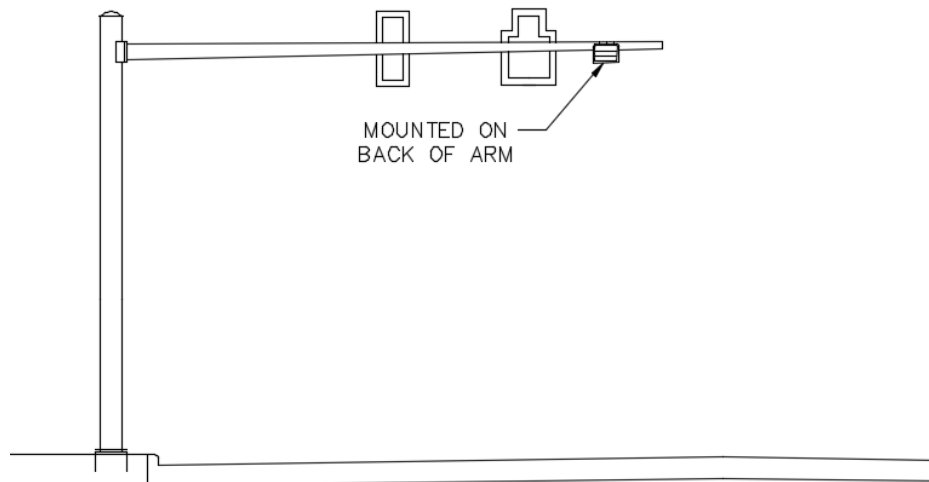
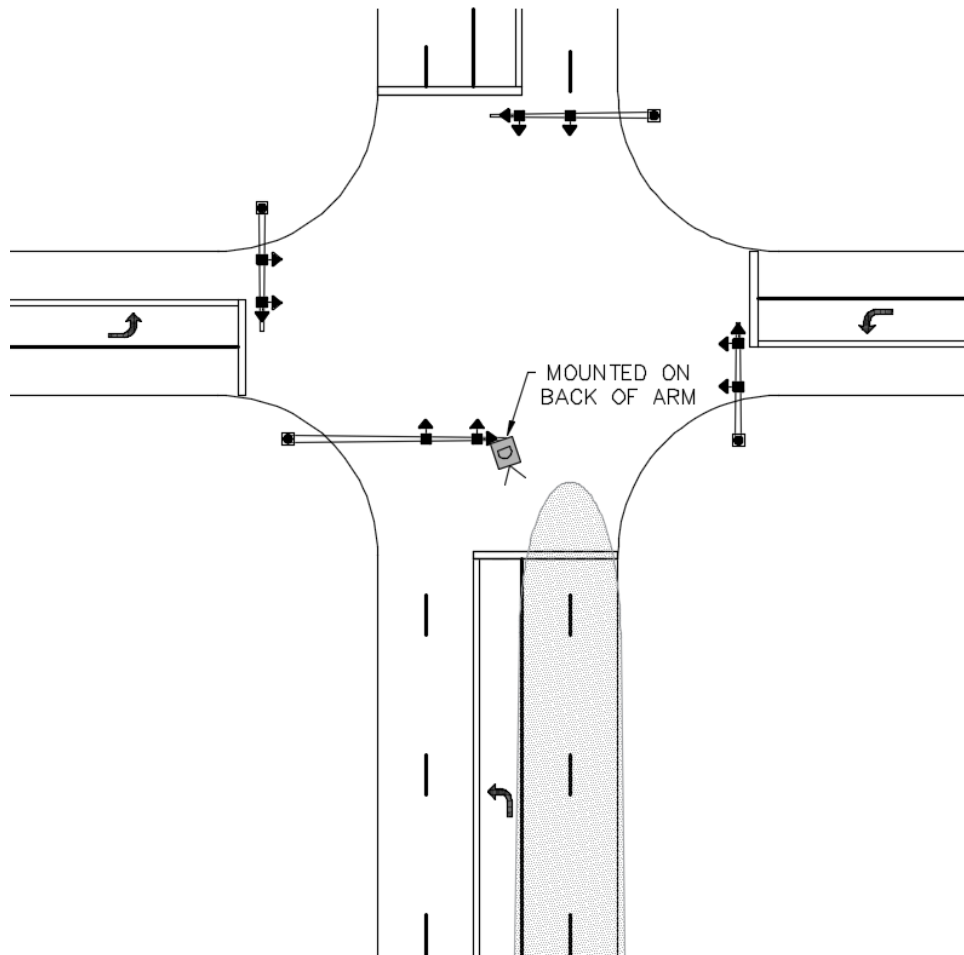
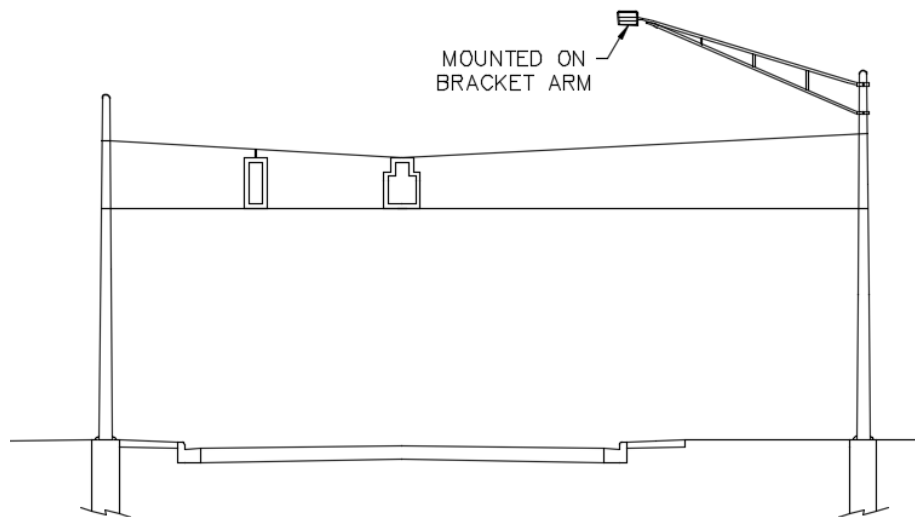
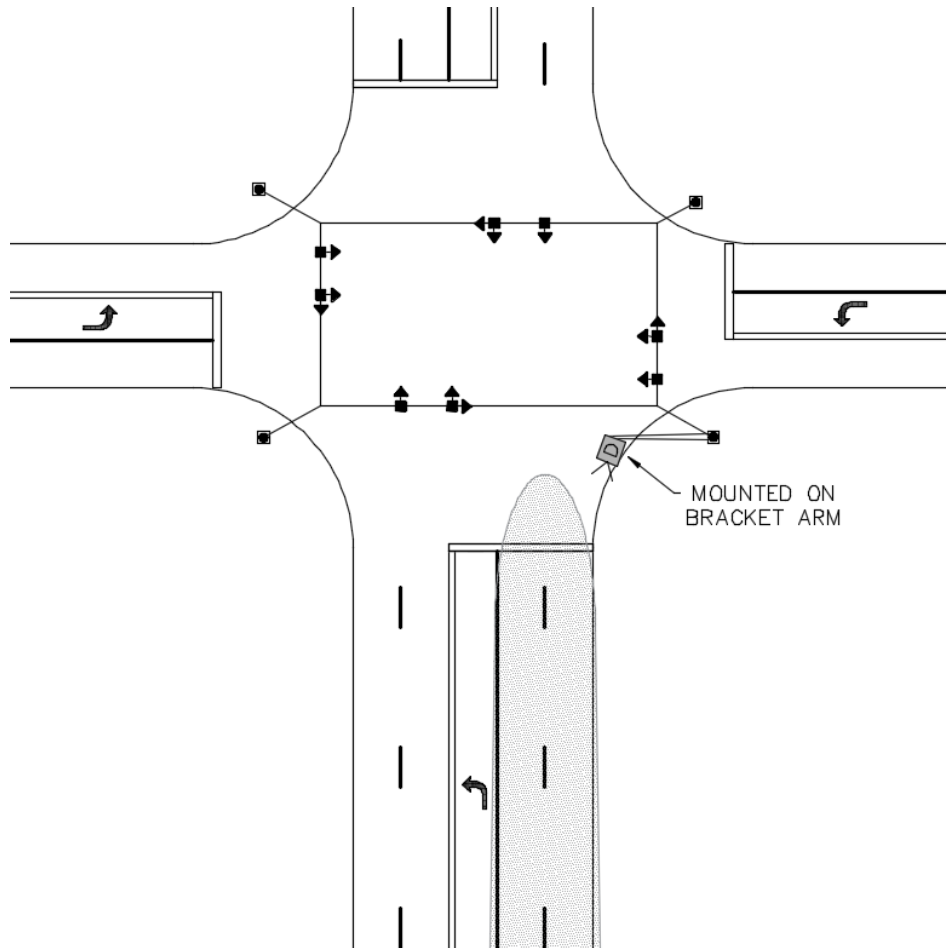

FIGURE 9.10
Dilemma Zone Detector Placement
Alternate Mounting Location – Bracket Arm



9.3.2 Video Detector Mounting

Video detectors shall be mounted on an aluminum truss-type bracket arm unless otherwise approved by the City of Columbus, City Engineer or appointed designee. Bracket arms shall be 25 ft. or 30 ft. in length, consistent with the details furnished on the [City of Columbus Standard Construction Drawing 4110](#).

The video detector location and mounting height shall be designed to prevent visual obstructions caused by adjacent vehicles. The preferred mounting location is on the opposite side of the cross street facing approaching traffic.

9.3.3 Inductive Loop Installation

The loop cable may emerge from the loop at either a corner or perpendicular from the side. If multiple loops are used, the loop lead tails may not cross or otherwise conflict with an adjacent loop. The saw slots must maintain a minimum 1 ft. separation between loop tails to the pull box. The loop(s) and associated pull box shall be positioned to minimize the distance between them. When two or more loops are installed on an approach, each set of loop wires shall be in separate slots. [City of Columbus Standard Construction Drawing 4300](#) provides installation details.

Presence loops shall have 3 turns and advance/dilemma zone loops shall have 4 turns.

Loop wires shall not cross a concrete/asphalt/brick boundary such as a bus pad/roadway, private drive/approach area or any other location with a pavement transition. The loop wires shall be entirely contained within one type of pavement material. If this cannot be achieved, the use of radar or video detection shall be required.

Quadrupole loop design shall be used when the width of the loop detector ranges between 6 ft. and 10 ft. The maximum quadrupole loop width is 10 ft. (5 ft. x 5 ft.). If a wider loop is needed, 2 separate loops shall be used in lieu of a quadrupole loop.

Each loop shall be placed on a separate detector channel and have its own lead-in cable.

Inductive loops shall maintain a minimum of 1 ft. separation from obstructions in the lane including water valves, sewer manhole lids, pull box lids, etc.

9.3.4 Vehicle Detection Area

9.3.4.1 Presence Detection

Presence detection widths shall be as listed in **Table 9.1**. Maximum loop width for a non-quadrupole loop is 6 ft. The maximum loop width for a quadrupole loop is 10 ft.

Detection areas shall be centered in the lane and maintain a minimum of 2.5 ft. from an adjacent lane to avoid false calls.

Table 9.1
Presence Detection Width

Lane Width "w" (ft.)	Presence Detection Width (ft.) (Loop)	Presence Detection Width (ft.) (Zone)
$10 \leq w < 11$	5.0	5.0
$11 \leq w < 12$	5.5	5.5
$12 \leq w < 13$	6.0	6.0
$13 \leq w < 14$	3.5 - 3.5 (Q)	7.0
$14 \leq w < 15$	4.0 - 4.0 (Q)	8.0
$15 \leq w < 16$	4.5 - 4.5 (Q)	9.0
$16 \leq w < 17$	5.0 - 5.0 (Q)	10.0
$w \geq 17$	Use Two Loops	Use Two Zones

(Q) = Quadrupole loop

The detection area should extend to within 15 ft. of the crossing street's extension of the face of curb/edge line as illustrated in **Figures 9.11 to 9.14**. However, a maximum inductive loop length of 39 ft. and detection zone length of 40 ft. shall be maintained. In order to accommodate unique intersection geometry and maintain 20 ft. behind the stop line, the 15 ft. buffer may be increased.

9.3.4.2 Advanced and Dilemma Zone Detection

Advanced detection shall be provided with square/rectangular detection areas. The dimension of the area shall be as specified in **Table 9.2**.

Table 9.2
Advanced Detection Size

Lane Width "w" (ft.)	Detection Area Length x Width (ft.)
$10 \leq w < 11$	5.0 x 5.0
$11 \leq w < 12$	5.5 x 5.5
$12 \leq w < 13$	6.0 x 6.0
$13 \leq w < 14$	6.0 x 7.0
$14 \leq w < 15$	6.0 x 8.0
$15 \leq w < 16$	6.0 x 9.0
$16 \leq w < 17$	6.0 x 10.0
$w \geq 17$	Use Two Areas

Detection areas shall be centered in the lane and maintain a minimum of 2.5 ft. from an adjacent lane to avoid false calls.

Dilemma zone detection shall also use square/rectangular detection areas, but only when video detection or inductive loops are used. In those cases, the dimension of the detection area shall be as specified above in **Table 9.2**. Radar detection technology does not use square/rectangular detection areas; radar provides dilemma zone protection by tracking vehicles as they approach the stop line. See **Section 9.3.9** for details on dilemma zone detection using radar.

9.3.5 Vehicle Detection Delay Settings

Delay settings for individual detection areas shall be specified to prevent false calls for an individual phase and to minimize calling a side street phase for right turn on red traffic. **Table 9.3** summarizes typical delay settings. Delay is set on the loop detector unit for an inductive loop and in the controller for radar and video detection.

Table 9.3
Recommended Detector Delay Settings

	Detector Delay Setting (Sec.)
Exclusive right turn lane	12
Shared through/right lane	5-8
Exclusive through lane	0
Exclusive through lane (adjacent to opposing lane of traffic)	3
Shared through/left lane (adjacent to median)	0
Shared through/left lane (adjacent to opposing lane of traffic)	3
Exclusive left turn lane (adjacent to median)	0
Exclusive left turn lane (adjacent to opposing lane of traffic)	3
2nd car left turn phase detection	3
Advanced detection	0
Dilemma zone detection	0

9.3.6 Side Street Detection

Presence detection for side streets shall be set to “Non-Lock”.

Detection areas shall extend from a point 20 ft. behind the stop line to a point to within 15 ft. of the extension of the cross street edge of pavement/face of curb. **Figures 9.11, 9.12 and 9.13** illustrate side street detection area requirements. If the 15 ft. distance between the curb line or edge of pavement and the front of a detection area cannot be maintained, a R10-6 (STOP HERE ON RED) sign may be used with approval from the City of Columbus, City Engineer or appointed designee. See **Chapter 8** for additional details.

FIGURE 9.11
Side Street Detection
Case A

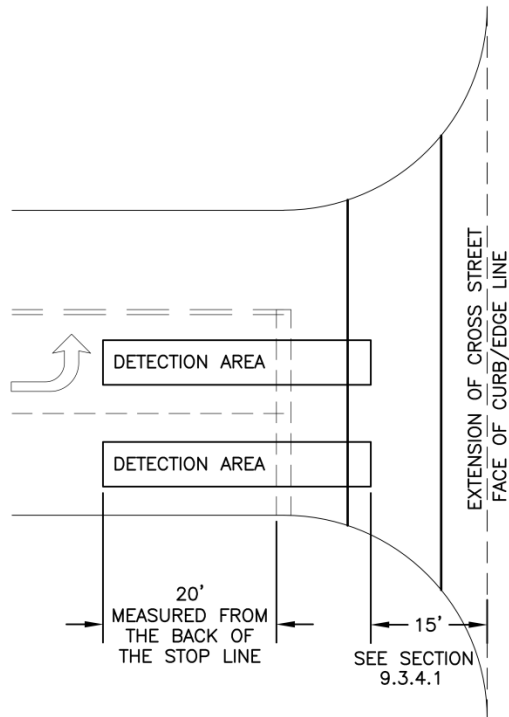

FIGURE 9.12
Side Street Detection
Case B

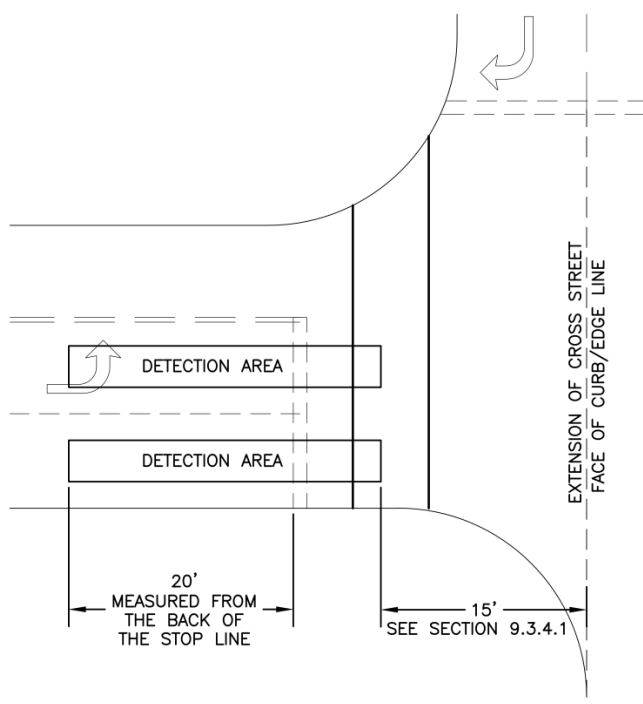
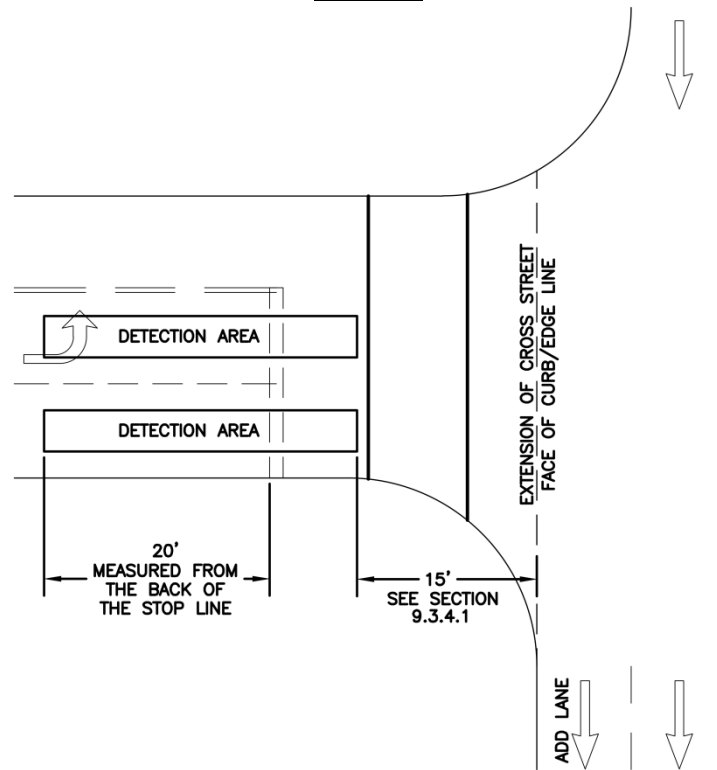

Figure 9.13
Side Street Detection
Case C



9.3.7 Left Turn Detection

9.3.7.1 Major Street Protected Only Left Turn

Left turn detection shall be positioned at the stop line per the requirements outlined for side street detection in **Section 9.3.6**.

Phase shall be set to "Memory On" or "Lock".

9.3.7.2 Major Street Protected / Permissive Left-Turn

With protected / permissive left turn phasing and the major street through phase set to recall, second car detection should be used to activate the associated left turn phase as illustrated in **Figure 9.15**.

Detection shall be set to "Memory Off" or "Non-Lock".

For second car detection, the front of the detection area shall be 25 ft. from the back of the stop line and 25 ft. in length.

9.3.7.3 Major Street with no left turn phase

If a dedicated left turn lane is provided without a protected only or protected/permmissive left turn phase, 2nd car detection shall be provided and connected to the adjacent through phase. Second car detection is illustrated in **Figure 9.15**.

9.3.7.4 Side Street Protected Only Left Turn

Left turn detection shall be positioned at the stop line per the requirements outlined in **Section 9.3.6**.

Detection shall be set to “Memory On” or “Lock”.

9.3.7.5 Side Street Protected / Permissive Left-Turn

Two detection areas shall be used to call the associated phases as illustrated in **Figure 9.14**. One detection area shall be placed at the stop line consistent with the requirements of **Section 9.3.6** to call the side street through phase. A second detection area shall be positioned 25 ft. from the back of the stop line to call the protected left turn phase. This second detection area shall be 25 ft. in length.

Figure 9.14
Side Street Left Turn Detection For Protected / Permissive Left-Turn

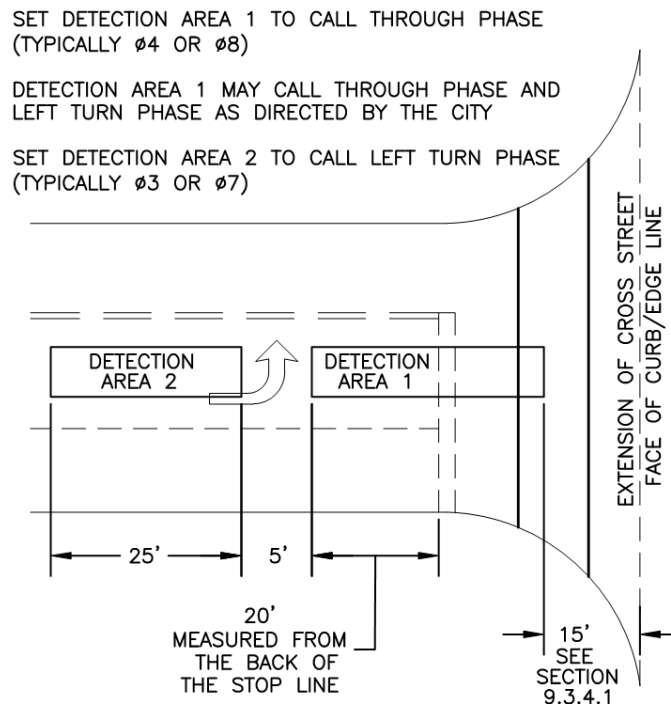
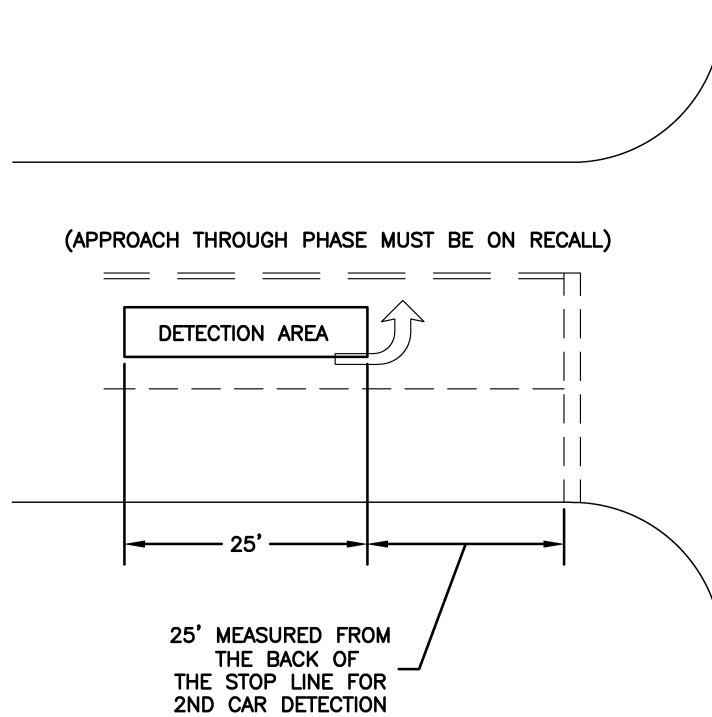

Figure 9.15
Major Street Left Turn Detection For Protected / Permissive Left-Turn



9.3.8 Advanced Detection

Advanced detection shall be used to call/extend the major street through phase, except as noted below.

For roadways with a posted speed limit of 35 miles per hour or less, advanced detection shall be placed at 110 ft. from the back of the stop line.

Advanced detection is only used in actuated signal systems. Where the signal system operates on fixed time, (i.e. downtown), advanced detection shall not be used. **Table 9.4** provides detector locations and **Figure 9.16** details the application of advanced detection placement.

9.3.9 Dilemma Zone Detection

Dilemma zone detection should be used to provide drivers adequate time to make a decision whether to stop or continue through the intersection when the yellow indication is displayed.

Dilemma zone protection is only used in actuated signal systems. Where the signal system operates on fixed time (i.e. downtown), dilemma zone

protection should not be used.

Dilemma zone protection is generally used when the posted speed is 40 miles per hour or greater (major and/or minor streets) and should accommodate vehicle speeds ranging from 35 miles per hour to the posted speed limit.

The manner in which dilemma zone protection is provided depends on the detection technology to be used. The City's preferred form of dilemma zone detection is via radar technology, which continuously tracks the changing distance, speed, estimated time of arrival (ETA), and qualified count of multiple vehicles from the point where they enter the radar unit's field of view (approximately 600 feet upstream) to the stop line.

Video detection and inductive loop technologies provide dilemma zone detection by estimating headways via presence detection zones at discreet points, and passage time. **Table 9.4** provides detector locations and **Figure 9.16** details the application of dilemma zone detection.

Table 9.4
Advanced/Dilemma Zone Detector Locations

Posted Speed Limit (mph)	Advance Detector Location ⁽¹⁾ (ft.)	Dilemma Zone Detector Location ⁽²⁾ (ft.)
35 or less	110	N.A
40	110 ⁽²⁾	293
45	110 ⁽²⁾	330
50	110 ⁽²⁾	367
55	110 ⁽²⁾	403

Notes:

(1) Major Street only

(2) Video and Loop Detection only

Figure 9.16
Advanced/Dilemma Zone Detection

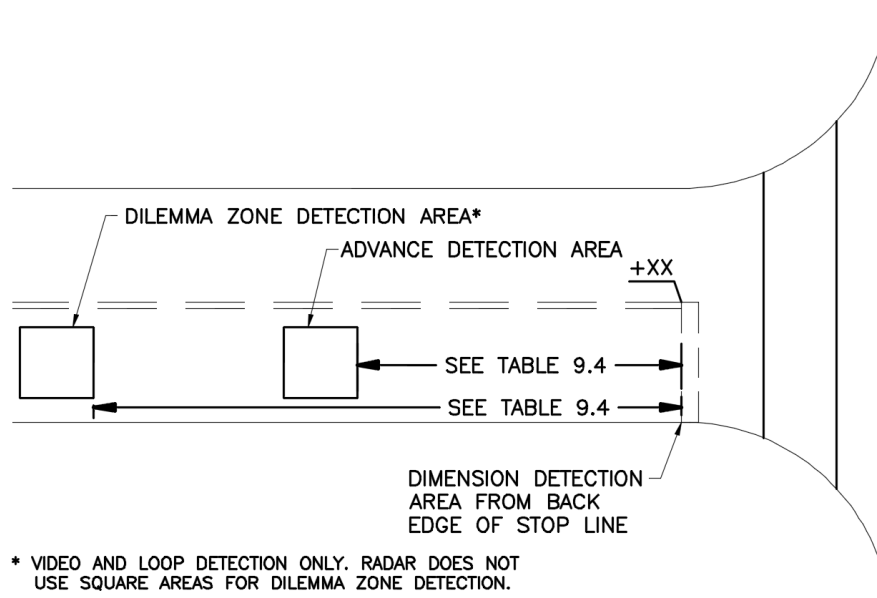

9.3.10 System Detection

Intersection detection areas should be identified with a system detection identifier when they are also used as system detectors in a closed loop coordinated signal system. Identifiers shall be assigned based on the following guidelines. Examples are also illustrated in the **Section 9.4** plan details.

- “EXP #” shall be assigned to advanced detection areas.
- A(1) through D(2) shall be assigned to presence detection areas.
- Assign values south to north and west to east, starting with the major street.
- The City will furnish guidance on which intersection detectors will also be designated as system detection areas.

9.3.11 Bicycle Detection

All newly installed detection areas shall reliably detect bicycles.

Radar detection is the preferred bicycle detection method.

Bicycle Detector Markings shall be used when a bicycle needs to actuate a traffic signal phase in order to proceed through an intersection. Bicycle detection markings are not used for right turn only lanes when right turn on red is permitted. Bicycle detection markings are not used for second vehicle detection.

Bicycle detector markings are used to assist a bicyclist (or motorcyclist) with identifying the most likely location to actuate a traffic signal phase. Bicycle marking locations identified shall be used to reduce the likelihood of a motor vehicle attempting to overtake a stopped cyclist. As detailed in **Section 8.14**, bicycle detection markings shall be accompanied by a R10-22 Bicycle Detector Sign.

Placement guidelines are detailed on [City of Columbus Standard Construction Drawing 4301](#).

Bicycle Only Loop Detector

- When permitted by **Section 9.2** a dedicated bicycle only loop detector may be used only at the direction of the City of Columbus, City Engineer or appointed designee for bike lane, cycle track or bike box applications. Bicycle only loop detection is detailed on [City of Columbus Standard Construction Drawing 4300](#). Bicycle detector markings shall be as detailed in the [Ohio Manual of Uniform Traffic Control Devices](#).

9.4 Detection Plan Components

Each detection area shall be clearly shown on the plan and labeled with an identification number. Station information shall be provided detailing the location of each detection area. Dilemma zone detection areas shall not be shown on the plan when using radar detection.

9.4.1 Detection Identification Numbers

Detection area identification numbers shall be assigned based on the associated signal phase. A detection area assigned to phase 6 should be numbered Z6. If more than one detection area is assigned to phase 6, detection areas shall be numbered Z6a, Z6b, Z6c, Z6d, etc. Letter assignment shall be applied from the inside lane to the outside lane and then from the stop line extending away from the intersection. Use “Z” for zones and “L” for loops. Examples are provided on the sample plan sheets published by the City of Columbus, Department of Public Service, [Sample Plan Sheets](#).

9.4.2 Detection Chart

A vehicle detection chart shall be provided specifying: detection area identification number, size, phase, delay, type, and unit/channel (standard 2 channels) information. Detector chart examples are provided in **Tables 9.5** through **9.9**.

- These charts are only examples. Each detector chart must be customized to reflect the need of the project.
- The SYSTEM DETECTOR column shown in **Table 9.9** shall only be used if the signal is part of a closed loop system. Not all detection areas will be assigned a value. See **Section 9.3.10**.
- Abbreviation definitions:
 - N – near; M – middle; F – far; L- left; R - right
 - EBLT (F) and WBLT (F) - 2nd-vehicle detection areas when a first vehicle detection area EBLT and WBLT are assigned to the through phase.

Table 9.5
Detection Chart – Example #1
(Radar Detection – 45 MPH)

Detection Zone (#)	Radar Detector (#)	Phase	Detection Zone Size (W' x L')	Presence	Purpose	Delay Data	
						Delay (Sec.)	Inhibit Delay During Green (Phase)
---	1	Ø 6	2 lanes x 600'	X	Dilemma Zone	---	---
Z1	2	Ø 1	5' x 25'	X	Call/Extend	3	Ø 1
Z5	3	Ø 5	5' x 25'	X	Call/Extend	3	Ø 5
---	4	Ø 2	2 lanes x 600'	X	Dilemma Zone	---	---
Z4a	5	Ø 4	5' x 40'	X	Call/Extend	3	Ø 4
Z4b	5	Ø 4	5' x 40'	X	Call/Extend	5	Ø 4
Z8a	6	Ø 8	5' x 40'	X	Call/Extend	3	Ø 8
Z8b	6	Ø 8	5' x 40'	X	Call/Extend	5	Ø 8
Dilemma Zone Speed Threshold: >35 MPH							

Table 9.6
Detection Chart – Example #2
(Video Detection)

Detector (#)	Camera (#)	Phase	Detection Zone Size (W' x L')	Presence	Delay Data	
					Delay (Sec.)	Inhibit Delay During Green (Phase)
Z6	1	Ø 6	6' x 6'	X	---	---
Z1	1	Ø 1	5' x 25'	X	3	Ø 1
Z5	2	Ø 5	5' x 25'	X	3	Ø 5
Z2	2	Ø 2	6' x 6'	X	---	---
Z4a	3	Ø 4	5' x 40'	X	3	Ø 4
Z4b	3	Ø 4	5' x 40'	X	5	Ø 4
Z8a	4	Ø 8	5' x 40'	X	3	Ø 8
Z8b	4	Ø 8	5' x 40'	X	5	Ø 8

Table 9.7
Detection Chart – Example #3
(Inductive Loop Detectors)

Detector (#)	Detector Assignment		Phase	Loop Size (W' x L')	Loop Delay Data		Detector Unit Rack & Cable Label
	Unit (#)	Channel (#)			Delay (Sec.)	Inhibit Delay During Green (Phase)	
L1a	1	1	Ø 1	6' x 6'	---	---	SB (R)
L1b	1	2	Ø 1	6' x 6'	---	---	SB (L)
L4	2	1	Ø 4	5' x 25'	3	Ø 4	SBLT
L1c	2	2	Ø 1	6' x 6'	---	---	NB (L)
L1d	3	1	Ø 1	6' x 6'	---	---	NB (R)
L3a	3	2	Ø 3	5' x 30'	12	Ø 3	WBRT
L3b	4	1	Ø 3	5' x 31'	3	Ø 3	WBLT

Table 9.8
Detection Chart – Example #4
(Inductive Loop Detectors and Video Detection)

Detector (#)	Detection Type	Camera (#)	Detector Assignment		Phase	Detection Area Size (W' x L')	Loop Delay Data		Presence	Detector Unit Rack & Cable Label
			Unit (#)	Channel (#)			Delay (Sec.)	Inhibit Delay During Green (Phase)		
Z6	Video	1	---	---	Ø 6	6' x 6'	---	---	X	---
Z1	Video	1	---	---	Ø 1	5' x 25'	3	Ø 1	X	---
Z5	Video	2	---	---	Ø 5	5' x 25'	3	Ø 5	X	---
Z2	Video	2	---	---	Ø 2	6' x 6'	---	---	X	---
L4a	Loop	---	1	1	Ø 4	5' x 35'	3	Ø 4	X	SBLT
L4b	Loop	---	1	2	Ø 4	5' x 35'	5	Ø 4	X	SB
L8a	Loop	---	2	1	Ø 8	5' x 35'	3	Ø 8	X	NBLT
L8b	Loop	---	2	2	Ø 8	5' x 35'	5	Ø 8	X	NB

Table 9.9
Detection Chart – Example #5
(Inductive Loop Detectors in a Closed Loop System)

Detector (#)	Detector Assignment		Phase	System Detector	Loop Size (W' x L')	Loop Delay Data		Detector Unit Rack & Cable Label
	Unit (#)	Channel (#)				Delay (Sec.)	Inhibit Delay During Green (Phase)	
L2b	1	1	Ø 2	EXP 3	6' x 6'	---	---	SB (R)
L2a	1	2	Ø 2	EXP 4	6' x 6'	---	---	SB (L)
L5	2	1	Ø 5	A2	5' x 25'	3	Ø 5	SBLT
L1	2	2	Ø 1	A1	5' x 25'	3	Ø 1	NBLT
L6a	3	1	Ø 6	EXP1	6' x 6'	---	---	NB (L)
L6b	3	2	Ø 6	EXP2	6' x 6'	---	---	NB (R)
L8a	4	1	Ø 8		5' x 29'	3	Ø 8	EBLT (N)
L8b	4	2	Ø 8	C1	5' x 29'	5	Ø 8	EB
L3	5	1	Ø 3	B1	5' x 25'	3	Ø 3	EBLT (F)
L4c	5	2	Ø 4	C2	5' x 30'	5	Ø 4	WBRT
L4b	6	1	Ø 4	D1	5' x 34'	3	Ø 4	WB
L4a	6	2	Ø 4		5' x 35'	3	Ø 4	WBLT (N)
L7	7	1	Ø 7	B2	5' x 25'	3	Ø 7	WBLT (F)

CHAPTER 10: POWER SERVICE

10.1 Power Source

Traffic signal power shall be 120VAC, single phase. Power should be provided by the most accessible source and may be provided by the City of Columbus Division of Power, the American Electric Power Company (AEP), or the South Central Power company. If power can be provided by the City of Columbus Division of Power and another power company, the City of Columbus Division of Power source should be used. Contact information for each power company is listed below:

Columbus Division of Power

3500 Indianola Avenue
Columbus, Ohio 43214

Business Manager

Office: (614) 645-7216

American Electric Power Company (AEP)

850 Tech Center Drive
Gahanna, Ohio 43230

Joint Use Coordinator

Office: (614) 883-6983

Business Services Representative

Office: (614) 883-7935

South Central Power Company

10229 Busey Road
Canal Winchester, OH 43110

Business Services Representative

Office: (800) 282-5064

Documentation of approval for the available power source shall be provided by the power company and furnished to the City of Columbus before plans are signed. This documentation may be an e-mail from the power company providing conformation or identification of a power source.

The power connection point shall be as close as practical to the proposed traffic signal cabinet.

A disconnect switch shall not be used. A meter shall be specified on all new construction or retrofit applications where the controller cabinet is being replaced.

10.2 Overhead Power Service

Traffic signal service/power cable shall be routed directly between the power source and the traffic signal cabinet.

When a ground mounted traffic signal cabinet is used, overhead power service shall drop down a utility pole and be routed underground to the traffic signal cabinet. This cable shall not enter any pull box or conduit that contains any other signal cables, nor enter a traffic signal pole/pedestal.

When a pole mounted traffic signal cabinet is used, overhead power service shall drop down the same strain pole in an external conduit riser and enter the bottom of the cabinet. Power cable shall not be placed inside the strain pole. Reference is made to [City of Columbus Standard Construction Drawing 4052](#). Conduit risers used for traffic signal power cables shall not be used on mast arm structures.

Service cable for pole mounted traffic signal cabinets shall be installed a minimum of 1 ft. above the traffic signal cable/messenger wire. It shall not be combined with other aerial traffic signal or interconnect cables. Service cable shall not attach to strain poles or mast arms when the traffic signal cabinet is ground mounted.

Power cable between the transformer and the meter shall be 3-conductor and the power cable between the power meter and the controller cabinet shall be 2-conductor as specified in the [City of Columbus Construction and Material Specifications](#), Table 732.19-1. A minimum of 6 AWG cable shall be specified.

10.3 Underground Power Service

Traffic signal power cable shall be routed directly between the power source and the traffic signal cabinet. This cable shall not enter any pull box or conduit that contains any other signal/interconnect cables nor enter a traffic signal pole/pedestal.

See **Section 13.4.2** for conduit requirements.
See **Section 13.7.5** for pull box requirements.

Power cable between the transformer and the meter shall be 3-conductor and the power cable between the power meter and the controller cabinet shall be 2-conductor as specified in the [City of Columbus Construction and Material Specifications](#), Table 732.19-1. A minimum of 8 AWG cable shall be specified.

10.4 Power Meter Cabinet Placement

The following factors shall be considered when determining a location for a proposed power meter cabinet. Evaluation of these design elements should also be reviewed during the post-stage 1 field meeting, if scheduled. City of Columbus approval of proposed cabinet location is recommended prior to plan development.

1. When the power meter cabinet services one traffic signal, the meter cabinet should be located within 5 ft. of the controller cabinet. When the power meter cabinet services two traffic signals, the cabinet should be located near the transformer providing service.
2. Wherever possible, the cabinet should not be located in the sidewalk. When the right-of-way is constrained and the cabinet must be installed in the sidewalk, a four foot pedestrian access route (PAR) adjacent to the meter cabinet shall be maintained. Reference is made to the [City of Columbus ADA Rules and Regulations](#).
3. The location should provide a safe location for maintenance staff to park and access the cabinet. Accommodations should be in the City right-of-way.
4. The cabinet should be located in an area that provides the most protection from damage by errant vehicles. Cabinets shall be located in accordance with Section 600.2, (Clear Zone) of the [Location and Design Manual, Volume 1](#), (L&Dv1) (Ohio Department of Transportation). For cabinet placement, the operational offset outlined in [L&Dv1](#), section 600.2.3 shall be increased from 1.5 ft. to 3 ft. for all power meter cabinets.
5. The cabinet shall be positioned to allow the door to fully open. The location shall allow adequate clearance from an adjacent structure to permit unobstructed access for maintenance staff and maintenance equipment. Maintenance staff shall not be required to stand too close or within the roadway.

10.5 Power Service - Plan Components

The power source location including the pole or transformer number with station/offset shall be clearly identified on the traffic signal plan.

The wiring diagram shall detail the power service connection requirements. Examples are provided in **Figure 7.5** and **7.6**.

10.6 Voltage Drop

Upon request by the City of Columbus, voltage drop from the power source to the traffic signal controller shall be calculated and submitted for review/approval. Voltage drop shall not be permitted to exceed 5 percent.

Voltage drop shall be calculated based on a fixed current draw of 20 AMP unless the current draw is expected to be unusually high. In this case, the calculated current draw shall be used.

10.6.1 Voltage Drop Equations

$$\text{Voltage Drop} = \frac{(2 \times R \times L \times i)}{1000}$$

Where:

R = Wire resistance per 1000 ft.
@ 75 degrees C. (See NEC,
(Chapter 9, Table 9). (Ω))

L = one way length (ft.)

i = current draw (amps) = 20 AMP (see above)

CHAPTER 11: CONTROLLER / CABINET

11.1 Traffic Signal Controller / Cabinet

Traffic signal controller and cabinet equipment shall be furnished in accordance with Sections 633 and 733 of the current version of the [City of Columbus Construction and Material Specifications](#).

Materials shall also be in accordance with the City of Columbus [Qualified Products List](#).

11.1.1 Traffic Signal Controllers

Controllers used for City of Columbus maintained intersections shall be NEMA (National Electrical Manufacturers Association) TS-2, Type 2 and shall be fully compatible with both NEMA TS-1 and NEMA TS-2 cabinets.

11.1.2 Traffic Signal Cabinets

Cabinets shall be 8-phase (16-channel), NEMA TS-2. Intersection phasing shall be per **Section 15.2**.

Cabinets shall be base mounted unless otherwise authorized by the City of Columbus, City Engineer or appointed designee.

If a pole mounted cabinet is permitted by the City Engineer or when a pole mounted cabinet is existing, the cabinet overhang shall be checked. Any extension over the pedestrian pathway in excess of 4 in. shall be considered a violation. Under these conditions the cabinet should be relocated, base mounted or the overhang shall be mitigated with an approved strategy.

When retrofitting an existing traffic signal with a new TS-2 controller cabinet, all existing traffic signal cable shall be replaced with new cable.

11.1.2.1 Traffic Signal Cabinet Sizes

Dimensions listed below are approximate and may vary slightly between different manufacturers.

Pole-mounted "M36 Stretch" = 61" ± 3" H x 36"W x 17"D

Ground mounted "Size 6" = 56"H x 44"W x 26"D

Ground mounted "P-UPS" = 55"H x 60"W x 26"D

or

=57" H x 58"W x 29"D

11.1.2.2 Traffic Signal Cabinet Placement

The following factors shall be considered when determining a location for a proposed traffic signal cabinet. Evaluation of these design elements should also be reviewed during the post-stage 1 field meeting, if scheduled. City of Columbus approval of proposed cabinet location is recommended prior to plan development.

1. The location should provide a safe location for maintenance staff to park and access the cabinet. Accommodations should be in City right-of-way.
2. The cabinet should be located in an area that provides the most protection from damage by errant vehicles. Cabinets shall be located in accordance with Section 600.2, (Clear Zone) of the [Location and Design Manual, Volume 1, \(L&Dv1\)](#) (Ohio Department of Transportation). For cabinet placement, the operational offset outlined in [L&D v1](#), section 600.2.3 shall be increased from 1.5 ft. to 3 ft. for all traffic signal cabinets.
3. The cabinet shall be positioned to allow the door to fully open. The location shall allow adequate clearance from an adjacent structure to permit unobstructed access for maintenance staff and maintenance equipment. Maintenance staff shall not be required to stand too close or within the roadway.
4. The cabinet shall be positioned to allow maintenance personnel to view the inside of the cabinet and the intersection at the same time.
5. The location should provide convenient/direct access for traffic signal power. Additional power connectivity requirements are provided in **Chapter 10**.
6. The location should provide convenient/direct access for traffic signal interconnect.

For power meter cabinet placement, see **Chapter 10**.

11.1.3 Cabinet Foundation

Cabinet foundations shall be shown to scale on the plans and per [City of Columbus Standard Construction Drawing 4162](#).

11.2 Uninterruptible Power Supply

Uninterruptible Power Supply (UPS) equipment shall be furnished in accordance with Sections 633 and 733 of the current version of the [City of Columbus Construction and Material Specifications](#).

Uninterruptible Power Supplies shall only be specified when directed by the City of Columbus. When used, detailed specifications should be obtained from the City of Columbus.

11.2.1 UPS Cabinet Foundation

Cabinet foundations and work pads shall be per [City of Columbus Standard Construction Drawing 4162](#). The work pad shall be sized to accommodate both the main controller cabinet door as well as the UPS auxiliary door.

CHAPTER 12: INTERCONNECT

12.1 Traffic Signal Interconnect

Signal interconnect system design and components shall be furnished in accordance with [Supplemental Specification 1620](#) and Sections 632, 633, 732, and 733 of the current version of the [City of Columbus Construction and Material Specifications](#).

Materials shall also be in accordance with the City of Columbus [Traffic Qualified Products List](#).

This chapter serves to describe the design methodology and equipment specifications required to maintain and expand the various communications networks that comprise the City of Columbus Traffic Signal System (CTSS).

In an effort to optimize the traffic signal operation throughout the region, maximize vehicle throughput, and minimize delay to motorists, different systems are used to interconnect traffic signals and/or provide the ability to be remotely monitored and configured. Traffic signals operation personnel based at the Columbus Traffic Management Center (TMC) use the CTSS central control system to monitor traffic flow and signal operations and are able to adjust signal timing configurations in order to alleviate traffic congestion due to morning and evening peak traffic patterns, freeway incidents, or other events. Additionally, the CTSS is a regional system including systems operated by multiple agencies in the Central Ohio area and is capable of supporting access to remote users.

The CTSS is comprised of a central control system connected to signalized intersections using a hybrid communications network structure (fiber optic, copper, and wireless infrastructure), a closed loop system, various time based coordinated (TBC) corridors and independent signals.

A multi-phase regional upgrade of the CTSS is ongoing. This upgrade includes new Ethernet networks using fiber optic, wireless radio, and cellular communications infrastructure. The infrastructure and system allows the CTSS to support Intelligent Transportation Systems (ITS) functions and an “open architecture” that simplifies future system expansion and maintenance.

12.2 Interconnect Plans

Interconnect plans shall include general note sheets (standard notes, project specific notes, and interconnect “As Per Plan” notes), plan view sheets, and communication detail sheets. Examples are provided in the Sample Plans published by the City of Columbus Department of Public Service.

12.3 Advance Notification

It is critical that the appropriate City department(s) and any other stakeholder of a regional traffic signal or other facility utilizing any part of the CTSS interconnect system be provided, at minimum, 45 days advance notice prior to any project work that may affect the performance of the interconnect system.

Upon receiving notification, the affected parties may require that countermeasures be taken in order to mitigate downtime and disruption of services to motorists or customers of their respective systems. Designs for relocation of existing or installation of temporary CTSS infrastructure shall be per **Section 3.8.1**.

12.4 Fiber Optic Network Design

12.4.1 Cable

The cable network structure is constructed using 288 strand fiber optic cable backbone installed along the freeway system. Fiber access points, referred to as communications nodes, serve as connection sites between the backbone and 144 strand fiber optic cable trunks which run along major arterials and interconnect traffic signals, vehicle flow monitors, and other City facilities.

All fiber optic backbone, trunk, and drop cables shall be of loose buffer tube, gel-free, dielectric construction, using 8.2µm core diameter single mode fiber. Buffer tube and fiber jacketing shall conform to EIA598-A color coding.

Additionally, drop cables between splice enclosures and termination panels within equipment cabinets shall meet riser rated specifications, unless specifically directed by the City.

Specifications for detailed fiber optic cable material information, testing, installation, and acceptance procedures are covered by [Supplemental Specification 1620](#).

12.4.2 Slack Storage

Installation of extra cable slack is required for future maintenance and expansion of the system. For design purposes, approximately 150 ft. of cable slack should be included for every 1000 ft. of interconnect cable installed, although specific circumstances - such as a known future fiber access point or crowded existing infrastructure - may require more or less slack cable. Cable slack should be installed near an intersection and in an accessible location.

For underground installations limit slack storage length placement to less than 100 ft. per 32" pull box and 200 ft. per 48" pull box. At crowded locations spread out slack lengths between adjacent pull boxes.

For aerial installations ensure cable slack is installed away from roadway or other areas where traffic is likely to flow under. Locations should be easily accessible and reasonably free of other overhead utilities.

In addition to slack storage, additional cable length must be included for purposes of fiber splicing. At a typical splice location, 75 ft. of each cable entering the splice enclosure is to be coiled and stored so that cable ends can be removed from pull box or aerial installation and properly prepared for splicing, although actual lengths may increase depending on field or accessibility conditions.

12.4.3 Splicing

Fiber optic cables are to be installed in continuous lengths between interconnected facilities. Only fibers used by a device at a splice location should be spliced to the drop cable, leaving unused fiber optic buffer tubes to be passed through the splice enclosure uncut. All fiber splices are to be done using core aligned fusion splicers.

The designer shall incorporate mid-run splice locations only when installation of a continuous cable is not reasonably possible, such as underground to aerial transitions, locations where the cable path abruptly changes direction, or at the direction of the City.

Additionally, the designer may allow splicing of all fibers at locations where four or more cables converge (such as the intersection of two arterial routes) and along very long continuous cable runs of 20,000 ft. or more.

Full butt splices (all strands of the cable are spliced) are not permitted within 1,000 feet (cable length) of one another. This assures that signal loss will not exceed the loss requirements of all users of the cable.

The size of splice enclosure required at a site is to be determined based upon the following factors:

1) Underground installations

There are physical constraints for a splice enclosure because of the varying sizes of pull boxes. The amount of potential total splices, buffer tubes, along with the number of fiber optic cable entries is taken in to account when selecting a splice enclosure size. In addition, for existing pull boxes, field verification to determine the amount of space and condition of it shall occur. For locations that have two trunk fiber optic cables, generally the 288-splice

enclosure should be used. For locations that have three or more trunk cable entries, the 800-splice enclosure shall be used. See **Table 12.1** for underground installations restrictions.

2) Overhead installations

There are not any physical constraints for an aerial splice enclosure. The amount of potential total splices, buffer tubes, along with the number of fiber optic cable entries is taken in to account when selecting a splice enclosure size. For locations that have two trunk fiber optic cables, generally the 288-splice enclosure should be used. For locations that have three or more trunk cable entries, the 800-splice enclosure shall be used. See **Table 12.1** for aerial installation restrictions.

Table 12.1
Typical Approximate Splice Enclosure Size

Enclosure Size	Enclosure Form	# of Splices	# of Buffer Tubes	# of Cable Entry Ports	Fits in Square 30" Pull Box	Fits in Round 32" Pull Box	Fits in Round 48" Pull Box	Allowable for Aerial Installation
7"x18" *	Dome	144	24	4	x	x	x	
9"x22"	Dome	288	36	6		x	x	x
10"x28"	Dome	800	60	8		x	x	x

*This enclosure shall not be used for permanent installations.

12.4.4 Connecting to Devices

Drop cables are used to connect cable plant to devices and facilities.

Drop cables between splice enclosures and termination panels shall meet riser rating specifications, unless specifically directed by the City.

Drop cables shall be 24-strand single mode fiber optic cable unless directed by the City of Columbus. The length of drop cable must include adequate splicing slack (typically 75 ft.), vertical distances such as through poles or risers, and any other distance required to connect between the splice enclosure location and fiber termination point.

The drop cable is spliced to the pigtail of the termination panel inside the controller cabinet.

Existing termination panels in the field may have been installed with factory pre-terminated drop cables of fixed lengths ("Gator Patch"). When removed, notes shall be included in the plans that the pre-terminated drop

cable shall be cut at the splice enclosure to ensure that the longest drop cable tail length is retained.

A typical traffic signal installation will require connectivity to the blue buffer tube from each trunk cable entering the intersection. For purposes of design simplicity and for future maintenance and inventory, only 24 fiber ruggedized termination panels are to be used, with the exception of communications nodes. At signal locations that require more than 24 fiber terminations, additional 24 fiber termination panels are to be used in order to accommodate the required amount of fibers. See **Figure 12.4 - Figure 12.10** for graphical representation of standard cable/panel orientation.

A communications node cabinet installation typically includes access to the blue tube of either 288 strand cables backbone in addition to all fibers of each incoming 144 stand cable trunk. At communications node locations with more than two incoming 288 strand cable backbones, all 288 fibers of each cable are to be terminated into the node cabinet to allow patching of all fibers.

The LC-APC termination is the standard type fiber optic connector to be used at intersections and communications node cabinets. Standard patch cables between patch panels in traffic signal cabinets are to be constructed of duplex single mode optical cable with LC-APC connectors and at 6, 12, 18, or 24 ft. incremental lengths depending on the separation of terminations they are respectively connecting. Patch cables in node cabinets shall also be armored. Non-standard patch cables may be encountered to connect to certain types of communications equipment, or while connecting to existing closed loop system equipment. In order to prevent damage to patch cables and maintain a well-organized environment, patch cable slack is to be neatly coiled and secured within the patch panel. Excessively long patch cables are not to be used due to the increased chances for tangling and unnecessary bends in the cable. Patch cable ends are to be clearly and permanently labeled with information indicating the link ID and/or termination point. See **Figure 12.1** for fiber optic patch cable color coding.

Figure 12.1
Fiber Patch Cable Jacket/Connector Color

Fiber Type	Jacket Color	CTSS Application
Single Mode	Yellow	CTSS IP Network

Connector Type	Boot Color	CTSS Application
Angled Physical Contact	Green	CTSS IP or DoT IP Network

12.4.5 Redundancy

Communications nodes built along the backbone fiber optic network shall include Layer 3 capable network switches. If a communications node drops off of the network due to power loss, equipment failure, or a cable break, the network will reroute data traffic to its destination utilizing alternate nodes and fiber pathways.

Fiber optic subnets are designed to provide a redundant communication path to a Layer 3 network switch from each intersection. Each subnet is connected to two separate Layer 3 switches at either end of the subnet as illustrated in **Figure 12.2**.

In the event a section of cable is cut between intersections or an intersection controller cabinet is knocked down, communication to the other intersections on the subnet is not interrupted since an alternate path to one of the two Layer 3 switches is maintained as shown in **Figure 12.3**.

Communications plans are to include network overview diagrams clearly representing the logical communications paths and channels between field devices.

Figure 12.2
Fiber Optic Redundancy Communications Paths

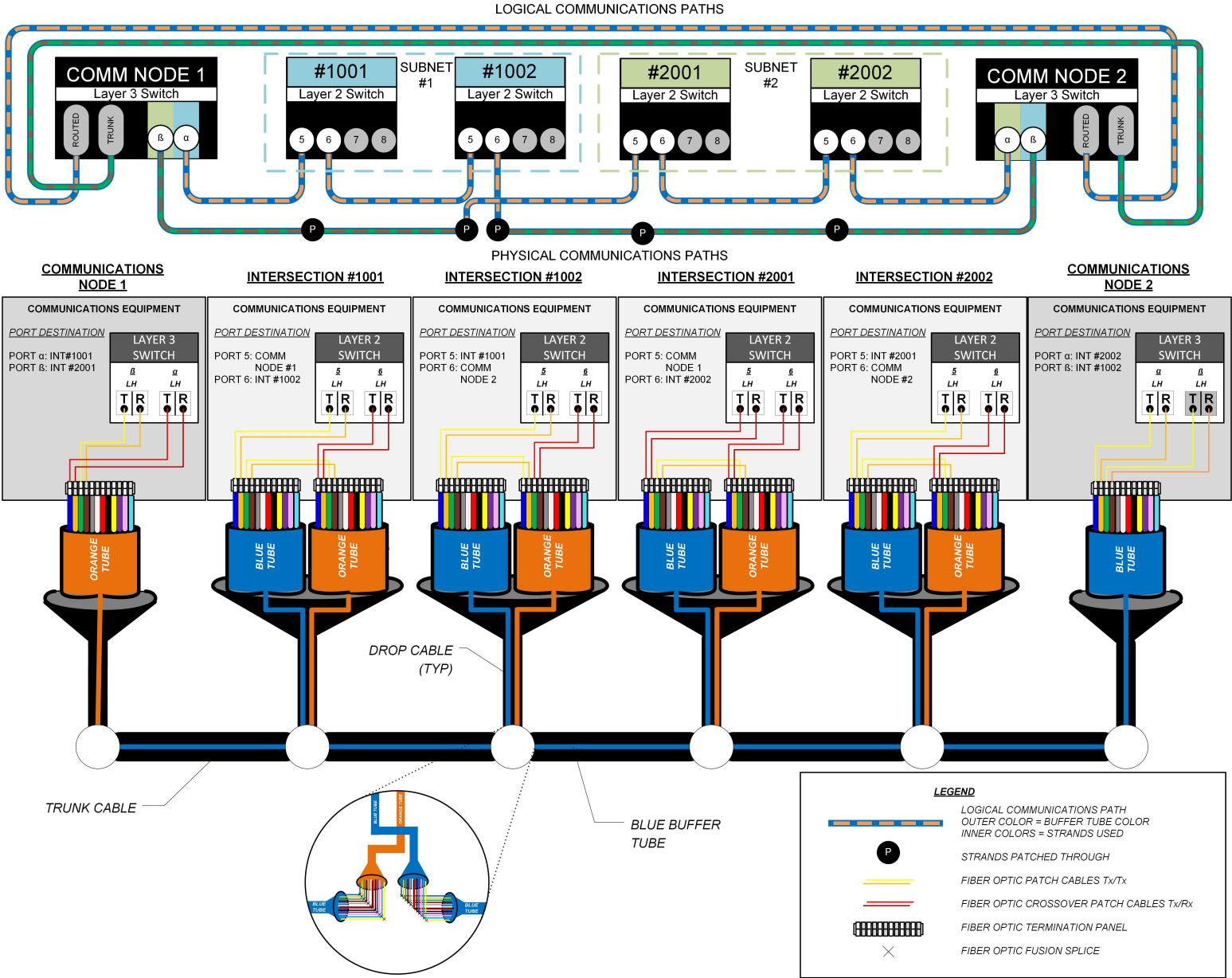
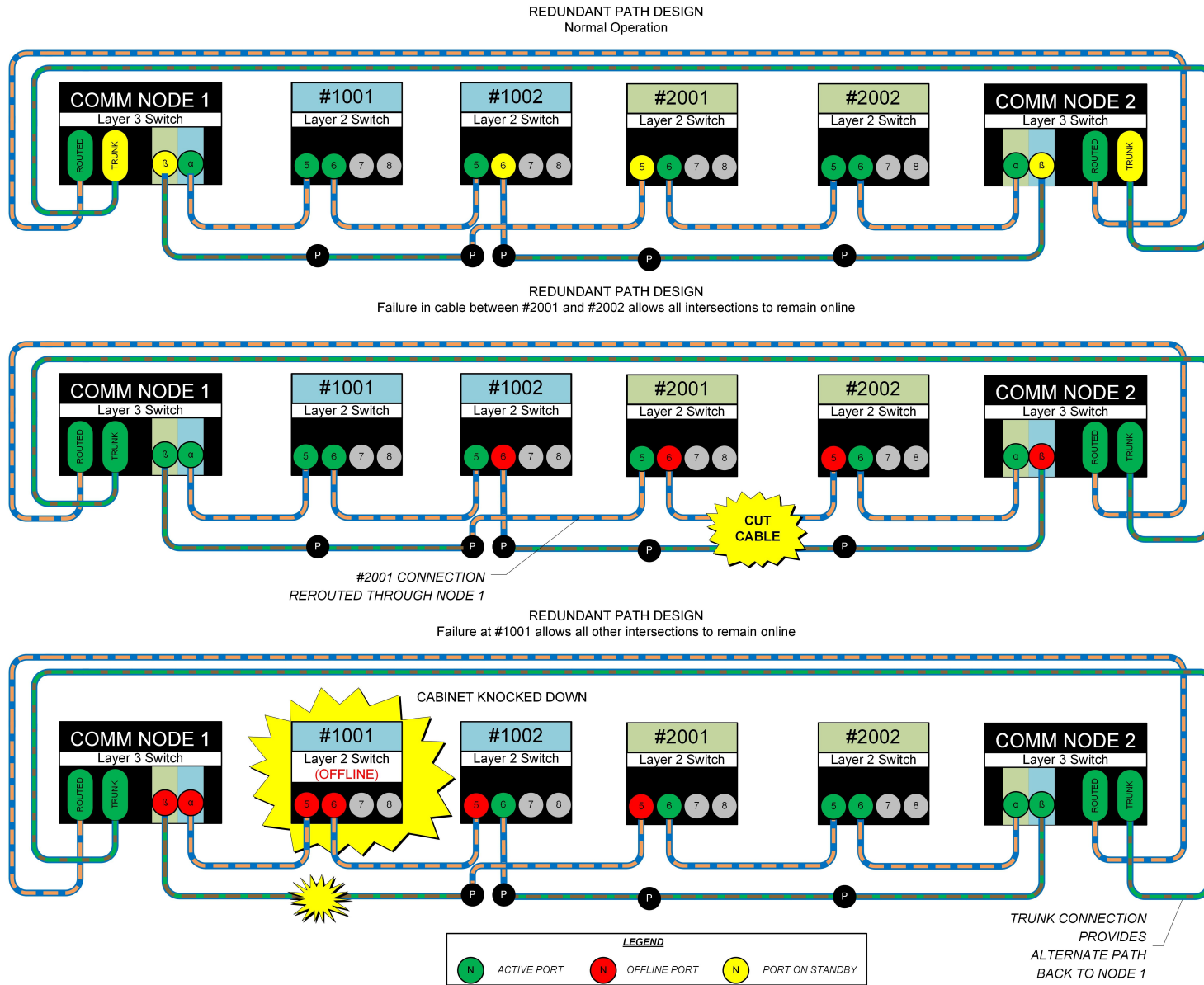

Figure 12.3
Fiber Optic Redundancy Scenarios



12.5 Communications Nodes

Communications node sites, located primarily where backbone and trunk fiber optic cables intersect, serve as aggregation points for layer two trunk network data. At the communications node, the field device data along the trunk network is transported to the backbone network using layer three network switches capable of achieving data throughput rates of 10Gbps. Network maps and information may be obtained from the City by request.

At the node location, terminate all 144 strands of fiber of each fiber optic trunk cable to a patch panel within the Node cabinet. Unless the node site consists of three or more 288 strand backbone cables, include a 24 strand drop cable connection to the backbone. Unlike at a typical signal controller cabinet, this 24 strand drop cable is to be terminated into a 19" rack mounted patch panel.

If three or more 288 strand backbone fiber cables converge at a node site, terminate all of the strands of fiber of each backbone cable in patch panels within the node cabinet. This will allow full configurability of the network as links can be patched through as necessary.

Termination panels shall fit into a standard 19" equipment rack and be capable of housing various configurations of modules that pre-terminated connector ends can be snapped in to. High density modules and duplex LC style connectors shall be used so that no more a single four rack unit tall panel is required to contain 288 fiber terminations.

Communications nodes are to include at a minimum two Type 334 signal controller cabinets mounted together on a single concrete foundation. Cabinet #1 serves primarily as the fiber optic distribution center and contains fiber optic termination panels for incoming cables. Cabinet #2 contains network switches and other electronic devices.

Regardless of the number of backbone and/or trunk cables entering the node site, the communications cabinets are to be interconnected using outdoor rated fiber optic drop cables with factory pre-terminated ends. Patch cables will not be permitted through conduit, pull boxes, or any other means between outdoor communications equipment cabinets. Indoor rated patch cables shall not be used in node cabinets.

Depending on the type of power service available at a node site, the design may include a Power Distribution Cabinet (PDC) to be installed on the communications node foundation alongside or between the 334 cabinets. The PDC is a smaller M36 controller cabinet enclosure that contains electrical step down transformers, circuit breakers, and/or disconnect switches.

Communications node sites are typically the point of convergence for multiple fiber optic cables. For this reason, a 48" pull box shall be installed adjacent to the fiber termination cabinet to provide adequate room for coiled cable slack and splice enclosures.

Refer to [City of Columbus Standard Construction Drawing 4023](#) for 48" additional pull box detail.

Figure 12.4
Typical Splicing Diagram – 2 cables

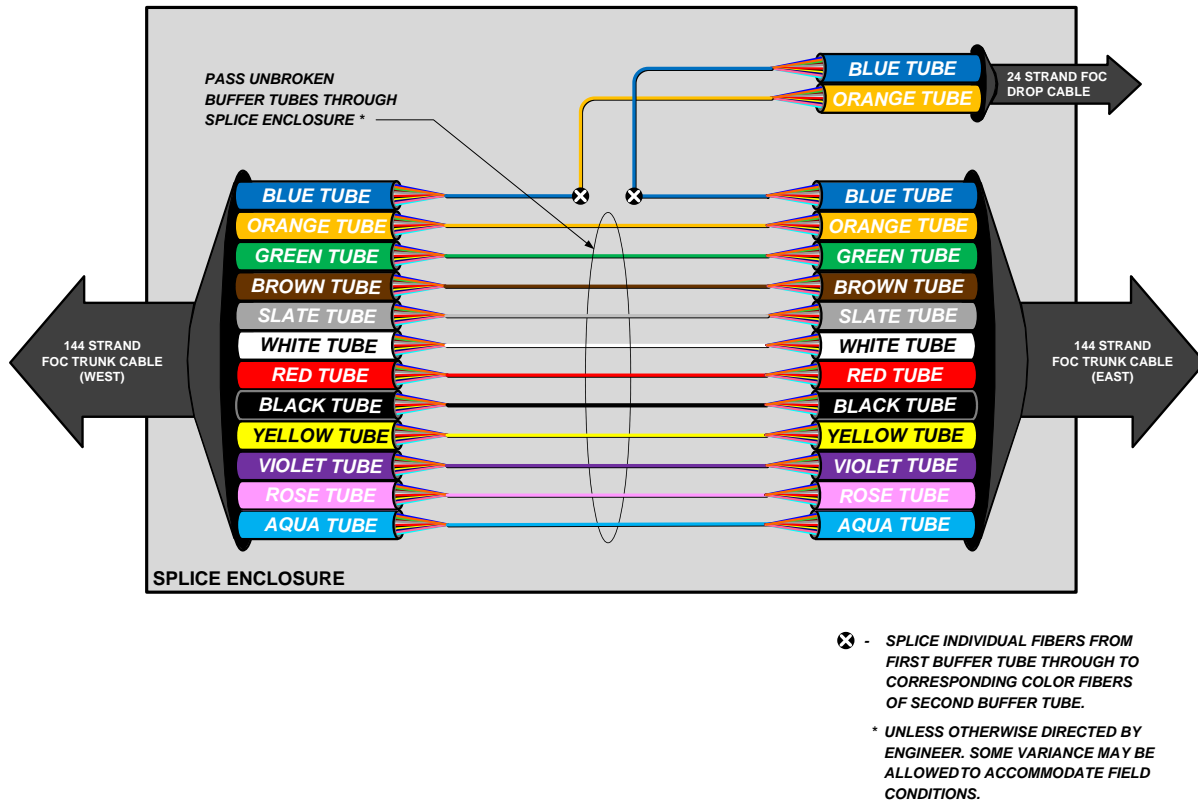

Figure 12.5
Typical Splicing Diagram – 3 cables

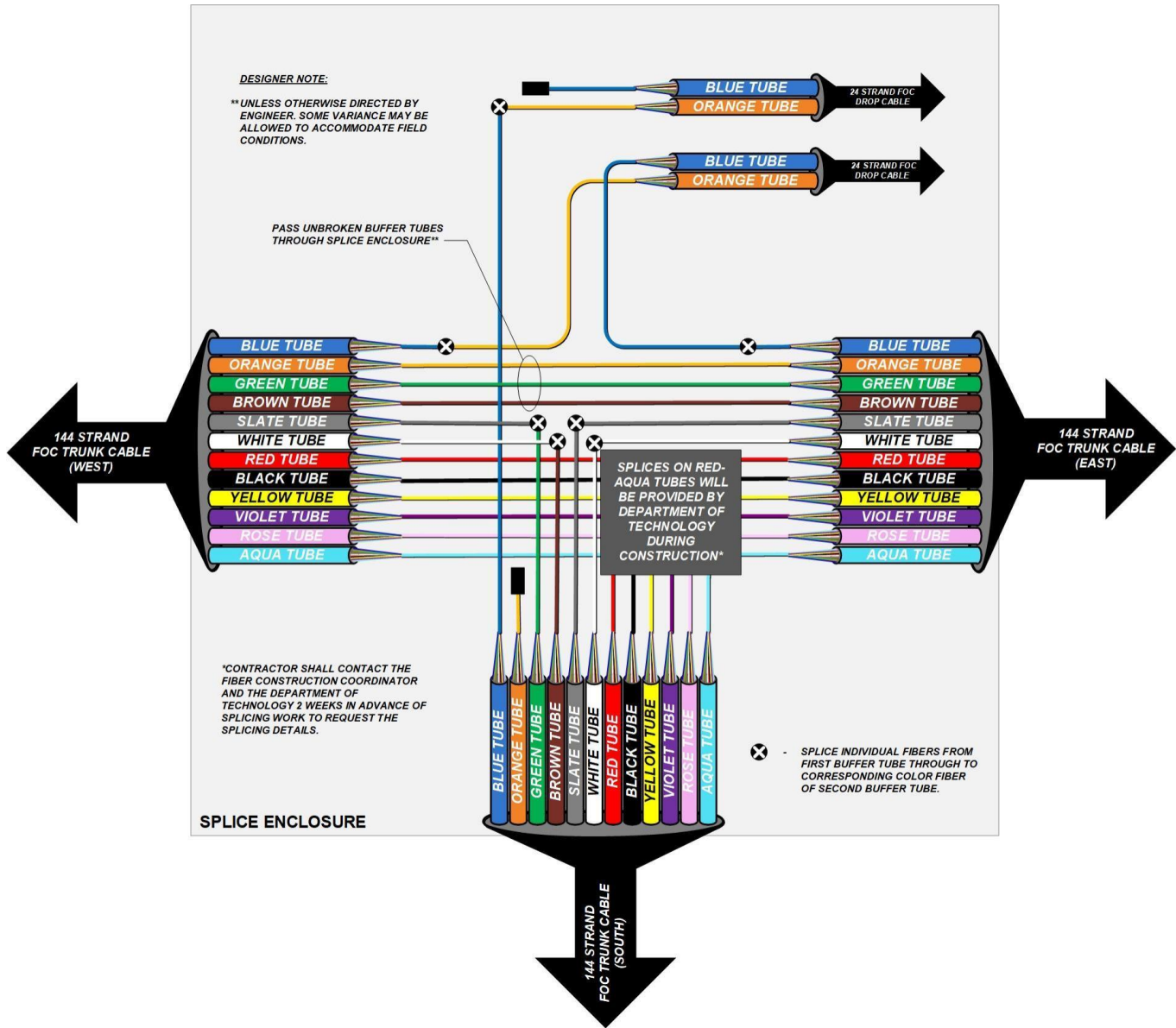

Figure 12.6
Typical Splicing Diagram – 4 cables

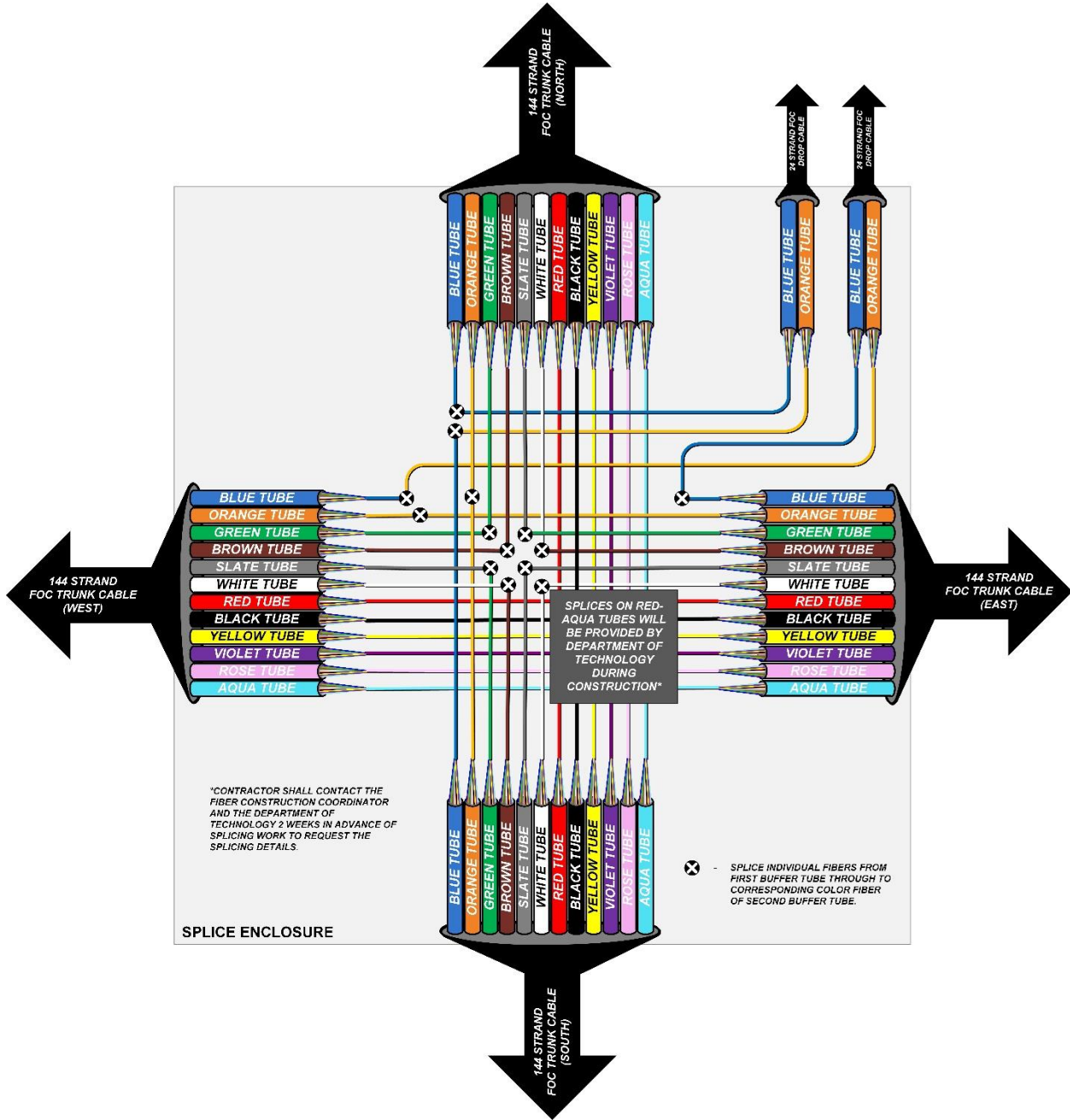

Figure 12.7
Splicing Orientation – 2 cables - East/West

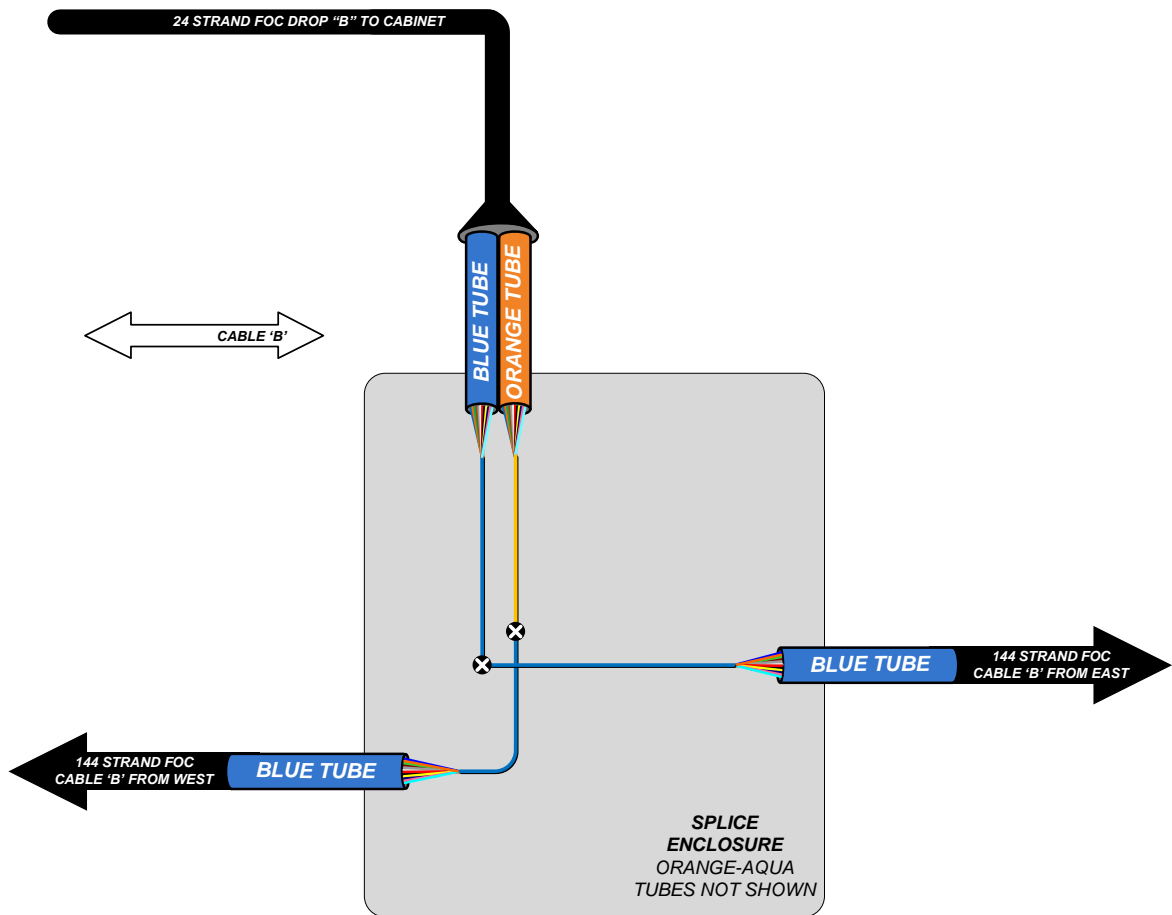

Figure 12.8
Splicing Orientation – 2 cables – North/South

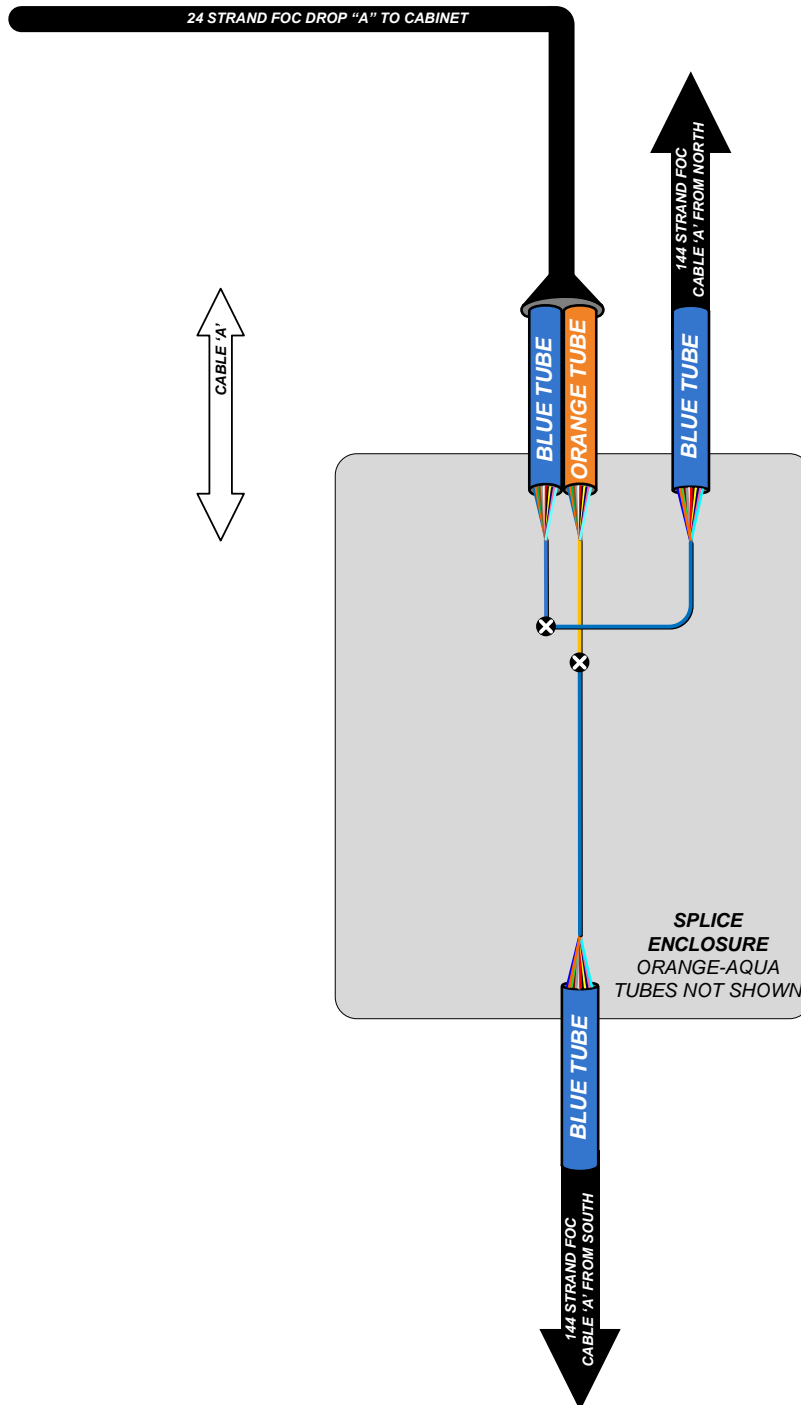

Figure 12.9
Splicing Orientation – 3 Cables

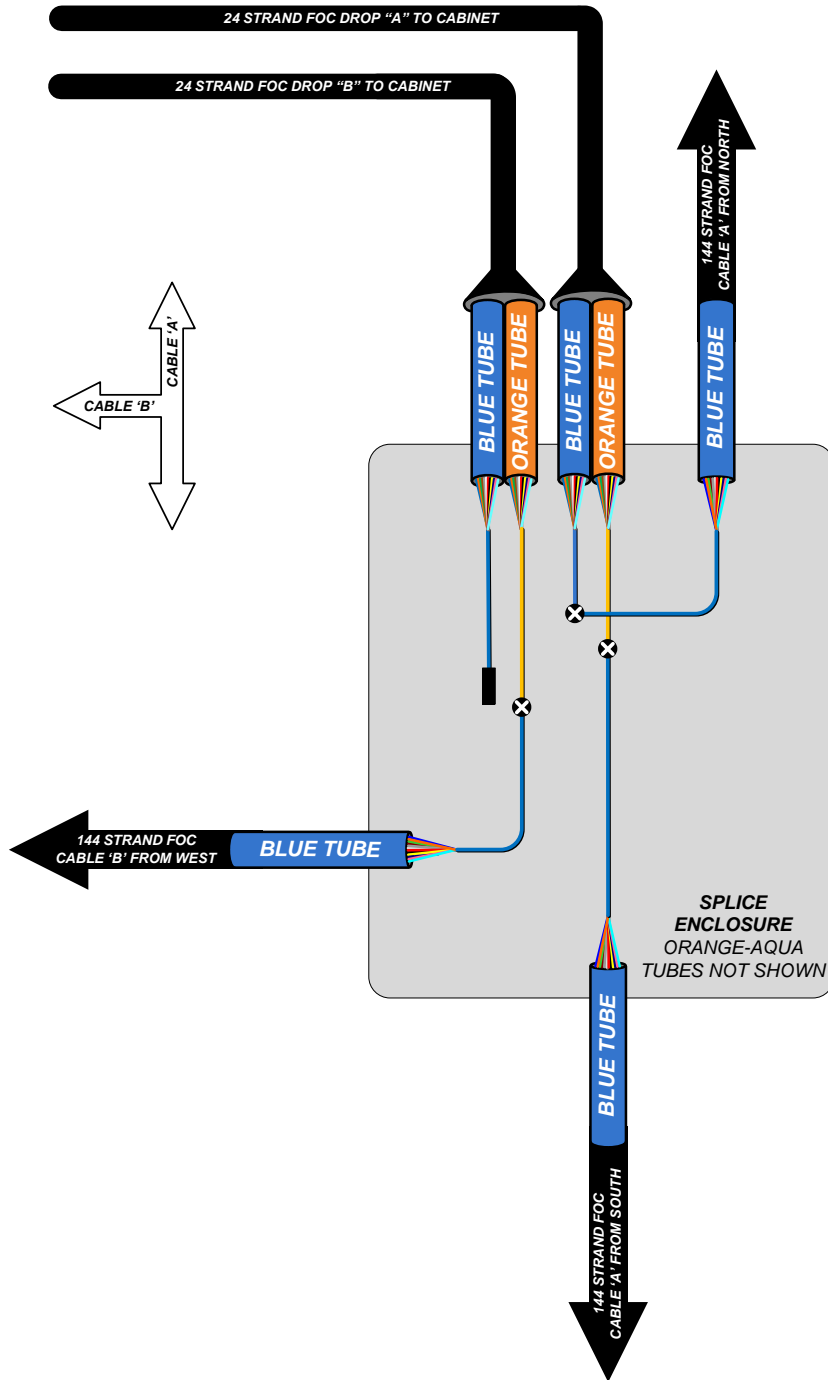
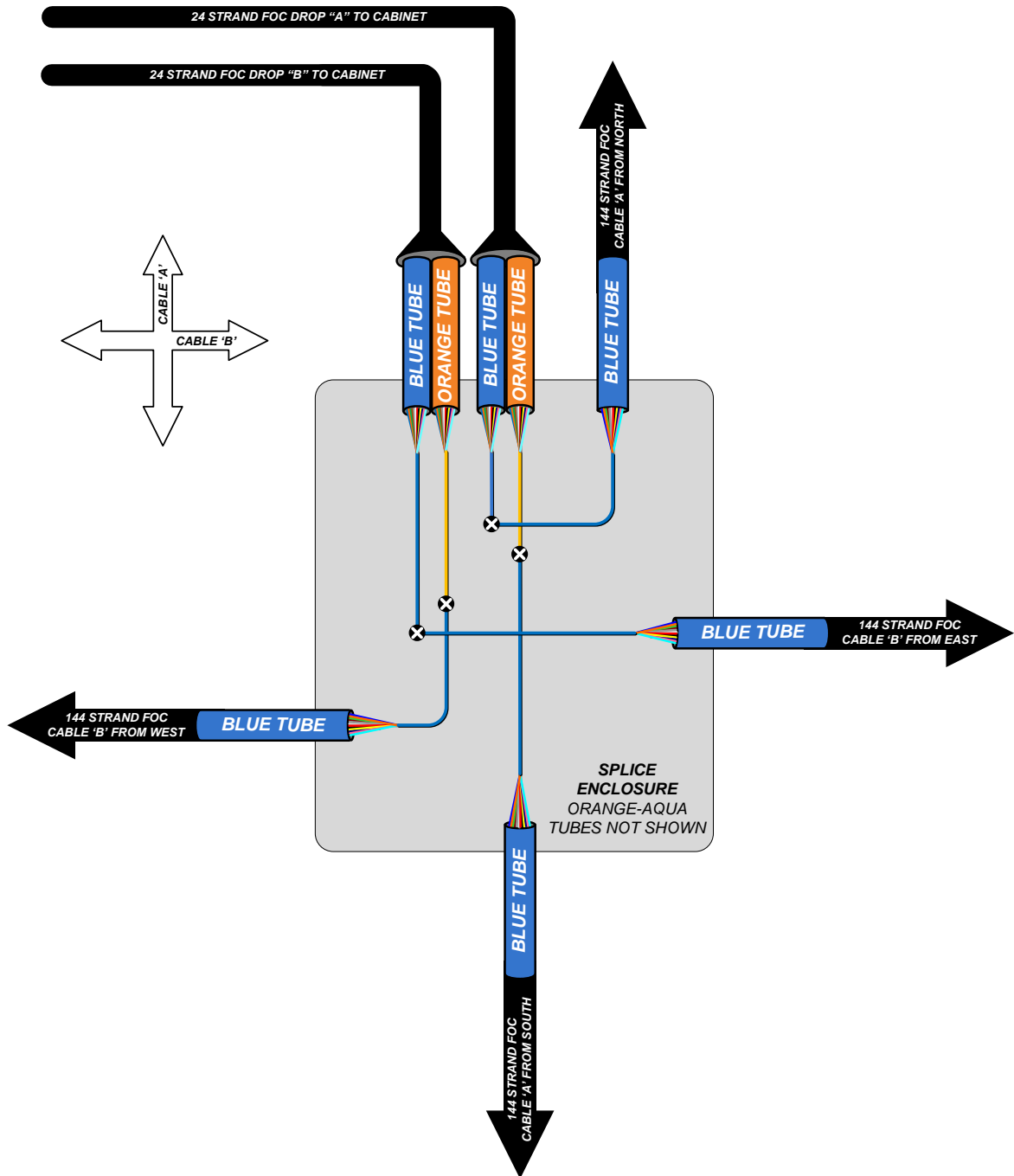

Figure 12.10
Splicing Orientation – 4 Cables



12.6 Wireless Ethernet System Design

Wireless communication equipment is sometimes installed to extend the network where the installation of fiber optic cable is not practical or cost efficient. Wireless links should be used only at the outermost remote ends of the fiber optic network, and should not be used to bridge fiber optic segments together unless they serving only as a redundant backup link.

Wireless radio equipment shall consist of spread spectrum radios and utilize 4.9 GHz licensed government safety band frequencies as shown below in **Figure 12.11** . Radios units are to be integrally constructed so that the radio and antenna are contained within the same enclosure, which is to be mounted on a strain pole, mast arm, or bracket arm. Additional bracket assemblies may be used to change the position of the radio in order to clear obstructions such as trees, signal arms, signage, or other radios.

Wireless radios are to be connected to the network equipment at the traffic signal cabinet using outdoor rated Category 5e cable. Power-over-Ethernet switches or power injector adapters are to be used to power the radio units. Coaxial cable or separate power cabling is not permitted.

Prior to the construction, a proposed wireless link should be tested by installing temporary radio equipment simulating the permanent link. This testing shall include signal strength, bandwidth throughput, and potential interference from other devices. If the temporary installation cannot be physically installed to existing infrastructure or if the proposed wireless design requires new infrastructure, bucket trucks may be used to support the radios for short term testing.

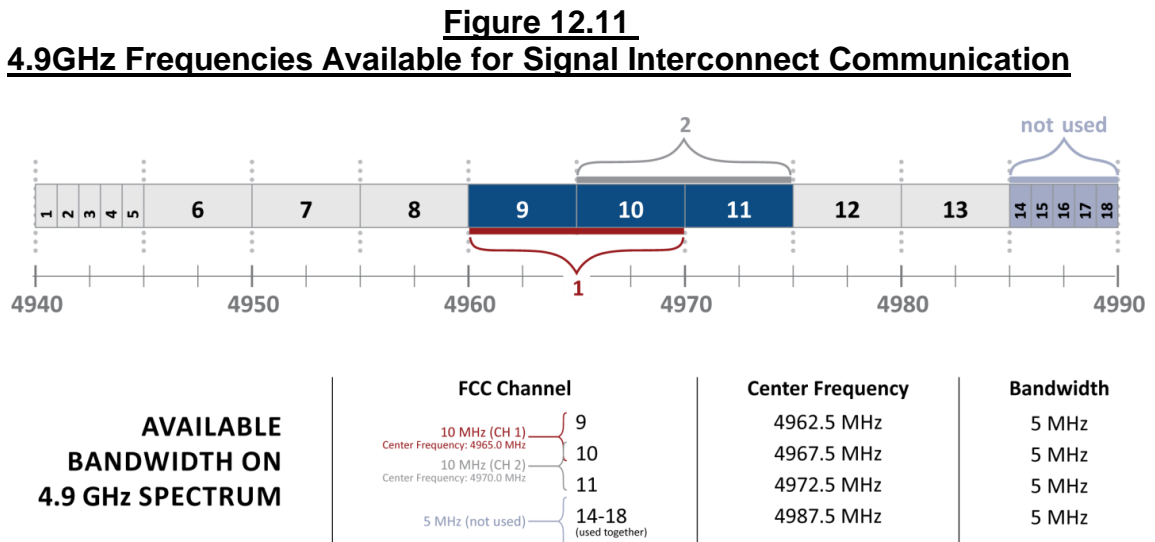

12.7 Underground Cable Installation

Underground cables shall be identified using permanent 4” tags which indicate the cable owner and contact information.

Design of proposed interconnect through existing conduit facilities requires prior coordination between facility owner and any other utility/entity that is using the existing infrastructure. Existing facilities should first be identified using record plans during preliminary design stages of the project. Once confirmation has been obtained from the City to use existing facilities, field proofing should be performed in the design phase in order to ensure that facilities are in acceptable condition and of adequate capacity to contain proposed interconnect, unless otherwise instructed by the City.

Interconnect cable (permanent or temporary) shall not be installed with private utilities or in joint use duct banks intended for private utilities.

For information regarding proposed underground interconnect duct bank systems, refer to **Chapter 13**.

12.8 Overhead Cable Installation

Overhead cables shall be identified using permanent 8” tags which indicate the cable owner and contact information.

12.8.1 New Attachments

The attachment to existing overhead utility poles requires coordination with the pole owner and other utility agencies also attached to the pole line. Engineering work may be required to determine how much “make ready” work is required before the proposed interconnect attachment can be made. Due to the significant amount of time required to complete this process, the designer must notify the appropriate utilities during the preliminary design stages of a project. Depending on the size and complexity of the project or at the request of the City, regularly occurring progress meetings including the designer, City officials, and utility company representatives may need to be scheduled to ensure the appropriate steps are completed on time.

All proposed interconnect cable is to be installed using new messenger wire as described in the CMSC. Interconnect cables shall not be lashed-in with signal cable on signal spans.

Utility pole information including owner and identification markings shall be included on the plans.

For contact information regarding power services, refer to **Sections 10.1 and 17.5.**

12.8.2 Existing Attachments

When attaching to an existing overhead interconnect path, the designer must determine whether to over lash or to remove and replace the overhead existing cable. This is dictated by the weight and condition of the existing cable and support system (i.e. messenger and lashing wire).

In some instances, where deemed acceptable by existing conditions and with approval of the utility pole owner, the design may include “over” lashing the proposed cable over the existing cable and messenger wire. For this type of installation, all pole mounting hardware and lashing wire required to over lash the proposed interconnect per plan shall be considered incidental to the cost of the interconnect.

12.8.3 Remove and Replace Existing Overhead Interconnect

In the event that the existing interconnect may not be used to over lash and support the proposed cable, it may be removed and the pole attachment points reused for the new cable.

Unless specifically instructed by the City, the existing interconnect system is to remain online through construction and until the proposed system is brought online and accepted by the City. This can be accomplished by the temporary use of J-Hooks and roller hangers to support the existing cable until the new system is online. At that time the existing cable and temporary support systems are to be removed.

The designer shall make provisions in the plans to maintain, relocate, and/or replace system loop detection where present.

12.9 Relocation and Reuse of Existing CTSS Fiber Optic Interconnect Cable

For purposes of this section, CTSS fiber optic interconnect cable refers to physical optical communications cable, drop cables, splice enclosures, and any infrastructure in place for the purpose of installing CTSS interconnect cable including, but not limited to, conduit, duct banks, aerial spans and pole attachments.

When a project or private development will impact existing CTSS fiber optic interconnect cable, the designer shall be responsible for coordination with the City to determine whether the existing interconnect cable can be relocated or requires replacement. Design plans and communications diagrams (if needed) shall be developed detailing the work to take place. Physical work associated with the installation or relocation of CTSS fiber optic interconnect cable due to a

public or private development project shall be performed by the project's contractor and shall be paid for by the project or the private developer. The contractor or subcontractor performing the work shall be an existing pre-registered and approved fiber optic contractor. Unlike other private communication utilities, the City of Columbus is not responsible for the relocation of CTSS fiber optic interconnect cable using City forces to accommodate a project or development.

When relocating CTSS fiber optic interconnect cable, the cable shall remain on the same side of the street as the existing interconnect cable unless specifically directed by the City of Columbus, City Engineer, or appointed designee. Relocation of CTSS fiber optic interconnect cable to the opposite side of the street of the existing will not be considered for less than three city blocks.

When relocating from existing aerial attachment points to new aerial attachment points, joint use agreements will need to be submitted to and approved by the pole owner per the requirements of **Section 17.5**.

Relocation shall not result in full butt splices of fiber optic interconnect cable within 1,000 feet of another full butt splice per the requirements of **Section 12.4.3**.

Unless specifically directed by the City of Columbus, City Engineer, or appointed designee, the relocation of CTSS fiber optic interconnect cable to new conduit shall not be specified. New cable shall be specified in the plans when the fiber optic cable must be pulled through new conduit for lengths greater than 50 ft.

Existing cable slack is reserved for maintenance and future connection purposes and shall not be used to accommodate relocation. An equal or greater amount of cable slack shall be retained in the final condition.

CHAPTER 13: UNDERGROUND FACILITIES

13.1 Underground Facilities

Traffic signal underground facilities shall be designed in accordance with the requirements outlined in Sections 625 and 725 of the current version of the [City of Columbus Construction and Material Specifications](#), unless otherwise detailed within.

Materials shall also be in accordance with the City of Columbus [Traffic Qualified Products List](#).

13.2 Conduit General

13.2.1 Conduit Types/Size

The following conduit types are permitted for traffic signal applications in the City of Columbus:

- Rigid metal conduit (725.04)
- PVC Schedule 40 (725.051, EPC-40-PVC)
- PVC Schedule 80 (725.051, EPC-80-PVC)
- Polyethylene (725.052, EPEC-80-HDPE)
- Flexible metal conduit (Bridge application only)
- Fiberglass conduit (Bridge application only)
- Multicell (725.20, SCH 40, SCH 80)

Conduit selection for typical traffic signal applications should consist of 1.5 in., 2 in., 3 in., or 4 in. conduit. The use of other conduit sizes may only be specified for special applications and/or when directed by the City of Columbus, City Engineer or appointed designee. Additional information is provided for conduit selection in **Section 13.4**.

13.2.2 Conduit Capacity

The maximum number of cables specified for an individual conduit shall conform to the conduit fill requirements specified in the [National Electrical Code](#). The maximum allowable conduit fill when more than two cables are installed is 40 percent.

A single 90 degree bend shall be permitted without application of a percent fill reduction factor. For each additional 90 degree bend, a 10 percent reduction to the allowable 40 percent fill shall be implemented. A maximum number of bends totaling 270 degrees shall be permitted between pull boxes.

Table 13.1 lists dimensions of conduit and **Table 7.4** lists dimensions of traffic signal cable.

Table 13.1
Conduit Dimensions

Conduit Diameter (in.)	Rigid Metal Conduit		Schedule 40 PVC		Schedule 80 PVC & HDPE Conduit	
	Internal Area (in ²)	40% of Internal Area (in ²)	Internal Area (in ²)	40% of Internal Area (in ²)	Internal Area (in ²)	40% of Internal Area (in ²)
1.5	2.071	0.829	1.986	0.794	1.711	0.684
2	3.408	1.363	3.291	1.316	2.874	1.15
3	7.499	3.000	7.268	2.907	6.442	2.577
4	12.882	5.153	12.554	5.022	11.258	4.503

13.2.3 Conduit Clearance from Adjacent Utilities

Clearances listed in **Table 13.2** represent the minimum clearance from traffic signal conduits or conduit banks. Individual utility owners may require additional clearance. Actual clearance requirements should be confirmed with utility owners. Clearances are measured from the outside edge of the conduit or conduit bank to the nearest edge of the adjacent underground item. Additional utility clearance information may be found in the [Design Guidelines for Water Distribution System Capital Improvement Projects](#) and [Right-of-Way \(ROW\) Plan Routing Manual](#). For traffic signal support foundation clearance see **Section 4.3.3**.

Table 13.2
Minimum Conduit Clearance*

	Minimum Horizontal Clearance (ft.)	Minimum Vertical Clearance (ft.)
Street lighting conduit, water line, sanitary/storm sewer line, telephone/communication line, gas line, electric lines, etc.	3	1
Pull box, street lighting foundation, water valve, fire hydrant, manhole, gas valve, vaults, etc.	3	Not Permitted

*Size and depth of adjacent utilities may increase minimum clearance.

13.2.4 Conduit Alignment

Conduit layout at a signalized intersection shall be designed to minimize the number of bends between termination points including; poles, cabinets and pull boxes. Except when used for interconnect cable, conduit alignment changes shall not exceed 270 degree between access points. The bend in any conduit shall not be less than 12 times the internal diameter of the conduit. When conduit is used for interconnect cable, the conduit alignment should provide for the most direct route and the deflection shall not exceed the natural flexibility of the conduit (typically 1 ft. over 10 ft.) between termination points.

Conduit design should also consider the entry alignment into the pull box knock-out or the location of anchor bolts when entering a pole foundation. Plan view representation of the conduit alignment shall accurately depict these entry angles and illustrate the intended conduit alignment.

13.3 Conduit Installation

13.3.1 Trench

The installation depth of proposed conduit shall correlate to the depth of the pull box structure serving the conduit. **Table 13.3** lists pull box and corresponding trench depth requirements.

Traffic conduit shall not share a common trench with any other utility or agency except for the City of Columbus Department of Technology and the Ohio Department of Transportation. Clearances for

trenches with all other utilities and agencies shall comply with **Section 13.2.3**. Sharp changes in conduit elevation will not be permitted. If both ends of a conduit run enter the same size structure, then the entire length of conduit shall be placed at that depth. If the two ends of a conduit enter different depth structures the change in elevation shall be made over the entire length of the conduit run. The bottom of a conduit bank shall enter the pull box at the bottom of a knock-out.

Plan pay items and quantities for trench depend on the location of the trench and the materials through which the trench must be cut as described in the following paragraphs.

Signal and interconnect conduit trench in grass areas shall be paid for under the standard Item 625 Trench, As Per Plan. Excavation, backfill, and restoration (seeding, mulching, plantings, etc.) are covered by this item and the area of repair does not need to be shown on the plan.

Signal and interconnect conduit trench under existing sidewalk, shared use path (SUP), and curb ramps that are not specifically scoped to be replaced by the project and would otherwise remain undisturbed shall be paid for under Item 625 Trench in Paved Area, Type A, As Per Plan. Type A shall be specified due to the need to saw cut through existing asphalt or concrete. Plans must show repair area (new walk/path and ramps) on the roadway Plan and Profile and the Intersection Detail sheets. Replacement walk or path and ramps shall be paid for under their respective pay items. In locations where new pedestrian facilities are proposed (existing walk or path is being removed and replaced as

Table 13.3
Minimum Trench Depth

	Associated Trench Depth (in.)
12 in. x 18 in. 13 in. x 24 in. Pull Boxes	24
27 in. Pull Box	30
32 in. Pull Box	30-36
48 in. Pull Box	39

part of the project), conduit trench in those areas shall be paid for under standard Item 625 Trench, As Per Plan since saw-cutting will not be required as standard roadway plan pay items will cover the removal of the existing walk/path and ramps.

Signal and interconnect conduit trench through existing roadway pavement that is not proposed to undergo full-depth reconstruction as part of the project shall be paid for using a combination of Item 625 Trench, As Per Plan and Item 259 Permanent Pavement Replacement. Item 625 covers the trenching and backfill of the soil beneath the pavement, and Item 259 covers the cutting, removal, and replacement of existing pavement. The type of roadway material being cut and replaced shall also be included in the Item 259 description per the [City of Columbus Construction and Material Specifications](#) (asphalt, brick, or concrete). Plans shall show the pavement repair area on the roadway Plan and Profile sheet along with a reference to Standard Construction Drawing 1441. In locations where full-depth reconstruction of the roadway is proposed, conduit trench in those areas shall be paid for under standard Item 625 Trench, As Per Plan only since saw-cutting will not be required as standard roadway plan pay items should cover the removal of the existing pavement.

A summary of pay items and plan requirements for signal and interconnect trench is presented in **Table 13.4**.

Table 13.4
Pay Items for Signal and Interconnect Trench

Conduit Trench Location	Item 625 Trench, As Per Plan	Item 625 Trench in Paved Area, Type A, As Per Plan	Item 259 Permanent Pavement Replacement, Type — (Type I - Asphalt; Type III - Brick; Type V - Concrete)
Grass	✓		
Under Roadway			
Full-Depth Reconstruction	✓		
Existing Pavement to Remain	✓		✓*
Under Sidewalk/SUP and/or Curb Ramps			
New ped facilities proposed in project	✓		
Existing ped facilities to remain		✓**	

PLAN REQUIREMENTS:

- * Item 625 Trench plus Item 259 shall be used in lieu of Item 625 Trench in Paved Area Type B. Show repair area and add reference to Std Dwg 1441 on Plan & Profile sheet. Item 625 Trench quantities shall be shown in Traffic Signal subsummary. Item 259 quantities shall be shown in Roadway subsummaries and with other Roadway items in the General Summary.
- ** Show replacement walk/SUP and ramps on Plan & Profile and Intersection Detail sheets. Add applicable pay items for new walk and ramps.

13.3.2 Encasement

Open cut and encased conduit shall be used for all conduits installed under roadways and driveways within the downtown and underground utility districts. Open cut and encased conduit shall also be used when the project includes full depth pavement replacement across half or more of the lanes that the conduit will cross or when other underground utility work that requires open cuts will occur on the same section of roadway as the signal conduit crossing. Conduit shall have a minimum of 3 in. of concrete encasement. Conduit concrete encasement details are provided on [City of Columbus Standard Construction Drawings 4000, 4001, and 4002](#).

When open cut and encased, conduit used under roadways or driveways for traffic signal cable, interconnect cable, power cable, and loop wires shall be concrete encased Polyvinyl Chloride PVC (725.051, EPC-40-PVC).

At street or drive crossings, concrete encasement shall extend a minimum of 5 ft. beyond the curb, edge of pavement/berm or edge of drive. When practical, it is preferred to provide encasement for the entire length of an individual conduit run.

Loop lead-in and signal cable in grass areas, and not under roadways or driveways does not need to be encased. Conduit for power cable, whether in grass areas or under pavement, shall be encased per 13.4.2.

13.3.3 Drilled or Directionally Bored

Conduits that contain only signal cables may be drilled/directionally bored under roadways and driveways except as noted in **Section 13.3.2**.

Power service cable and interconnect cable shall not be installed in drilled/directionally bored conduit.

Conduit that is drilled/directionally bored shall be High Density Polyethylene (HDPE)/(725.052, EPEC-80-HDPE).

Jacked conduit shall not be used.

Drilled/directionally bored conduit placed under roadways or driveways shall have a minimum overall depth to the top of the conduit of 24 in. or a minimum depth of 12 in. under the pavement subgrade, whichever is deeper. The maximum depth to the top of the conduit should not be more than 48 in. under the pavement subgrade.

Drilled/directionally bored conduit shall not be specified where excessive numbers of utility crossings would leave excessive numbers of repairs in the pavement surface due to the potholing (does not apply when the project will resurface).

Where drilled/directionally bored conduit is specified in the plans, consideration shall be given to installation procedures. At one end of the drilled/directionally bored section, a 4 ft. x 8 ft. receiving bore pit, free from utility conflicts, shall be specified. At the opposite end of the conduit run, the consultant shall verify there is at least 20 ft. of unobstructed space beyond the end of the conduit run within the right-of-way or a temporary easement to position the drilling machine.

Figure 13.1
Minimum Conduit
Depth Under Pavement

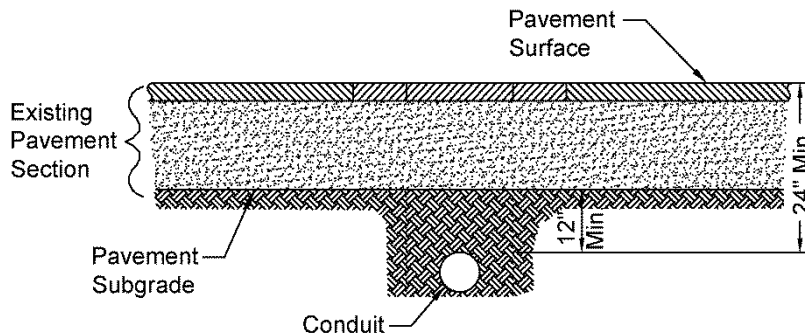

13.4. Conduit Application

13.4.1 Traffic Signal Conduit

Table 13.5 summarizes the minimum number of conduits that are to be used for various conditions.

If existing direct buried loop detector lead-in cable is located under proposed sidewalk, it shall be replaced with new cable in conduit.

13.4.2 Traffic Signal Power Conduit

Traffic signal conduit that contains a power service feed shall have a minimum of 2 in. diameter.

The Columbus standard is PVC (EPC-40-PVC), concrete encased conduit. When directed by the City, drilling/directionally boring or open trenching using a Polyvinyl Chloride (EPC-80-PVC), or Polyethylene (EPEC-80-HDPE) are acceptable alternatives.

Power service cables shall not be installed in rigid metal conduit (725.04).

Power service conduit may be in the same conduit bank as other signal and interconnect conduits but must have a 3 in. concrete encasement separation from the interconnect and signal cable conduits. Reference is made to [City of Columbus Standard Construction Drawing 4001](#). This power conduit shall not enter any pull box that contains any other signal or interconnect cables, nor enter a traffic signal pole/pedestal. As required by the [National Electrical Code](#), Section 230.7, no other traffic signal or interconnect cable shall be installed in this conduit.

Conduit containing power cable shall be routed directly between the power source and the traffic signal controller, as described in **Sections 10.2 and 10.3**.

13.4.3 Interconnect Conduit

Traffic interconnect conduit shall not be installed with private utilities and shall be installed in its own separate conduit bank. This traffic interconnect duct bank may also be used by the Department of Technology. Other public agencies such as COTA or ODOT may use the duct bank with prior approval.

Interconnect conduit shall be encapsulated with 3 in. concrete encasement. Interconnect conduit located between the controller cabinet and the adjacent pull box/signal pole does not require encasement.

Interconnect conduit shall be designed as straight as possible between pull boxes. Any change in horizontal or vertical direction between pull boxes may only be accomplished with the natural deflection of the conduit (typically 1 ft. over 10 ft.). Prefabricated conduit bends, elbows or angled deflections are not permitted unless approved by the City of Columbus, City Engineer or appointed designee.

When underground signal conduit is used, interconnect and signal conduits shall be designed in a combined conduit duct bank. Reference is made to **Table 7.6 (Types of Cable)** and [City of Columbus Standard Construction Drawing 4001](#).

Table 13.5
Minimum Number of Conduits

	Minimum No. of Conduits	Size of Conduit in.	Encasement Required
Signal cables - street crossing	2	2	+
Signal controller to primary pull box	2	3	No
	2	2	No
Power service	1	2	Yes***
Entry to traffic signal pedestal	2	2	No
Entry to traffic signal pole	2	2	No
Interconnect duct bank (in City ROW)	4	3	Yes
	1	1.5*	
Fiber optic interconnect duct (in LA-ROW**)	1	4 (multicell)	No
	1	4	
	1	1.5*	

* Tracer wire conduit

** EPC-80-PVC or EPEC-80-HDPE

*** EPC-80-PVC or EPEC-80-HDPE, non-encased conduit may only be substituted with prior approval from the City Engineer or appointed designee.

+ See Section 13.3.2

13.4.4 Bridge Conduit

Conduit may be installed under the bridge deck, through the cross frames, behind the parapet walls, or attached to vertical surfaces. Conduit shall maintain the same configuration crossing the bridge as the adjacent duct bank. When located in the cross frames, the outermost cross frame section should be used to minimize the need for additional conduit bends. Locating conduit in the bridge deck or in the parapet wall requires approval from the City of Columbus, City Engineer or appointed designee.

Conduit mounted on the truss system under a bridge deck or located on the outside of a bridge parapet shall be reinforced fiberglass. Liquid tight flexible metal conduit and fittings shall be used to connect the standard fiberglass reinforced conduit to the standard conduit. Expansion fittings shall be per the [Ohio Department of Transportation's Standard Construction Drawing HL-30.31](#)

13.5 Conduit Risers

For new anchor base pole installations, conduit risers shall not be used except for power service applications when a pole mounted cabinet is used on a strain pole; all signal and interconnect cables shall have a path through the pole structure.

13.5.1 Traffic Signal Conduit Riser Applications

Conduit risers used for traffic signal cables shall not be used on mast arm structures.

Section 13.5.1 is limited to conduit risers used for traffic signal cables. Interconnect and power applications are outlined in **Section 13.5.2** and **13.5.3**, respectively.

13.5.1.1 Existing Wood Pole

See [City of Columbus Standard Construction Drawing 4050](#).

13.5.1.2 Existing Anchor Base Pole

If conduit elbows are available in the existing foundation, signal cables shall be routed inside the signal pole.

If access through the signal pole foundation via conduit elbows does not exist, the following options shall be investigated and used in the order listed.

1. Signal cables shall be routed through a conduit riser on an existing, adjacent wood pole. Permits may be required by pole owner.
2. Install conduit into an entrance body over the top of the foundation as detailed on [City of Columbus Standard Construction Drawing 4050](#).

13.5.1.3 Existing Embedded Pole with Pole Mounted Cabinet

Conduit risers shall be used to provide access to a pole mounted cabinet. The access shall be from the top of the pole via conduit riser to the bottom of the pole mounted cabinet.

When loop detector lead-in or other signal cables are underground on the same corner as the cabinet, they shall be routed to the controller as illustrated on [City of Columbus Standard Construction Drawing 4050](#). Underground cables

must be routed through an entrance body at the base of the pole to the top, exit through a weatherhead at the top of the pole and into a conduit riser that provides access to the bottom of the traffic signal control cabinet. Access at the base of the pole shall use an entrance body as illustrated on [City of Columbus Standard Construction Drawing 4050](#).

13.5.1.4 Existing Embedded Pole with Ground Mounted Cabinet

From a loop pull box, or pedestal to an existing ground mounted cabinet on the same corner as an embedded pole: cables shall be routed through an entrance body at the base of the pole to the top, exit through a weatherhead at the top of the pole and into a conduit riser that provides access to the adjacent ground mounted cabinet.

13.5.2 Interconnect Conduit Risers

Conduit risers used for interconnect shall not be used on mast arm structures.

Conduit risers used for interconnect cable shall be of material 725.04 and as detailed on [City of Columbus Standard Construction Drawing 4602](#).

13.5.3 Power Service Conduit Risers

Conduit risers used for power service shall not be used on mast arm structures.

If an underground path to a traffic signal controller is not available, external conduit risers 725.053 (EPC-80-PVC) shall be used for power service on wood poles and strain poles (anchor base and embedded) to controller cabinets. Conduit risers shall be used as detailed on [City of Columbus Standard Construction Drawings 4051](#) and [4052](#). Conduit risers used for power service shall not be rigid metal (725.04) conduit.

13.6 Pull Boxes

13.6.1 Pull Box Locations

The conduit system layout should be developed in a manner to minimize the number of pull boxes needed for a traffic signal system. Pull boxes should be provided for the following conditions:

- When the total number of bends in a traffic signal conduit run exceeds 270 degrees. (See **Section 13.2.4** and the requirements outlined below for interconnect pull box and conduit alignment requirement).
- At the base of each traffic signal support (mast arm or strain pole) when underground cables extend from the base of the pole. A round pull box can be shared with other poles on the same corner.
- At the base of a power service drop when the conduit run exceeds 75 ft. or there is a significant change in direction.
- When a conduit run exceeds 500 ft.
- At loop detector locations.

Pull boxes lids and frames should be placed entirely within, or entirely outside, the limits of sidewalk or a paved area. Locating a pull box partially in a paved area requires advanced approval from the City of Columbus, City Engineer or appointed designee.

Pull boxes shall be located to provide for a flush transition from the surrounding area to the pull box lid.

Where pull boxes are installed, the surrounding grade shall be 4:1 or flatter.

Pull boxes shall not be located in a curb ramp, which includes: slope, flares, top landing, and bottom landing. Where plans modify an existing traffic signal pull box located in any part of an existing curb ramp, the pull box shall be removed and relocated.

Pull boxes should maintain a minimum distance of 5 ft. from back of roadway curb when conduit passes beneath the curb to enter pull box.

Typical interconnect pull box spacing should not exceed 500 ft. (520 ft. maximum) on a straight alignment. Pull boxes should be spaced evenly after considering field constraints and the following interconnect pull box placement guidelines:

- Adjacent to a traffic signal controller cabinet (this may also be used for signal cables.)
- Adjacent to an amplifier cabinet
- Adjacent to a camera cabinet
- At each end of a bridge
- At locations where aerial cable transitions to underground cable

- When a conduit run exceeds 500 ft.
- Intersections where a potential future traffic signal may occur.
- Locations where the conduit bank deflections are greater than the natural deflection of a conduit (typically 1 ft. of deflection per 10 ft. of length).

13.6.2 Pull Box Clearance

The same clearances outlined in **Section 13.2.3** and **Table 13.2** for conduit systems shall apply to pull boxes. Clearances shall be measured from the outside edge of the underground structure.

13.7 Pull Box Application

13.7.1 Loop Detector Pull Boxes (12 in. x 18 in.) and (13 in. x 24 in.)

A loop detector pull box is used for loop lead-in (homerun) cables. Other traffic signal cables should not be combined in this type of pull box.

A 12 in. x 18 in. pull box shall be used when less than 4 loops leads are served. A 13 in. x 24 in. pull box shall be used when 4 to 6 loops are served. If more than 6 loops are served, multiple 12 in. x 18 in. pull boxes shall be used.

Either pull box may be placed over an interconnect conduit bank with the loop conduit encased in the conduit bank. See [City of Columbus Standard Construction Drawing 4024](#).

Loop detector pull boxes shall not be used in traveled areas such as roads, driveways, berms, or parking lots. These pull boxes shall only be used where there is incidental travel by light to medium duty vehicles, (i.e. tractors and mowers). It is preferred that the pull box be located in grass areas, but may be in sidewalks if necessary.

13.7.2 Pull Boxes (27 in.)

A 27 in. (inside diameter) round pull box shall be used for all traffic signal cables, except power cable and interconnect cable. Loop cables may pass through these pull boxes, but they shall not contain any splice kits. These pull boxes should not be used in the roadway and are typically located adjacent to the traffic signal cabinets and mast arm supports. These pull boxes contain prefabricated knockouts for conduit entry. The capacity of the knockout should be compared to the number and size of the conduits entering the pull box. Knockouts may be enlarged, but on

rare occasions a larger pull box may be needed. See [City of Columbus Standard Construction Drawing 4021](#) for additional details.

13.7.3 Pull Boxes (32 in.)

A 32 in. (inside diameter) round pull box shall be used for traffic signal cable when it is placed in the street. A 32 in. pull box shall also be used for interconnect cable including coaxial, fiber optic, and twisted pair cables. Loop cables may pass through these pull boxes, but they shall not contain any splice kits. These pull boxes contain prefabricated knockouts for conduit entry. The capacity of the knockout should be compared to the number and size of the conduits entering the pull box. Knockouts may be enlarged, but on rare occasions a larger pull box may be needed. See [City of Columbus Standard Construction Drawing 4022](#) for additional details.

Water must be drained properly from interconnect pull boxes so water and water vapor do not enter the controller cabinet and cause damage to the electronic equipment. Interconnect pull boxes located at a low point shall contain a pull box underdrain. The underdrain shall consist of Item 603 Type E, non-perforated, 4 in., PVC conduit. If the conduit bank continuously runs downhill for 100 ft. or more, then the lowest 2 pull boxes may need an underdrain to properly discharge water from the conduit system. Pull box underdrain installation details are provided on [City of Columbus Standard Construction Drawing 4020](#).

The discharge outlet can be inserted into a roadway storm curb inlet, a storm manhole or onto the ground, but not into a sanitary or combination sanitary/storm system. Positive drainage away from the pull box and cabinet must be developed. If a ground outlet is used, then a louvered pipe end cap shall be used so animals cannot enter the pipe. A louvered end cap shall also be installed in the pull box if the underdrain pipe enters the pull box from the bottom. The underdrain flow line shall be level or slightly below the bottom of the pull box housing.

13.7.4 Pull Boxes (48 in.)

A 48 in. pull box shall be used in the following applications, where feasible:

- Where 800-splice enclosures are used.
- Adjacent to communication node cabinets.

48" pull boxes should also be considered when a splice enclosure is installed in the pull box adjacent to the signal controller cabinet.

[City of Columbus Standard Construction Drawing 4023](#) details this 48 in. pull box. Two types are illustrated:

- Type 1, provide for a standard 14 in. x 18 in. conduit knockout.
- Type 2, provides for a 14 in. wide conduit knockout that extends to the bottom of the pull box for use when placing over an existing conduit bank.
- The pull box type shall be identified in the plan callout for the 48” pull box.

Pull box placement and drainage requirement shall conform to the requirements listed in **Section 13.7.3**.

13.7.5 Traffic Signal Power Pull Box

Where pull boxes are needed in the power service conduit run, a standard non-metallic loop detector pull box (12 in. x 18 in.) shall be specified. No other cables shall be routed through this pull box.

A pull box shall be specified for power use under the following conditions:

- At the base of a power service pole and adjacent to the controller cabinet or meter cabinet if the conduit run exceeds 75 ft.
- Adjacent to a pad mounted transformer.
- When there is a significant change in direction.

13.8 Underground Facilities Plan Components

13.8.1 Conduit

Each conduit run shall be detailed with a leader and an individual callout. Conduit callouts shall individually list each conduit and indicate which cables should be installed in that conduit. Conduit callouts should also denote the method of installation, if encasement is required, and the length in feet. When multiple conduits are located in the same run, only one line should be shown on the drawings.

Interconnect Duct Bank

The interconnect duct bank shall be identified as a conduit bank. Conduit callouts shall individually list each conduit and indicate which cables

should be installed in that conduit. An interconnect cable conduit bank typical for each configuration shall be provided on the interconnect plan sheets. One typical per each conduit bank cross-section shall be used. Cable shall be installed in the conduits in such a manner as to maintain the same relative position throughout a run (for example: if a cable is in the bottom east conduit at one end of a run, it shall be in the bottom east conduit throughout the remainder of that run).

Station numbers and/or symbol markers are to be used to denote the limits of a particular conduit bank configuration. The cross section shall illustrate which cables are located in which conduits, the trench width and depth, encasement width and depth, and the direction viewed. Sizes of conduits other than the primary (interconnect) conduits shall be identified on the typical. Conduit bank typical shall conform to the requirements detailed in the [City of Columbus Standard Construction Drawings 4000 and 4001](#).

Conduit and conduit bank call outs shall be as shown in the examples listed below.

Example 1

(1)-2" Conduit w/ (1)-9/C, (5)-7/C, (2)-3/C & (1)-GND
 (1)-2" Conduit w/ (8)-2/C
(1)-3" Conduit w/ (1)-Interconnect Cable
 Encased In Trench = XX'

Example 2

(1)-2" Conduit w/ (1)-9/C, (2)-7/C, (2)-Lighting, & (1)-GND
(1)-2" Conduit w/ (4)-2/C & (2)-Radar Detection Cables
 In Trench = XX'

Example 3

(1)-2" Conduit w/ (1)-9/C, & (1)-GND
(1)-2" Conduit – Empty
 In Trench = XX'

Example 4

(1)-2" Conduit w/ (1)-9/C, (3)-7/C & (1)-GND
(1)-2" Conduit w/ (5)-2/C
 Directional Bored or Drilled Under Pavement = XX'

Example 5

(1)-2" Conduit w/ (1)-9/C, (3)-7/C & (1)-GND

(1)-2" Conduit w/ (5)-2/C

In Trench in Paved Area Type A = XX'

Example 6

CONDUIT BANK #

(4)-3" Conduits (See Interconnect Plan)

(1)-2" Conduit w/ (1)-9/C, (2)-7/C, (2)-Lighting, & (1)-GND

(1)-2" Conduit w/ (4)-2/C & (2)-Video Detection Cables

(1)-1.5" Conduit w/Tracer

Encased Conduit Bank = XX'

Example 7

CONDUIT BANK #

(4)-3" Conduits (See Interconnect Plan)

(1)-2" Conduit w/ (1)-9/C, (2)-7/C, (2)-Lighting, & (1)-GND

(1)-2" Conduit w/ (4)-2/C & (2)-Video Detection Cables

(1)-2" Conduit w/ (1)-Power

(1)-1.5" Conduit w/Tracer

Encased Conduit Bank = XX'

("#" shall correspond to conduit typical section reference number)

13.8.2 Pull Boxes

Each pull box shall be detailed with a leader and an individual callout. Pull box callouts shall list the pull box size and station/offset to an accuracy of a tenth of a foot. Pull box symbols illustrated on the plan shall accurately represent the outside limits (size and shape) of the pull box as listed in **Table 13.6**.

Table 13.6
Pull Box Dimensions

Pull Box Type	Plan Callout Size (in.)	Dimensions To Show on Plan (in.)
Loop detector pull box	12 x 18	12 x 18
Loop detector pull box	13 x 24	13 x 24
Traffic signal pull box	27	35 (dia.)
Interconnect pull box - 1	32	44 (dia.)
Interconnect pull box - 2	48	58 (dia.)

Conduit routing should be as direct as possible between pull boxes. When practical, conduit should enter through the prefabricated knockouts. When entering through the prefabricated knockout results in an excess amount of conduit deflection/bending, core drilling is an acceptable alternative.

Pull box call out examples are listed below.

Example 1

Pull Box, 48", Type 1
Station XXX+XX.X, XX.X' RT.

Example 2

Pull Box, 12"x18"
Station XXX+XX.X, XX.X' RT.

CHAPTER 14: REMOVAL AND REUSE OF TRAFFIC SIGNAL INSTALLATIONS

14.1 Removal of Existing Traffic Signal

Traffic signal removal guidelines for existing installations have been segmented into two categories as listed below. Permanent removal is outside the scope of this document.

- Temporary Removal
- Removal for Replacement

14.1.1 Temporary Removal

When construction operations deactivate a traffic signal for a short time period (less than three weeks) the standard reactivation flash period of 7 days shall be followed except with the following modification.

- SIGNAL AHEAD and NEW signs are not required.

If the out of service time period exceeds 3 weeks, then the re-activation of the signal will be treated as if it were a new installation.

If the road is completely closed to traffic and reopens, then no flashing operation is required.

14.1.2 Removal for Replacement

Layout of a proposed traffic signal should consider the location of the existing signal equipment. When feasible, the proposed traffic signal should be designed to allow the existing traffic signal to remain operational during construction of the new installation. Where conflicts exist, use of temporary traffic signals or an off duty uniformed officer may be required. **Chapter 3** provides additional information with respect to temporary signalization requirements.

A non-active traffic signal head shall be covered and shall not block the view of an active traffic signal head.

The proximity of proposed foundations to existing foundations/supports shall be considered during design. Excavation for a new foundation/support shall not be conducted within 5 ft. of an existing foundation. Excavation between 5 ft. and 8 ft. shall not be conducted without adequate support. Support strategies may involve down guys, base guys, mechanical/crane support, or temporary supports.

14.2 Removal of Existing Traffic Signal – Plan Components

When a traffic signal is specified for removal, a chart similar to **Table 14.1** shall be included detailing the items to be removed and the salvage or disposal status.

Table 14.1
Example Traffic Signal Removal Chart

Quantity	Removed Item Description	Delivered to 1820 E. 17th Ave.	Delivered to 1881 E. 25th Ave.	Disposed of by Project
Lump	Signal Cable and Messenger Wire and Conduit*			X
	Embedded Pole			
	Cabinet/Pole Foundation			
	Pull Box (poly-concrete)			
	Pull Box Casting (i.e. round 27", 32", or 48")			
	Span Mounted Signs			
	Vehicular Signal Head			
	Pedestrian Pushbutton and Signs			
	Pedestrian Signal Head			
	Pole Mounted Cabinet and Controller	X		
	Ground Mounted Cabinet and Controller	X		
	Audible Pedestrian Unit	X		
	Anchor Base Pole	X		
	Pedestrian Pedestal	X		
	Metal Pull Box Lids and Frames (i.e. round 27", 32", or 48")	X		
Lump	Street Name Signs	X		
	Radar Detection Units	X		
	Fiber Optic Termination Panel		X	
	Fiber Optic Splice Enclosure		X	
	Wireless Radio		X	
	Traffic Flow Monitor		X	
	Layer 2 Ethernet Switch		X	
	Ethernet Transceivers (GBIC Modules)		X	

** Designer Note:* Conduit shall be included in the table and removed only if it is within roadway that is to undergo full-depth reconstruction or if it is in direct conflict with proposed signal items or other infrastructure. Otherwise, conduit shall be abandoned.

14.3 Reuse of Traffic Signal Equipment

Reuse of existing traffic signal equipment requires approval from the City of Columbus, City Engineer or appointed designee. When existing signal components are specified for relocation and/or reuse, plan notes shall be included outlining the relocation requirements.

CHAPTER 15: TIMING / PHASING

15.1 Traffic Signal Timing

15.1.1 Yellow Change Interval

The yellow change interval shall be calculated per the ODOT Traffic Engineering Manual, section 403-2.

15.1.2 Red Clearance Interval

The red clearance interval shall be calculated per the ODOT Traffic Engineering Manual, section 403-2 with the exception that, when clearing an exceptionally wide intersection, the red clearance interval should have a duration not exceeding 3 seconds. However, field conditions and engineering judgment may dictate the use of a longer red clearance interval. Additionally, the [Ohio Manual of Uniform Traffic Control Devices](#) indicates the red clearance interval should not exceed 6 seconds. The red clearance interval should not have a duration shorter than 1 second.

15.1.3 Pedestrian Walk Time

The WALKING PERSON indication should be displayed for a minimum of 7 seconds. Shorter times will only be permitted as outlined in the [Ohio Manual of Uniform Traffic Control Devices](#), Section 4E.06.

When accessible pedestrian signal are used, the minimum walk interval shall be 10 seconds for the corresponding phase(s). A 10 second walk interval should also be considered when large groups of pedestrians, or consistent pedestrian traffic consisting of children or mobility impaired pedestrians, are expected to use the crossing(s).

Pedestrian walk times shall be rounded to the next whole second.

15.1.4 Pedestrian Clearance Interval

The pedestrian clearance time should be sufficient to allow a pedestrian crossing in the crosswalk who left the curb or shoulder at the end of the WALKING PERSON (symbolizing WALK) signal indication to travel at a walking speed of 3.5 ft. per second, to the far side detectable warning or to a median of sufficient width for pedestrians to wait. See **Equation 15.3**.

Additionally, the total of the walk interval and pedestrian clearance time should be sufficient to allow a pedestrian crossing in the crosswalk who left the pedestrian detector (or, if no pedestrian detector is present, a

location 6 ft. from the face of the curb or from the edge of the pavement) at the beginning of the WALKING PERSON (symbolizing WALK) signal indication to travel at a walking speed of 3 ft. per second to the far side detectable warning or to the median if a two-stage pedestrian crossing sequence is used. Any additional time that is required to satisfy the conditions of this paragraph should be added to the WALK interval.

For City of Columbus maintained intersections, the pedestrian clearance time shall include: the flashing DON'T WALK interval, the YELLOW interval and the all RED clearance (All Red) interval prior to the beginning of conflicting vehicular movements. Walk and pedestrian clearance time relationships are graphically illustrated in **Figure 15.1**

Equation 15.3
(Pedestrian Clearance Time)

$$\text{Ped Clearance Time} = \frac{\text{Crossing Distance}}{\text{Walking Speed}}$$

15.1.5 Pedestrian Change Interval (Flashing DON'T WALK)

The pedestrian change interval (also known as Flashing DON'T WALK or FDW) shall be calculated as the countdown displayed on the pedestrian signal head. The pedestrian change interval shall end as soon as the corresponding yellow change interval begins as illustrated in **Figure 15.1**. The pedestrian change interval is the value that is included in the timing chart in the plans. See **Equation 15.4**.

Pedestrian change times shall be rounded to the next whole second.

Equation 15.4
(Pedestrian Change Interval)

$$\text{Ped Change Interval} = \text{Ped Clearance} - \text{Yellow Change} - \text{Red Clearance}$$

Figure 15.1
Pedestrian Intervals

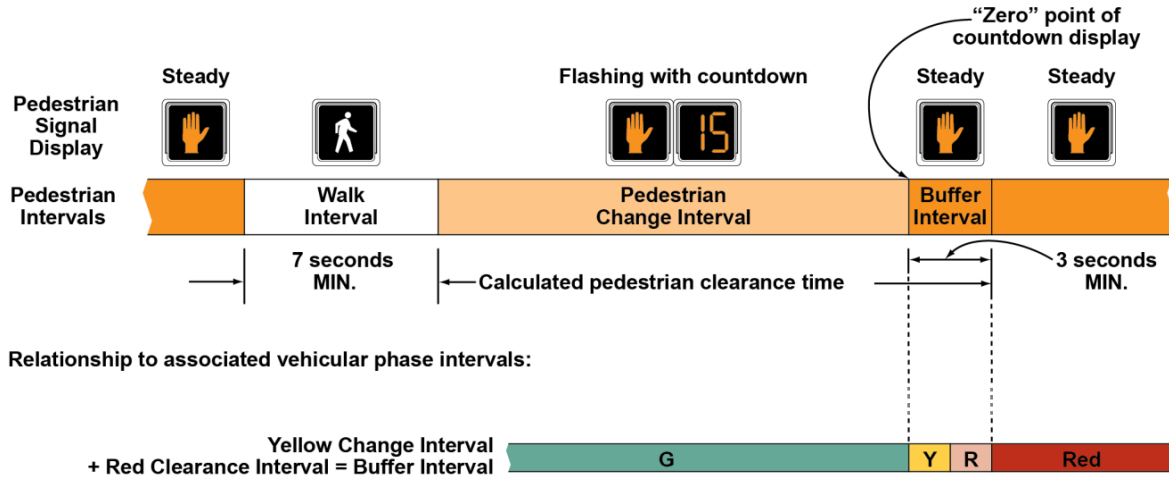

Legend

- G= Green Interval
- Y = Yellow change interval (min. 3 seconds).
- R= Red clearance interval (All Red)
- Red= Red because conflicting traffic has been released

Figure 15.2
Pedestrian Clearance and Walk Interval Example #1

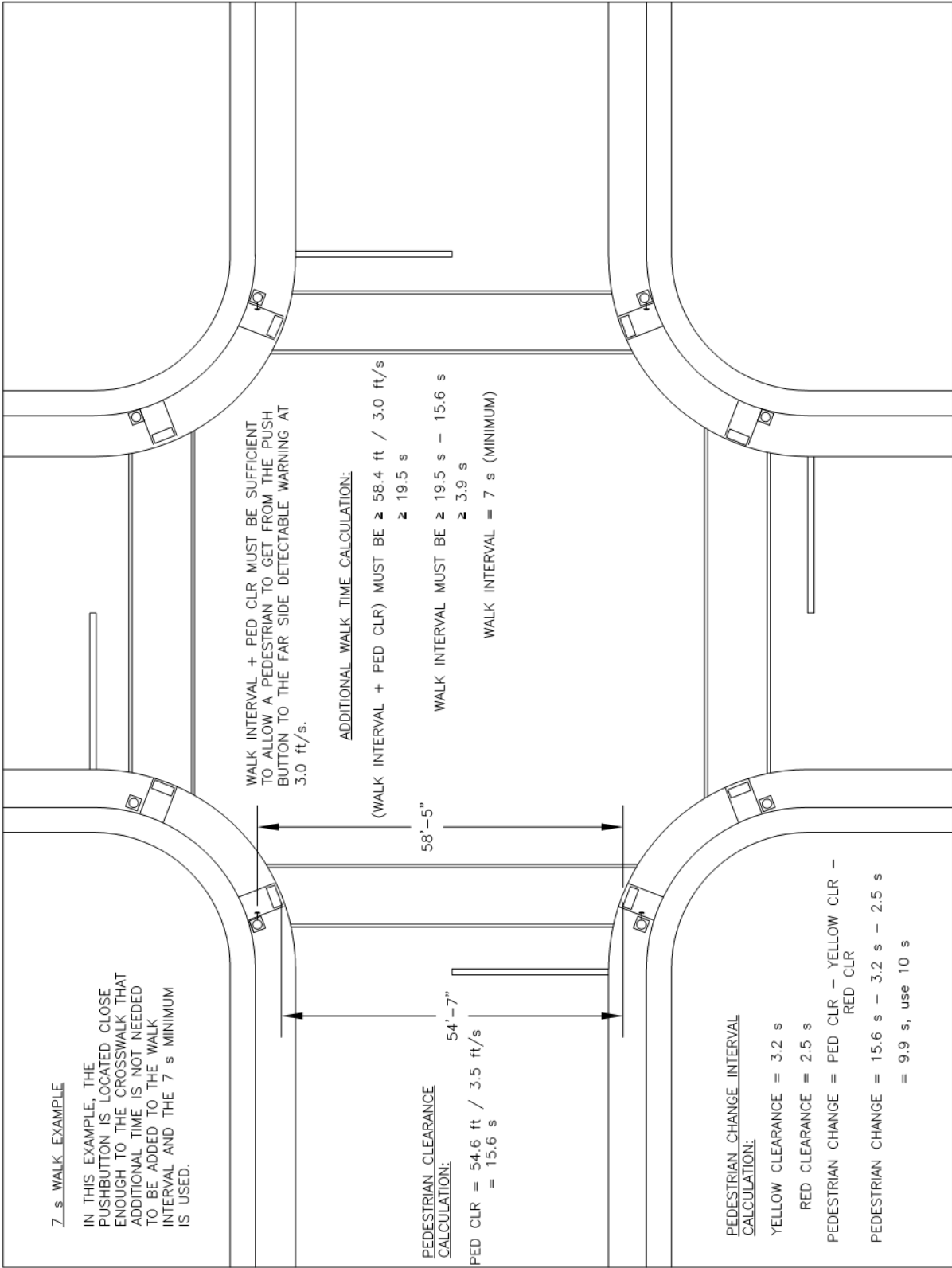

Figure 15.3
Pedestrian Clearance and Walk Interval Example #2

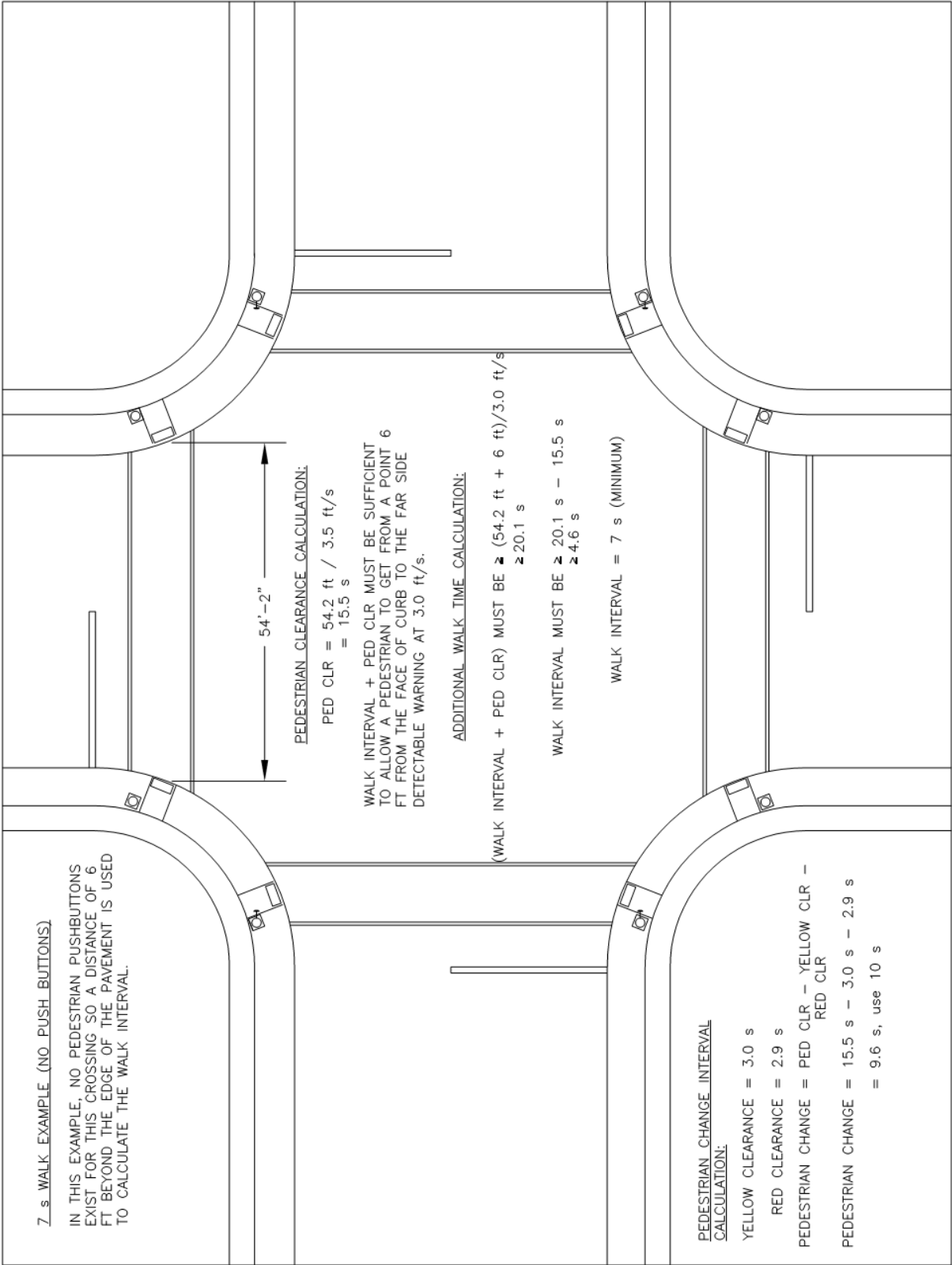
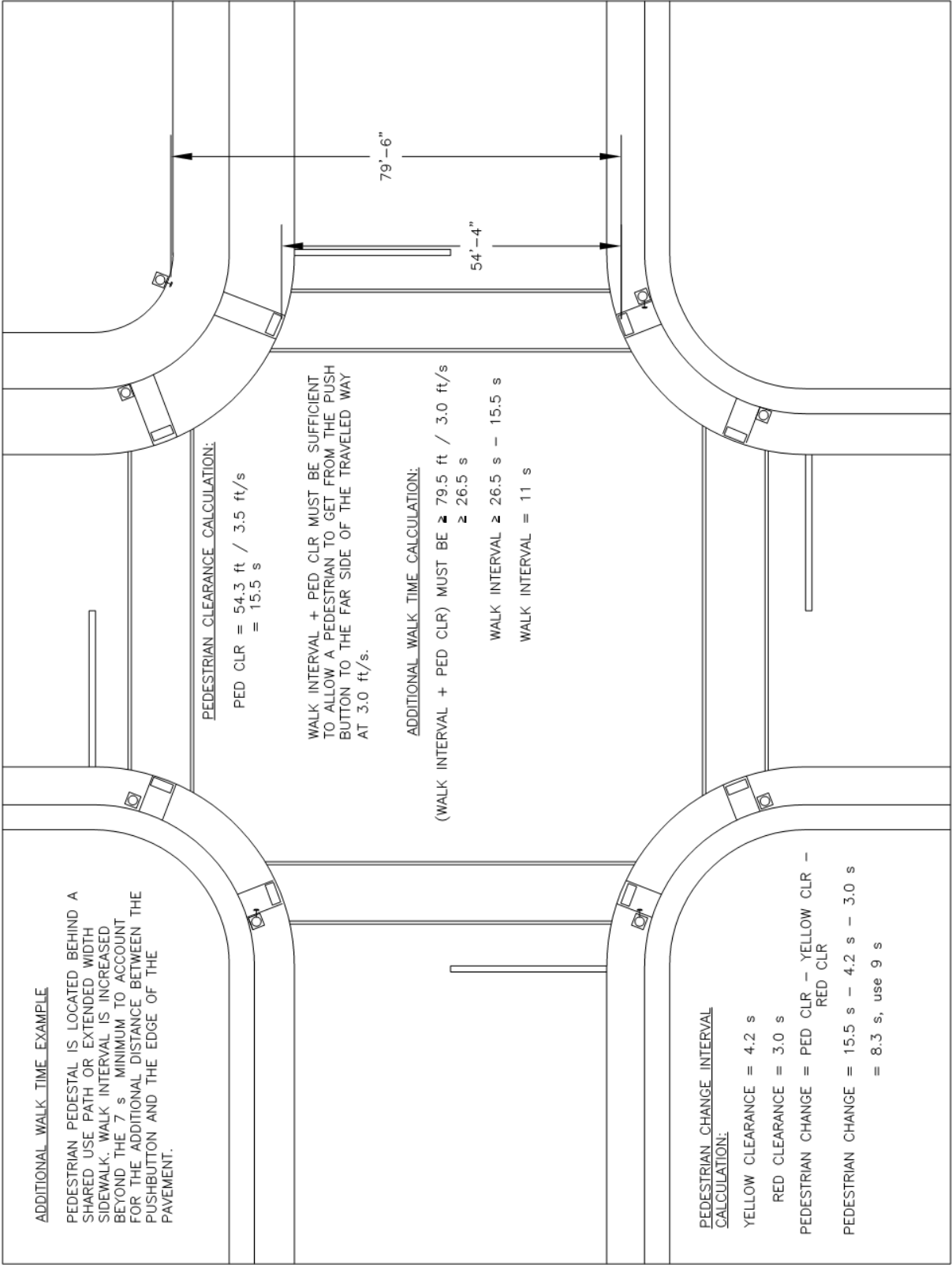

Figure 15.4
Pedestrian Clearance and Walk Interval Example #3



15.1.6 Minimum Initial Green Time

Minimum initial green time on the major street (pedestrian and minimum vehicular recall “on”) shall be set to clear vehicles queued between the stop line and the first advanced detector as well as accommodate pedestrian clearance times associated with the phase. Time to discharge the initial queue should be based on a 2 second start up time, a 2 second vehicle headway and an average vehicle spacing of 25 ft. A minimum value of 20 seconds should be specified, unless the sum of the walk and pedestrian change is greater, then that value shall be used.

Minimum initial green time for minor street or left turn movements (pedestrian and minimum vehicular recall “off”) shall be set based on volume demand and fall within the following ranges listed below. Use the lowest practical value.

Minimum initial green times shall be in whole numbers.

- Left turn phase: 7 to 10 seconds
- Minor street: 7 to 15 seconds, (Typically 10 seconds)

15.1.7 Maximum Green Time

Maximum green time for each phase shall be set to accommodate the vehicle and pedestrian demand for each approach considering cycle length, total volume demand for the intersection and coordination requirements.

Traffic signal timing software packages including, but not limited to: Highway Capacity Software and Synchro/Simtraffic can be used to assist with the development of maximum green times.

Maximum initial green times shall be in whole numbers.

15.1.8 Passage and Extension Time

15.1.8.1 Posted Speed 35 MPH or Less

When the posted speed is 35 miles per hour or less the passage time shall be set to 3.7 seconds and detector unit extension time shall not be used.

15.1.8.2 Posted Speed 40 MPH or Greater

The information provided in the following paragraphs is applicable only when using video detection or inductive loop detection. For radar detection, passage time shall be set at 1.0 second.

For video detection or inductive loop detection, vehicle detectors shall be located per the placement details outlined in **Section 9.3.9** to provide for dilemma zone protection. When available, actual vehicle speeds should be used to determine the dilemma zone protection range with the lower end set to the 15th percentile speed and upper range set to the 85th percentile speed. If speed data is not available, 35 miles per hour shall be used as the lower threshold and the posted speed shall be used as the upper threshold.

Passage time shall be established by determining the time it takes to get from the near detector to the intersection (stop line, near side) at the 15th percentile (or 35 MPH) speed.

In combination with the passage time, the detector unit extension function is used to get a vehicle from the far detector to the near detector at the low speed value of the dilemma range (15th percentile or 35 MPH). Extension time is added to the passage time and is only applied to the far detector. Example calculations are provided.

Dilemma Zone Example #1

85th Percentile Speed (Posted Speed) = 45 MPH

15th Percentile Speed = 35 MPH

Far detector located at 330 ft. (see **Section 9.3.9**)

Near detector located at 110 ft. (see **Section 9.3.9**)

Establish time between detectors at 35 MPH

$330 \text{ ft.} - 110 \text{ ft.} = 220 \text{ ft.}$

$220 \text{ ft.} \div 51 \text{ ft./sec. (35 MPH} \times 1.467) = 4.3 \text{ sec.}$

Passage Time = $110 \text{ ft.} \div 51 \text{ ft./sec.} = 2.2 \text{ sec.}$

Extension Time = $4.3 \text{ sec.} - 2.2 \text{ sec.} = 2.1 \text{ sec.}$

Figure 15.5
Dilemma Zone Example #1

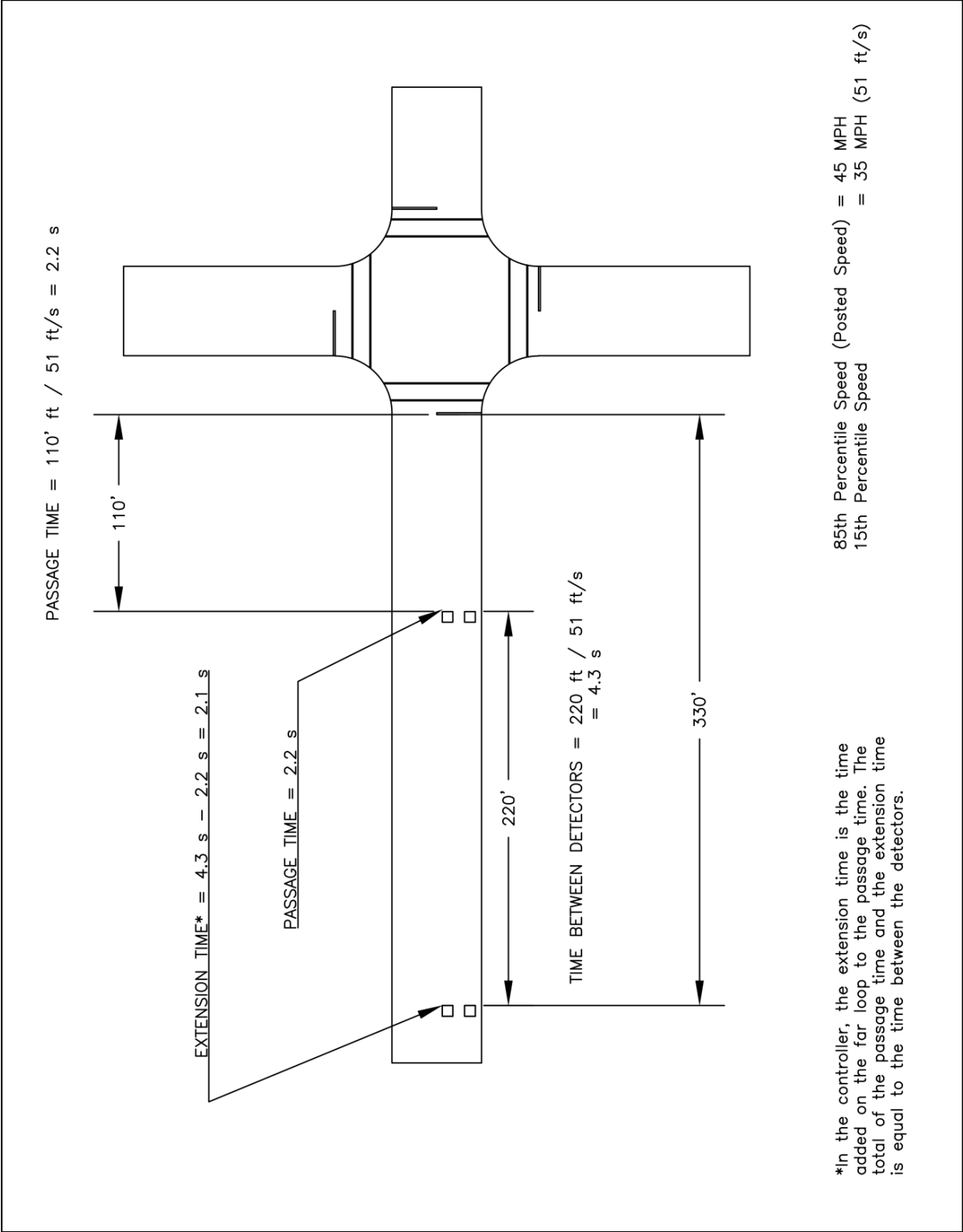

Dilemma Zone Example #2

Dilemma zone range = 45 MPH to 55 MPH

85th percentile speed = 55 MPH15th percentile speed = 45 MPHFar detector located at 403 ft. (see **Section 9.3.9**)Near detector located at 110 ft. (see **Section 9.3.9**)

Establish time between detectors at 45 MPH

403 ft. – 110 ft. = 293 ft.

293 ft. ÷ 66 ft./sec. (45 MPH x 1.467) = 4.4 sec.

Passage Time = 110 ft. ÷ 66 ft./sec. = 1.7 sec.Extension Time = 4.4 sec. – 1.7 sec. = 2.7 sec.

15.2 Traffic Signal Phasing

15.2.1 Phasing Directions

Traffic signal phasing examples are illustrated in **Figure 15.6** through **Figure 15.14**, detailing 2-phase and 8-phase configurations and assignments. These figures are only examples and must be tailored to accommodate the individual characteristics of each application. The phase direction assignments illustrated in these examples shall be used unless otherwise directed by the City of Columbus, City Engineer or appointed designee.

15.2.2 Vehicle and Pedestrian Recall and Memory

For major street phase(s); pedestrian recall, minimum vehicular recall and memory should be set to “ON” in the controller. For minor street phase(s) with pedestrian pushbuttons and presence detection or left-turn phase(s) with stop line detection; pedestrian recall, vehicular recall and memory should be set to “OFF”.

15.2.3 Left-turn Phasing

Application of a dedicated left-turn phase shall be based on the results of an analysis performed by the traffic signal designer or as determined in a preliminary engineering study or other traffic study.

Protected/Permissive left-turn phasing should be considered under any of the following conditions:

- 5 or more left-turn crashes per million left-turn vehicles.

- When capacity analysis from Highway Capacity Software (HCS) or Synchro analysis indicates a poor level-of-service without a left-turn phase.
- If the left-turn volume exceeds 240 vehicles/hour.
- If the product of (left-turn volume x opposing through traffic) exceeds: 50,000 with 1 opposing lane, 90,000 with 2 opposing lanes, and 110,000 with 3 opposing lanes (Reference the 2010 Highway Capacity Manual Chapter 31, Page 87), and the left-turn volume is greater than 2 vehicles per cycle, a left-turn phase should be considered. Analyses should be based on peak hour data.
- A study shows that left-turn queues are not clearing in one cycle for greater than ten consecutive minutes.

If the above conditions are not met, permissive only left turn operation should be considered.

Permissive left turn operation (Protected/Permissive or Permissive Only) may be used only if a sight distance analysis by the designer demonstrates that left-turning vehicles have adequate visibility of oncoming vehicles.

Protected Only left-turn phasing *shall* be used under the following conditions:

- There are two or more left-turn lanes on an approach with opposing through traffic.
- Sight distance limitations exist, or are expected, due to negative offset of opposing left-turn lanes or skewed intersection geometry.

The use of Protected Only phasing to address misaligned left-turn lanes or other intersection geometry-related conditions requires advance authorization from the City of Columbus City Engineer or appointed designee. Solutions such as realignment of opposing left-turn lanes to provide zero or positive offset shall be explored before Protected Only phasing will be considered.

Protected Only left-turn phasing *should* be considered under the following conditions:

- When protected/permissive left-turn phasing is in operation and a continued crash rate of 5 or more left-turn crashes per million left-turn vehicles occur.
- The left-turn movement must cross three or more opposing through

lanes.

- The left-turn movement must cross two or more opposing through lanes and the posted speed limit (or 85th percentile speed if available) is 45 mph or greater.

15.2.4 Split Phasing

Split phasing is sometimes used when traditional intersection phasing would result in conflicts with simultaneous movements.

Examples include:

- Poor lane alignment
- Offset intersections
- Overlapping left turns
- A significant imbalance in side street volumes
- When the left turn movement of a through/left lane is required to operate under protected only mode.

The use of split phasing is discouraged and requires advance authorization from the City of Columbus City Engineer or appointed designee. Other solutions to the intersection geometry-related conditions listed above should be explored before split phasing will be considered.

15.2.5 Yellow Trap

Yellow trap is a term used to describe a condition which occurs during certain yellow change intervals. A yellow trap occurs when a left-turning driver is presented a yellow indication, but the opposing through movement remains green. The left-turning driver incorrectly assumes the opposing traffic is also presented a yellow indication and may execute a left-turn movement without a sufficient gap. This condition can occur under the following scenarios:

- When permissive left-turns are allowed in the opposing direction from a major street left-turn phase, and the left-turn phase is allowed to be displayed following the opposing thru phase (lagging left-turn phase).
- During a transition into preemption, with or without Protected/Permissive Left-turn signal face displays and the sequence is changing from a concurrent through movement to a through and left-turn movement in the same direction of travel (lagging left-turn).

The following are examples of methods which can be used to resolve the yellow trap condition:

- Left-turn signal face displays on an approach to the intersection where yellow trap occurs can be changed to Protected Only displays.
- Opposing movements may be reconfigured to provide exclusive or “split” phase sequencing.
- During a transition into preemption, the controller sequence may be designed such that both directions of travel transition to red before the display of a green indication on a single approach. This ensures that there is a simultaneous display of CIRCULAR YELLOW on both approaches prior to the display of green on a single approach.

The signal plans shall contain plan notes to omit calls to protected/permitted left-turn phases as necessary to resolve yellow trap conditions. The traffic signal controller programming shall incorporate this information to resolve yellow trap conditions. Additionally, left-turn prevention wiring diodes shall be used to prevent protected/permissive left-turn yellow trap scenarios.

The use of W25-1 and W25-2 signs (ONCOMING TRAFFIC HAS EXTENDED GREEN and ONCOMING TRAFFIC MAY HAVE EXTENDED GREEN, respectively) are not recommended by the City of Columbus to resolve a yellow trap condition.

Whenever preemption is provided, careful consideration must be given to the design of the signal sequence under all modes to prevent the display of yellow trap.

15.2.6 Lead/Lag Phasing

Lead phasing refers to left turns being served prior to the opposing through phase. Lag phasing refers to left turns being served after the opposing through phase. When lead/lag phasing is used, the leading left turn phase shall be protected only to prevent a yellow trap condition associated with the lagging left turn phase.

Lead/Lag left turn phasing is sometimes used when the vehicle paths from opposing left turn movements conflict or left turn lanes do not align (negative offset). In all cases when used, caution should be taken to avoid a yellow trap condition.

The use of lead/lag phasing requires advance authorization from the City of Columbus City Engineer or appointed designee. Other solutions to correct an overlapping left turn path condition or misaligned left turn lanes

should be explored before proposing the use of lead/lag phasing.

15.2.7 Overlap Phasing

When used, the overlapping movements shall be identified on the phasing diagram and defined in the field wiring hookup chart. The load switch shall also be identified in the field wiring hookup chart.

Protected right turn indications that are assigned to a single non-conflicting left turn phase are considered overlaps. In order to utilize proper approach monitoring, each protected right turn indication is wired to its own load switch which shall be identified in the field wiring hookup chart.

15.3 Plan Components

15.3.1 Phasing Diagram

A phasing diagram shall be furnished detailing the sequence of both vehicular and pedestrian movements. Phasing diagrams shall be customized to each intersection and accurately reflect the number of lanes on each approach. Only active movements shall be illustrated in an individual phasing circle. Example phasing diagrams are detailed in **Figure 15.6** through **Figure 15.14**.

15.3.2 Field Wiring Hook-up Chart

A field wiring hook-up chart shall be furnished detailing the relationship between individual vehicular and pedestrian signal indications and their associated controller phase. Example field wiring hook-up charts are detailed in **Figure 15.6** through **Figure 15.14**.

15.3.3 Timing Chart

Example timing charts are illustrated in **Table 15.1** through **Table 15.4**. **Section 15.1** outlines computational procedures for individual components.

Figure 15.6
2 Phase Example
East-West Mainline

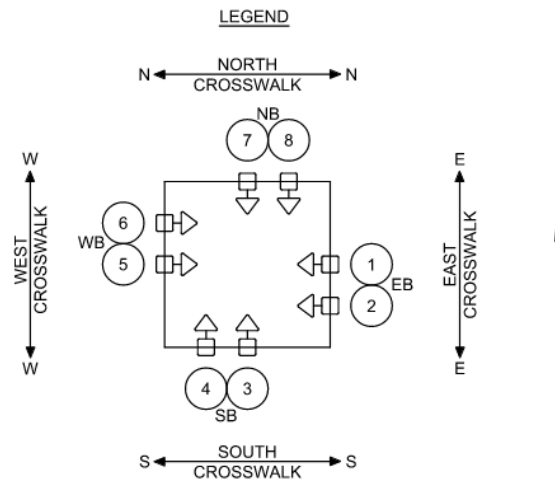
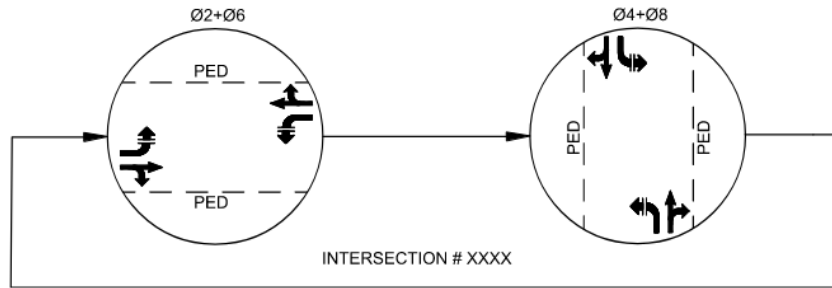

FIELD WIRING HOOK-UP CHART							
SIGNAL HEAD #	INDICATION	FIELD TERMINAL	FLASH	SIGNAL HEAD #	INDICATION	FIELD TERMINAL	FLASH
1,2 (EB)	R	Ø6 R	R	N (NORTH)	WALK	G (Ø2)-W	OFF
	Y	Ø6 Y			DON'T WALK	R (Ø2)-DW	
	G	Ø6 G		E (EAST)	WALK	G (Ø8)-W	OFF
3,4 (SB)	R	Ø4 R	R	S (SOUTH)	DON'T WALK	R (Ø8)-DW	
	Y	Ø4 Y			WALK	G (Ø6)-W	OFF
	G	Ø4 G		W (WEST)	DON'T WALK	R (Ø4)-DW	
5,6 (WB)	R	Ø2 R	R	W (WEST)	WALK	G (Ø4)-W	OFF
	Y	Ø2 Y			DON'T WALK	R (Ø4)-DW	
	G	Ø2 G		7,8 (NB)	R	R	Ø8 R
Y	Ø8 Y	Y	Ø8 Y				
G	Ø8 G	G	Ø8 G				

Figure 15.7
2 Phase Example
North-South Mainline

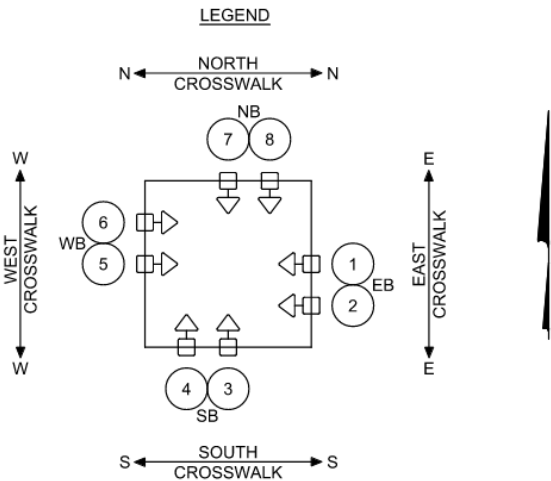
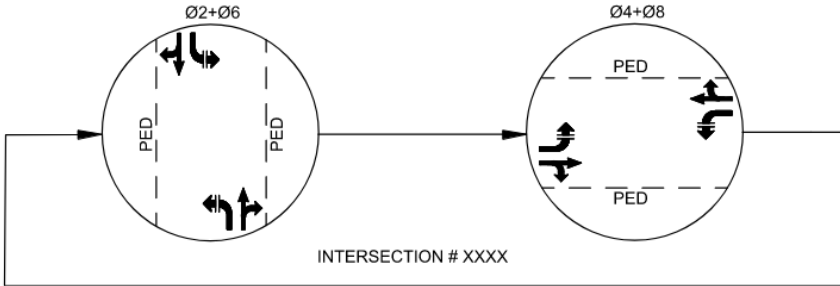

FIELD WIRING HOOK-UP CHART							
SIGNAL HEAD #	INDICATION	FIELD TERMINAL	FLASH	SIGNAL HEAD #	INDICATION	FIELD TERMINAL	FLASH
1,2 (EB)	R	Ø8 R	R	N (NORTH)	WALK	G (Ø4)-W	OFF
	Y	Ø8 Y			DON'T WALK	R (Ø4)-DW	
	G	Ø8 G		E (EAST)	WALK	G (Ø6)-W	OFF
3,4 (SB)	R	Ø2 R	R	S (SOUTH)	DON'T WALK	R (Ø6)-DW	
	Y	Ø2 Y			WALK	G (Ø8)-W	OFF
	G	Ø2 G		W (WEST)	WALK	G (Ø2)-W	
5,6 (WB)	R	Ø4 R	R	W (WEST)	DON'T WALK	R (Ø2)-DW	
	Y	Ø4 Y			S (SOUTH)	WALK	G (Ø8)-W
	G	Ø4 G		N (NORTH)		WALK	G (Ø4)-W
7,8 (NB)	R	Ø6 R	R	N (NORTH)	DON'T WALK	R (Ø4)-DW	
	Y	Ø6 Y			WALK	G (Ø6)-W	OFF
	G	Ø6 G		E (EAST)	WALK	G (Ø6)-W	

Figure 15.8
8 Phase with RT Overlap Example
East-West Mainline

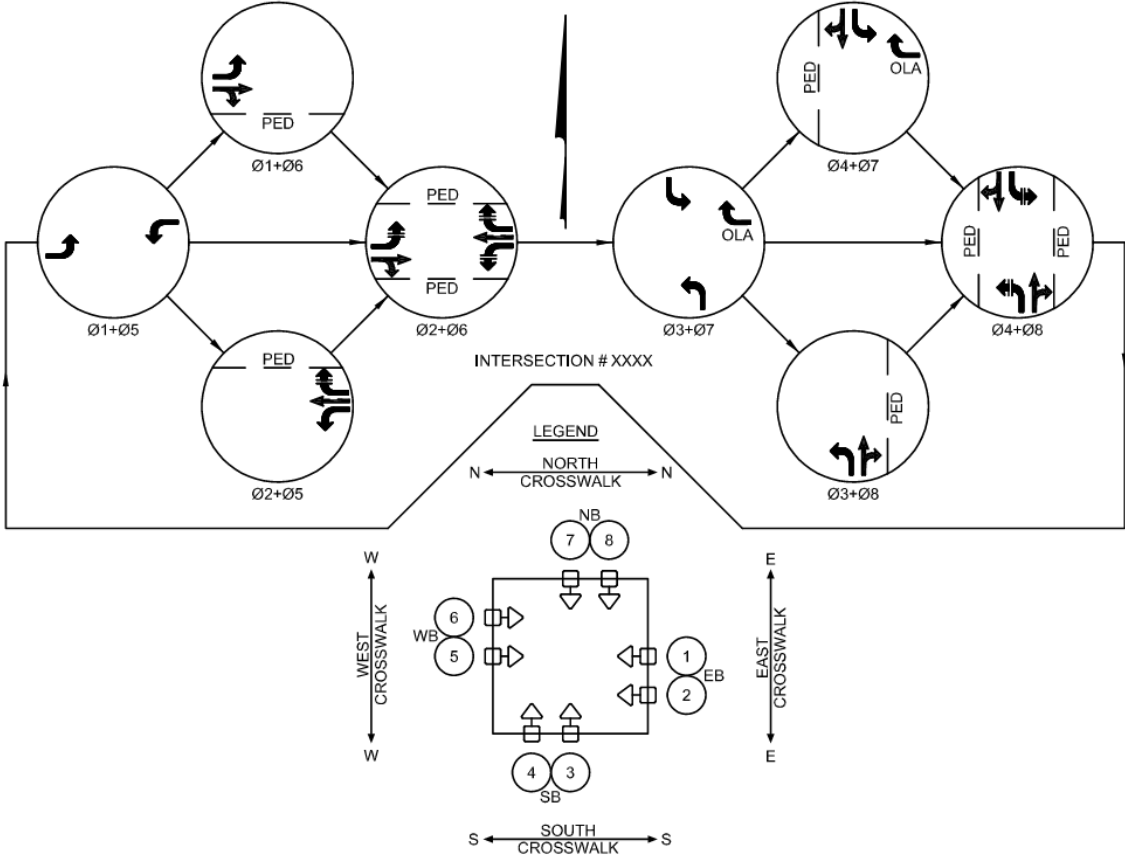

FIELD WIRING HOOK-UP CHART								
SIGNAL HEAD #	INDICATION	FIELD TERMINAL	FLASH	SIGNAL HEAD #	INDICATION	FIELD TERMINAL	FLASH	
1 (EBLT)	R	Ø6 R	R	6 (WBRT)	R	Ø2 R	R	
	Y	Ø6 Y			Y	Ø2 Y		
	G	Ø6 G			G	Ø2 G		
	↔	Ø1 Y			↔	OLA Y		
	↔	Ø1 G			↔	OLA G		
2 (EB)	R	Ø6 R	R	7 (NBLT)	R	Ø8 R	R	
	Y	Ø6 Y			Y	Ø8 Y		
	G	Ø6 G			G	Ø8 G		
	↔	Ø4 Y			↔	Ø3 Y		
3 (SBLT)	R	Ø4 R	R	8 (NB)	R	Ø8 R	R	
	Y	Ø4 Y			Y	Ø8 Y		
	G	Ø4 G			G	Ø8 G		
	↔	Ø7 Y			↔	Ø3 G		
4 (SB)	R	Ø4 R	R	N (NORTH)	WALK	G (Ø2)-W	OFF	
	Y	Ø4 Y			DON'T WALK	R (Ø2)-DW		
	G	Ø4 G			WALK	G (Ø8)-W		
5 (WBLT)	R	Ø2 R	R	E (EAST)	DON'T WALK	R (Ø8)-DW	OFF	
	Y	Ø2 Y			WALK	G (Ø6)-W		
	G	Ø2 G		S (SOUTH)	WALK	G (Ø4)-W	OFF	
	↔	Ø5 Y			DON'T WALK	R (Ø6)-DW		
	↔	Ø5 G			W (WEST)	WALK		G (Ø4)-W
	↔	Ø5 G				DON'T WALK		R (Ø4)-DW

OLA = Ø7 OLA = LS9

Figure 15.9
Split Phase Example
East-West Mainline
Split Phase Side Street

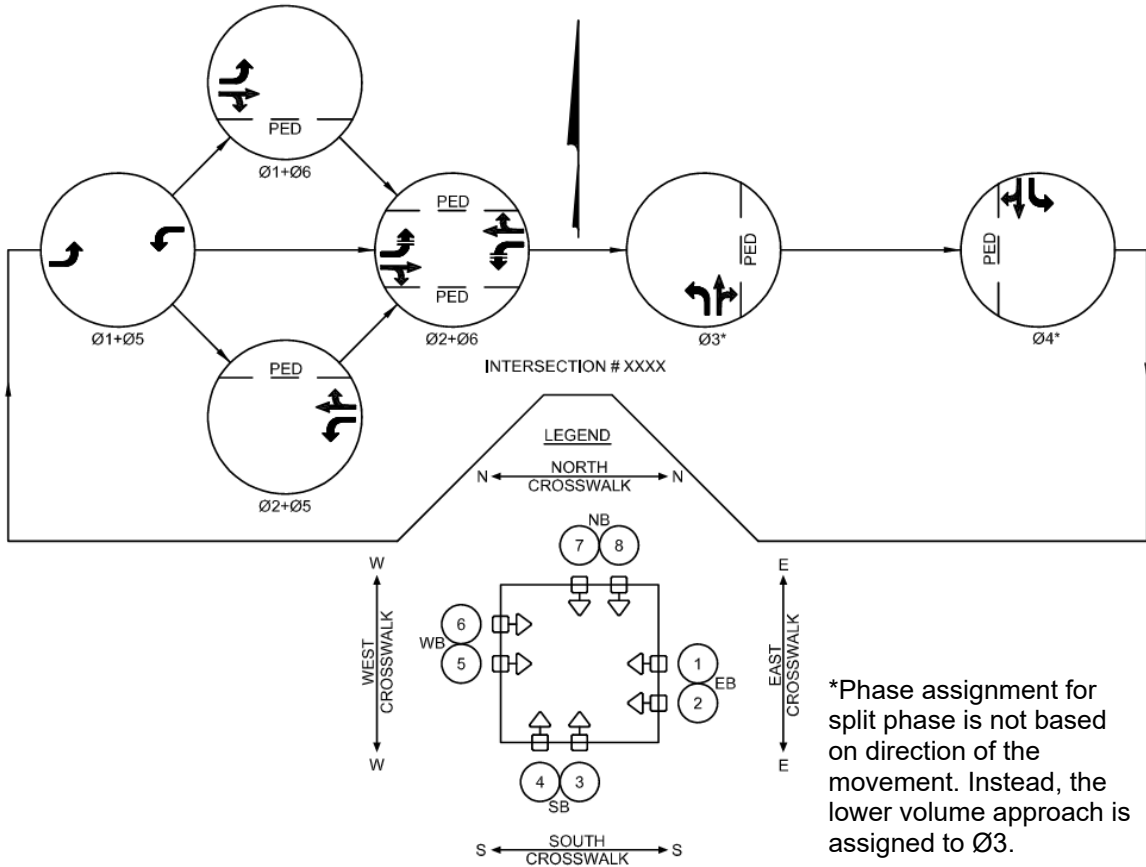

*Phase assignment for split phase is not based on direction of the movement. Instead, the lower volume approach is assigned to Ø3.

FIELD WIRING HOOK-UP CHART							
SIGNAL HEAD #	INDICATION	FIELD TERMINAL	FLASH	SIGNAL HEAD #	INDICATION	FIELD TERMINAL	FLASH
1 (EBLT)	R	Ø6 R	R	6 (WB)	R	Ø2 R	R
	Y	Ø6 Y			Y	Ø2 Y	
	G	Ø6 G			G	Ø2 G	
	→	Ø1 Y			→	Ø3 R	
2 (EB)	→	Ø1 G	R	7 (NBLT)	Y	Ø3 Y	R
	R	Ø6 R			G	Ø3 G	
	Y	Ø6 Y			→	Ø3 G	
	G	Ø6 G					
3 (SBLT)	R	Ø4 R	R	8 (NB)	R	Ø3 R	R
	Y	Ø4 Y			Y	Ø3 Y	
	G	Ø4 G			G	Ø3 G	
	→	Ø4 G					
4 (SB)	R	Ø4 R	R	N (NORTH)	WALK	G (Ø2)-W	OFF
	Y	Ø4 Y			DON'T WALK	R (Ø2)-DW	
	G	Ø4 G					
	→	Ø4 G					
5 (WBLT)	R	Ø2 R	R	E (EAST)	WALK	G (Ø3)-W	OFF
	Y	Ø2 Y			DON'T WALK	R (Ø3)-DW	
	G	Ø2 G					
	→	Ø5 Y					
	→	Ø5 G		S (SOUTH)	WALK	G (Ø6)-W	OFF
					DON'T WALK	R (Ø6)-DW	
				W (WEST)	WALK	G (Ø4)-W	OFF
					DON'T WALK	R (Ø4)-DW	

Figure 15.10
8 Phase with RT Overlap Example
North-South Mainline

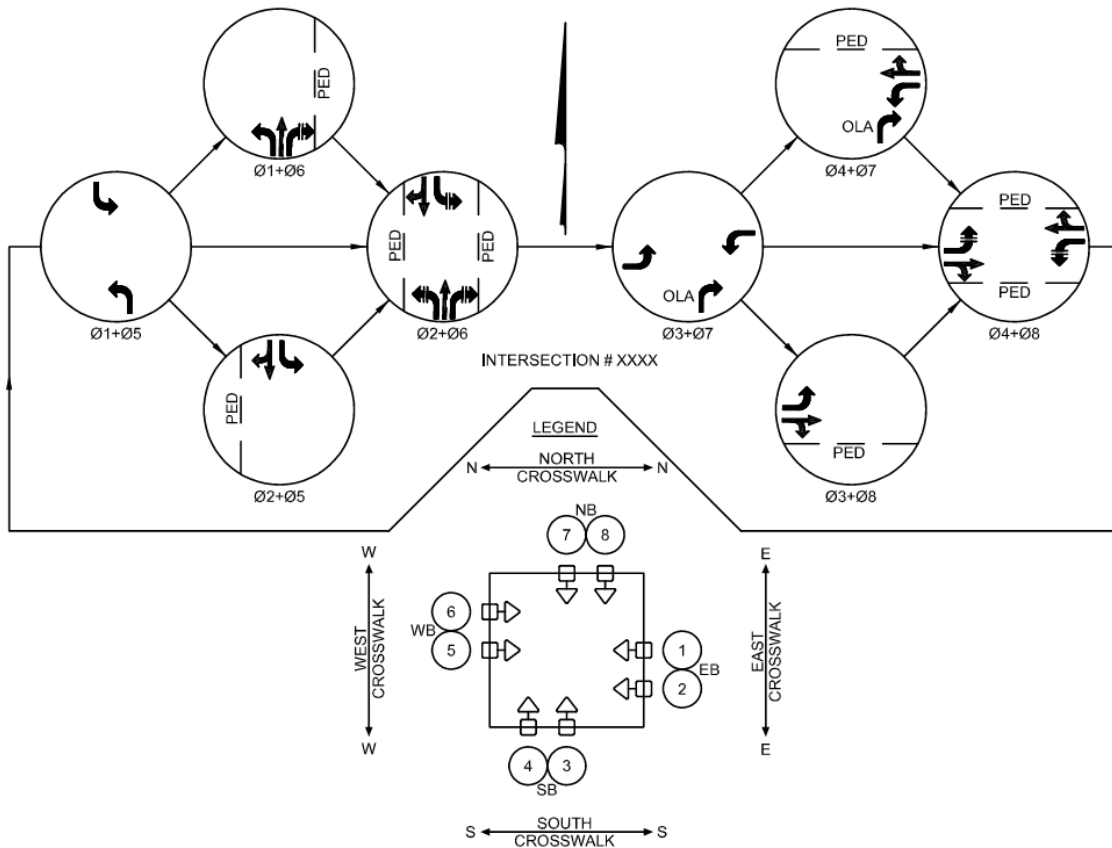

FIELD WIRING HOOK-UP CHART							
SIGNAL HEAD #	INDICATION	FIELD TERMINAL	FLASH	SIGNAL HEAD #	INDICATION	FIELD TERMINAL	FLASH
1 (EBLT)	R	Ø8 R	R	6 (WB)	R	Ø4 R	R
	Y	Ø8 Y			Y	Ø4 Y	
	G	Ø8 G			G	Ø4 G	
	←Y	Ø3 Y			R	Ø6 R	
	←G	Ø3 G			Y	Ø6 Y	
2 (EB)	R	Ø8 R	R	7 (NBLT)	G	Ø6 G	R
	Y	Ø8 Y			←Y	Ø1 Y	
	G	Ø8 G			←G	Ø1 G	
3 (SBLT)	R	Ø2 R	R	8 (NBRT)	R	Ø6 R	R
	Y	Ø2 Y			Y	Ø6 Y	
	G	Ø2 G			G	Ø6 G	
	←Y	Ø5 Y			←Y	OLA Y	
	←G	Ø5 G			←G	OLA G	
4 (SB)	R	Ø2 R	R	N (NORTH)	WALK	G (Ø4)-W	OFF
	Y	Ø2 Y			DON'T WALK	R (Ø4)-DW	
	G	Ø2 G		E (EAST)	WALK	G (Ø6)-W	OFF
R	Ø4 R	DON'T WALK	R (Ø6)-DW				
5 (WBLT)	Y	Ø4 Y	R	S (SOUTH)	WALK	G (Ø8)-W	OFF
	G	Ø4 G			DON'T WALK	R (Ø8)-DW	
	←Y	Ø7 Y		W (WEST)	WALK	G (Ø2)-W	OFF
	←G	Ø7 G			DON'T WALK	R (Ø2)-DW	

OLA = Ø7 OLA = LS9

Figure 15.11
Split Phase Example
North-South Mainline
Split Phase Side Street

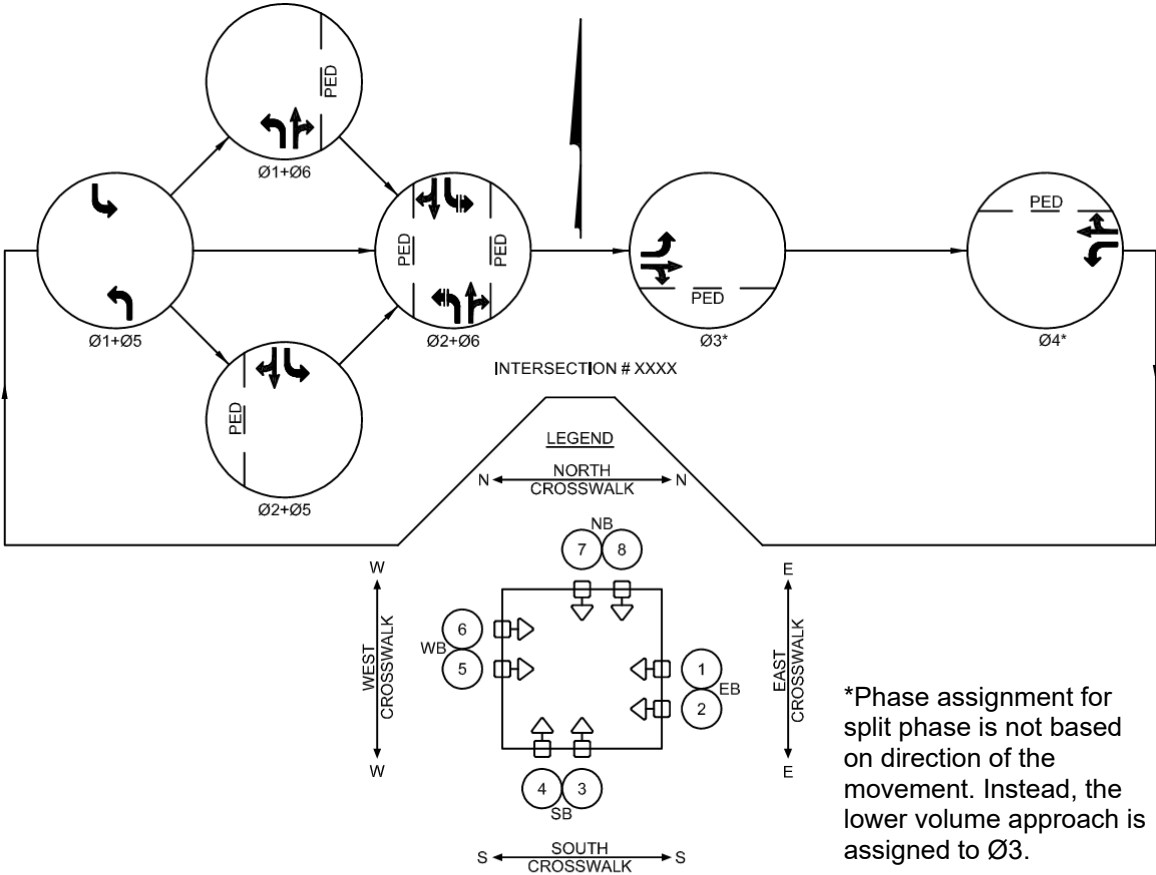

*Phase assignment for split phase is not based on direction of the movement. Instead, the lower volume approach is assigned to Ø3.

FIELD WIRING HOOK-UP CHART							
SIGNAL HEAD #	INDICATION	FIELD TERMINAL	FLASH	SIGNAL HEAD #	INDICATION	FIELD TERMINAL	FLASH
1 (EBLT)	R	Ø3 R	R	6 (WB)	R	Ø4 R	R
	Y	Ø3 Y			Y	Ø4 Y	
	G	Ø3 G			G	Ø4 G	
	⚡	Ø3 G		⚡	Ø1 G		
2 (EB)	R	Ø3 R	R	7 (NBLT)	R	Ø6 R	R
	Y	Ø3 Y			Y	Ø6 Y	
	G	Ø3 G			G	Ø6 G	
⚡	Ø5 Y	⚡	Ø1 Y				
3 (SBLT)	R	Ø2 R	R	8 (NB)	R	Ø6 R	R
	Y	Ø2 Y			Y	Ø6 Y	
	G	Ø2 G			G	Ø6 G	
	⚡	Ø5 G		⚡	Ø1 G		
4 (SB)	R	Ø2 R	R	N (NORTH)	WALK	G (Ø4)-W	OFF
	Y	Ø2 Y		E (EAST)	WALK	G (Ø6)-W	OFF
	G	Ø2 G		⚡	Ø1 G		
5 (WBLT)	R	Ø4 R	R	S (SOUTH)	WALK	G (Ø3)-W	OFF
	Y	Ø4 Y		⚡	Ø1 Y		
	G	Ø4 G		⚡	Ø1 G		
	⚡	Ø4 G		⚡	Ø1 G		
				W (WEST)	WALK	G (Ø2)-W	OFF
					⚡	R (Ø2)-DW	OFF

Figure 15.12
N-S Lead-Lag Phasing Example 1
North-South Mainline

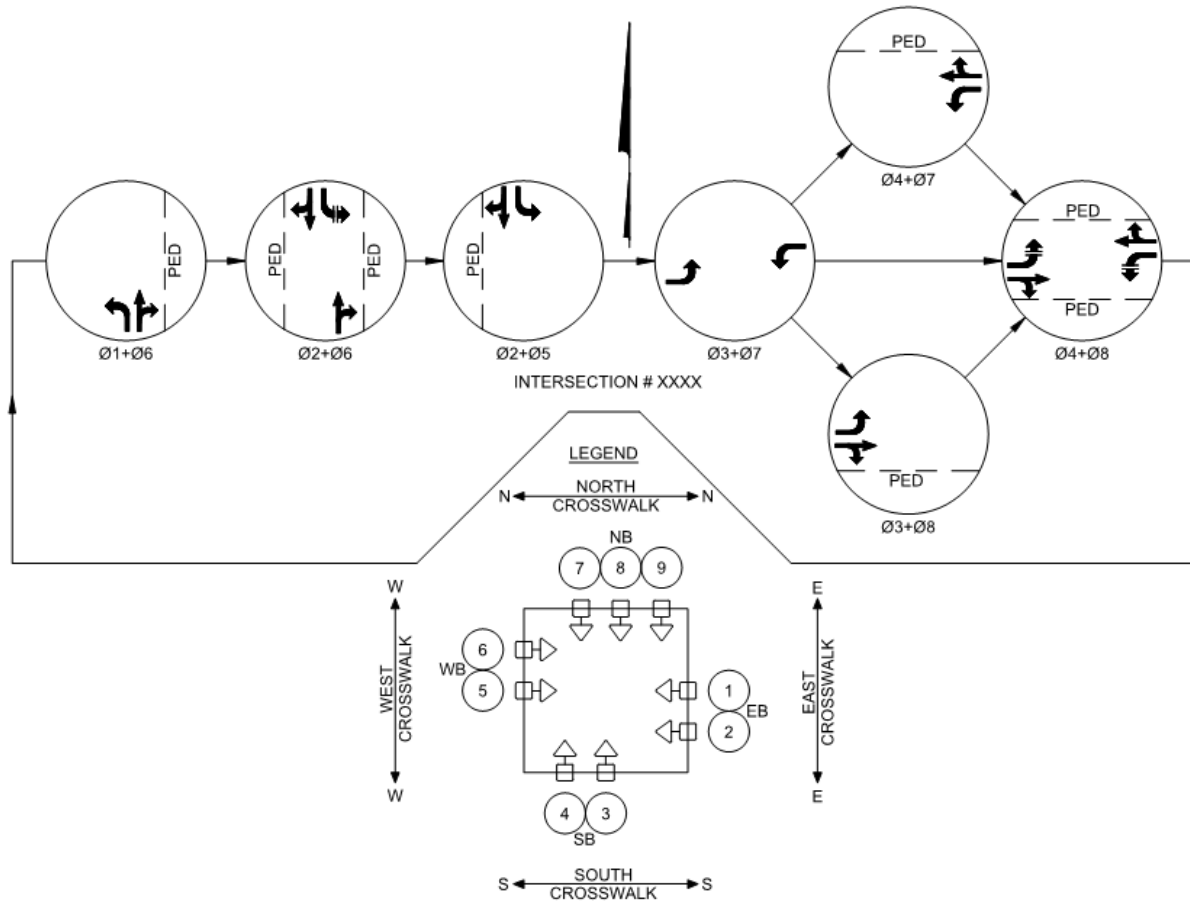

FIELD WIRING HOOK-UP CHART							
SIGNAL HEAD #	INDICATION	FIELD TERMINAL	FLASH	SIGNAL HEAD #	INDICATION	FIELD TERMINAL	FLASH
1 (EBLT)	R	Ø8 R	R	6 (WB)	R	Ø4 R	R
	Y	Ø8 Y			Y	Ø4 Y	
	G	Ø8 G			G	Ø4 G	
	←Y	Ø3 Y		←G	Ø1 G		
2 (EB)	R	Ø8 R	R	7 (NBLT)	←Y	Ø1 Y	R
	Y	Ø8 Y			←G	Ø1 G	
	G	Ø8 G		8,9 (NB)	R	Ø6 R	R
←Y	Ø5 Y	Y	Ø6 Y				
3 (SBLT)	R	Ø2 R	R	G	Ø6 G	OFF	
	Y	Ø2 Y		N (NORTH)	WALK		G (Ø4)-W
	←Y	Ø5 Y		DONT WALK	R (Ø4)-DW		
	←G	Ø5 G		E (EAST)	WALK		G (Ø6)-W
4 (SB)	R	Ø2 R	R	DONT WALK	R (Ø6)-DW	OFF	
	Y	Ø2 Y		S (SOUTH)	WALK		G (Ø8)-W
	G	Ø2 G		DONT WALK	R (Ø8)-DW		
5 (WBLT)	R	Ø4 R	R	W (WEST)	WALK	G (Ø2)-W	OFF
	Y	Ø4 Y		DONT WALK	R (Ø2)-DW		
	←Y	Ø7 Y					
	←G	Ø7 G					

Figure 15.13
E-W Lead-Lag Phasing Example 2
North-South Main Line

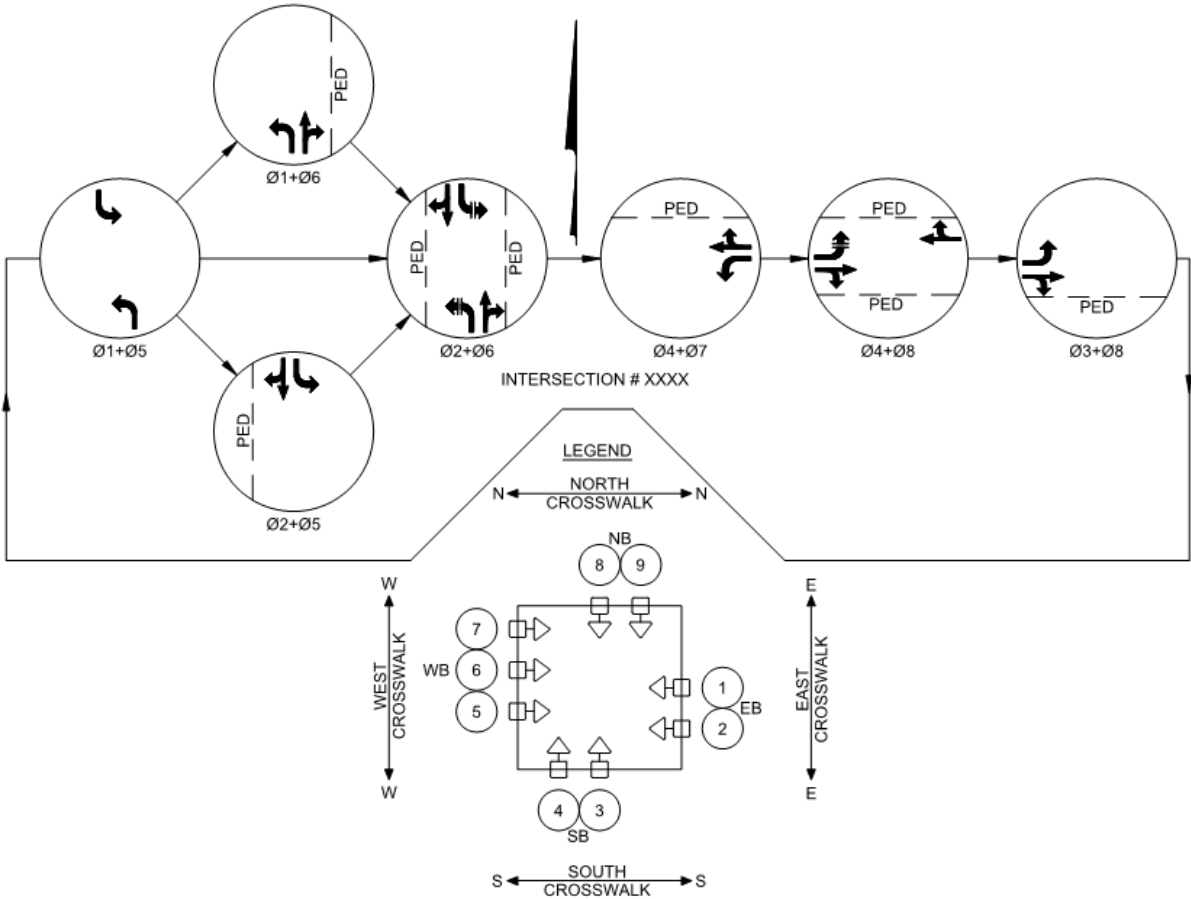

FIELD WIRING HOOK-UP CHART							
SIGNAL HEAD #	INDICATION	FIELD TERMINAL	FLASH	SIGNAL HEAD #	INDICATION	FIELD TERMINAL	FLASH
1 (EBLT)	R	Ø8 R	R	6,7 (WB)	R	Ø4 R	R
	Y	Ø8 Y			Y	Ø4 Y	
	G	Ø8 G			G	Ø4 G	
	←Y	Ø3 Y		8 (NBLT)	R	Ø6 R	R
	←G	Ø3 G			Y	Ø6 Y	
2 (EB)	R	Ø8 R	R	G	Ø6 G		
	Y	Ø8 Y	←Y	Ø1 Y			
	G	Ø8 G	←G	Ø1 G			
3 (SBLT)	R	Ø2 R	R	9 (NB)	R	Ø6 R	R
	Y	Ø2 Y		Y	Ø6 Y		
	G	Ø2 G		G	Ø6 G		
	←Y	Ø5 Y		N (NORTH)	WALK	G (Ø4)-W	OFF
	←G	Ø5 G		DONT WALK	R (Ø4)-DW		
4 (SB)	R	Ø2 R	R	E (EAST)	WALK	G (Ø6)-W	OFF
	Y	Ø2 Y	DONT WALK	R (Ø6)-DW			
	G	Ø2 G	S (SOUTH)	WALK	G (Ø8)-W	OFF	
5 (WBLT)	←R	Ø7 R	R	DONT WALK	R (Ø8)-DW		
	←Y	Ø7 Y		W (WEST)	WALK	G (Ø2)-W	OFF
	←G	Ø7 G		DONT WALK	R (Ø2)-DW		

Figure 15.14
Lead-Lag Phasing Example 3
North-South Main Line

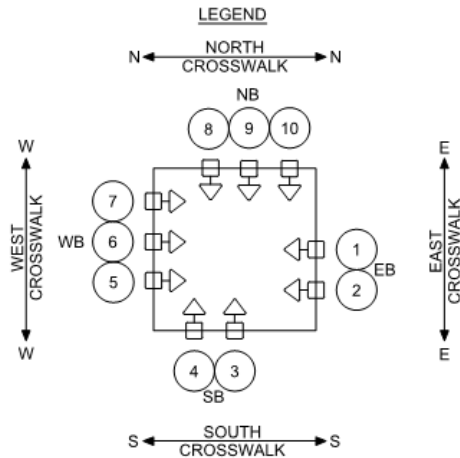
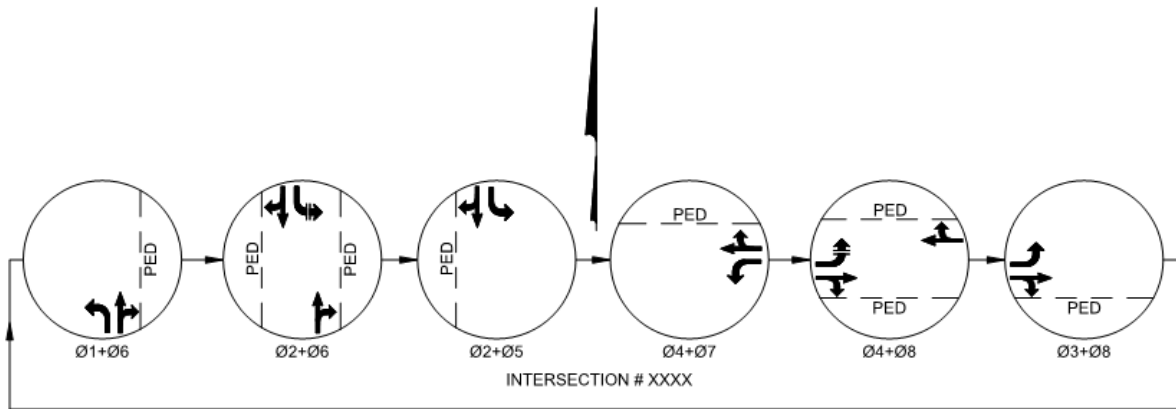

FIELD WIRING HOOK-UP CHART							
SIGNAL HEAD #	INDICATION	FIELD TERMINAL	FLASH	SIGNAL HEAD #	INDICATION	FIELD TERMINAL	FLASH
1 (EBLT)	R	Ø8 R	R	6,7 (WB)	R	Ø4 R	R
	Y	Ø8 Y			Y	Ø4 Y	
	G	Ø8 G			G	Ø4 G	
	←Y	Ø3 Y		←R	Ø1 R	8 (NBLT)	←Y
←G	Ø3 G	←G	Ø1 G				
2 (EB)	R	Ø8 R	R	9,10 (NB)	R	Ø6 R	R
	Y	Ø8 Y			Y	Ø6 Y	
	G	Ø8 G			G	Ø6 G	
3 (SBLT)	R	Ø2 R	R	N (NORTH)	WALK	G (Ø4)-W	OFF
	Y	Ø2 Y			DON'T WALK	R (Ø4)-DW	
	G	Ø2 G		E (EAST)	WALK	G (Ø6)-W	OFF
	←Y	Ø5 Y			DON'T WALK	R (Ø6)-DW	
4 (SB)	R	Ø2 R	R	S (SOUTH)	WALK	G (Ø8)-W	OFF
	Y	Ø2 Y			DON'T WALK	R (Ø8)-DW	
	G	Ø2 G		W (WEST)	WALK	G (Ø2)-W	OFF
←R	Ø7 R	DON'T WALK	R (Ø2)-DW				
5 (WBLT)	←Y	Ø7 Y	R				
	←G	Ø7 G					

Table 15.1
8 Phase Timing Chart
Major Street E-W, Minor Street N-S

MOVEMENT	EBLT	WB	NBLT	SB	WBLT	EB	SBLT	NB
PHASE	Ø1	Ø2	Ø3	Ø4	Ø5	Ø6	Ø7	Ø8
MIN INITIAL ¹	10	20	10	10	10	20	10	10
WALK ²	---	7	---	7	---	7	---	7
PED CHANGE ³	---	*	---	*	---	*	---	*
PASS / EXT ⁴	3.7	*	3.7	3.7	3.7	*	3.7	3.7
YELLOW ⁵	*	*	*	*	*	*	*	*
RED CLR ⁶	*	*	*	*	*	*	*	*
MAX GRN 1 ⁷	*	*	*	*	*	*	*	*
MAX GRN 2 ⁷	*	*	*	*	*	*	*	*
PED RECALL ⁸	OFF	ON	OFF	OFF	OFF	ON	OFF	OFF
VEH RECALL ⁸	OFF	MIN	OFF	OFF	OFF	MIN	OFF	OFF
MEMORY ⁸	OFF	ON	OFF	OFF	OFF	ON	OFF	OFF

All other settings are set to off or zero

* = calculate value

1 = See Section 15.1.6

2 = See Section 15.1.3

3 = See Section 15.1.5

4 = See Section 15.1.8

5 = See Section 15.1.1

6 = See Section 15.1.2

7 = See Section 15.1.7

8 = See Section 15.2.2

Table 15.2
8 Phase Timing Chart
Major Street N-S, Minor Street E-W

MOVEMENT	NBLT	SB	EBLT	WB	SBLT	NB	WBLT	EB
PHASE	Ø1	Ø2	Ø3	Ø4	Ø5	Ø6	Ø7	Ø8
MIN INITIAL ¹	10	20	10	10	10	20	10	10
WALK ²	---	7	---	7	---	7	---	7
PED CHANGE ³	---	*	---	*	---	*	---	*
PASS / EXT ⁴	3.7	*	3.7	3.7	3.7	*	3.7	3.7
YELLOW ⁵	*	*	*	*	*	*	*	*
RED CLR ⁶	*	*	*	*	*	*	*	*
MAX GRN 1 ⁷	*	*	*	*	*	*	*	*
MAX GRN 2 ⁷	*	*	*	*	*	*	*	*
PED RECALL ⁸	OFF	ON	OFF	OFF	OFF	ON	OFF	OFF
VEH RECALL ⁸	OFF	MIN	OFF	OFF	OFF	MIN	OFF	OFF
MEMORY ⁸	OFF	ON	OFF	OFF	OFF	ON	OFF	OFF

All other settings are set to off or zero

* = calculate value

1 = See Section 15.1.6

2 = See Section 15.1.3

3 = See Section 15.1.5

4 = See Section 15.1.8

5 = See Section 15.1.1

6 = See Section 15.1.2

7 = See Section 15.1.7

8 = See Section 15.2.2

CHAPTER 16: PEDESTRIAN HYBRID BEACONS (PHBs)

16.1 General

In addition to the standards specified in Section 4F of the [OMUTCD](#), the following considerations are applicable to the design and installation of PHBs.

The typical PHB design within the City of Columbus consists of one mast arm extending across all lanes of traffic with pedestrian pedestals as needed to provide locations for pedestrian signal heads and pedestrian pushbuttons.

16.2 PHB Support Placement

Supports and pedestals shall be provided and placed per the requirements in **Chapter 4**.

Where PHBs are installed at mid-block locations, PHB supports and pedestals (including the pushbutton) should be located at the downstream end of the crosswalk.

When feasible, the PHB support or pedestal should be located to accommodate the pedestrian pushbutton position in accordance with **Section 16.3**. Should other design considerations prevent the PHB support or pedestal from accommodating the pushbutton, a separate pedestal support shall be used to locate the pushbutton in an acceptable location.

16.3 Pedestrian Pushbuttons

Locations of pedestrian pushbuttons for PHBs shall be in accordance with the placement requirements outlined in the City of Columbus [ADA Rules and Regulations](#) and shall also be installed in accordance with the requirements in **Chapter 6**.

It is preferable for pedestrians to cross the entire street in one movement unless design constraints are such that a two-stage crossing is necessary. Where a two-stage crossing is used, pedestrian pushbuttons shall be provided in the median and located in accordance with City of Columbus [Design Memo 6.05: Pedestrian Islands](#).

16.4 Sight Distance

PHBs should be designed such that drivers have adequate stopping sight distance to see pedestrians waiting to cross. In locations with on-street parking, parking shall be prohibited within 30 feet of a crosswalk with PHBs (both upstream and downstream) as parking is prohibited within 30 feet of flashing beacons under [Columbus City Code Section 2151.01](#). Other sight obstructions

should be removed or limited within this area. If these conditions cannot be met, curb extensions or other techniques should be used to provide adequate sight distance. Curb extensions should be designed to prohibit parking for the distances specified in this section. For more information, see [City of Columbus Design Memo 6.04: Curb Extensions](#).

16.5 Signing

Pedestrian Crossing (W11-2), School (S1-1), or Bicycle/Pedestrian Crossing (W11-15) signs with diagonal downward arrow plaques (W16-7P) shall be provided at PHBs. This signage is typically installed on the signal support; however, it may also be installed using standard ground mounted sign supports. This signage shall be installed on both sides of the roadway. On two-way roadways, this signage shall be double-sided so that it is visible to both directions of travel on both sides of the roadway. A Pedestrian Crossing (W11-2), School (S1-1), or Bicycle/Pedestrian Crossing (W11-15) sign may also be installed in advance of a PHB with an AHEAD plaque (W16-9P).

A CROSSWALK, STOP ON RED, PROCEED ON FLASHING RED WHEN CLEAR (R10-23a) sign shall be mounted overhead on the PHB mast arm for each major street approach. The sign shall be centered between signal heads.

Pushbuttons installed at PHBs shall be accompanied by a PUSH BUTTON TO CROSS STREET WAIT FOR WALK (R10-3a) sign. This sign shall be installed in accordance with [City of Columbus Standard Construction Drawing 4230](#).

Signs used at PHBs are shown in **Figure 16.1**.

Figure 16.1
PHB Signs

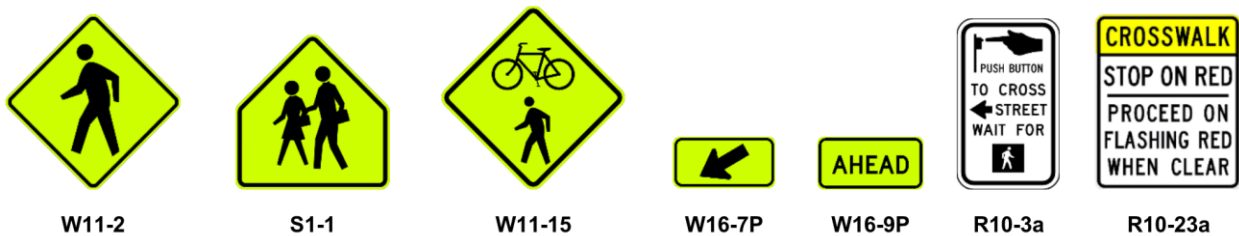

16.6 Pavement Markings

Stop lines shall be provided on each approach to the crosswalk. Locate stop lines in accordance with [OMUTCD](#) Section 4D.14. When a PHB is installed at an intersection, the stop line shall be installed across all lanes, including turn lanes, for the approach nearest the crosswalk that is controlled by the PHB. For the approach on the side of the intersection farthest from the PHB-controlled crosswalk, the stop line shall only be installed across the through lanes. Stop lines shall not be installed across far side turn lanes since those movements do not conflict with pedestrians in the PHB-controlled crosswalk. See City of Columbus [Design Memo 9.05: Stop Line Placement](#) for guidance on stop line marking placement on the intersecting side street.

Crosswalks controlled by a PHB shall have high-visibility Type II crosswalk markings. See City of Columbus [Design Memo 6.41: Crosswalks](#) for additional information on crosswalk markings.

16.7 Signal Phase Assignments

Phases shall be assigned using the following standard City of Columbus phasing:

- Vehicle movement shall be assigned to Ø2 and Ø6
- Pedestrian movement shall be assigned to Ø4

Figure 16.2 and **Figure 16.3** depict example PHB phasing and field wiring hook-up charts for east-west and north-south mainlines, respectively.

Figure 16.2
PHB Phasing and Field Wiring Hook-up Chart Example
East-West Mainline

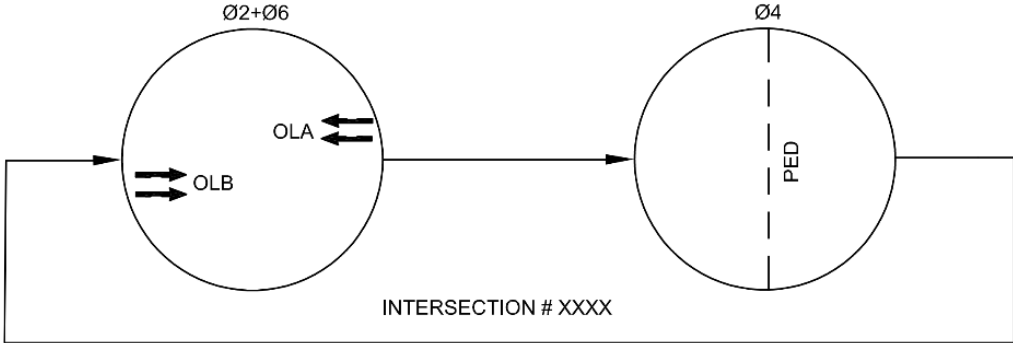

LEGEND

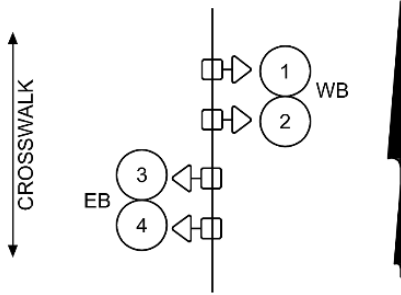

FIELD WIRING HOOK-UP CHART			
SIGNAL HEAD #	INDICATION	FIELD TERMINAL	FLASH
1, 2 (WB)	R (LEFT)	Ø2 R	Y
	R (RIGHT)	OLA R	
	Y	Ø2 Y	
3, 4 (EB)	R (LEFT)	Ø6 R	Y
	R (RIGHT)	OLB R	
	Y	Ø6 Y	
PED	WALK	G (Ø4)-W	OFF
	DON'T WALK	R (Ø4)-DW	
OLA = Ø2 OLA = LS9 OLB = Ø6 OLB = LS10			

Figure 16.3
PHB Phasing and Field Wiring Hook-up Chart Example
North-South Mainline

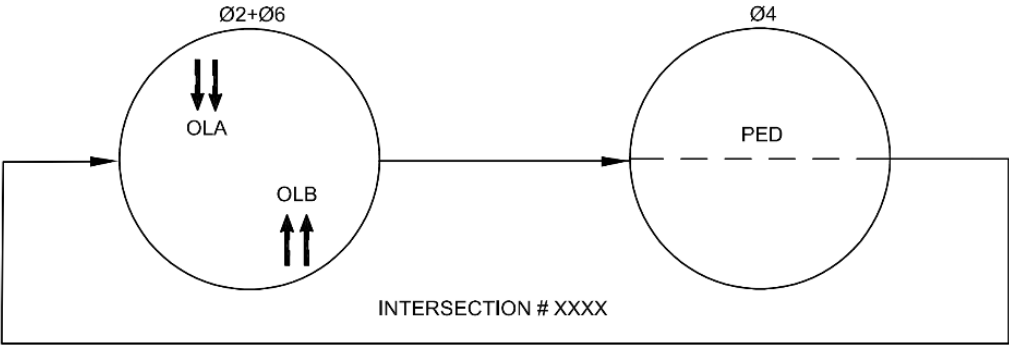

LEGEND

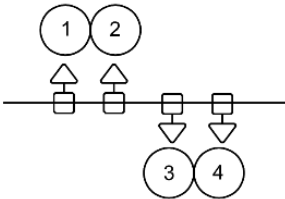
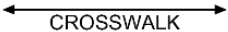

FIELD WIRING HOOK-UP CHART			
SIGNAL HEAD #	INDICATION	FIELD TERMINAL	FLASH
1, 2 (SB)	R (LEFT)	Ø2 R	Y
	R (RIGHT)	OLA R	
	Y	Ø2 Y	
3, 4 (NB)	R (LEFT)	Ø6 R	Y
	R (RIGHT)	OLB R	
	Y	Ø6 Y	
PED	WALK	G (Ø4)-W	OFF
	DONT WALK	R (Ø4)-DW	
OLA = Ø2 OLA = LS9 OLB = Ø6 OLB = LS10			

16.8 Sequencing and Timing

The standard sequence for PHB and pedestrian signal head indications shall be as described below and as shown in **Figure 16.4**. An example timing chart is provided in **Table 16.1**.

Figure 16.4
Sequence for a Pedestrian Hybrid Beacon

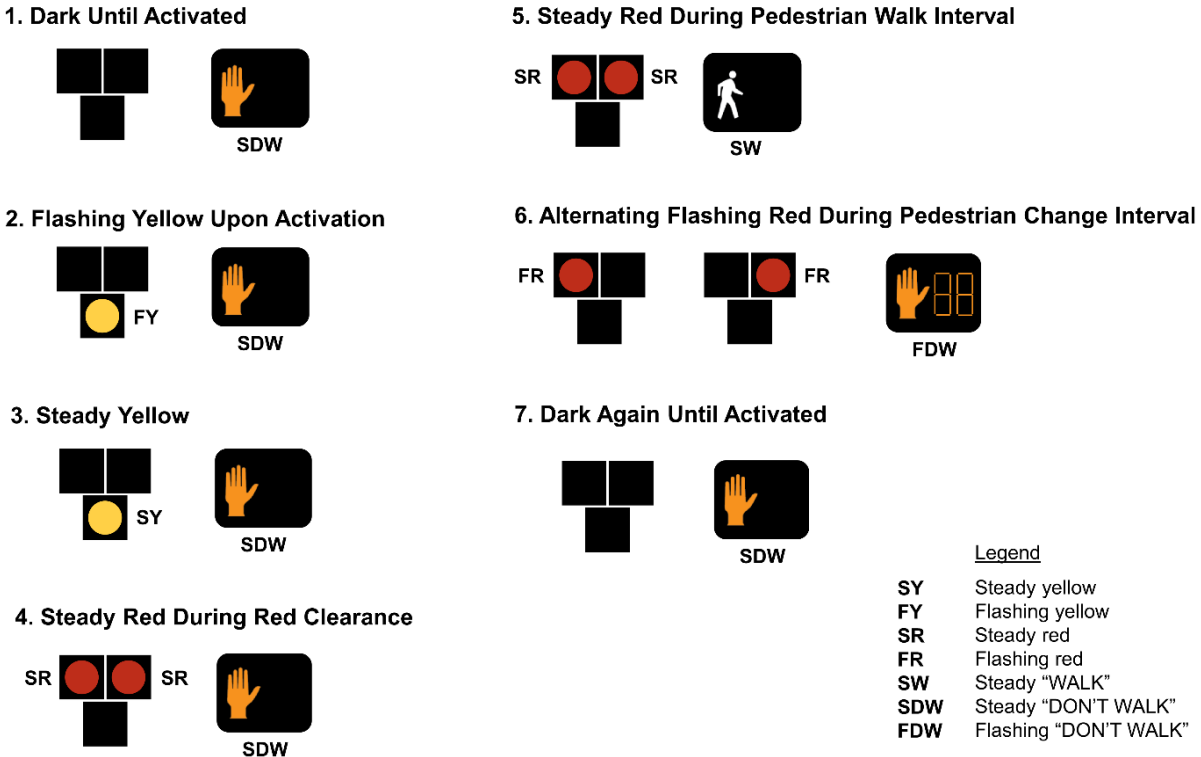

Sequence 1 – Beacon Dark/Steady DON'T WALK

Minimum dark time for Ø2 and Ø6 shall be 10 seconds.

Sequence 2 – Flashing Yellow Interval/Steady DON'T WALK

Upon Activation. The flashing yellow interval for Ø2 and Ø6 should be determined by engineering judgment and shall be between 3 and 5 seconds.

Sequence 3 – Steady Yellow Change Interval/Steady DON'T WALK

The steady yellow change interval for Ø2 and Ø6 shall be calculated per the Yellow Clearance Interval requirements in **Section 15.1.1**. Per [OMUTCD](#) Section 4F.03, the steady yellow interval should have a minimum duration of 3 seconds and a maximum duration of 6 seconds.

Sequence 4 – Red Clearance Interval (All Red)/Steady DON'T WALK

The red clearance interval for Ø2 and Ø6 shall be 1 second minimum. If the PHB is located at an intersection, the red clearance interval shall be calculated per the Red Clearance Interval requirements in **Section 15.1.2**. If the PHB is located at a mid-block location, the red clearance interval shall be calculated using the same Red Clearance Interval requirements, using the distance from the stop line to the far side of the crosswalk as the width of intersection.

Sequence 5 – Steady Red/Pedestrian Walk Interval

The steady red/pedestrian walk interval (Ø4 pedestrian walk interval) shall be calculated per the Pedestrian Walk Time requirements in **Section 15.1.3**.

Sequence 6 – Alternating Flashing Red/Flashing DON'T WALK

The flashing red/flashing DON'T WALK interval (Ø4 pedestrian change interval) shall be sufficient to allow a pedestrian crossing in the crosswalk who left the curb or shoulder at the end of the WALKING PERSON (symbolizing WALK) signal indication to travel at a walking speed of 3.5 feet per second to the far side detectable warning or to a median of sufficient width for pedestrians to wait if a two-stage crossing is used.

$$\text{Ped Change Interval} = \text{Ped Clearance Interval} = \frac{\text{Crossing Distance}}{\text{Walking Speed}}$$

Additionally, the total of the pedestrian walk interval (Sequence 5) and the pedestrian change interval (Sequence 6) shall be sufficient to allow a pedestrian crossing in the crosswalk who left the pedestrian detector at the beginning of the WALKING PERSON (symbolizing WALK) signal indication to travel at a walking speed of 3 feet per second to the far side detectable warning or to the median if a two-stage crossing is used. Any additional time that is required to satisfy the conditions of this paragraph should be added to the pedestrian walk interval (Sequence 5).

Return/Rest

After Sequence 6, the PHB shall return/rest in Sequence 1.

Table 16.1
PHB Timing Chart Example

MOVEMENT	WB	EB	CROSSWALK
PHASE	Ø2	Ø6	Ø4
BEACONS DARK (MIN GREEN) ¹	10	10	-
FLASHING YELLOW (PED CHG) ²	3.0	3.0	-
STEADY YELLOW (YELLOW) ³	*	*	-
RED CLR (RED) ⁴	*	*	-
STEADY RED (WALK) ⁵	-	-	*
FLASHING RED (PED CHG) ⁶	-	-	*

Terms in parentheses are each movement's associated controller parameter.

All other settings are set to off or zero

* = calculate value

1 = See *Sequence 1* above

2 = See *Sequence 2* above

3 = See *Sequence 3* above

4 = See *Sequence 4* above

5 = See *Sequence 5* above

6 = See *Sequence 6* above

16.9 Supports and Foundations

PHB supports and foundations shall be furnished in accordance with Sections 632 and 732 of the current versions of the [City of Columbus Construction and Material Specifications](#) and applicable [Standard Construction Drawings](#).

Supports for PHB assemblies shall also be in accordance with the City of Columbus Traffic Qualified Products List.

Approved PHB support types include the following:

- Standard Mast Arm Support – Standard mast arm supports are used to provide an overhead mounting location for PHB signal heads ([City of Columbus Standard Construction Drawing 4120](#))
- Decorative Mast Arm Support – Decorative mast arm supports are used to provide an overhead mounting location for PHB signal heads in the Downtown District ([City of Columbus Standard Construction Drawing 4121](#)).

Mast arms shall be sized such that it extends 2 feet beyond the last proposed attachment point of the beacon display.

16.10 Vehicular Signal Heads

PHB signal heads shall feature 12-inch diameter lenses. Signal heads shall feature louvered aluminum backplates as per [City of Columbus Standard Construction Drawing 4205](#). Signal heads with backplates shall be rigidly mounted to the mast arm. Primary PHB signal heads shall be mounted overhead. Auxiliary/supplemental PHB signal heads may be side-mounted if necessary.

PHB head alignment scenarios are shown in **Figure 16.5** and **Figure 16.6**.

Figure 16.5
Pedestrian Hybrid Beacon Head Alignment
Mid-Block Crossing
Two Approach Lanes

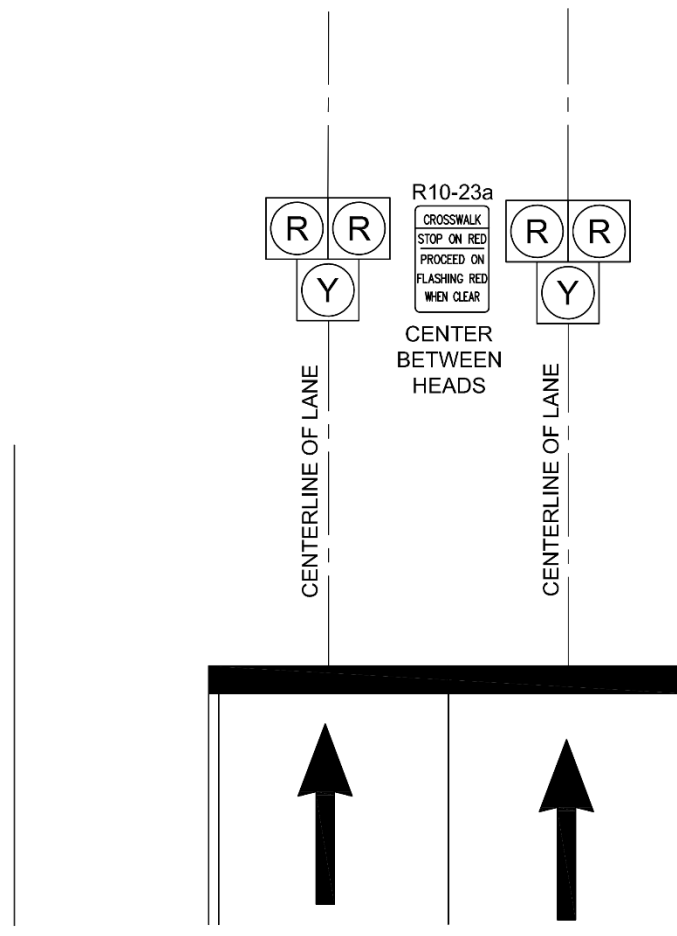
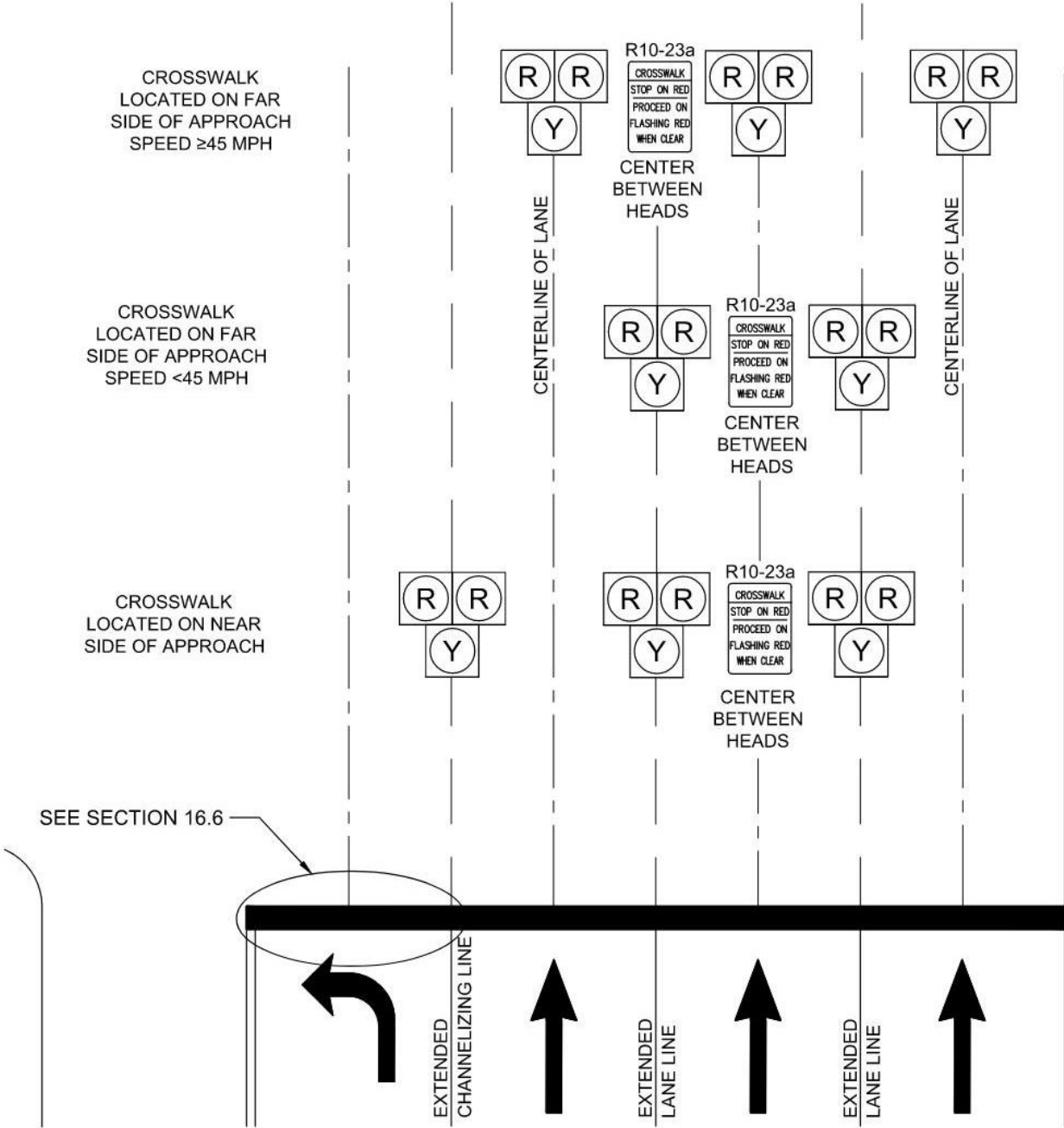

Figure 16.6
Pedestrian Hybrid Beacon Head Alignment
Intersection Crossing
Four Approach Lanes



16.11 Wiring

Wiring standards shall be per the requirements in **Chapter 7**. PHBs shall be grounded and bonded per the requirements of **Chapter 7**. PHB signal heads shall use 7/C minimum #14 AWG signal cable.

See **Figure 16.7** for a sample PHB wiring diagram.

Figure 16.7
Pedestrian Hybrid Beacon Wiring Diagram Example

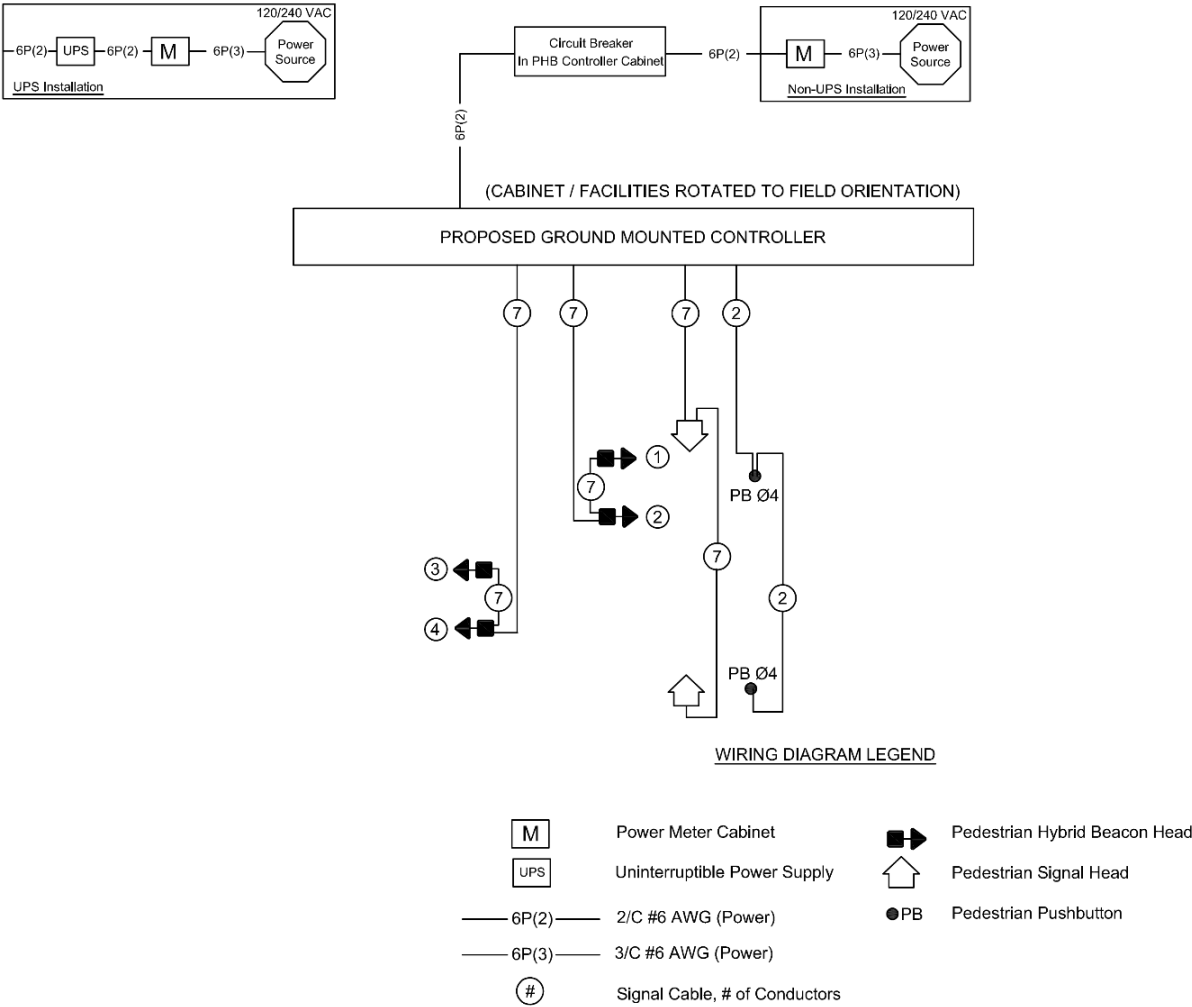

16.12 Controller and Power Meter Cabinets

PHBs shall use standard TS-2, 8-phase, 16-channel, size 6 cabinets. Power meter cabinets shall also be provided.

16.13 Interconnect

PHBs shall be connected to the City of Columbus Traffic Signal System (CTSS) per the requirements in **Chapter 12**.

CHAPTER 17: SPECIAL CONDITIONS

17.1 Emergency Vehicle Preemption

Emergency vehicle preemption standards are under development by the City of Columbus, Department of Public Service. Additional information will be published when available.

Emergency vehicle preemption shall only be specified when directed by the City of Columbus, Department of Public Service. When used, detailed specifications should be obtained from the City.

17.2 Railroad Preemption

Prequalification through the Ohio Department of Transportation's Traffic Academy for Traffic Signal and Railroad Preempted Traffic Signal Training is required to design new or modified railroad preempted traffic signals.

Railroad preemption shall be as specified in the Ohio Department of Transportation's Traffic Engineering Manual, Chapter 4 (Traffic Signals) and Chapter 8 (Rail Grade Crossings).

17.3 Transit Priority

Transit priority standards are under development through the combined efforts of the City of Columbus and the Central Ohio Transit Authority (COTA).

Transit priority shall only be specified when directed by the City of Columbus, Department of Public Service. When used, detailed specifications should be obtained from the City.

17.4 Leading Pedestrian Interval (LPI)

LPI is a pedestrian-vehicle conflict countermeasure for signalized intersections. LPI is also known as "pedestrian head start" or "delayed vehicle green" that gives pedestrians an advance walk signal indication before a concurrent vehicular green signal is provided. This allows pedestrians to establish a presence in the crosswalk, thereby increasing their visibility to drivers and potentially reducing conflicts with turning vehicles.

17.4.1 Criteria

LPI consideration should only be given to individual crosswalks, not necessarily all crosswalks at an intersection, which meet at least one of the following criteria at a signalized intersection:

- **Pedestrian Crashes:** Intersections with a crash history or documented near misses between vehicles turning on green and pedestrians crossing the street in a crosswalk in the same direction as vehicle travel should be evaluated for an LPI. A minimum of three pedestrian crashes or near misses must be documented at an intersection over a 5-year period to be considered for an LPI.
- **Land-use Characteristics:** At a signalized intersection near sources of high pedestrian volumes. These land uses include but are not limited to schools, parks, hospitals, trail crossings, and other places with high volumes of children, elderly, or handicapped pedestrians.
- **Intersection Demand:** Locations where both pedestrian and turning vehicle volumes are high.
- **Intersection Geometry and/or Visibility Constraints:** At signalized intersections where geometry and/or visibility constraints are a concern. These constraints may include but are not limited to:
 - Sun angle that impedes visibility at certain times of the day or times of the year
 - Nighttime visibility issues that cannot be adequately addressed through street lighting improvements
 - Intersection geometry that obscures pedestrians from motorists or vice versa
 - Signalized intersections with two or more lanes that turn over a crosswalk
 - T-intersections
 - Intersections with one-way streets
- **Engineering Judgement:** An LPI may be implemented at the direction of the Administrator of the Division of Traffic Management or designee.

17.4.2 Implementation

An LPI shall not be used in conjunction with protected/permmissive left-turn phasing adjacent to or crossing the desired LPI crosswalk due to possible pedestrian-vehicle conflicts. Any questions regarding the feasibility of implementing an LPI phase(s) shall be directed to Division of Traffic Management – Signal Operations staff.

The following are the acceptable LPI implementation scenarios:

- LPI phase(s) where both corresponding vehicular approaches have permissive movements only (no protected/permmissive lefts, no protected only lefts). The LPI shall begin prior to permissive only movements which cross over the crosswalk. This requires delayed green for the opposing vehicular phase. The LPI will need to be implemented with the opposing pedestrian phase (if present) as well as through controller programming.
- LPI phase(s) where the opposing vehicular approach has protected only left-turn movements crossing the subject crosswalk. The LPI shall be implemented with the phase associated with the adjacent through/right movements, but prior to the green interval for through/right movements.
- LPI phase(s) where split phase operation is present: The LPI shall be implemented with the adjacent through/right movements where the crosswalk is on the right side of the driver.
- For crosswalks where LPI is implemented and the signal does not operate under pre-timed control, the pedestrian phase shall be pushbutton-activated and the signal controller setting for Pedestrian Recall shall be set to “OFF.”

LPI timing should allow pedestrians from the location of the pushbutton to clear at least the width of one lane of vehicular traffic. This shall be in addition to the width of a parking and/or bicycle lane, if present. In the case of a large corner radius, the LPI time should allow the pedestrian to travel far enough into the crosswalk to establish their position ahead of the turning traffic before the turning traffic is provided a green indication. The LPI time shall be set for a minimum of 3 seconds and a maximum of 7 seconds.

Leading Pedestrian Interval Timing Equation

$$\text{LPI Time} = \frac{\text{Distance from pushbutton to far side of nearest travel lane}}{\text{Walking Speed}}$$

17.4.3 Additional Considerations

When an LPI is used, consideration may be given to implementing the following additional treatments:

- NO TURN ON RED sign (R10-11b)
- An LED blank-out sign may be considered instead of a static NO TURN ON RED sign to display either the No Right Turn symbol (OMUTCD sign R3-1) or word message when the LPI is activated. Use of LED blank-out signs shall be approved by the City of Columbus, City Engineer or appointed designee.
- Accessible Pedestrian Signal (APS). See **Section 6.3**.

17.5 General Flashing Operation

For most traffic signal flashing operations, the main street should display flashing yellow indications and the side street should display flashing red indications.

Flashing red for all directions shall be considered under the following conditions:

- When the main street and side street volumes are approximately equal.
- When 6 or more phases are used.
- When intersection sight distance for the side street is less than specified in the [Ohio Department of Transportation's Location and design Manual Volume 1](#).
- Where a protected only left turn phase is used.
- Where "No Turn On Red" signs are used.
- Where the signal was warranted by crashes.

Flashing operations for Protected/Permissive and Protected Only Left Turn Movements:

- Vehicular signal heads for Protected/Permissive movements (5 section heads) shall display a flashing circular yellow or circular red consistent with the flashing display for that approach.
- Left Turn Protected Only movements on the major street:
 - If the protected only movement is due to signal sequencing such as a lagging or lead-lag Left Turn phase, a flashing yellow arrow may be used as long as the main line also flashes circular yellow.
 - If the protected only movement is necessary due to intersection geometry or sight distance restrictions, all signal heads shall flash red.
 - All flashing operations shall conform to the requirements of Section 4D.30 of the [Ohio Manual of Uniform Traffic Control Devices](#).
- Left Turn Protected Only movements on side streets shall flash red.
- When an intersection flashes all red (programmed or conflict), each Protected Left Turn head shall also flash red.

17.5.1 New Signal Flashing Operations

New traffic signals shall be flashed in accordance with the [City of Columbus Construction and Material Specifications](#) Section 632.056.

17.5.2 Programmed (Night) Flashing Operations

Programmed flashing operation shall occur through a schedule routine by either a time clock or system command.

To change between regular signal operation and flashing operation the following processes shall be implemented:

- Standard Operation to Flash Operation
When the flash command is received, a vehicle call shall be placed on all phases and the side street movements shall be serviced. The change to flashing operation shall be made at the end of the major street red interval; just prior to beginning a major street green interval - either a through phase or a left turn phase.

- Flash Operation to Standard Operation
The signal should return to regular operation in the predetermined initialization routine (e.g.; major street green interval following a flashing yellow operation; side street red interval following a flashing red operation).

17.5.3 School Signal Flashing Operations

When a traffic signal is warranted based on Warrant 5 (school crossing) in Part 4 of the [Ohio Manual of Uniform Traffic Control Devices](#), and will operate on flash when not warranted, the following items shall be considered:

- 12 in. signal heads shall be used.
- An all red interval shall be used after the mainline yellow interval. This interval shall be calculated based on the procedures outlined in **Chapter 15** and must be a minimum of 1.5 seconds.
- The side street shall be actuated.
- City of Columbus sign “School Signal” (CW-302-24) should be placed between the signal heads.
- The signal should revert to flashing operation when traffic volumes/pedestrian volumes do not meet warrant thresholds. When signals are closely spaced, the effect of the flashing operation and visibility to drivers at adjacent intersections should be investigated to identify any potential adverse effects for through motorist.
- The following shall be considered when determining the flash/non-flash hours of operation.
 - Nature of the pedestrian traffic (age, volume, mobility impaired) and vehicular traffic (volume, classification).
 - Pedestrian needs other than major crossing period. (Playground use, after hours school/recreation center activities).
 - Safety history of intersection.
 - Vehicular speeds.
 - Available gaps during non-school crossing periods.

17.6 Non DPS Pole Attachment Process

Attachment of traffic signal cable to another agency's pole requires approval from the pole owner. Applicable attachment permits shall be secured and furnished to the City of Columbus.

As part of securing a permit, the utility pole owner must be identified. The list of pole owners furnished in **Section 1.3**, only represent some of the owners that maintain poles in the Columbus area. There are other pole owners.

Cable attachment to AEP owned utility poles requires coordination with the City of Columbus Utility Coordinator and Project Manager to gain access to the aerial utility data base or completion of a pole attachment agreement form. A sample work sheet is illustrated in **Figure 17.1**.

Cable attachment to City of Columbus, Division of Power owned utility poles required completion of a pole attachment agreement work sheet. A sample work sheet is illustrated in **Figure 17.2**.

17.7 Proposed Signal with Unresolved Warrant Status

When a new traffic signal is proposed based on projected traffic volumes generated by future development, the signal warrant status may not be fully determined until after the design is complete and the project is under construction. Under these conditions, the City of Columbus shall reevaluate the warrant status just prior to the installation of signal infrastructure. The warrant status upon the conclusion of this evaluation shall determine if the above-ground items will be installed with the project. If the City determines that the signal is not yet warranted, only the underground portions of the signal shall be installed. Capped conduit with tracing wire shall be installed to the center of the planned pedestrian pedestal or signal support structure. All other elements of the traffic signal shall be delivered to the traffic maintenance shop for storage.

Under this condition, the designer shall note in the Traffic Signal Estimate of Quantities any work that shall not be performed until the warrant status is resolved and as directed by the City. An example is provided in **Figure 17.3**. The designer shall also include a standard plan note, as provided by the City of Columbus, on the signal plan view sheet.

FIGURE 17.3
Indicating Warrant Status in Quantities

Street A at Street B	ITEM NO.	ESTIMATED QUANTITY	UNIT	DESCRIPTION
				TRAFFIC SIGNAL
223	625	243	LF	Conduit, Concrete Encased, 2", 725.051
133	625	292	LF	Conduit, Concrete Encased, 3", 725.051
248	625	667	LF	Conduit, 2", 725.051
364	625	728	LF	Trench, As Per Plan
2	625	3	Each	Pull Box, 27", As Per Plan
2	625	5	Each	Pull Box, 32", As Per Plan
1	625	3	Each	Pull Box, 48", Type 1, As Per Plan
3	625	3	Each	Pull Box, 725.06, 12" x 18" (Traffic)
10(W)	625	21	Each	Ground Rod
341(W)	625	614	LF	No. 4 AWG, 600 Volt Distribution Cable, As Per Plan
1(W)	630	2	Lump	Signaling, Misc.: Traffic Signal Signs
4(W)	630	8	Each	Sign Support Assembly, Pole Mounted, As Per Plan
1(W)	632	1	Each	Conduit Riser, 2", SCH 80 (Gray), 725.053
6(W)	632	12	Each	Vehicular Signal Head, L.E.D., 3-Section, 12" Lens, 1-Way, Polycarbonate, As Per Plan
2(W)	632	6	Each	Vehicular Signal Head, L.E.D., 5-Section, 12" Lens, 1-Way, Polycarbonate, As Per Plan
8(W)	632	16	Each	Pedestrian Signal Head
4(W)	632	8	Each	Pedestrian Pushbutton

(W) = Install only if signal is determined to be warranted. See warrant status note on sheet _____. (signal plan view sheet)