

Columbus City Bulletin



Bulletin #8
February 19, 2011

Proceedings of City Council

Saturday February 19, 2011



SIGNING OF LEGISLATION

(Legislation was signed by Council President Andrew J. Ginther on the night of the Council meeting, Monday, *February 14, 2011*; by Mayor, Michael B. Coleman on *Tuesday, February 15, 2011*; and attested by the City Clerk, prior to Bulletin publishing.)

The City Bulletin **Official Publication of the City of Columbus**

Published weekly under authority of the City Charter and direction of the City Clerk. The Office of Publication is the City Clerk's Office, 90 W. Broad Street, Columbus, Ohio 43215, 614-645-7380. The City Bulletin contains the official report of the proceedings of Council. The Bulletin also contains all ordinances and resolutions acted upon by council, civil service notices and announcements of examinations, advertisements for bids and requests for professional services, public notices; and details pertaining to official actions of all city departments. If noted within ordinance text, supplemental and support documents are available upon request to the City Clerk's Office.

Council Journal (minutes)



City of Columbus

Journal - Final

Columbus City Council

Office of City Clerk
90 West Broad Street
Columbus OH
43215-9015
columbuscitycouncil.org

ELECTRONIC READING OF MEETING DOCUMENTS AVAILABLE DURING COUNCIL OFFICE HOURS. CLOSED CAPTIONING IS AVAILABLE IN COUNCIL CHAMBERS. ANY OTHER SPECIAL NEEDS REQUESTS SHOULD BE DIRECTED TO THE CITY CLERK'S OFFICE AT 645-7380 BY FRIDAY PRIOR TO THE COUNCIL MEETING.

Monday, February 14, 2011

5:00 PM

Columbus City Council

Columbus City Council

Journal

February 14, 2011

**REGULAR MEETING NO. 8 OF COLUMBUS CITY COUNCIL, FEBRUARY 14, 2011
at 5:00 P.M. IN COUNCIL CHAMBERS.**

ROLL CALL

Absent: 1 - Tyson

Present: 6 - President Pro-Tem Craig, Klein, Miller, Mills, Paley and
President Ginther

READING AND DISPOSAL OF THE JOURNAL

A motion was made by President Pro-Tem Craig, seconded by Klein, to Dispense with the reading of the Journal and Approve. The motion carried by the following vote:

Absent: 1 - Tyson

Affirmative: 6 - President Pro-Tem Craig, Klein, Miller, Mills, Paley and
President Ginther

C0004-2011

THE CITY CLERK'S OFFICE RECEIVED THE FOLLOWING
COMMUNICATIONS AS OF WEDNESDAY FEBRUARY 9, 2011.

Transfer Type: D1, D3

To: Jason Fetter

1st Fl & Bsmt

1602 S Fourth St

Columbus OH 43207

Permit # 2700304

New Type: D3A

To: Keyarrow LLC

1884 Tamarack Circle S & Patio

Columbus OH 43229

Permit # 4616208

Transfer Type: D5, D6

To: Regal Distributing Company Inc

Craze Mule Saloon & Patio

6188 Cleveland Av

Columbus OH 43231
From: NZS Holdings LLC
6188 Cleveland Av & Patio
Columbus OH 43231
Permit # 72682390005

Transfer Type: C1, C2, D6
To: Frebis Beer Dock Inc
DBA Beer Dock South
414 Frebis Av
Columbus OH 43206
From: 414 Frebis Inc
DBA Beer Dock South
414 Frebis Av
Columbus OH 43206
Permit # 2899192

Transfer Type: D5A, D6
To: Hotel Investments I LLC
DBA Ramada Plaza Columbus
Bldg A B C & Patios
4900 Sinclair Rd
Columbus OH 43229
From: Remar LLC
4900 Sinclair Rd Bldg A B C & Patios
Columbus OH 43229
Permit # 3997875

Transfer Type: D1
To: Barrel and Bottle LLC
59 Spruce St #136
Columbus OH 43215
From: Platinum Restaurant Group Inc
DBA Eddie Merlots
1570 Polaris Parkway & Patio
Columbus OH 43240
Permit # 04712070005

Transfer Type: D1, S3, D3A, D6
To: Minga Inc
DBA Minga Restaurant
800 Bethel Rd
Columbus OH 43214
From: Chang Family Inc
DBA Min Ga Korean Restaurant
800 Bethel Rd
Columbus OH 43214
Permit # 6030062

Transfer Type: D1, D2, D3, D3A, D6
To: Balcon Inc
2096 W Henderson Rd

Columbus OH 43220
 From: Balcon Inc
 1st Fl Ste H
 2280 W Henderson Rd & Patio
 Columbus OH 43220
 Permit # 04002440001

Advertise: 02/19/2011

Return: 03/01/2011

Read and Filed

RESOLUTIONS OF EXPRESSION

PALEY

0019X-2011

To honor the National Council of Jewish Women, Columbus Section, for their tireless efforts in helping reduce teen dating abuse and to recognize February as National Teen Dating Violence Prevention and Awareness Month.

Sponsors: Eileen Y. Paley, Hearcel Craig, Zachary M. Klein, A. Troy Miller, Michelle M. Mills, Priscilla Tyson and Andrew Ginther

A motion was made by Paley, seconded by President Pro-Tem Craig, that this matter be Adopted. The motion carried by the following vote:

Absent: 1 - Tyson

Affirmative: 6 - President Pro-Tem Craig, Klein, Miller, Mills, Paley and President Ginther

FIRST READING OF 30-DAY LEGISLATION

A MOTION WAS MADE BY COUNCILMEMBER MILLER, SECONDED BY COUNCILMEMBER MILLS TO WAIVE THE READING OF THE TITLES OF FIRST READING LEGISLATION. THE MOTION CARRIED THE FOLLOWING VOTE:

AFFIRMATIVE: 6 NEGATIVE: 0

FINANCE: TYSON, CHR. MILLER PALEY GINTHER

0175-2011 FR To authorize the Director of Finance and Management to establish a purchase order for the expenditure of \$930,000.00 from the Property Management Fund for payments to Paradigm Properties of Ohio, LLC for the fourth year of a Facilities Management Agreement for the Jerry Hammond Center. (\$930,000.00)

Read for the First Time

DEVELOPMENT: KLEIN, CHR. MILLER TYSON GINTHER

0202-2011 FR To authorize the Director of the Department of Development to enter into a grant agreement with Methodist ElderCare Services in order to foster sustainable building through LEED certification of the Wesley Glen Wellness Center, 5155 N. High St., pursuant to the Green Columbus Fund Program; and to authorize the expenditure of up to \$15,840.00 from the Northland and Other Acquisitions Fund. (\$15,840.00)

Read for the First Time

0203-2011 FR To authorize the Director of the Department of Development to enter into a

grant agreement with Heart of Ohio Family Health Centers in order to foster sustainable building through LEED certification of the replacement of the Capital Park Family Health Center, 2635 Innis Road, pursuant to the Green Columbus Fund Program; and to authorize the expenditure of up to \$15,840.00 from the Northland and Other Acquisitions Fund. (\$15,840.00)

Read for the First Time

- 0204-2011 FR To authorize the Director of the Department of Development to enter into a grant agreement with Franklinton Development Association for Brownfield assessment and redevelopment of the Iron Horse Yard site located at 421-435 West State Street, pursuant to the Green Columbus Fund Program; and to authorize the expenditure of up to \$150,000.00 from the Northland and Other Acquisitions Fund. (\$150,000.00)

Read for the First Time

- 0205-2011 FR To authorize the Director of the Department of Development to enter into a grant agreement with U & I Properties, LLC for Brownfield assessment and redevelopment of the site located 154-164 Yale Ave., pursuant to the Green Columbus Fund Program; and to authorize the expenditure of up to \$54,000 from the Northland and Other Acquisitions Fund. (\$54,000)

Read for the First Time

- 0211-2011 FR To adopt the Trabue-Roberts Area Plan as a guide for development, redevelopment, and planning of future public improvements.

Read for the First Time

ADMINISTRATION: MILLER, CHR. PALEY TYSON GINTHER

- 0119-2011 FR To authorize the Director of the Department of Technology, on behalf of the Department of Public Safety, to renew an annual software maintenance and support agreement with MCM Technology LLC for the CommSHOP 360 Solution software application in accordance with the sole source procurement provisions of the Columbus City Codes; and to authorize the expenditure of \$20,007.44 from the Department of Technology internal service fund. (\$20,007.44)

Read for the First Time

- 0126-2011 FR To authorize the Director of the Department of Technology, on behalf of the Columbus Police Division, to renew an annual software maintenance and support agreement with Core Technology Corporation for the MultiBridge and CTCBridge software applications in accordance with the sole source procurement provisions of the Columbus City Codes; and to authorize the expenditure of \$18,671.00 from the Department of Technology, internal service fund. (\$18,671.00)

Read for the First Time

PUBLIC SERVICE & TRANSPORTATION: PALEY, CHR. CRAIG MILLER GINTHER

- 0216-2011 FR To authorize the Director of Public Service to enter into an agreement with the Director of the Ohio Department of Transportation and to grant consent and propose cooperation with the State of Ohio for this I-70 noise wall project for the Division of Design and Construction.(\$0.00)

Read for the First Time

PUBLIC UTILITIES: PALEY, CHR. CRAIG KLEIN GINTHER

- 0060-2011** FR To authorize the Director of Public Utilities to execute a construction contract with Deer Creek Excavating, LLC; to provide for payment of inspection, material testing and related services to the Transportation Division for the Safford/Union Area Stormwater System and Water Line Improvements Projects, for the Divisions of Sewerage and Drainage & Power and Water; to authorize the expenditure of \$629,262.00 from the Storm Sewer Bonds Fund; to authorize the expenditure of \$360,313.00 from the Storm Build America Bonds Fund; to authorize the transfer and expenditure of \$686,982.00 within the Water Build America Bonds Fund; and to authorize an amendment to the 2010 Capital Improvements Budget. (\$1,676,557.00)
Read for the First Time
- 0124-2011** FR To authorize the Director of Finance and Management to establish Blanket Purchase Orders for Liquid Chlorine, Powdered Activated Carbon, Zinc Orthophosphate, Carbon Dioxide, Aluminum Sulfate, Quicklime, Potassium Permanganate, and Soda Ash from established Universal Term Contracts with Univar USA, MeadWestvaco, Shannon Chemical, Pain Enterprises, United States Aluminate, Carmeuse Lime & Stone, Bonded Chemicals, and Bonded Chemicals for the Division of Power and Water, and to authorize the expenditure of \$13,466,000.00 from Water Systems Operating Fund. (\$13,466,000.00)
Read for the First Time

CONSENT ACTIONS

FINANCE: TYSON, CHR. MILLER PALEY GINTHER

- 0133-2011** CA To authorize the Finance and Management Director to renew a contract for the Facilities Management Division with Pad Door Systems for the maintenance and repair of entrance doors and overhead doors; and to authorize the expenditure of \$30,000.00 from the General Fund. (\$30,000.00)
This Matter was Approved on the Consent Agenda.
- 0151-2011** CA To authorize the Finance and Management Director to renew a contract with Jani-King of Columbus for custodial services at the Fleet Maintenance building at 4211 Groves Road and to authorize the expenditure of \$25,572.00 from the Fleet Management Services Fund.(\$25,572.00)
This Matter was Approved on the Consent Agenda.

HEALTH, HOUSING & HUMAN SERVICES: CRAIG, CHR. MILLS TYSON GINTHER

- 0169-2011** CA To authorize and direct the Columbus Health Department to accept a grant from the Ohio Department of Health in the amount of \$166,831.00 for the Dental Sealant Program; to authorize the appropriation of \$166,831.00 from the unappropriated balance of the Health Department Grants Fund; and to declare an emergency. (\$166,831.00)
This Matter was Approved on the Consent Agenda.
- 0197-2011** CA To authorize the Director of the Department of Finance and Management to expend \$10,321.47 from the CDBG revolving loan fund for payment of interest earnings to the U.S. Department of Housing and Urban Development (HUD); and to declare an emergency. (\$10,321.47)

This Matter was Approved on the Consent Agenda.

0201-2011 CA

To authorize the Board of Health to enter into a contract with United Security, LLC, for security officer services; to authorize a total expenditure of \$315,000.00 from the Health Special Revenue Fund; and to declare an emergency. (\$315,000.00)

This Matter was Approved on the Consent Agenda.**RECREATION & PARKS: KLEIN, CHR. MILLS TYSON GINTHER**

0179-2011 CA To authorize and direct the Finance and Management Director to enter into contract with Agrium Advanced Technologies for herbicides, fertilizers and pesticides for the Golf Division of the Recreation and Parks Department; to authorize the expenditure of \$21,036.00 from the Golf Operating Fund; and to declare an emergency. (\$21,036.00).

This Matter was Approved on the Consent Agenda.

0183-2011 CA To authorize and direct the Finance and Management Director to enter into contract with Helena Chemical Company for herbicides, fertilizers and pesticides for the Golf Division of the Recreation and Parks Department; to authorize the expenditure of \$78,103.19 from the Golf Operating Fund; and to declare an emergency. (\$78,103.19).

This Matter was Approved on the Consent Agenda.

0184-2011 CA To authorize and direct the Finance and Management Director to enter into contract with Trupointe Corporation for herbicides, fertilizers and pesticides for the Golf Division of the Recreation and Parks Department; to authorize the expenditure of \$31,430.99 from the Golf Operating Fund; and to declare an emergency. (\$31,430.99).

This Matter was Approved on the Consent Agenda.**ADMINISTRATION: MILLER, CHR. PALEY TYSON GINTHER**

0077-2011 CA To authorize the Director of the Department of Technology and the Director of Public Utilities to renew an existing contract with VESOFT Inc. for software maintenance and support services; in accordance with the sole source provisions of the Columbus City Code; and to authorize the expenditure of \$925.00 from the Department of Technology, Internal Services Fund. (\$925.00)

This Matter was Approved on the Consent Agenda.

0084-2011 CA To authorize the Director of the Department of Technology to renew an annual hardware/software maintenance and support contract with Seachange International, in accordance with the sole source provisions of the Columbus City Codes and to authorize the expenditure of \$12,960.00 from the Department of Technology, Information Services Division, Internal Services Fund. (\$12,960.00)

This Matter was Approved on the Consent Agenda.**PUBLIC SAFETY & JUDICIARY: MILLS, CHR. CRAIG PALEY GINTHER**

0092-2011 CA To authorize the Director of Public Safety to modify and extend the current contract with Mount Carmel Occupational Health for testing services for the

Division of Fire's Health and Physical Fitness Program; to authorize the expenditure of \$750,000.00 from the General Fund; and to declare an emergency. (\$750,000.00)

This Matter was Approved on the Consent Agenda.

- 0163-2011 CA To authorize and direct the Mayor of the City of Columbus to accept a subgrantee award through the FY2010 Paul Coverdell National Forensic Science Improvement Act via the State of Ohio Office of Criminal Justice Services; to authorize Jami St. Clair, Crime Lab Manager, as the official city representative to act in connection with the subgrant; to authorize an appropriation of \$52,975.43 from the unappropriated balance of the General Government Grant Fund to the Division of Police to cover the costs of the subgrant project; and to declare an emergency (\$52,975.43).

This Matter was Approved on the Consent Agenda.

- 0170-2011 CA To appropriate and transfer \$696,287.00 within the General Permanent Improvement Fund; to authorize the Finance and Management Director to enter into a contract with Statewide Emergency Products for the purchase of light bars and sirens for the Division of Police; to authorize the expenditure of \$67,779.00 from the General Permanent Improvement Fund; and to declare an emergency. (\$67,779.00)

This Matter was Approved on the Consent Agenda.

- 0180-2011 CA To authorize an appropriation of \$240,525.00 from the unappropriated balance of the Law Enforcement Contraband Seizure Funds to purchase various law enforcement items, to fund travel and training needs and to refund monies for claims for the Division of Police, and to declare an emergency. (\$240,525.00)

This Matter was Approved on the Consent Agenda.

PUBLIC SERVICE & TRANSPORTATION: PALEY, CHR. CRAIG MILLER GINTHER

- 0176-2011 CA To authorize the expenditure of \$77,725.00 or so much thereof as may be necessary to allow the City Attorney's Office, Real Estate Division, to complete the court ordered acquisition of Parcel 5 WD, T from Zaheer Fuel, LLC for the Hudson Street and High Street intersection improvements from the Build America Bonds Fund; to amend the 2010 C.I.B.; to authorize the transfer of monies within the Build America Bonds Fund; and to declare an emergency. (\$77,725.00)

This Matter was Approved on the Consent Agenda.

- 0187-2011 CA To authorize the Director of Public Service to modify and extend various maintenance contracts with Elite Protection Services, CH Bradshaw Company Inc., Advanced Fuel Systems, MH Logistics Corp., and Silco Fire Protection Co.; to authorize the expenditure of \$15,700.00 from the General Fund and to declare an emergency. (\$15,700.00)

This Matter was Approved on the Consent Agenda.

PUBLIC UTILITIES: PALEY, CHR. CRAIG KLEIN GINTHER

- 1812-2010 CA To authorize the Director of Public Utilities to enter into a sole-source contract with the Operator Training Committee of Ohio (OTCO), for utility operations and maintenance training, in accordance with the sole source

provisions of the Columbus City Code, for the Department of Public Utilities, and to authorize the expenditure of \$3,660.00 from the Electricity Operating Fund, \$26,100.00 from the Sewerage System Operating Fund , \$6,960.00 from the Storm Sewer Operating Fund and \$23,280.00 from the Water Systems Operating Fund. (\$60,000.00)

This Matter was Approved on the Consent Agenda.

- 0042-2011 CA To authorize the Director of Public Utilities to enter into a professional design services agreement with Chester Engineers, Inc. for the Jackson Pike Wastewater Treatment Plant Corrosion Prevention and Protective Coating Systems Project; and to expend \$500,000.00 in funds from the Sanitary Sewer System GO Bond Fund for the Division of Sewerage and Drainage. (\$500,000.00).

This Matter was Approved on the Consent Agenda.

- 0043-2011 CA To authorize the Director of Public Utilities to enter into an agreement with Korda/Nemeth Engineering, Inc. for professional engineering services for the Kinnear Road Area Water Line Improvements Project; to authorize a transfer and expenditure within the Water Works Enlargement Voted Bonds Fund; for the Division of Power and Water; and to amend the 2010 Capital Improvements Budget. (\$163,525.00)

This Matter was Approved on the Consent Agenda.

- 0117-2011 CA To authorize the Director of Finance and Management to establish Blanket Purchase Orders for Heating Oil from an established State of Ohio Cooperative Purchase Contract with Great Lakes Petroleum Company for the Division of Sewerage and Drainage, to authorize the expenditure of \$675,000.00 from the Sewerage System Operating Fund, and to declare and emergency. (\$675,000.00)

This Matter was Approved on the Consent Agenda.

APPOINTMENTS

- A0090-2010 CA Appointment of Ted Hardesty 1400 Goodale Blvd. Columbus, Ohio 43212 to serve on the Downtown Commission with a term expiration date of June 1, 2014 (resume attached).

This Matter was Read and Approved on the Consent Agenda.

- A0169-2010 CA Appointment of Robert Palmer of 185 Rustic Place Columbus, Ohio 43214 to serve on the Historic Resources Commission with a term expiration date of June 30, 2013 (resume attached).

This Matter was Read and Approved on the Consent Agenda.

- A0008-2011 CA Appointment of Kate Christobek, 1333 W. Third Avenue, Columbus, Ohio 43212 to serve on the Charitable Solicitations Board with a term expiration date of June 30, 2015. (resume attached).

This Matter was Read and Approved on the Consent Agenda.

- A0009-2011 CA Appointment of Gladys Murray, 2432 Koebel Avenue, Columbus, Ohio 43207 to serve on the Far South Side Area Commission with a term expiration date of June 30, 2013 (resume attached).

This Matter was Read and Approved on the Consent Agenda.

- A0010-2011** CA Appointment of Mary Ellen Wewers, Ohio State University, 320 West 10th Ave. Columbus, Ohio 43210 to serve on the Columbus Board of Health with a term expiration of January 31, 2015 (resume attached).
This Matter was Read and Approved on the Consent Agenda.
- A0011-2011** CA Appointment of Liz Cabot, 258 Winthrop Road, Columbus Ohio 43214, to serve on the Columbus Horticultural Subcommittee, with a new term expiration date of April 30, 2015. (resume attached)
This Matter was Read and Approved on the Consent Agenda.
- A0012-2011** CA Appointment of David Paul, 2185 Blackoak Avenue, Columbus, Ohio, 43229 to serve on the Columbus Recreation and Parks Commission with a new term expiration date of December 31, 2015 (resume attached).
This Matter was Read and Approved on the Consent Agenda.
- A0013-2011** CA Reappointment of Jamie Roberson of 750 North High Street #10 H, Columbus, Ohio 43215 to serve on the Columbus Metropolitan Housing Authority with a new term expiration of October 31, 2015 (resume attached).
This Matter was Read and Approved on the Consent Agenda.
- A0015-2011** CA Appointment of Mario Ciardelli, 4369 Sandy Lane Road, Columbus, Ohio 43224 to serve on the Columbus Building Commission with a term expiration date of February 28, 2014 (resume attached).
This Matter was Read and Approved on the Consent Agenda.
- A0016-2011** CA Appointment of Jim K. Bubutiev, 1262 Villa Oak Court, Gahanna, Ohio 43230 to serve on the Board of Zoning Adjustment with an expiration date of March 31, 2014 (resume attached).
This Matter was Read and Approved on the Consent Agenda.

Passed The Consent Agenda

A motion was made by President Pro-Tem Craig, seconded by Klein, including all the preceding items marked as having been approved on the Consent Agenda. The motion carried by the following vote:

Absent: 1 - Tyson

Affirmative: 6 - President Pro-Tem Craig, Klein, Miller, Mills, Paley and President Ginther

EMERGENCY, TABLED AND 2ND READING OF 30-DAY LEGISLATION

FINANCE: TYSON, CHR. MILLER PALEY GINTHER

- 0173-2011** To appropriate \$1,701,803.00 within the Special Income Tax Fund for the Finance and Management Department, Real Estate Management Office; to authorize the Finance and Management Director to renew, extend, and make rent payments for various lease agreements for the lease of office and warehouse space for the Department of Public Safety and the lease of office space for the Department of Development; to authorize the expenditure of \$1,586,803.00 from the Special Income Tax Fund; and to declare an emergency. (\$1,701,803.00)

TABLED UNTIL 2/28/2011

A motion was made by Paley, seconded by President Pro-Tem Craig, that this matter be Tabled to Certain Date. The motion carried by the following vote:

Absent: 1 - Tyson

Abstained: 2 - Miller and Mills

Affirmative: 4 - President Pro-Tem Craig, Klein, Paley and President Ginther

0218-2011

To authorize the Director of Finance and Management to enter into a subscription agreement with KOREnergy, to allow the participation in the PJM demand response programs for the one or more City facilities; to waive the City Code provisions for competitive bidding; and to declare an emergency.

A motion was made by Miller, seconded by President Pro-Tem Craig, that this matter be Approved. The motion carried by the following vote:

Absent: 1 - Tyson

Affirmative: 6 - President Pro-Tem Craig, Klein, Miller, Mills, Paley and President Ginther

HEALTH, HOUSING & HUMAN SERVICES: CRAIG, CHR. MILLS TYSON GINTHER

0166-2011

To authorize and direct the Columbus Health Department to accept a grant from the Franklin County Board of Commissioners in the amount of \$1,200,000.00 for the continued operation of the Ben Franklin Tuberculosis Clinic; to authorize the appropriation of \$1,200,000.00 from the unappropriated balance of the Health Department Grants Fund, and to declare an emergency. (\$1,200,000.00)

A motion was made by President Pro-Tem Craig, seconded by Paley, that this matter be Approved. The motion carried by the following vote:

Absent: 1 - Tyson

Affirmative: 6 - President Pro-Tem Craig, Klein, Miller, Mills, Paley and President Ginther

0192-2011

To authorize and direct the Board of Health to accept additional grant monies from the Ohio Department of Health in the amount of \$1,054,751.00; to authorize the appropriation of \$1,054,751.00 from the unappropriated balance of the Health Department Grants Fund; and to declare an emergency. (\$1,054,751.00)

A motion was made by President Pro-Tem Craig, seconded by Klein, that this matter be Approved. The motion carried by the following vote:

Absent: 1 - Tyson

Affirmative: 6 - President Pro-Tem Craig, Klein, Miller, Mills, Paley and President Ginther

0207-2011

To authorize the Director of the Department of Development to enter into contracts with various non-profit organizations for the implementation of the Chores Program; to authorize the expenditure of \$150,000.00 from the Community Development Block Grant Fund; and to declare an emergency. (\$150,000.00)

A motion was made by President Pro-Tem Craig, seconded by Paley, that this matter be Approved. The motion carried by the following vote:

Absent: 1 - Tyson

Affirmative: 6 - President Pro-Tem Craig, Klein, Miller, Mills, Paley and President Ginther

0219-2011

To authorize an appropriation of \$725,000.00 from the HOME Fund to provide funding for various approved 2011 programs; and to declare an emergency. (\$725,000.00)

A motion was made by President Pro-Tem Craig, seconded by Mills, that this matter be Approved. The motion carried by the following vote:

Absent: 1 - Tyson

Affirmative: 6 - President Pro-Tem Craig, Klein, Miller, Mills, Paley and President Ginther

0220-2011

To authorize the Director of the Department of Development to enter into contract with the Southeast, Inc to provide tenant-based rental assistance; to authorize the expenditure of \$161,000.00 from the HOME Fund; and to declare an emergency. (\$161,000.00)

A motion was made by President Pro-Tem Craig, seconded by Paley, that this matter be Approved. The motion carried by the following vote:

Absent: 1 - Tyson

Affirmative: 6 - President Pro-Tem Craig, Klein, Miller, Mills, Paley and President Ginther

0221-2011

To authorize the Director of the Department of Development to enter into a contract with the YMCA of Central Ohio to provide tenant-based rental assistance; to authorize the expenditure of \$164,000.00 from the HOME Fund; and to declare an emergency. (\$164,000.00)

A motion was made by President Pro-Tem Craig, seconded by Mills, that this matter be Approved. The motion carried by the following vote:

Absent: 1 - Tyson

Affirmative: 6 - President Pro-Tem Craig, Klein, Miller, Mills, Paley and President Ginther

DEVELOPMENT: KLEIN, CHR. MILLER TYSON GINTHER

0217-2011

To amend ordinance 1298-2010, passed by Columbus City Council on September 20, 2010, to extend the period of execution for the Jobs Creation Tax Credit and the Jobs Growth Incentive Agreements with International Technical Coatings, Inc.; and to declare an emergency.

A motion was made by Klein, seconded by President Pro-Tem Craig, that this matter be Approved. The motion carried by the following vote:

Absent: 1 - Tyson

Affirmative: 6 - President Pro-Tem Craig, Klein, Miller, Mills, Paley and President Ginther

RECREATION & PARKS: KLEIN, CHR. MILLS TYSON GINTHER

0148-2011 To accept 22.80 +/- acres of real property donated to the City of Columbus by Janet Anderson Trustee, Janet Anderson, and Anderson Farms LTD, LLC, an Ohio limited liability company, collectively; to authorize the Director of Recreation and Parks to execute an Agreement Regarding Real Estate Taxes with Schottenstein Homes, LLC, an Ohio Limited Liability Company; to place additional restrictive/environmental covenants on the property in order to preserve its natural environmental value; and to declare an emergency.

A motion was made by Klein, seconded by President Pro-Tem Craig, that this matter be Approved. The motion carried by the following vote:

Absent: 1 - Tyson

Affirmative: 6 - President Pro-Tem Craig, Klein, Miller, Mills, Paley and President Ginther

0185-2011 To authorize the Director of Recreation and Parks to accept a grant and enter into agreement with the Ohio Department of Natural Resources; to provide for the appropriation of said funds to the Recreation and Parks Grant Fund; and to declare an emergency. (\$485,000.00)

A motion was made by Klein, seconded by President Pro-Tem Craig, that this matter be Approved. The motion carried by the following vote:

Absent: 1 - Tyson

Affirmative: 6 - President Pro-Tem Craig, Klein, Miller, Mills, Paley and President Ginther

0188-2011 To authorize and direct the Director of Recreation and Parks to accept a grant to provide outreach to eligible Medicare beneficiaries in Central Ohio in the amount of \$57,428.00; to authorize an appropriation of \$57,428.00 from the unappropriated balance of the Recreation and Parks Grant Fund to the Recreation and Parks Department; and to declare an emergency. (\$57,428.00)

A motion was made by Klein, seconded by President Pro-Tem Craig, that this matter be Approved. The motion carried by the following vote:

Absent: 1 - Tyson

Affirmative: 6 - President Pro-Tem Craig, Klein, Miller, Mills, Paley and President Ginther

ADMINISTRATION: MILLER, CHR. PALEY TYSON GINTHER

0079-2011 To authorize the Director of the Department of Technology (DoT) to renew an annual software license, maintenance and support contract with B & L Associates Inc. for the BL/LIB Tape Library Management System; in accordance with the sole source provisions of the Columbus City Code; and to authorize the expenditure of \$14,185.00 from the Department of Technology, Information Services Division, internal service fund. (\$14,185.00)

A motion was made by Miller, seconded by President Pro-Tem Craig, that this matter be Approved. The motion carried by the following vote:

Absent: 1 - Tyson

Affirmative: 6 - President Pro-Tem Craig, Klein, Miller, Mills, Paley and President Ginther

0132-2011

To authorize the Director of the Department of Technology and the Director of the Civil Service Commission, on behalf of the Civil Service Commission, to renew an existing agreement for maintenance, support and license from Governmentjobs.com; to authorize this ordinance in accordance with the sole source provisions of the Columbus City Codes; to authorize the expenditure of \$17,828.00 from the Department of Technology, internal service fund; and to declare an emergency. (\$17,828.00)

A motion was made by Miller, seconded by President Pro-Tem Craig, that this matter be Approved. The motion carried by the following vote:

Absent: 1 - Tyson

Affirmative: 6 - President Pro-Tem Craig, Klein, Miller, Mills, Paley and President Ginther

PUBLIC SAFETY & JUDICIARY: MILLS, CHR. CRAIG PALEY GINTHER

0097-2011

To authorize and direct the Director of Public Safety to enter into a contract with Medtronic Emergency Response Systems for the purchase of defibrillators and related equipment and operating supplies in accordance with sole source procurement provisions; to authorize the expenditure of \$355,064.20 from the Safety Voted Bond Fund; and to declare an emergency.(\$355,064.20)

A motion was made by Mills, seconded by Paley, that this matter be Approved. The motion carried by the following vote:

Absent: 1 - Tyson

Affirmative: 6 - President Pro-Tem Craig, Klein, Miller, Mills, Paley and President Ginther

0145-2011

To authorize and direct the Director of Public Safety to renew the contract for helicopter maintenance with Helicopter Minit-Men, Inc. for the Division of Police under the provisions of sole source procurement, to authorize the expenditure of \$562,010.00 from the General Fund; and to declare an emergency. (\$562,010.00)

A motion was made by Mills, seconded by President Pro-Tem Craig, that this matter be Approved. The motion carried by the following vote:

Absent: 1 - Tyson

Affirmative: 6 - President Pro-Tem Craig, Klein, Miller, Mills, Paley and President Ginther

0153-2011

To amend the Department of Public Safety's 2010 Capital Improvement Budget, to authorize the City Auditor to transfer funds between projects in the Safety Voted Bond Fund, to authorize the Director of The Department of Public Safety to enter into an agreement with the Franklin County Emergency Management and Homeland Security agency for the purchase and installation of the City of Columbus' portion of the outdoor warning siren system, to authorize the expenditure of \$200,000.00 from the Voted Public Safety Bond Fund, and to declare an emergency. (\$200,000.00)

A motion was made by Mills, seconded by President Pro-Tem Craig, that this matter be Approved. The motion carried by the following vote:

Absent: 1 - Tyson

Affirmative: 6 - President Pro-Tem Craig, Klein, Miller, Mills, Paley and President Ginther

0171-2011

To authorize an appropriation of \$9,750.00 from the unappropriated balance of the Special Purpose Fund to the Division of Police to provide partial funding for the costs associated with the Columbus Police Reserves Organization; and to declare an emergency. (\$9,750.00)

A motion was made by Mills, seconded by President Pro-Tem Craig, that this matter be Approved. The motion carried by the following vote:

Absent: 1 - Tyson

Affirmative: 6 - President Pro-Tem Craig, Klein, Miller, Mills, Paley and President Ginther

PUBLIC SERVICE & TRANSPORTATION: PALEY, CHR. CRAIG MILLER GINTHER

0168-2011

To authorize the Director of Public Service to execute a planned contract modification with Rumpke of Ohio, Inc., for yard-waste collection services; to authorize the expenditure of \$3,824,496.00 or so much thereof as may be needed from the General Fund for the second year of the contract, and to declare an emergency. (\$3,824,496.00)

A motion was made by Paley, seconded by President Pro-Tem Craig, that this matter be Approved. The motion carried by the following vote:

Absent: 1 - Tyson

Affirmative: 6 - President Pro-Tem Craig, Klein, Miller, Mills, Paley and President Ginther

0186-2011

To authorize the appropriation and expenditure of \$310,000.00 or so much thereof as may be necessary for the payment of Utility Relocation expenses for various Utilities for the Parsons/Livingston Avenue Improvements project from the Fed-State Highway Engineering Fund; to amend the 2010 C.I.B.; to authorize the transfer of funds from the Build America Bonds Fund to the Fed-State Highway Engineering Fund; and to declare an emergency. (\$310,000.00)

A motion was made by Paley, seconded by President Pro-Tem Craig, that this matter be Approved. The motion carried by the following vote:

Absent: 1 - Tyson

Affirmative: 6 - President Pro-Tem Craig, Klein, Miller, Mills, Paley and President Ginther

0191-2011

To authorize the Director of Public Service to enter into a professional service engineering contract with Stantec Consulting Services, Inc. for the Bikeway Development - Professional Services project; to amend the 2010 C.I.B.; to authorize the transfer and expenditure of \$310,000.00 from within the Build America Bonds Fund; for the Division of Mobility Options; and to declare an emergency. (\$310,000.00)

A motion was made by Paley, seconded by President Pro-Tem Craig, that this matter be Approved. The motion carried by the following vote:

Absent: 1 - Tyson

Affirmative: 6 - President Pro-Tem Craig, Klein, Miller, Mills, Paley and President Ginther

PUBLIC UTILITIES: PALEY, CHR. CRAIG KLEIN GINTHER

0033-2011

To authorize the Director of Public Utilities to enter into contract with John Eramo & Sons, Inc. for the 2010 General Construction Contract Project (worked to be performed in 2011) in the amount of \$1,567,100.00 for the Division of Sewerage and Drainage, to authorize the transfer within and expenditure of funds from the G.O. Sanitary Sewer Fund, and to amend the 2010 Capital Improvement Budget. (\$1,567,100.00.)

A motion was made by Paley, seconded by President Pro-Tem Craig, that this matter be Approved. The motion carried by the following vote:

Absent: 1 - Tyson

Affirmative: 6 - President Pro-Tem Craig, Klein, Miller, Mills, Paley and President Ginther

0050-2011

To authorize the Director of Finance and Management to establish a purchase order for the purchase of one Easement Cleaning Machine with Trailer in accordance with a State of Ohio contract with Jack Doheny Supplies Ohio, Inc. for the Division of Sewerage and Drainage, to waive the provisions of competitive bidding and to authorize the expenditure of \$45,017.10 from the Sewerage System Operating Fund. (\$45,017.10)

A motion was made by Paley, seconded by President Pro-Tem Craig, that this matter be Approved. The motion carried by the following vote:

Absent: 1 - Tyson

Affirmative: 6 - President Pro-Tem Craig, Klein, Miller, Mills, Paley and President Ginther

0069-2011

To authorize the Director of Public Utilities to enter into contract with the Armada Ltd., to conduct an Introductory Workshop and Tabletop Exercise of the existing Emergency Action Plans (EAP's) for the Griggs, Hoover and O'Shaughnessy Dams as well as a Functional Exercise of the O'Shaughnessy Dam EAP as recommended by ODNR and required by FERC, for the Division of Power and Water; to waive competitive bidding provisions of section 329.06 of the Columbus City Code; and to authorize the expenditure of \$33,400.00. (\$33,400.00).

A motion was made by Paley, seconded by President Pro-Tem Craig, that this matter be Approved. The motion carried by the following vote:

Absent: 1 - Tyson

Affirmative: 6 - President Pro-Tem Craig, Klein, Miller, Mills, Paley and President Ginther

0134-2011

To authorize the Director of Public Utilities to modify and increase the agreement with URS Corporation - Ohio for Professional Construction Management Services; for the Division of Power and Water; to authorize a

transfer and expenditure of \$1,625,000.00 within the Water Build America Bonds Fund; to authorize an amendment to the 2010 Capital Improvements Budget; and to declare an emergency. (\$1,625,000.00)

A motion was made by Paley, seconded by President Pro-Tem Craig, that this matter be Approved. The motion carried by the following vote:

Absent: 1 - Tyson

Affirmative: 6 - President Pro-Tem Craig, Klein, Miller, Mills, Paley and President Ginther

RULES & REFERENCE: GINTHER, CHR. KLEIN PALEY MILLS

0125-2011

To amend Section 323.07 of the Columbus City Codes in order to comply with changes to SEC requirements relative to the disclosure of information on bonds and notes issued by the City.

Sponsors: Priscilla Tyson

A motion was made by President Ginther, seconded by President Pro-Tem Craig, that this matter be Amended as submitted to the Clerk. The motion carried by the following vote:

Absent: 1 - Tyson

Affirmative: 6 - President Pro-Tem Craig, Klein, Miller, Mills, Paley and President Ginther

A motion was made by President Ginther, seconded by President Pro-Tem Craig, that this matter be Approved as Amended. The motion carried by the following vote:

Absent: 1 - Tyson

Affirmative: 6 - President Pro-Tem Craig, Klein, Miller, Mills, Paley and President Ginther

ADJOURNMENT

ADJOURNED 6:11 PM

A motion was made by President Pro-Tem Craig, seconded by Paley, to adjourn this Regular Meeting. The motion carried by the following vote:

Absent: 1 - Tyson

Affirmative: 6 - President Pro-Tem Craig, Klein, Miller, Mills, Paley and President Ginther

THERE WILL BE NO COUNCIL MEETING ON MONDAY, FEBRUARY

21, 2011 IN OBSERVANCE OF PRESIDENT'S DAY. THE NEXT

REGULAR COUNCIL MEETING WILL BE, MONDAY, FEBRUARY 28, 2011

Ordinances and Resolutions

**City of Columbus
City Bulletin Report**

Office of City Clerk
90 West Broad Street
Columbus OH 43215-9015
columbuscitycouncil.org

Legislation Number: 0019X-2011

Drafting Date: 02/08/2011

Current Status: Passed

Version: 1

Matter Type: Resolution

Title

To honor the National Council of Jewish Women, Columbus Section, for their tireless efforts in helping reduce teen dating abuse and to recognize February as National Teen Dating Violence Prevention and Awareness Month.

Body

WHEREAS, Teen Dating Violence Prevention and Awareness Month is a national effort to raise awareness about abuse in youth relationships and promote programs that prevent it; and

WHEREAS, one in every three teenagers will experience an abusive dating relationship by the time they graduate from high school or college, and 10 percent of adolescents report being physically abused by a romantic partner; and

WHEREAS, research from the Centers for Disease Control and Prevention indicate that dating abuse victims are more likely to engage in binge drinking, suicide attempts, physical fights and sexual activity, as well as having double the likelihood of using drugs, alcohol and tobacco; and

WHEREAS, the National Council of Jewish Women, Columbus Section, has initiated a community-wide effort to prevent teen dating abuse through its Love Shouldn't Hurt program; and

WHEREAS, Love Shouldn't Hurt helps students identify the warning signs of abusive relationships, the foundations of healthy relationships, and a safe strategy to break free from harmful relationships; and

WHEREAS, the National Council of Jewish Women, Columbus Section, has also launched a public awareness program to reach teens, parents, educators and the general public, with billboards, newspaper ads, public service announcements, and posters; and

WHEREAS, the National Council of Jewish Women is a volunteer organization, inspired by Jewish values, that works to improve the quality of life for all women, children and families and to ensure individual rights and freedoms for all through its network of 90,000 members, supporters and volunteers nationwide, and over 600 members and volunteers in the greater Columbus area; now therefore

BE IT RESOLVED BY THE COUNCIL OF THE CITY OF COLUMBUS:

That this Council honors the National Council of Jewish Women, Columbus Section, for their tireless efforts in helping reduce teen dating abuse and recognizes February as National Teen Dating Violence Prevention and Awareness Month.

Legislation Number: 0033-2011

Drafting Date: 01/06/2011

Current Status: Passed

Version: 1

Matter Type: Ordinance

Explanation

1. **BACKGROUND:**

This legislation authorizes the Director of Public Utilities to execute a construction contract with the John Eramo & Sons, Inc., in the amount of \$1,566,100.00 for the construction of the 2010 General Construction Contract Project and for the Division of Sewerage and Drainage, plus \$1,000.00 in funding for prevailing wages cost, and to authorize transfer within and the total expenditure of \$1,567,100.00 from the G.O. Sanitary Sewer Bond Fund, and to amend the 2010 Capital Improvement Budget.

The work to be completed by this contract consists of raising manhole frames or reconstructing manholes to grade, repair of State Route 315 storm inlets, and sewer point repairs and such other work as may be necessary to complete the contract in accordance with the plans and specifications. Work is to be completed within 365 calendar days after the effective date of the Notice to Proceed.

Note: The name of this project is the 2010 General Construction Contract Project. The work for this project will occur in calendar year 2011.

Procurement Information: The Division advertised for competitive bid proposals on the City of Columbus's Vendor Services website and in the City Bulletin in accordance with the provisions of Section 329.14 of Columbus City Codes. The Division of Sewerage and Drainage opened four competitive bid proposals on December 8, 2010. The bid order for the following companies was as follows:

John Eramo & Sons, Inc.	31-0724866 02/05/2012 \$1,566,100.00
Danbert Inc.	31-1029004 08/26/2012 \$1,571,012.00
Complete General Construction. Co.	31-4366382 12/15/2011 \$1,832,740.00
The Righter Co., Inc.	31-0889208 04/07/2011 \$1,982,880.00

The Engineer's construction cost estimate was: \$1,978,990.00

These bids were reviewed and ranked utilizing the Bid Tab and Quality Factor Form evaluation process. After careful consideration, the committee recommended that John Eramo & Sons, Inc. be selected to provide the construction services for the 2010 General Construction Contract Project.

This company is not debarred or prohibited from being awarded a contract according to the Auditor of State unresolved findings for recovery certified search.

2. CONTRACT COMPLIANCE INFO:

John Eramo & Sons, Inc. | 31-0724866 | Exp. 02/05/2012 | Maj

3. EMERGENCY DESIGNATION: Emergency designation is not requested at this time.

4. FISCAL IMPACT:

This ordinance authorizes the transfer within of \$67,100.00, of which \$1000 is for Prevailing Wage cost, and to expend a total of \$1,567,100.00 from the G.O. Sanitary Sewer Bond Fund, Fund 664 (contract amount \$1,566,100.00 plus \$1,000.00 prevailing wage cost), and to amend the 2010 Capital Improvement Budget to establish sufficient budget authority for this ordinance.

Title

To authorize the Director of Public Utilities to enter into contract with John Eramo & Sons, Inc. for the 2010 General Construction Contract Project (worked to be performed in 2011) in the amount of \$1,567,100.00 for the Division of Sewerage and Drainage, to authorize the transfer within and expenditure of funds from the G.O. Sanitary Sewer Fund, and to amend the 2010 Capital Improvement Budget. (\$1,567,100.00.)

Body

WHEREAS, four competitive bids for the construction of the 2010 General Construction Contract Project were received on December 8, 2010, whereupon it was determined that the John Eramo & Sons, Inc., submitted the lowest, best, responsive and responsible bid proposal; and

WHEREAS, the work consists of raising manhole frames or reconstructing manholes to grade, repair of storm inlets, and sewer point repairs; and

WHEREAS, it is necessary to authorize the transfer within of funds from the G.O. Sanitary Sewer Fund, Fund 664 for purposes of providing sufficient funding for the sanitary expenditure; and

WHEREAS, it is necessary to provide funding for prevailing wages in the amount of \$1,000.00

WHEREAS, it is necessary for City Council to authorize the expenditure of funds from the G.O. Sanitary Sewer Bond Fund, Fund 664; and

WHEREAS, it is necessary to authorize an amendment the 2010 Amend Capital Improvement Budget for purposes of creating and providing sufficient budget authority for the aforementioned expenditure; and

WHEREAS, the aggregate principal amount which the City will issue to finance this phase of the project is presently expected not to exceed \$1,567,100.00; and

WHEREAS, the Department of Public Utilities, Division of Sewerage and Drainage request that City Council authorize the Director of Public Utilities, to enter a contract with John Eramo & Sons, Inc., for the 2010 General Construction Contract Project, at the earliest practical date; **Now, Therefore**

BE IT ORDAINED BY THE COUNCIL OF THE CITY OF COLUMBUS:

Section 1. That this legislation and City Council authorizes the Director of Public Utilities to enter into a construction contract with the John Eramo & Sons, Inc., 3670 Lacon Road, Hilliard, Ohio 43026, for the 2010 General Construction Contract Project(worked to be performed in 2011) for the Division of Sewerage and Drainage for the work consists of raising manhole frames or reconstructing manholes to grade, repair of storm inlets, and sewer point repairs.

Section 2. That the City Auditor is hereby authorized to transfer \$67,100.00 within the Department of Public Utilities Division of Sewerage and Drainage, Dept/Div. No. 60-05, Sewerage and Drainage G.O. Sanitary Sewer Bond Fund, Fund No. 664, Object Level Three 6630, as follows:

From:

Project No. | Project Name | OCA Code | Change

650346-100000 | SWWTP Electrical Systems Improvements | 650346 | -\$4977.00

650673-100000 | Upper Adena Brook | 664673 | -\$62,123.00

To:

Project No. | Project Name | OCA Code | Change

650745-100002 | 2010 General Construction Contract | 650745 | 67,100.00

Section 3. That the Director of Public Utilities be and hereby is authorized to expend a total of \$1,567,100.00 from the G.O. Sanitary Sewer Fund | Fund 664 | Div. 60-05 | Proj. 650745-100002 | 650745 | Object Level Three 6630.

Section 4. That the 2010 Capital Improvements Budget Ordinance No. 0564-2010 is hereby amended as follows, to provide sufficient budget authority for the award of the agreement stated herein.

Project No. | Project Name | Current Authority | Revised Authority | (Change)

650346-100000 | SWWTP Electrical Systems Improvements | \$4,977 | \$0 | (-\$4977)

650673-100000 | Upper Adena Brook | \$62,513 | \$390 | (-\$62,123)

650745-100002 | 2010 General Construction Contract | \$1,500,000 | \$1,567,100 | (+\$67,100)

Note: \$1,000 to be left on the AC for Prevailing Wages

Section 5. That the said firm shall perform the work to the satisfaction of the Director of Public Utilities and the Administrator of the Division of Sewerage and Drainage.

Section 6. That the City Auditor is hereby authorized and directed to transfer any unencumbered balance in the project account to the unallocated balance within the same fund upon receipt of certification by the Director of the Department administering said project that the project has been completed and the monies no longer required for said project; except that no transfer shall be made from a project account by monies from more than one source.

Section 7. That the City Auditor is authorized to establish proper project accounting numbers as appropriate.

Section 8. That the City Auditor is authorized to make any accounting changes to revise the funding source for all contracts or contract modifications associated with this ordinance.

Section 9. That this ordinance shall take effect and be in force from and after the earliest period allowed by law.

Legislation Number: 0042-2011

Drafting Date: 01/06/2011

Current Status: Passed

Version: 1

Matter Type: Ordinance

Explanation

1. **BACKGROUND:**

A. **Need.** This legislation authorizes the Director of Public Utilities to enter into a professional design services agreement with Chester Engineers, Inc. for the Jackson Pike Wastewater Treatment Plant Corrosion Prevention and Protective Coating Systems Project for the Division of Sewerage and Drainage. The Division has determined that these services cannot be performed by City personnel at this time, and has planned for the procurement of these services on a routine basis.

It has been determined that the protective coatings on many plant structures, buildings and process items are in need of rehabilitation. This project will implement a study and prepare a report indicating the specific areas, structures and process items in need of attention, the procedures necessary for the rehabilitation, and the steps necessary to inhibit deterioration in the future. It will also prepare a General Corrosion Prevention and Protective Coating Specification and prepare electronic bid documents for Corrosion Prevention and Protective Coating applications for the locations selected by the City. The actual emplacement of the designed work will be by construction contract; this Design Professional (DP) services contract will provide: preliminary design, detailed design, bidding assistance, construction-phase engineering, start-up and commissioning assistance, record documentation preparation assistance, and other services for this project, as directed by the City.

The contract shall be funded by incremental appropriation, through the use of modifications. This original award will provide funding for the Preliminary and Detailed Design. The future needs for services during construction are anticipated to begin in 2011, at which time a future modification is planned. A modification for services during construction is anticipated for each construction contract. The overall contract duration, from initiation of Preliminary Design services to completion of services during construction, is estimated to be 7 years. The following is an estimate of costs for the contract:

<u>Original Contract</u>	\$ 500,000.00
Future Modification No. 1	\$ 150,000.00
Future Modification No. 2	\$ 150,000.00
Future Modification No. 3	\$ 150,000.00

Future Modification No. 4	\$ 150,000.00
Future Modification No. 5	\$ 150,000.00
Future Modification No. 6	<u>\$ 150,000.00</u>
CURRENT PROPOSED TOTAL	\$ 1,400,000.00

B. Procurement Information: The basis for selection of the chosen professional engineering services firm: The Division advertised Request for Proposals (RFP's) for the subject services in the City Bulletin in accordance with the provisions of Section 329.14 of Columbus City Codes. The Division of Sewerage and Drainage received technical proposals on September 15, 2010 from Chester Engineers, Inc. and Donahue Ideas, LLC. These proposals were reviewed and ranked by a Professional Engineering Services Selection Committee in order to determine the consultant best qualified to provide the services for this project. The committee ranked the proposals on quality and feasibility. After careful consideration, the committee recommended that Chester Engineers, Inc. be selected to provide the engineering services for this study, for which the Division Administrator has concurred.

This company is not debarred according to the Federal Excluded Parties Listing or the State Auditor's Findings for Recovery Database.

C. **Contract Compliance No.:** 20-2401674 | MBE | Exp 06/04/2011

D. **Emergency Designation:** Emergency designation is not requested.

2. **FISCAL IMPACT:**

This ordinance authorizes the Director of Public Utilities to expend \$500,000.00 in funds from the Sanitary Sewer System GO (General Obligation) Bond Fund, Fund 664 for this expenditure. There is sufficient budget authority in the 2010 Capital Improvements Budget for this expenditure for the Division of Sewerage and Drainage.

Title

To authorize the Director of Public Utilities to enter into a professional design services agreement with Chester Engineers, Inc. for the Jackson Pike Wastewater Treatment Plant Corrosion Prevention and Protective Coating Systems Project; and to expend \$500,000.00 in funds from the Sanitary Sewer System GO Bond Fund for the Division of Sewerage and Drainage. (\$500,000.00).

Body

WHEREAS, the procurement was conducted in accordance with the Request For Proposals (RFP) process set forth in Section 329.14, Columbus City Codes, 1959: Two proposals were received and the Division's Evaluation Committee selected Chester Engineers, Inc. from the two firms; and

WHEREAS, the Division of Sewerage and Drainage, Department of Public Utilities, hereby requests this City Council to authorize the Director of Public Utilities to enter into an agreement for professional engineering services with Chester Engineers, Inc. for an amount of \$500,000.00 in connection with the Jackson Pike Wastewater Treatment Plant Corrosion Prevention and Protective Coating Systems project; and

WHEREAS, it is necessary for City Council to authorize the expenditure of funds from the Sanitary Sewer System GO Bond Fund, Fund 664; and

WHEREAS, the Division of Sewerage and Drainage, Department of Public Utilities is requesting that this Council authorize the Director of Public Utilities to enter into an agreement for professional engineering services with Chester Engineers, Inc. in connection with the Jackson Pike Wastewater Treatment Plant Corrosion Prevention and Protective Coating Systems project, at the earliest practicable date for the preservation of the public health, peace, property, safety and welfare; **Now, Therefore,**

BE IT ORDAINED BY THE COUNCIL OF THE CITY OF COLUMBUS:

Section 1. That the Director of Public Utilities be, and hereby is, authorized to enter into an agreement for professional engineering services with Chester Engineers, Inc. in connection with the Jackson Pike Wastewater Treatment Plant Corrosion Prevention and Protective Coating Systems project, in accordance with the terms and conditions as shown in the agreement on file in the office of the Division of Sewerage and Drainage.

Section 2. That the City Auditor be and hereby is authorized to expend a total of \$500,000.00 or as much as may be needed for the purpose of paying the cost of the professional engineering services agreement from the Sanitary Sewer System GO (General Obligation) Bond Fund, Fund 664 into the Jackson Pike Wastewater Treatment Plant Corrosion Prevention and Protective Coating Systems project | Fund 664 | Div. 60-05 | Project 650259-100001 | 650259 | Object Level Three 6676.

Section 3. That the City Auditor is hereby authorized to transfer any unencumbered balance in the project account to the unallocated balance within the same fund upon receipt of certification by the Director of the Department administering said project that the project has been completed and the monies are no longer required for said project; except that no transfer shall be made from a project by monies from more than one source.

Section 4. That the City Auditor is authorized to establish proper project accounting numbers as appropriate.

Section 5. That the City Auditor is authorized to make any accounting changes to revise the funding source for all contracts or contract modifications associated with this ordinance.

Section 6. That the contracted firm shall perform the work to the satisfaction of the Director of Public Utilities and the Administrator of the Division of Sewerage and Drainage.

Section 7. That this ordinance shall take effect and be in force from and after the earliest period allowed by law.

Legislation Number: 0043-2011

Drafting Date: 01/07/2011

Current Status: Passed

Version: 1

Matter Type: Ordinance

Explanation

1. BACKGROUND: This legislation authorizes the Director of Public Utilities to enter into an agreement with Korda/Nemeth Engineering, Inc., in the amount of \$163,525.00, for professional engineering services for the Kinnear Road Area Water Line Improvements Project, Division of Power and Water Contract No. 1160.

The purpose of this project is to construct necessary improvements to the water distribution system in the Kinnear Road Area. The improvements identified in the scope of work will replace mains that historically are in need of frequent maintenance. This project includes nine individual sites located at Kinnear Road, Gerrard Avenue, Hess Boulevard, Eleventh Avenue, Sells Avenue, Chambers Road, Kenny Road, Chesapeake Avenue, Sixth Avenue for a total of approximately 1,900 feet of 12-inch diameter water line, 3,700 feet of 8-inch diameter water line, and approximately 6,300 feet of 6-inch diameter water line.

2. BID INFORMATION: The selection of the firm providing the professional engineering services has been performed in accordance with the procedures set forth in Columbus City Code, Section 329.14, "Awarding professional service contracts through requests for proposals." Requests for Proposals (RFP's) were received on December 3, 2010 from Korda/Nemeth Engineering, Inc., Floyd Browne Group, and E. P. Ferris & Associates, Inc.

An evaluation committee reviewed the proposals and scored them based on the criteria stated in the Code. Based on the evaluation of the proposals submitted, the Director of Public Utilities requests award of the project to Korda/Nemeth Engineering, Inc.

The Contract Compliance Number for Korda/Nemeth Engineering, Inc. is 31-1194974 (expires 10/5/11, Majority). Additional information regarding each bidder, description of work, contract time frame and detailed amounts can be found on the attached Legislation Information Form.

Searches in the Excluded Party List System (Federal) and the Findings for Recovery list (State) produced no findings against Korda/Nemeth Engineering, Inc.

3. FISCAL IMPACT: This legislation includes a transfer of funds within the Water Works Enlargement Voted Bonds Fund and an amendment to the 2010 Capital Improvements Budget.

Title

To authorize the Director of Public Utilities to enter into an agreement with Korda/Nemeth Engineering, Inc. for professional engineering services for the Kinnear Road Area Water Line Improvements Project; to authorize a transfer and expenditure within the Water Works Enlargement Voted Bonds Fund; for the Division of Power and Water; and to amend the 2010 Capital Improvements Budget. (\$163,525.00)

Body

WHEREAS, three technical proposals for professional engineering services for the Kinnear Road Area Water Line Improvements Project were received on December 3, 2010; and

WHEREAS, Korda/Nemeth Engineering, Inc. was the firm selected to perform the design services for this project based on criteria set forth in Columbus City Codes; and

WHEREAS, it is necessary for this Council to authorize the City Auditor to transfer funds within the Water Works Enlargement Voted Bonds Fund; and

WHEREAS, it is necessary to authorize an amendment to the 2010 Capital Improvements Budget for purposes of providing sufficient funding and expenditure authority for the aforementioned project expenditure; and

WHEREAS, it has become necessary in the usual daily operation of the Division of Power and Water, Department of Public Utilities, to authorize the Director of Public Utilities to enter into an agreement for professional engineering services for the Kinnear Road Area Water Line Improvements Project, for the preservation of the public health, peace, property and safety;

BE IT ORDAINED BY THE COUNCIL OF THE CITY OF COLUMBUS:

SECTION 1. That the Director of Public Utilities be and hereby is authorized to enter into an agreement for professional engineering services for the Kinnear Road Area Water Line Improvements Project; with the best responsive and responsible bidder, Korda/Nemeth Engineering, Inc., 1650 Watermark Drive, Suite 200, Columbus, Ohio 43215; in the amount of \$163,525.00; in accordance with the terms and conditions of the contract on file in the Office of the Division of Power and Water.

SECTION 2. That the City Auditor is hereby authorized to transfer \$163,525.00 within the Division of Power and Water, Dept/Div. No. 60-09, Water Works Enlargement Voted Bonds Fund, Fund No. 606, Object Level One 06, Object Level Three 6629, as follows:

Project No. | Project Name | OCA Code | change

690331-100000 (carryover) | HCWP Lagoon Sludge Rmvl | 606331 | -\$71,192.06
690473-100000 (carryover) | Misc. Booster Stations | 690473 | -\$67,908.14
690510-100000 (carryover) | HCWP Sludge Line | 606510 | -\$24,424.80
690236-100037 (carryover) | Kinnear Rd. W.L. Imp's | 623637 | +\$163,525.00

SECTION 3. That the 2010 Capital Improvements Budget is hereby amended as follows:

Fund No. | Project No. | Project Name | Current Authority | Revised Authority | change

690331-100000 (carryover) | HCWP Lagoon Sludge Rmvl | \$252,875 | \$181,682 | -\$71,193

690473-100000 (carryover) | Misc. Booster Stations | \$0 | \$67,909 | +\$67,909 (est. authority to match cancellation)

690473-100000 (carryover) | Misc. Booster Stations | \$67,909 | \$0 | -\$67,909

690510-100000 (carryover) | HCWP Sludge Line | \$24,425 | \$0 | -\$24,425

690236-100037 (carryover) | Kinnear Rd. W.L. Imp's | \$0 | \$163,525 | +\$163,525

SECTION 4. That the expenditure of \$163,525.00 is hereby authorized for the Kinnear Road Area Water Line Improvements Project within the Water Works Enlargement Voted Bonds Fund, Fund No. 606, Division 60-09, Project No. 690236-100037 (carryover), OCA Code 623637, Object Level Three 6629.

SECTION 5. That the City Auditor is authorized to make any accounting changes to revise the funding source for all contracts or contract modifications associated with this Ordinance.

SECTION 6. That the City Auditor is hereby authorized and directed to transfer any unencumbered balance in the project account to the unallocated balance within the same fund upon receipt of certification by the Director of the Department administering said project that the project has been completed and the monies no longer required for said project; except that no transfer shall be made from a project account by monies from more than one source.

SECTION 7. That the City Auditor is authorized to establish proper project accounting numbers as appropriate.

SECTION 8. That this Ordinance shall take effect and be in force from and after the earliest period allowed by law.

Legislation Number: 0050-2011

Drafting Date: 01/07/2011

Current Status: Passed

Version: 1

Matter Type: Ordinance

Explanation

This legislation authorizes the Finance and Management Director to establish a purchase order for the Division of Sewerage and Drainage, Sewer Maintenance Operations Center for one (1) Sewer Equipment Company of America (SECA) Easement Cleaning Machine with Trailer from Jack Doheny Supplies Ohio, Inc. The purchase of this equipment will be in accordance with the current State of Ohio State Term Schedule Contract (STS), Contract Number STS7767000406 which expires on March 31, 2011. Jack Doheny Supplies Ohio, Inc. is the sole distributor of SECA equipment in the State of Ohio [See Attached Letter To The State of Ohio]. The City of Columbus does not include this equipment on any Universal Term Contract and it is impractical to bid out beings that only one company will bid and cannot offer pricing any more or any less than what is being extended on the State Term Schedule contract. The equipment will be utilized at the Sewer Maintenance Operations Center for cleaning in areas that our current equipment cannot access. A copy of the State of Ohio contract is attached to this legislation. Waiver legislation in accordance with Section 329.27 of the Columbus City Code is being requested.

The funding requested on this legislation is based on a quoted dated November 17, 2010 and is the State of Ohio contract pricing. The quotation is on file with the Purchasing Office.

FISCAL IMPACT: \$45,017.10 is needed and budgeted for this purchase. This ordinance is contingent on the passage of the 2011 operating budget.

SUPPLIER: Jack Doheny Supplies Ohio, Inc. (38-3148955) Expires 8/17/12

The company is not debarred according to the Excluded Party Listing System of the Federal Government or prohibited from being awarded a contract according to the Auditor of State Unresolved Findings for Recovery Certified Search.

Title

To authorize the Director of Finance and Management to establish a purchase order for the purchase of one Easement Cleaning Machine with Trailer in accordance with a State of Ohio contract with Jack Doheny Supplies Ohio, Inc. for the Division of Sewerage and Drainage, to waive the provisions of competitive bidding and to authorize the expenditure of \$45,017.10 from the Sewerage System Operating Fund. (\$45,017.10)

Body

WHEREAS, the Division of Sewerage and Drainage wishes to purchase one (1) Easement Cleaning Machine with Trailer in accordance with the State of Ohio State Term Schedule Contract, STS7767000406 which expires on March 31, 2011, and

WHEREAS, Jack Doheny Supplies Ohio, Inc. is the sole distributor of equipment manufactured by Sewer Equipment Company of America (SECA) and holds said State Term Schedule Contract, and

WHEREAS, it is impractical to bid out beings that only one company will bid and cannot offer pricing any more or any less than what is being extended on the State Term Schedule contract, and

WHEREAS, the equipment will be used by crews at the Sewer Maintenance Operations Center for cleaning in areas that are inaccessible to current equipment, and

WHEREAS, the City of Columbus does not include this type of equipment on any Universal Term Contract, and

WHEREAS, this ordinance is being submitted in accordance with Section 329.27 of the Columbus City Code to waive the provisions of competitive bidding, and

WHEREAS, funding is based on a quote dated November 17, 2010 from Jack Doheny Supplies Ohio, Inc. and the quoted prices reflect State of Ohio contract pricing and is on file with the Purchasing Office; now, therefore

BE IT ORDAINED BY THE COUNCIL OF THE CITY OF COLUMBUS:

Section 1. That the Director of Finance and Management be and is hereby authorized and directed to establish a purchase order with Jack Doheny Supplies Ohio, Inc. for the purchase of one (1) Easement Cleaning Machine with Trailer for the Division of Sewerage and Drainage, in accordance with State of Ohio State Term Schedule Contract, STS7767000406 which expires on March 31, 2011.

Section 2. That the funding for this legislation is based on a quote dated November 17, 2010 from Jack Doheny Supplies Ohio, Inc. and the quoted prices reflect State of Ohio contract pricing, and is on file with the Purchasing Office.

Section 3. That the expenditure of \$45,017.10 or so much thereof as may be needed, be and the same hereby is authorized from the Sewerage System Operating Fund, Fund No. 650,

OCA: 604801
Object Level 1: 06
Object Level 03: 6651

Section 4. That this Council finds it to be in the best interest to waive the provisions of competitive bidding in accordance with Columbus City Code Section 329.27.

Section 5. That this Ordinance shall take effect and be in force from and after the earliest period allowed by law.

Legislation Number: 0069-2011

Drafting Date: 01/11/2011

Current Status: Passed

Version: 1

Matter Type: Ordinance

Explanation

The Department of Public Utilities, Division of Power and Water is required by Federal Energy Regulatory Commission (FERC) every 5 years to conduct Tabletop and Functional Exercises of the existing Emergency Action Plan (EAP) for O'Shaughnessy Dam. The Ohio Department of Natural Resources requires an EAP for Griggs and Hoover Dams as well. It is recommended that Griggs and Hoover Dams existing EAP's also be exercised on a periodic basis. To meet these requirements and recommendations an introductory Workshop and Tabletop Exercise of all three EAP's as well as a Functional Exercise of the O'Shaughnessy Dam EAP have been tentatively scheduled for June and August 2011 respectively. Planning for the workshop and exercises will be done in close coordination with the Franklin County Office of Emergency Management and Homeland Security (EMA). Exercises will be conducted at the EMA Emergency Operations Center.

Armada Ltd was previously selected, through a merit based process, by the Franklin County Office of Emergency Management and Homeland Security, to among other duties plan and conduct various exercises of Emergency Action Plans following established Federal Emergency Management Agency guidelines while working closely with various plan holders and EMA staff. At the recommendation of the EMA staff a proposal was solicited from Armada Ltd. for assistance in planning and conducting the above described EAP exercises. Armada's proposal was accepted by the Department of Public Utilities, Division of Power and Water in accordance with the same guidelines and utilizing the same fee schedule previously negotiated by Franklin County Office of Emergency Management and Homeland Security. The Department of Public Utilities, Division of Power and Water is requesting this City Council to waive the applicable competitive bidding requirement of the city code in order to facilitate this procurement.

Their federal identification number is 20-2900187.

FISCAL IMPACT: Funds are budgeted in the 2011 Division of Power and Water Operating Fund Budget to fund this purchase which totals \$33,400.00. This ordinance is contingent on the passage of the 2011 operating budget.

Title

To authorize the Director of Public Utilities to enter into contract with the Armada Ltd., to conduct an Introductory Workshop and Tabletop Exercise of the existing Emergency Action Plans (EAP's) for the Griggs, Hoover and O'Shaughnessy Dams as well as a Functional Exercise of the O'Shaughnessy Dam EAP as recommended by ODNR and required by FERC, for the Division of Power and Water; to waive competitive bidding provisions of section 329.06 of the Columbus City Code; and to authorize the expenditure of \$33,400.00. (\$33,400.00).

Body

WHEREAS, it is necessary for The Department of Public Utilities, Division of Power and Water, as recommended by ODNR and required by FERC to conduct an Introductory Workshop and Tabletop Exercise of the existing Emergency Action Plans (EAP's) for the Griggs, Hoover and O'Shaughnessy Dams as well as a Functional Exercise of the O'Shaughnessy Dam EAP, and

WHEREAS, it is necessary to waive section 329.06 of the competitive bidding provisions of the Columbus City Code; and

WHEREAS, it is necessary to authorize the Director of Public Utilities to enter into a Contract with the Armada Ltd., to Conduct an Introductory Workshop and Tabletop Exercise of the existing Emergency Action Plans (EAP's) for the Griggs, Hoover and O'Shaughnessy Dams as well as a Functional Exercise of the O'Shaughnessy Dam EAP as recommended by

ODNR and required by FERC for the above mentioned locations for the preservation of public health, peace, property and safety now, therefore,

BE IT ORDAINED BY THE COUNCIL OF THE CITY OF COLUMBUS

Section 1. That the Director of Public Utilities be and is hereby authorized to enter into a Contract with the Armada Ltd., to an Introductory Workshop and Tabletop Exercise of the existing Emergency Action Plans (EAP's) for the Griggs, Hoover and O'Shaughnessy Dams as well as a Functional Exercise of the O'Shaughnessy Dam EAP as recommended by ODNR and required by FERC.

Section 2. That City Council has determined that it is in the best interest of the City of Columbus that the formal competitive bidding requirements of Section 329.06 of the City Code be and are hereby waived for this workshop and tabletop exercise.

Section 3. That the expenditure of \$33,400.00. be and the same hereby is authorized from Water System Operating Fund 600, Department No. 60-09, OCA Code 602029, Object Level Three 3336 to cover the these services.

Section 4. That this ordinance shall take effect and be in force from and after the earliest period allowed by law.

Legislation Number: 0077-2011

Drafting Date: 01/11/2011

Current Status: Passed

Version: 1

Matter Type: Ordinance

Explanation

BACKGROUND:

This legislation authorizes the Director of the Department of Technology and the Director of the Department of Public Utilities (DPU) to renew an existing contract with VESOFT Inc. for software maintenance and support services, in the amount of \$925.00, with a coverage period of April 1, 2011 through September 30, 2011. This contract is associated with a legacy application that supports the generation of electric and water bills (including storm and sewer). Only six (6) months of support is required to allow sufficient time to completely retire the legacy system, which is being replaced by the Columbus Utility Billing System (CUBS).

It has been determined that VESOFT Inc. is the only provider of software maintenance and support for its software products licensed to the city. Therefore, this contract renewal is being established with the sole source provisions of the Columbus City Code, Section 329.07.

FISCAL IMPACT

During the past two (2) years (2009 and 2010) the Department of Technology, on behalf of DPU expended \$1,850.00 each year respectively for software maintenance and support services from VESOFT Inc. The 2011 contract renewal for software maintenance and support services with VESOFT Inc. for six (6) months in the amount of \$925.00, is budgeted and available in the 2011 Department of Technology internal service fund.

CONTRACT COMPLIANCE: 95-3788729 Expires: 01/03/2013

Title

To authorize the Director of the Department of Technology and the Director of Public Utilities to renew an existing contract with VESOFT Inc. for software maintenance and support services; in accordance with the sole source provisions of the Columbus City Code; and to authorize the expenditure of \$925.00 from the Department of Technology, Internal Services Fund. (\$925.00)

Body

WHEREAS, this legislation authorizes the Director of the Department of Technology and the Director of Public Utilities to renew an existing software maintenance and support services contract with VESOFT Inc. for six (6) months in the amount of \$925.00, with a term period of April 1, 2011 through September 30, 2011; to support the generation of electric and water bills, and

WHEREAS, this contract renewal is in accordance with the sole source provisions of the Columbus City Code, Section 329.07; and

WHEREAS, it is necessary to renew an existing software maintenance and support services contract with VESOFT Inc. to support the daily operation activities, thereby preserving the public health, peace, property, safety and welfare; now, therefore,

BE IT ORDAINED BY THE COUNCIL OF THE CITY OF COLUMBUS:

SECTION 1: That the Director of the Department of Technology and the Director of the Department of Public Utilities be and is hereby authorized to renew an existing software maintenance and support services contract with VESOFT Inc. for six (6) months, with a term period of April 1, 2011 through September 30, 2011, in the amount of \$925.00.

SECTION 2: That the expenditure of \$925.00 or so much thereof as may be necessary is hereby authorized to be expended from:

Div.: 47-01|**Fund:** 514|**Sub-fund:** 550|**OCA Code:** 514550|**Obj. Level 1:** 03|**Obj. Level 3:** 3369 |**Amount:** \$56.43
Div.: 47-01|**Fund:** 514|**Sub-fund:** 600|**OCA Code:** 514600|**Obj. Level 1:** 03|**Obj. Level 3:** 3369 |**Amount:** \$358.90
Div.: 47-01|**Fund:** 514|**Sub-fund:** 650|**OCA Code:** 514650|**Obj. Level 1:** 03|**Obj. Level 3:** 3369 |**Amount:** \$402.37
Div.: 47-01|**Fund:** 514|**Sub-fund:** 675|**OCA Code:** 514675|**Obj. Level 1:** 03|**Obj. Level 3:** 3369 |**Amount:** \$107.30

SECTION 3: That the City Auditor is authorized to make any changes to revise the funding source for any contract or contracts modifications associated with this ordinance.

SECTION 4: That this contract is being established in accordance with the sole source provisions of the Columbus City Code, Section 329.07.

SECTION 5: That this ordinance shall take effect and be in force from and after the earliest period allowed by law.

Legislation Number: 0079-2011

Drafting Date: 01/11/2011

Version: 1

Current Status: Passed

Matter Type: Ordinance

Explanation

BACKGROUND:

This legislation authorizes the Director of the Department of Technology (DoT), to renew an annual software license maintenance and support contract with B & L Associates for the BL/LIB Tape Library Management System and related software applications, in the amount of \$14,185.00, with a coverage period of April 1, 2011 through March 31, 2012. The

original contract (FP004153) was executed August 8, 2001. This contract renewal will allow the City of Columbus to continue receiving software license upgrades, support and related services for the BL/LIB Tape Library Management System.

The City of Columbus, Department of Technology (DoT) operates two (2) Unisys Mainframe Libra Systems that directly support mission critical applications. The Libra PR system supports the production Payroll system used by all city agencies and the Police Leads systems, which is used by the Police Department. The Unisys Libra DV system is used as a development system for the production applications running on the Libra PR system, as well as a fail over system. The Tape Library Management System is needed in order to meet City and State Record Retention polices, to avoid the interruption of services provided to city agencies, and to accomplish successful backups that are generated on different types of tape media. In addition, the system will ensure the continued operations of both Libra Systems, daily, weekly and monthly backups needed to be performed and maintained.

This ordinance also requests approval to continue services provided by B & L Associates Inc. in accordance with the sole source provisions of Section 329 of the Columbus City Code. As it has been determined that B & L Associates Inc. is the sole source supplier for software licenses, maintenance and support for the BL/LIB Software Product licensed to the City of Columbus; and the sole provider of the Tape Library Management System application that is specific to Unisys Mainframe Systems.

FISCAL IMPACT:

In 2009 and 2010, the Department of Technology expended \$14,185.00 (for each year) with B & L Associates Inc. for software license, maintenance and support services for the BL/LIB Tape Library Management System and related software applications. The 2011 cost for the annual software license, maintenance and support contract is \$14,185.00 bringing the aggregate contract total to \$133,054.35. This expenditure is budgeted and available in the Department of Technology, Information Services Division, internal service fund.

CONTRACT COMPLIANCE:

Vendor Name: B & L Associates Inc. CC#/FID#: 04-2572428 Expiration Date: 04/08/2012

Title

To authorize the Director of the Department of Technology (DoT) to renew an annual software license, maintenance and support contract with B & L Associates Inc. for the BL/LIB Tape Library Management System; in accordance with the sole source provisions of the Columbus City Code; and to authorize the expenditure of \$14,185.00 from the Department of Technology, Information Services Division, internal service fund. (\$14,185.00)

Body

WHEREAS, the Department of Technology (DoT), has a need to renew an annual software license, maintenance and support services contract with B & L Associates Inc. for the BL/LIB Tape Library Management System software application; and

WHEREAS, the cost associated with the 2011 B & L Associates Inc. contract renewal agreement is \$14,185.00, with a term period from April 1, 2011 through March 31, 2012; and

WHEREAS, this contract renewal is in accordance with the sole source provisions of the Columbus City Code, Section 329.07, and

WHEREAS, it is necessary to renew an annual software license, maintenance and support contract for the BL/LIB Tape Library Management System and related applications, with B & L Associates Inc., to ensure uninterrupted services, for the preservation of the public health, property, peace, safety, and welfare; now, therefore:

BE IT ORDAINED BY THE COUNCIL OF THE CITY OF COLUMBUS:

SECTION 1: That the Director of the Department of Technology is hereby authorized and directed to renew an annual software license, maintenance and support contract with B & L Associates Inc., for the BL/LIB Tape Library Management System and related applications in the amount of \$14,185.00, with a coverage period of April 1, 2011 through March 31, 2012.

SECTION 2: That the expenditure of \$14,185.00 or so much thereof as may be necessary is hereby authorized to be expended from:

Div.: 47-02|**Fund:** 514|**Sub-fund:** 001|**OCA Code:** 470202|**Obj. Level 1:** 03|**Obj. Level 3:** 3369 |**Amount:** \$14,185.00

SECTION 3: That the City Auditor is authorized to make any changes to revise the funding source for any contract or contract modifications associated with this ordinance.

SECTION 4: That this agreement is being established in accordance with the sole source provisions of the Columbus City Code, Section 329.07.

SECTION 5: That this ordinance shall take effect and be in force from and after the earliest period allowed by law.

Legislation Number: 0084-2011

Drafting Date: 01/12/2011

Version: 1

Current Status: Passed

Matter Type: Ordinance

Explanation

BACKGROUND:

This legislation authorizes the Director of the Department of Technology (DoT) to renew an annual software maintenance and support contract with Seachange International. The original agreement (ED025897) was entered into in 2006, however in 2010 ordinance 0720-2010, passed by Council November 15, 2010 allowed a one-time 15 month coverage term period so that the beginning term period starts in April instead of January. This ordinance will provide software upgrades, maintenance and support services for a 12 month period in the amount of \$12,960.00 for term period April 1, 2011 through March 31, 2012.

The Department of Technology requires technical support and hardware/software maintenance services from Seachange International to support ongoing operations of a Seachange Broadcast Media video server utilized by Media Services to play/air video files on the City's government and educational cable access channels. These maintenance and support services provided by Seachange International will allow the city to more effectively and efficiently operate the television access channels.

Seachange International is the sole proprietor and copyright holder of the Seachange Broadcast Media server. Accordingly, Seachange International is also the sole source of supply for upgrades, maintenance, support, new releases

and additional copies of this product. Therefore, this ordinance is being submitted in accordance with the Sole Source provisions of the Columbus City Code Section 329.07.

FISCAL IMPACT:

In years 2009 and 2010, the Department of Technology expended \$16,200.00 and \$12,960.00 respectively for hardware/software maintenance and support with Seachange International. The 2011 cost for the annual hardware/software maintenance and support contract is \$12,960.00. This expenditure is budgeted and available in the Department of Technology Information Services Division, Internal Services Fund.

CONTRACT COMPLIANCE:

Vendor Name: Seachange International FID/CC#: 04-3197974 Expiration Date: 10/13/2012

Title

To authorize the Director of the Department of Technology to renew an annual hardware/software maintenance and support contract with Seachange International, in accordance with the sole source provisions of the Columbus City Codes and to authorize the expenditure of \$12,960.00 from the Department of Technology, Information Services Division, Internal Services Fund. (\$12,960.00)

Body

WHEREAS, the Department of Technology (DoT) has a need to renew an annual contract for hardware/software maintenance and support services from Seachange International to support ongoing operations of a Seachange Broadcast Media server utilized by Media Services to play/air video files of the City's governmental and educational cable access channels (CTV); and

WHEREAS, the cost associated with the 2011 Seachange International contract is \$12,960.00, with the term period being April 1, 2011 through March 31, 2012; and

WHEREAS, this contract renewal is in accordance with the sole source provisions of the Columbus City Code, Section 329.07, and

WHEREAS, this ordinance is needed to continue receiving software upgrades, support and related services to support the daily operation activities, thereby preserving the public health, peace, property, safety and welfare; now, therefore:

BE IT ORDAINED BY THE COUNCIL OF THE CITY OF COLUMBUS:

SECTION 1: That the Director of the Department of Technology be and is hereby authorized to renew an annual hardware/software maintenance and support contract, with Seachange International in the amount of \$12,960.00, for the term period of April 1, 2011 through March 31, 2012.

SECTION 2: That the expenditure of \$12,960.00 or so much thereof as may be necessary is hereby authorized to be expended from:

Div.: 47-02|**Fund:** 514|**Sub-fund:** 001|**OCA Code:** 470202|**Obj. Level 1:** 03|**Obj. Level 3:** 3369 |**Amount:** \$12,960.00

SECTION 3: That the City Auditor is authorized to make any changes to revise the funding source for any contract or contract modifications associated with this ordinance.

SECTION 4: That this agreement is being established in accordance with the sole source provisions of the Columbus City Code, Section 329.07.

SECTION 5: That this ordinance shall take effect and be in force from and after the earliest period allowed by law.

Legislation Number: 0092-2011

Drafting Date: 01/12/2011

Current Status: Passed

Version: 1

Matter Type: Ordinance

Explanation**BACKGROUND:** This legislation authorizes the Director of Public Safety to modify and extend the current contract with Mount Carmel Occupational Health for testing services for the Division of Fire's Health and Physical Fitness Program. The Physical Health and Fitness program is a part of the current collective bargaining agreement between the City of Columbus and IAFF Local 67 Firefighters Union. The intent of the program is to ensure the overall general health and fitness of the fire fighters. This is the first of two (2) one-year extensions to this contract. The initial contract was for three years.

Contract Compliance: MCOH ~ 314379602-013 exp.

Emergency Designation: Emergency action is requested so that this testing service can continue uninterrupted pursuant to the collective bargaining contract between the City of Columbus and the IAFF Local 67 Firefighters Union.

FISCAL IMPACT: This ordinance authorizes an expenditure of \$750,000.00 from the General Fund for a contract with Mount Carmel Occupational Health for testing services for the Division of Fire Health and Physical Fitness Program. The Division of Fire budgeted \$822,240.00 in the General Fund operating budget for this contract in 2010. The division spent \$719,485.69 in 2010, and \$754,462.95 in 2009 for these services.

TitleTo authorize the Director of Public Safety to modify and extend the current contract with Mount Carmel Occupational Health for testing services for the Division of Fire's Health and Physical Fitness Program; to authorize the expenditure of \$750,000.00 from the General Fund; and to declare an emergency. (\$750,000.00)

Body**WHEREAS,** the City is required to provide Health and Physical Fitness Testing Services and related Education and Wellness Programs to the Division of Fire pursuant to the collective bargaining contract between the City and the International Association of Fire Fighters, Local 67; and

WHEREAS, it is in the City's best interest to extend the professional services contract with Mount Carmel Occupational Health to assist with the implementation of the Health and Physical Fitness Program for the Division of Fire; and

WHEREAS, an emergency exists in the usual daily operation of the Division of Fire, Department of Public Safety, in that it is immediately necessary to modify and extend the current contract with Mount Carmel Occupational Health, thereby preserving the public health, peace, property, safety and welfare; Now, therefore

BE IT ORDAINED BY THE COUNCIL OF THE CITY OF COLUMBUS

SECTION 1. That the Director of Public Safety is hereby authorized to modify and extend the current contract between the City and Mount Carmel Occupational Health to provide Health and Physical Fitness Testing Services and related Education and Wellness Programs for the Division of Fire.

SECTION 2. That the expenditure of \$750,000.00, or so much thereof as may be necessary, is hereby authorized to be expended from the General Fund 010, Department of Public Safety, Division of Fire 30-04, OCA 301499, OL3 Code 3336 to pay the cost thereof.

SECTION 3. That for the reasons stated in the preamble hereto, which is hereby made a part hereof, this ordinance is hereby declared to be an emergency measure and shall take effect and be in force from and after its passage and approval by the Mayor, or ten days after passage if the Mayor neither approves nor vetoes the same.

Legislation Number: 0097-2011

Drafting Date: 01/12/2011

Current Status: Passed

Version: 1

Matter Type: Ordinance

ExplanationBACKGROUND: There is a need to authorize the Director of Public Safety to enter into a contract with Medtronic Emergency Response Systems for the purchase of defibrillators and related equipment and operating supplies. The Fire Division employs these models of LifePak defibrillators/monitors/pacemakers on front line emergency response runs for cardiovascular emergencies.

Bid Information: Medtronic is the sole provider of this equipment.

Contract Compliance: 910697691, expiring 2/19/2012

Emergency Designation: Emergency legislation is requested so this important equipment can be purchased as soon as practical and be placed in service on EMS vehicles.

FISCAL IMPACT: This ordinance authorizes an expenditure of \$355,064.20 from the existing appropriation within the Safety Voted Bond Fund to authorize the Fire Division to enter into a contract with Medtronic Emergency Response Systems for the purchase of defibrillators and related equipment and operating supplies.

TitleTo authorize and direct the Director of Public Safety to enter into a contract with Medtronic Emergency Response Systems for the purchase of defibrillators and related equipment and operating supplies in accordance with sole source procurement provisions; to authorize the expenditure of \$355,064.20 from the Safety Voted Bond Fund; and to declare an emergency.(\$355,064.20)

Body**WHEREAS,** the Division of Fire carries Medtronic LifePak defibrillators/monitors/pacemakers on its Emergency Medical and first responder vehicles in order to assess and deal with cardiovascular emergencies; and

WHEREAS, this highly specialized and technical equipment requires service support, warranty work, and operating supplies as specified by and provided only by the manufacturer, Medtronic Emergency Response Systems; and

WHEREAS, this product support service has been provided in previous years solely by the manufacturer in order to adhere to warranty regulations and to insure that repairs were in accordance with the manufacturer's specifications; and

WHEREAS, for the aforementioned reasons, it is now necessary to enter into a contract with the manufacturer, Medtronic Emergency Response Systems, for the purchase of defibrillators and related equipment and operating supplies in accordance with sole source provisions of City Code; and

WHEREAS, an emergency exists in the usual daily operation of the Division of Fire, Department of Public Safety, in that it is immediately necessary to enter into a contract for the purchase of defibrillators and related equipment and operating supplies used on Emergency Medical vehicles, in accordance with the provisions of Section 329.07(c) the Columbus City Codes, thereby preserving the public health, peace, property, safety and welfare; Now, therefore,

BE IT ORDAINED BY THE COUNCIL OF THE CITY OF COLUMBUS:

SECTION 1. That the Director of Public Safety be and he is hereby authorized and directed to enter into a contract with Medtronic Emergency Response Systems for the purchase of defibrillators and related equipment and operating supplies.

SECTION 2. That this Council finds it is in the best interest of the City of Columbus that this expenditure be in accordance with the sole source provisions of Section 329.07(c), of the Columbus City Codes to permit the authorization

to enter into a contract with Medtronic Emergency Response Systems for LifePak equipment product support service and operating supplies for the Division of Fire.

SECTION 3. That the expenditure of \$355,064.20, or so much thereof as may be necessary, be and is hereby authorized from the Fire Division's Safety Bond Fund, Fund 701, Division of Fire No. 3004, Object Level One 06, Object Level Three 6652, OCA 713402, Project #340101-100002 Fire Apparatus Replacement-Medics.

SECTION 4. That the City Auditor is authorized to make any accounting changes to revise the funding source for all contract or contract modifications associated with this ordinance.

SECTION 5. That for the reasons stated in the preamble hereto, which is hereby made a part hereof, this ordinance is hereby declared to be an emergency measure and shall take effect and be in force from and after its passage and approval by the Mayor, or ten days after passage if the Mayor neither approves or vetoes the same.

Legislation Number: 0117-2011

Drafting Date: 01/14/2011

Current Status: Passed

Version: 1

Matter Type: Ordinance

Explanation

The purpose of this legislation is to authorize the Director of Finance and Management to establish purchase orders with Great Lakes Petroleum Company for the Division of Sewerage and Drainage to obtain Heating Oil in accordance with a cooperative purchasing contract competitively bid by the State of Ohio, GDC027E, Contract Number RS901110-3. Great Lakes Petroleum Company was awarded the contract for District 6 which includes Columbus.

This contract was bid specifically to be a cooperative contract for use by other governmental agencies in accordance with Chapter 1545 of the Ohio Revised Code (ORC). The State of Ohio contract expires April 30, 2012, the funding on this ordinance is for expenses that will occur in the winter months of 2011. The City of Columbus does not have a term contract for this product. Ordinance 582-87 authorizes the City of Columbus to participate in cooperative purchasing contracts and as a member of the Central Ohio Organization of Public Purchasers (CO-OPP), the City of Columbus is authorized to purchase from this contract. A copy of the State of Ohio contract is attached.

The Division of Sewerage and Drainage, Southerly Wastewater Treatment Plant and Jackson Pike Wastewater Treatment Plant require Heating Oil for boilers that heat the buildings throughout the plants. The Jackson Pike Wastewater Treatment Plant offsets some of the cost of heating by using naturally created methane.

Emergency legislation is being requested due to the fact that the Division of Sewerage and Drainage needs to order Heating Oil to allow for tanks to be filled without delay to keep the boilers in operation as the City experiences inclement weather.

SUPPLIER: Great Lakes Petroleum Co (34 -1850508) Expires 7-8-11

The company is not debarred according to the Excluded Party Listing System of the Federal Government or prohibited from being awarded a contract according to the Auditor of State Unresolved Findings for Recovery Certified Search.

FISCAL IMPACT: \$675,000.00 is required for this purchase. This ordinance is contingent on the passage of the 2011 operating budget.

\$575,000.00 was spent in 2009-2010 winter months

\$450,000.00 was spent in 2008-2009 winter months

Title

To authorize the Director of Finance and Management to establish Blanket Purchase Orders for Heating Oil from an established State of Ohio Cooperative Purchase Contract with Great Lakes Petroleum Company for the Division of Sewerage and Drainage, to authorize the expenditure of \$675,000.00 from the Sewerage System Operating Fund, and to declare an emergency. (\$675,000.00)

Body

WHEREAS, a Cooperative Purchasing Contract has been established with Great Lakes Petroleum Company, by the State of Ohio, GDC027E, Contract Number RS901110-3 for use by the State and other governmental entities that are members of the Central Ohio Organization of Public Purchasers (CO-OPP) for the option to purchase Heating Oil through April 30, 2012; and,

WHEREAS, the funding for this purchase will be for heating oil to be used during the 2011 winter months, and

WHEREAS, the Division of Sewerage and Drainage wishes to establish blanket purchase orders to heat buildings at the Southerly and Jackson Pike Wastewater Treatment Plants; and,

WHEREAS, an emergency exists in the usual daily operation of the Department of Public Utilities, in that it is immediately necessary to establish purchase orders from the aforementioned State contract for the purchase of heating oil to allow for tanks to be filled without delay to keep the boilers in operation as the City experiences inclement weather, for the immediate preservation of the public health, peace, property and safety; now, therefore

BE IT ORDAINED BY THE COUNCIL OF THE CITY OF COLUMBUS:

Section 1. That the Director of Finance and Management be and is hereby authorized to establish blanket purchase orders for the purchase of Heating Oil from a State of Ohio Cooperative Contract with Great Lakes Petroleum Company, for use by the Division of Sewerage and Drainage.

Section 2. That the expenditure of \$675,000.00 or so much thereof as may be needed, be and the same hereby is authorized from the Sewerage System Operating Fund, Fund No. 650,

Southerly Wastewater Treatment Plant

OCA 605055
Object Level: 2278.
Amount: \$525,000.00

Jackson Pike Wastewater Treatment Plant

OCA 605030
Object Level: 2278.
Amount: \$150,000.00

TOTAL: \$675,000.00

Section 3. That for the reasons stated in the preamble hereto, where is hereby made a part hereof, this ordinance is hereby declared to be an emergency measure, and shall take effect and be in force from and after its passage and approval by the Mayor, or ten days after passage if the Mayor neither approves nor vetoes the same.

Legislation Number: 0125-2011

Drafting Date: 01/14/2011

Current Status: Passed

Version: 2

Matter Type: Ordinance

Explanation

The Securities and Exchange Commission (SEC) has approved amendments to Rule 15c2-12, the municipal securities continuing disclosure rule. Effective December 1, 2010, the amendments affect event notice requirements and eliminate the exemption for certain variable rate demand obligations.

This ordinance amends Section 323.07 of the City Code to make it consistent with the changes to Rule 15c2-12. This ordinance is a result of collaboration between the City Attorney and the City's Bond Counsel.

The City Auditor asks for and recommends adoption of this ordinance.

Fiscal impact: none

Title

To amend Section 323.07 of the Columbus City Codes in order to comply with changes to SEC requirements relative to the disclosure of information on bonds and notes issued by the City.

Body

WHEREAS, the Securities and Exchange Commission (SEC) has approved amendments to Rule 15c2-12, the municipal securities continuing disclosure rule, effective December 1, 2010; and

WHEREAS, these amendments affect event notice requirements and eliminate the exemption for certain variable rate demand obligations; and

WHEREAS, it is necessary to amend Section 323.07 of the Columbus City Codes in order to make it compliant and consistent with Rule 15c2-12; now therefore

BE IT ORDAINED BY THE COUNCIL OF THE CITY OF COLUMBUS:

Section 1. That Section 323.07 of the Columbus City Codes, 1959, be and is hereby amended to read as follows:

323.07 - Disclosure of annual information and specified events.

(a) For purposes of and as used in this section, the following words shall have the following meanings:

- (1) "Accounting ~~principles~~Principles" means the accounting principles applied from time to time in the preparation of the annual general purpose financial statements of the city, initially being generally accepted accounting principles applicable to governments as promulgated by the Governmental Accounting Standards Board and as in effect from time to time.
- (2) "Annual ~~information~~Information" means for each fiscal year the annual financial information and operating data described in or pursuant to the ordinance relating to a particular series of ~~obligations~~Obligations. The ~~annual information~~Annual Information to be provided will be consistent with the financial information and operating data relating to the city and the series of ~~obligations~~Obligations included in the final official statement for those ~~obligations~~Obligations.

- (3) "Filing ~~date~~Date" with respect to any fiscal year means the 180th day following the end of that fiscal year (or, if that day is not a city business day, the next city business day).
- (4) "MSRB" means the Municipal Securities Rulemaking Board, or any legal successor thereto.
- (5) ~~"NRMSIR" means each nationally recognized municipal securities information repository designated from time to time by the SEC in accordance with the Rule.~~
- (5) ~~(6)~~"Obligated ~~person~~Person" shall have the meaning as provided in the Rule.
- (6) ~~(7)~~"Obligations" means bonds or notes of the city.
- (7) ~~(8)~~"Rule" means Rule 15c2-12 (See 17 CFR 240. 15c2-12) adopted by the SEC pursuant to the Securities Exchange Act of 1934, as amended from time to time.
- (8) ~~(9)~~"SEC" means the United States Securities and Exchange Commission, or any legal successor thereto.
- (10) ~~"SID" means the state information depository, if any, designated by the state (and, if applicable, recognized by the SEC).~~
- (9) ~~(11)~~"Specified ~~events~~Events" means any of the following, within the meaning of the Rule, with respect to each issue of ~~obligations~~Obligations:
- A. Principal and interest payment delinquencies;
 - B. ~~Nonpayment~~ **Non-payment** related defaults;
 - C. Unscheduled draws on debt service reserves reflecting financial difficulties;
 - D. Unscheduled draws on credit enhancements reflecting financial difficulties;
 - E. Substitution of credit or liquidity providers, or their failure to perform;
 - F. Adverse tax opinions ~~or~~, the issuance by the Internal Revenue Service of proposed or final determinations of taxability, Notices of Proposed Issue (IRS Form 5701-TEB), or other material notices or determinations with respect to the tax status of the Obligations, or other material events affecting the tax-exempt status of the obligations, status of the Obligations;
 - G. Modifications to rights of holders of the ~~obligations~~Obligations;
 - H. ~~Obligation calls~~; (i) Calls for redemption of the Obligations, other than calls pursuant to the mandatory redemption or the mandatory sinking fund provisions of the Obligations, if any, and (ii) tender offers;
 - I. Defeasances (of the applicable trust agreement entirely, or as to all or a portion of the ~~obligations~~Obligations only);
 - J. Release, substitution or sale of property securing repayment of the ~~obligations~~Obligations;
 ~~or~~
 - K. Rating changes;

L. Bankruptcy, insolvency, receivership or similar event of the city;

M. The consummation of a merger, consolidation, or acquisition involving the city or the or the sale of all or substantially all of the assets of the city, other than in the ordinary course of business, the entry into a definitive agreement to undertake such an action or the termination of a definitive agreement relating to any such actions, other than pursuant to its terms; or

N. Appointment of a successor or additional Trustee or the change of name of a Trustee.

For the purposes of subsection (L) above, the event is considered to occur when any of the following occur: the appointment of a receiver, fiscal agent or similar officer for the city in a proceeding under the U.S. Bankruptcy Code or in any other proceeding under Ohio or federal law in which a court or governmental authority has assumed jurisdiction over substantially all of the assets or business of the city, or if such jurisdiction has been assumed by leaving the existing governing body and officials or officers in possession but subject to the supervision and orders of a court or governmental authority, or the entry of an order confirming a plan of reorganization, arrangement or liquidation by a court or governmental authority having supervision or jurisdiction over substantially all of the assets or business of the city.

(10) "Trustee" means a trustee under any trust agreement that secures a series of obligations.

(b) The city shall provide, as stated below, to ~~each NRMSIR and to the SID~~MSRB:

- (1) Annual ~~information~~Information for each fiscal year ~~(beginning with the fiscal year ending December 31, 1996)~~ not later than the ~~filing date~~Filing Date for that fiscal year; and
- (2) When and if available, audited general purpose financial statements of the city for each fiscal year prepared in accordance with the ~~accounting principles~~Accounting Principles. The audited statements may be prepared and made available separately from the ~~annual information~~Annual Information.

The ~~annual information~~Annual Information may be provided by reference to other documents, such as the city's comprehensive annual financial report or subsequent final official statements relating to ~~obligations~~Obligations issued by the city, that may be provided to ~~each NRMSIR and to the SID~~MSRB. If reference is made to a subsequent official statement, the city shall file that official statement with the MSRB.

(c) The city shall provide to ~~each NRMSIR or to the MSRB and to the SID~~, all in a timely manner:

- (1) Notice of the occurrence of any ~~specified event if that specified event is material~~Specified Event; provided, however, that notice of the occurrence of the events listed in subsections (B), (G), (H) (i), (J), (M) and (N) of the definition of "Specified Event" contained in this section shall only be filed with the MSRB if such event is material. For the filing of a notice of the occurrence of any Specified Event, filing in a timely manner shall not be in excess of ten business days after the occurrence of such Specified Event.
- (2) Notice of a failure to comply with the requirements of paragraph (b) of this section.
- (3) Notice of the termination of the applicability of the requirements of this Section to a particular series of ~~obligations~~Obligations.
- (4) Notice of any material change in ~~accounting principles~~the Accounting Principles applied to the preparation of the annual audited financial statements of the city, or of any change in the city's fiscal year.

- (d) All documents provided to MSRB under this section shall be accompanied by identifying information as prescribed by the Municipal Securities Rulemaking Board.
- (e) The provisions of this section shall only apply to those Obligations that are subject to the disclosure requirements of the Rule as determined by the appropriate officers of the city upon the advice of bond counsel to the city. The proceedings for those Obligations subject to the disclosure requirements of the Rule shall require compliance with this section.
- (f) ~~(d)~~ The right of the holders or beneficial owners of ~~obligations~~Obligations to enforce any of the requirements of this section shall be limited, to the extent permitted by law, to an action for or specific performance to compel compliance by mandamus of the obligations and duties of the city under this section. Any failure of the city to comply with any of the provisions of this section shall not be or be deemed to be a failure, a default or an event of default under any ~~obligation~~Obligation or trust agreement relating to an ~~obligation~~Obligation.
- (g) ~~(e)~~ Notwithstanding any other provision of this section, the city may amend or waive any provision of this section if the city has received an opinion of counsel knowledgeable in federal securities laws to the effect that such amendment or waiver would not, in and of itself, cause the undertakings contained in this section to violate the ~~rule~~Rule if such amendment or waiver had been effective on the date of adoption of this section but taking into account any subsequent change in or official interpretation of the ~~rule~~Rule.
- (h) ~~(f)~~ The obligations of the city under this section for a series of ~~obligations~~Obligations shall remain in effect only for such period that ~~obligations~~Obligations of that series are outstanding in accordance with their terms and the city remains an ~~obligated person~~Obligated Person with respect to those ~~obligations~~Obligations.
- (i) ~~(g)~~ The city's undertakings pursuant to this section shall inure solely to the benefit of the holders and beneficial owners of the ~~obligations~~Obligations including book entry interest owners in them, and shall not create any rights in any other person.
- (j) ~~(h)~~ Unless specifically and expressly provided in a trust agreement or supplemental trust agreement relating to a series of ~~obligations~~Obligations, no ~~trustee~~Trustee shall be responsible for, or responsible for determining, compliance by the city with any of the agreements or obligations in or pursuant to this chapter.

Section 2. That existing Section 323.07 of the Columbus City Codes, 1959, is hereby repealed and replaced as provided in Section 1.

Section 3. That this ordinance shall take effect and be in force from and after the earliest date allowed by law.

Legislation Number: 0132-2011

Drafting Date: 01/18/2011

Version: 1

Current Status: Passed

Matter Type: Ordinance

Explanation

BACKGROUND:

This ordinance authorizes the Director of the Department of Technology and the Director of the Civil Service Commission, on behalf of the Civil Service Commission, to renew an annual maintenance, support and license agreement, with Governmentjobs.com (also known as NeoGov and previously known as Sigma Data Systems, Inc.), with a coverage period from 3/1/2011 through 12/31/2011. The 2011 renewal agreement is a ten month pro rated amount due to the tentative expiration of the Sigma Software Maintenance and Support (SSMS) program, which is currently only guaranteed to continue through 12/31/2011.

This renewal agreement is associated with Sigma AMS5 applicant management database system, a management database that provides applicant tracking information as it relates to vital intake, test administration, exam grades and certifications. This application provides printed letters or email notifications to applicants along with the ability to produce various statistical reports, along with allowing individuals to apply on-line for open recruitments and will maintain that data permanently in the Sigma database. Also, this application maintains the Commission's current on-line application process to allow for resume submission, self-service applicant employment profile updating, and electronic notification of exams and vacancies. In addition, Sigma AMS is currently used by the Division of Police in Recruiting to recruit and track potential Police Officer candidates.

In 1993, the original contract was established in accordance with the sole source procurement provisions, of Section 329 of the Columbus City Code. This ordinance is requesting the same sole source approval, as Governmentjobs.com is the sole provider of software compatible with the Civil Service Commission's current system.

EMERGENCY DESIGNATION:

Emergency designation is being requested to immediately facilitate prompt payment; to continue with services that are necessary to support daily operations; to ensure no service interruptions.

FISCAL IMPACT:

In 2009, \$7,600.00 was expended for the purchase of additional licenses and \$18,275.00 for license maintenance and support service agreement. In 2010, the Department of Technology legislated \$21,335.00 for the renewal of license maintenance and support services. This ordinance will provide \$17,828.00 for the 2011 renewal maintenance and support agreement, bringing the contract aggregate total to \$65,038.00. Funding for this ordinance has been identified and is available within the 2011 Department of Technology, agency direct charge budget , internal service fund.

CONTRACT COMPLIANCE:

Vendor Name: Governmentjobs.com CC #/FID #: 33 - 0888748 Expiration Date: 6/23/2012

Title

To authorize the Director of the Department of Technology and the Director of the Civil Service Commission, on behalf of the Civil Service Commission, to renew an existing agreement for maintenance, support and license from Governmentjobs.com; to authorize this ordinance in accordance with the sole source provisions of the Columbus City Codes; to authorize the expenditure of \$17,828.00 from the Department of Technology, internal service fund; and to declare an emergency. (\$17,828.00)

Body

WHEREAS, this ordinance authorizes the Director of Technology and the Director of the Civil Service Commission, on behalf of the Civil Service Commission, to renew an existing contract (associated with current purchase order ED038195) for maintenance and support from Governmentjobs.com (also known as NeoGov and previously known as Sigma Data Systems, Inc.); and

WHEREAS, this ordinance authorizes a pro rated ten month coverage period from 3/1/2011 through 12/31/2011 in the amount of \$17, 828.00, due to the tentative expiration of the Sigma Software Maintenance and Support (SSMS) program, which is currently only guaranteed to continue through 12/31/2011; and

WHEREAS, the additional Sigma 5 AMS PE end-user licenses will be part of an applicant management database system which provides applicant tracking information as it relates to vital intake, test administration, exam grades and certifications, among various other functions and features; and

WHEREAS, In 1993, the original contract was established in accordance with the sole source procurement provisions, of Section 329 of the Columbus City Code and this ordinance is requesting sole source approval, as Governmentjobs.com is the sole provider of software compatible with the Civil Service Commission's current system; and

WHEREAS, an emergency exists in the usual daily operation of the Department of Technology, in that it is immediately necessary to renew an annual software maintenance and support services agreement with Governmentjobs.com, to ensure uninterrupted services, for the preservation of the public health, property, peace, safety, and welfare; now, therefore:

BE IT ORDAINED BY THE COUNCIL OF THE CITY OF COLUMBUS:

SECTION 1: This ordinance authorizes the Director of the Department of Technology and the Director of the Civil Service Commission, to renew an existing contract for maintenance, support and license from Governmentjobs.com (also known as NeoGov and previously known as Sigma Data Systems, Inc.). This renewal agreement has a coverage period from 3/1/2011 through 12/31/2011, in the amount of 17,828.00.

SECTION 2: That the expenditure of \$17,828.00 or so much thereof as may be necessary is hereby authorized to be expended from:

Div: 47-01|**Fund:** 514 |**Subfund:**010|**OCA Code:** 270147|**Obj. Level One:** 03|**Obj. Level Three:** 3369|**Amount:** \$17,828.00

SECTION 3: That this agreement is in accordance with sole source procurement provisions of the Columbus City Codes Section 329.07.

SECTION 4: That the City Auditor is authorized to make any changes to revise the funding source for any contract or contract modifications associated with this ordinance.

SECTION 5: That for the reasons stated in the preamble hereto, which is hereby made a part hereof, this ordinance is hereby declared to be an emergency measure and shall take effect and be in force from and after its passage and approval by the Mayor, or ten days after passage if the Mayor neither approves nor vetoes the same.

Legislation Number: 0133-2011

Drafting Date: 01/18/2011

Current Status: Passed

Version: 1

Matter Type: Ordinance

Explanation

BACKGROUND: This ordinance authorizes the Finance and Management Director to renew a contract for the Facilities Management Division with Pad Door Systems for the emergency repair of various doors under the purview of the Facilities Management Division. This contract was originally bid by and awarded by the Facilities Management Division in 2007.

In 2010, the Purchasing Office awarded a Universal Term Contract (FL004728) to McKee Doors of Columbus for overhead door maintenance only. Because of better pricing, McKee Doors will serve as the primary vendor for the emergency repair of overhead doors for the Facilities Management Division. However, it is still necessary to set up a purchase order for entrance doors. That portion of the contract includes doors in buildings used by seven divisions and departments, as well as the Fire Training Academy. The overhead garage door portion is predominately for service doors at Fire Division facilities, as well as some overhead doors in five other divisions.

The original contract was formally bid and authorized by Ordinance No. 0193-2007, passed February 27, 2007, with four one-year renewal options. City Council has authorized three previous renewals. This is the fourth of four renewal options for the period of March 2, 2011 through February 28, 2012.

Fiscal Impact: The Facilities Management Division budgeted \$150,000.00 for door repair in the 2011 General Fund Budget. The cost of the Pad Door System contract in 2010 was \$77,629.96. The cost of the McKee Door Contract in 2010 was \$6,069.50. The cost of this renewal is \$30,000.00.

Pad Door Systems Contract Compliance No. 31-1546098; expiration date September 30, 2012.

Title

To authorize the Finance and Management Director to renew a contract for the Facilities Management Division with Pad Door Systems for the maintenance and repair of entrance doors and overhead doors; and to authorize the expenditure of \$30,000.00 from the General Fund. (\$30,000.00)

Body

WHEREAS, the original contract as formally bid and authorized by Ordinance No. 01937-2007, passed February 27, 2007; and

WHEREAS, it is necessary for the Facilities Management Division to renew a contract for the maintenance and repair of man doors and overhead doors; and

WHEREAS, there are four one-year renewal options and it is the recommendation of the Facilities Management Division to exercise the fourth of these renewals; now, therefore:

BE IT ORDAINED BY THE COUNCIL OF THE CITY OF COLUMBUS:

SECTION 1. That the Finance and Management Director is hereby authorized to renew a contract with Pad Door Systems for maintenance and repair of entrance doors and overhead doors for the Facilities Management Division.

SECTION 2. That the expenditure of \$30,000.00, or so much thereof that may be necessary in regard to the action authorized in SECTION 1, be and is hereby authorized and approved as follows:

Division: 45-07
Fund: 010
OCA Code: 450044
Object Level 1: 03
Object Level 3: 3370
Amount: \$30,000.00

SECTION 3. That this ordinance shall take effect and be in force from and after the earliest period allowed by law.

Legislation Number: 0134-2011

Drafting Date: 01/18/2011

Version: 1

Current Status: Passed

Matter Type: Ordinance

BACKGROUND: This Ordinance authorizes the Director of Public Utilities to modify and increase the Professional Construction Management Services agreement with URS Corporation - Ohio, which provides cost effective construction management, field representation, inspection testing, instrumentation/control design, integration and support services, and services for maintenance of operations during construction for various capital improvements projects for the Water Supply/Technical Support group, for the period of 2011 - 2015.

The original legislation, under Ordinance No. 1386-2010, stated that this agreement would be modified over the 2011 - 2015 period. The first contract was executed in December 2010 to allow the Professional Construction Management Team to perform a constructability review of the Upground Reservoir R-2 Project prior to advertisement for bid in December 2010.

This Modification (No. 1) will allow the Professional Construction Management Team to perform a constructability review of the Upground Reservoir Raw Water Pump Station and Raw Water Line projects prior to advertisement for bid which is slated for first quarter 2011. Additional tasks to be performed under this contract include the mobilization and initialization of the Professional Construction Management Program, which will include development of a Project Execution Plan (PXP) and establishment of the project Program Management and Information System (PMIS). Additional contracts for Professional Construction Management will include the South Wellfield CW-106 Project, the Hap Cremean Water Plant Treatment Improvements Project, and the Hap Cremean Water Plant Lagoon 3 Sludge Project. This modification will provide funding for services through second quarter 2011. An additional contract modification is anticipated in second quarter 2011 for services for the remainder of the year.

1.1 Amount of additional funds to be expended: \$1,625,000.00

Original Contract Amount:	\$ 200,000.00
Modification 1 (current)	<u>\$ 1,625,000.00</u>
Total (Orig. + Mod. 1)	\$ 1,825,000.00

1.2. Reasons additional goods/services could not be foreseen:

This modification was planned and identified in the original contracting legislation Ordinance No. 1386-2010.

1.3. Reason other procurement processes are not used:

The original Request for Proposals (RFP) anticipated a multi-year project with annual expenditures. The original authorizing legislation, Ordinance No. 1386-2010, identified the planned contract modifications.

1.4. How cost of modification was determined:

The Consultant prepared a cost breakdown exhibit including estimated hours and hourly rates for upcoming work. This cost breakdown was reviewed and approved by the Project manager for the City Division of Power and Water. Hourly rates and multipliers were submitted during the Request for Proposal phase of the project, with annual increases included for the contract duration.

This company is not debarred according to the Excluded Party Listing System of the Federal Government or prohibited from being awarded a contract according to the Auditor of State Unresolved Findings for Recovery Certified Search.

2. CONTRACT COMPLIANCE INFO: 34-0939859, expires 8/28/11, Majority

3. EMERGENCY DESIGNATION: It is requested that this Ordinance be handled in an emergency manner in order to allow for constructability reviews to be implemented prior to advertisement of the Upground Reservoir Raw Water Pump Station and Raw Water Line project, during first quarter 2011. This will allow any revisions to be incorporated into the bidding documents.

4. FISCAL IMPACT: A transfer of funds within the Water Build America Bonds Fund will be necessary, as well as an amendment to the 2010 Capital Improvements Budget.

Title

To authorize the Director of Public Utilities to modify and increase the agreement with URS Corporation - Ohio for

Professional Construction Management Services; for the Division of Power and Water; to authorize a transfer and expenditure of \$1,625,000.00 within the Water Build America Bonds Fund; to authorize an amendment to the 2010 Capital Improvements Budget; and to declare an emergency. (\$1,625,000.00)

Body

WHEREAS, Contract No. EL011123 was authorized by Ordinance No. 1386-2010, passed October 18, 2010, was executed November 24, 2010, and approved by the City Attorney on November 30, 2010; and

WHEREAS, modification #1 to the agreement is needed in order to provide necessary services for projects projected for first quarter 2011; and

WHEREAS, it is necessary for this Council to authorize the City Auditor to transfer and expend funds within the Water Build America Bonds Fund; and

WHEREAS, it is necessary to authorize an amendment to the 2010 Capital Improvements Budget for purposes of providing sufficient funding and expenditure authority for the aforementioned project expenditure; and

WHEREAS, an emergency exists in the usual daily operation of the Department of Public Utilities, Division of Power and Water, in that it is immediately necessary to authorize the Director of Public Utilities to modify and increase the agreement with URS Corporation - Ohio, for Professional Construction Management Services, in an emergency manner in order to allow revisions from constructability reviews to be incorporated into bid documents prior to advertisement during first quarter 2011, for the immediate preservation of the public health, peace, property, safety and welfare; now, therefore,

BE IT ORDAINED BY THE COUNCIL OF THE CITY OF COLUMBUS:

SECTION 1. That the Director of Public Utilities is hereby authorized and directed to modify and increase the agreement with URS Corporation - Ohio for Professional Construction Management Services, in the amount of \$1,625,000.00.

SECTION 2. That this contract modification is in compliance with Section 329.16 of Columbus City Codes, 1959.

SECTION 3. That the City Auditor is hereby authorized to transfer \$1,614,392.31 within the Department of Public Utilities, Division of Power and Water, Water Build America Bonds Fund, Fund No. 609, Dept./Div. No. 60-09, Object Level Three 6686, as follows:

Fund No. | Project No. | Project Name | OCA Code | Change

609		609999-100000 (carryover)		Unallocated Balance 609999		-\$309,981.53
609		690026-100000 (carryover)		Misc. Water Facilities 609026		-\$189,688.44
609		690236-100000 (carryover)		Water Main Rehab. 609236		-\$5,103.56
609		690236-100009 (carryover)		Cols. Coated Fabrics 623609		-\$871,814.51
609		690236-100030 (carryover)		Project No. 7 W.M. Imp's 623630		-\$23,000.00
609		690394-100000 (carryover)		Water Meter Renewal 609394		-\$2,836.50
609		690407-100000 (carryover)		Mound/Harrisburg Pike W.L. 609407		-\$130,000.00
609		690424-100000 (carryover)		Lazelle Rd. Storage Tank 609424		-\$81,967.77
609		690370-100000 (carryover)		Upground Res. (R2) 609370		+\$463,392.31
609		690370-100001 (carryover)		Upground Res. Pump Station 693701		+\$447,000.00
609		690370-100002 (carryover)		Upground Res. RWL 693702		+\$275,000.00
609		690359-100001 (carryover)		S. Wellfield Expansion 693591		+\$220,000.00
609		690331-100002 (carryover)		HCWP Lagoon 3 Sludge Rmvl. 693312		+\$95,000.00
609		690430-100001 (carryover)		HCWP Treatment Imp's 694301		+\$114,000.00

SECTION 4. That the 2010 Capital Improvements Budget is hereby amended as follows:

Fund No. | Proj. No. | Proj. Name | Current Authority | Revised Authority | Change

609 609999-100000 (carryover) Unallocated Balance \$309,982 \$0 -\$309,982
609 690026-100000 (carryover) Misc. Water Facilities \$189,688 \$189,689 +\$1 (establish authority to match cash)
609 690026-100000 (carryover) Misc. Water Facilities \$189,689 \$0 -\$189,689
609 690236-100000 (carryover) Water Main Rehab. \$705,604 \$710,707 +\$5,103 (establish authority to match cash)
609 690236-100000 (carryover) Water Main Rehab. \$710,707 \$705,603 -\$5,104
609 690236-100009 (carryover) Cols. Coated Fabrics \$0 \$871,815 +\$871,815 (establish authority to match cash)
609 690236-100009 (carryover) Cols. Coated Fabrics \$871,815 \$0 -\$871,815
609 690236-100030 (carryover) Project No. 7 W.M. Imp's \$200,000 \$177,000 -\$23,000
609 690394-100000 (carryover) Water Meter Renewal \$970,000 \$972,837 +\$2,837 (establish authority to match cash)
609 690394-100000 (carryover) Water Meter Renewal \$972,837 \$970,000 -\$2,837
609 690407-100000 (carryover) Mound/Harrisburg Pike W.L. \$130,000 \$260,000 +\$130,000 (establish authority to match cash)
609 690407-100000 (carryover) Mound/Harrisburg Pike W.L. \$260,000 \$130,000 -\$130,000
609 690424-100000 (carryover) Lazelle Rd. Storage Tank \$2,408,095 \$2,326,127 -\$81,968
609 690370-100000 (carryover) Upground Res. (R2) \$460,000 \$923,393 +\$463,393
609 690370-100001 (carryover) Upground Res. Pump Station \$0 \$447,000 +\$447,000
609 690370-100002 (carryover) Upground Res. RWL \$0 \$275,000 +\$275,000
609 690359-100001 (carryover) S. Wellfield Expansion \$0 \$220,000 +\$220,000
609 690331-100002 (carryover) HCWP Lagoon 3 Sludge Rmvl. \$0 \$95,000 +\$95,000
609 690430-100001 (carryover) HCWP Treatment Imp's \$0 \$114,000 +\$114,000

SECTION 5. That the expenditure of \$1,625,000.00 is hereby authorized for the Professional Construction Management Services Project within the Water Build America Bounds Fund, Fund No. 609, Division 60-09, Object Level Three 6686, Project Numbers, OCA Codes, and Amounts listed as follows:

<u>Project No.</u>	<u>Project Name</u>	<u>OCA</u>	<u>Amount</u>
690370-100000 (carryover)	Upground Reservoir (R2)	609370	\$ 474,000.00
690370-100001 (carryover)	Upground Res. Pump Station	693701	\$ 447,000.00
690370-100002 (carryover)	Upground Res. RWL	693702	\$ 275,000.00
690359-100001 (carryover)	S. Wellfield Expansion	693591	\$ 220,000.00
690331-100002 (carryover)	HCWP Lagoon 3 Sludge Rmvl.	693312	\$ 95,000.00
690430-100001 (carryover)	HCWP Treatment Imp's	694301	<u>\$ 114,000.00</u>
			\$1,625,000.00

SECTION 6. That the City Auditor is hereby authorized and directed to transfer any unencumbered balance in the project account to the unallocated balance within the same fund upon receipt of certification by the Director of the Department administering said project that the project has been completed and the monies no longer required for said project; except that no transfer shall be made from a project account by monies from more than one source.

SECTION 7. That the City Auditor is authorized to establish proper project accounting numbers as appropriate.

SECTION 8. That the City Auditor is authorized to make any accounting changes to revise the funding source for all contracts or contract modifications associated with this Ordinance.

SECTION 9. That for reasons stated in the preamble hereto, which is hereby made a part hereof, this Ordinance is declared to be an emergency measure and shall take effect and be in force from and after its passage and approval by the Mayor, or ten days after passage if the Mayor neither approves nor vetoes the same.

Legislation Number: 0145-2011

Drafting Date: 01/19/2011

Version: 1

Current Status: Passed

Matter Type: Ordinance

BACKGROUND: In May 2010, the Division of Police entered into contract under the provisions of sole source procurement with Helicopter Minit-Men for a one year maintenance agreement, including the option to renew for two, one-year terms. The contract expires February 28, 2011. It is now immediately necessary to authorize and direct the Director of Public Safety, Division of Police, to renew this contract for a second year with Helicopter Minit-Men, Inc. for the purpose of providing maintenance for the helicopters that the Division of Police operates.

Bid Information: n/a

Contract Compliance No: 31-0648665, expires April 6, 2012.

Emergency Designation: Emergency legislation is requested so that helicopter maintenance can continue uninterrupted.

FISCAL IMPACT: This ordinance authorizes an expenditure of \$562,010.00 from the General Fund for a helicopter maintenance contract. The Division of Police budgeted \$562,010.00 in the 2011 General Fund operating budget for this purpose. The Division of Police encumbered and/or expended \$562,010.00 for helicopter maintenance in 2010, \$540,292.00 for helicopter maintenance in 2009 and \$732,819.00 in 2008.

Title

To authorize and direct the Director of Public Safety to renew the contract for helicopter maintenance with Helicopter Minit-Men, Inc. for the Division of Police under the provisions of sole source procurement, to authorize the expenditure of \$562,010.00 from the General Fund; and to declare an emergency. (\$562,010.00)

Body

WHEREAS, the Director of Public Safety, Division of Police, has a need to renew this contract for a second year with Helicopter Minit-Men, Inc.; and

WHEREAS, Helicopter Minit-Men, Inc. is the sole company in this area that can provide this unique service; and

WHEREAS, an emergency exists in the usual daily operation of the Division of Police, Department of Public Safety, in that it is immediately necessary to renew the contract for helicopter maintenance so that repairs may continue thereby preserving the public peace, property, health, safety and welfare; now, therefore

BE IT ORDAINED BY THE COUNCIL OF THE CITY OF COLUMBUS:

SECTION 1. That the Director of Public Safety, be and is hereby authorized and directed to renew the contract for a second year with Helicopter Minit-Men, for helicopter maintenance for police helicopters for the Division of Police.

SECTION 2. That the expenditure of \$562,010.00, or so much thereof as may be needed, is hereby authorized as follows:

| DEPT 30-03 | FUND 010 | OBJ LEV 1 - 03 | OBJ LEV 3 - 3378 | OCA 300707 |

SECTION 3. That for the reasons stated in the preamble hereto, which is hereby made a part hereof, this ordinance is hereby declared an emergency measure and shall take effect and be in force from and after its passage and approval by the Mayor or ten days after passage if the Mayor neither approves nor vetoes the same.

Legislation Number: 0148-2011

Drafting Date: 01/20/2011

Version: 1

Current Status: Passed

Matter Type: Ordinance

Explanation

Janet Anderson Trustee, Janet Anderson, and Anderson Farms LTD, LLC, an Ohio limited liability company, collectively as the owner and grantor of approximately 22.8 +/- acres of real property, located in the vicinity of

Roberts Road and Alton-Darby Road, desire to donate the land to the City of Columbus, Ohio, Department of Recreation and Parks ("City") to be restored and preserved as parkland and an aquatic ecosystem resource. The City proposes to accept the property with additional environmental covenants necessary to restore and preserve its natural environment value, topography and wetlands pursuant to requirements the Ohio EPA associated with the Clover Groff Stream Restoration project. As a term of the conveyance, the City and Schottenstein Homes, LLC, an Ohio limited liability company, will enter into a Tax Agreement wherein Schottenstein Homes, LLC will be responsible for all tax liabilities associated with the property through the tax year of 2010. It has been determined by the Recreation and Parks Department to be in the City's best interest to accept the donated property. The following legislation authorizes acceptance of title to the donated real property on behalf of the City, and authorizes the Director of Recreation and Parks to execute those documents relating to the allocation of taxes for the property and the placing of additional restrictive/environmental covenants on the property in order preserve its natural environmental value.

Fiscal Impact: N/A

Emergency Justification: Emergency action is requested as not to delay the acceptance, restoration and preservation of the donated property's natural environment value an aquatic ecosystem resource.

Title

To accept 22.80 +/- acres of real property donated to the City of Columbus by Janet Anderson Trustee, Janet Anderson, and Anderson Farms LTD, LLC, an Ohio limited liability company, collectively; to authorize the Director of Recreation and Parks to execute an Agreement Regarding Real Estate Taxes with Schottenstein Homes, LLC, an Ohio Limited Liability Company; to place additional restrictive/environmental covenants on the property in order to preserve its natural environmental value; and to declare an emergency.

Body

WHEREAS, Janet Anderson Trustee, Janet Anderson, and Anderson Farms LTD, LLC, an Ohio limited liability company, collectively as the owner and grantor of approximately 22.8 +/- acres of real property, located in the vicinity of Roberts Road and Alton-Darby Road, desire to donate the land to the City of Columbus, Ohio, Department of Recreation and Parks ("City") to be restored and preserved as parkland and an aquatic ecosystem resource; and

WHEREAS, the City proposes to accept the property with additional environmental covenants necessary to restore and preserve its natural environment value, topography and wetlands pursuant to requirements the Ohio EPA associated with the Clover Groff Stream Restoration project; and

WHEREAS, as a term of the conveyance, the City and Schottenstein Homes, LLC, an Ohio limited liability company, will enter into a Tax Agreement, wherein Schottenstein Homes, LLC, will be responsible for all tax liabilities associated with the property through tax year 2010; and

WHEREAS, it has been determined by the Recreation and Parks Department to be in the City's best interest to accept the donated property; and

WHEREAS, an emergency exists in the usual daily operation of the City of Columbus, Ohio, in that it is immediately necessary to accept the donated real property, as fully described in the body of this legislation; to authorize the Director of the Department of Recreation and Parks to execute an Agreement regarding Real Estate Taxes between the City and the Schottenstein Homes, LLC, an Ohio limited liability company; and to authorize the Director of the Department of Recreation and Parks to place restrictive/environmental covenants on the accepted real property, as approved by the Department of Law, Real Estate Division, for the immediate preservation of the public health, peace, property and safety: **NOW, THEREFORE**

BE IT ORDAINED BY THE COUNCIL OF THE CITY OF COLUMBUS:

Section 1. That the Director of Recreations and Parks, on behalf of the City of Columbus, Ohio, hereby accepts the

following described real property, as donated to the City of Columbus, Ohio by Janet Anderson Trustee, Janet Anderson, and Anderson Farms LTD, LLC, an Ohio limited liability company, collectively, by a General Warranty deed substantially similar to the attached, to be used for parkland and conservation of an aquatic ecosystem resource:

*(SEE LEGAL DESCRIPTIONS ATTACHED HERETO
AS EXHIBIT "A" AND MADE A PART HEREOF)

Section 2. That the Director of the Department of Recreation and Parks be, and hereby is, authorized to execute those documents necessary to enter into an "Agreement Regarding Real Estate Taxes, with the Schottenstein Homes, LLC, an Ohio Limited Liability Company as prepared and/or approved by the Department of Law, Division of Real Estate, allocating the payment of real property taxes.

Section 3. That the Director of the Department of Recreation and Parks be and hereby is authorized to execute a Environmental Covenant and/or Restrictive Covenant, as approved by the Real Estate Division, Department of Law, by and between the City of Columbus, Ohio and the Ohio EPA, for that real property as described in "Section 1." of the body of this ordinance, located in Franklin County, State of Ohio, which was conveyed to the City of Columbus through Instrument Numbers 201101130007384 and 201101130007382, Recorder's Office, Franklin County, State of Ohio:

Section 4. That for the reasons stated in the preamble hereto, which is hereby made a part hereof, this ordinance is hereby declared to be an emergency measure and shall take effect and be in force from and after its passage and approval by the Mayor or 10 days after its passage if the Mayor neither approves nor vetoes the same.

Legislation Number: 0151-2011

Drafting Date: 01/21/2011

Current Status: Passed

Version: 1

Matter Type: Ordinance

Explanation

This ordinance authorizes the Finance and Management Director to renew a contract with Jani-King of Columbus for custodial services for the Fleet Management Division located at 4211 Groves Road. This contract was initially authorized by Ordinance 0531-2008, passed April 2, 2008 in the amount of \$55,401.53. This modification exercises the third of four one-year renewal options. The term of this contract will be April 1, 2011 to March 31, 2012. The contractor will pay a responsible wage and provide a health insurance benefit as required by Columbus City Codes 329.04 and 329.06.

Fiscal Impact: The Fleet Management Division budgeted \$27,549.00 for custodial services in 2011. The cost of this renewal is \$25,572.00. The initial cost of the contract in 2008 was \$55,401.53 due to the fact it the that contract included the purchase of various cleaning machines.

Jani-King of Columbus, contract compliance number is 31-1312402 expiration 02/26/2011.

Title

To authorize the Finance and Management Director to renew a contract with Jani-King of Columbus for custodial services at the Fleet Maintenance building at 4211 Groves Road and to authorize the expenditure of \$25,572.00 from the Fleet Management Services Fund.(\$25,572.00)

Body

WHEREAS, Ordinance 0531-2008 passed by City Council on April 2, 2008 authorized the Finance and Management Director to enter into contract with Jani-King Columbus for custodial services for the Fleet Management Division located at 4211 Groves Road; and

WHEREAS, the contract with Jani-King Columbus contains an option to renew the existing agreements for four one-year periods, and a third renewal is necessary; and now, therefore:

BE IT ORDAINED BY THE COUNCIL OF THE CITY OF COLUMBUS:

Section 1. That the Finance and Management Director is hereby authorized to renew a contract for the Fleet Management Division with Jani-King of Columbus for custodial services at the Fleet Maintenance building located at 4211 Groves Road from April 1, 2011 to March 31, 2012.

Section 2. That the expenditure of \$25,572.00 or so much thereof that may be necessary in regard to the action authorized in Section 1, be and is hereby authorized and approved as follows:

Division: 45-05
Fund: 513
OCA Code: 451206
Object Level 1:03
Object Level 3:3396
Amount: \$25,572.00

Section 3. That this ordinance shall take effect from and after the earliest period allowed by law.

Legislation Number: 0153-2011

Drafting Date: 01/21/2011

Current Status: Passed

Version: 1

Matter Type: Ordinance

ExplanationBACKGROUND: This legislation amends the 2010 Capital improvement budget and authorizes the transfer of \$200,000.00 between projects within the Safety Bond Fund for the purchase of outdoor warning sirens. This legislation also authorizes the Director of Public Safety to enter into an agreement with the Franklin County Emergency Management and Homeland Security agency (FCEMHS) for the purchase and installation of new electronic/radio-tone activated sirens and the replacement of sirens that are no longer serviceable or require extensive repairs. Under State of Ohio law, FCEMHS is the agency that has the responsibility to coordinate, operate and maintain the outdoor warning siren system within Franklin County. FCEMHS competitively bid their contracts with the assistance of the Franklin County Purchasing Department and complied with all basic laws pertaining to government contracting pursuant to the Ohio Revised Code, adjudicated case law, and Attorney General opinions concerning public contracts and competitive bidding. By entering into this agreement with FCEMHS, the City of Columbus will improve its portion of the outdoor warning siren system.

Emergency Designation: Emergency legislation is needed to expedite making the funds available to combine with purchases from other jurisdictions to obtain quantity discounts.

Bid Information: N/A.
Contract Compliance No: N/A

Fiscal Impact: The Department of Public Safety has determined that the expenditure for this purchase will come from existing Safety Bond Funds. Funds will be transferred from existing or completed projects to pay for expenses associated with the purchase and installations of approximately ten outdoor warning sirens. City Council Passed ordinance 0962-2007 in July of 2007 and ordinance 1541-2008 in October of 2008 for the total purchase of twenty-one new and replacement sirens.

TitleTo amend the Department of Public Safety's 2010 Capital Improvement Budget, to authorize the City Auditor to transfer funds between projects in the Safety Voted Bond Fund, to authorize the Director of The Department of Public Safety to enter into an agreement with the Franklin County Emergency Management and Homeland Security agency for the purchase and installation of the City of Columbus' portion of the outdoor warning siren system, to authorize the expenditure of \$200,000.00 from the Voted Public Safety Bond Fund, and to declare an emergency. (\$200,000.00)

Body**WHEREAS**, it is necessary to amend the Capital Improvement Budget and to transfer funds within the Safety Voted Bond Funds in order to purchase outdoor warning sirens; and

WHEREAS, the FCEMHS agency is responsible for managing the outdoor warning siren system within Franklin County not only by coordinating siren locations but also for their maintenance, relocation, replacement and activation; and

WHEREAS, the city of Columbus intends to improve its portion of the Emergency Management Agency outdoor warning siren system; and

WHEREAS, the Franklin County Emergency Management and Homeland Security agency has entered into competitively bid contracts for the necessary sirens, controls, installation and testing needed for improving the City of Columbus' portion of the outdoor warning siren system; and

WHEREAS, an emergency exists in the usual daily operation of the Department of Public Safety in that it is immediately necessary to enter into an agreement with the Franklin County Emergency Management and Homeland Security agency for the aforementioned purpose for the preservation of the public health, peace, property, safety, and welfare; Now, Therefore;

BE IT ORDAINED BY THE COUNCIL OF THE CITY OF COLUMBUS:

SECTION 1. That the 2010 Capital Improvement Budget is hereby amended as follows to account for various encumbrance cancellations in Fund 701:

<u>PROJECT</u>	<u>PROJECT NO</u>	<u>CURRENT CIB</u>	<u>REVISED CIB</u>
Police Facility Renovation-Lease (Carryover)	330023-100000	\$0.00	\$2,271.00
Neighborhood Policing Center (Carryover)	330024-100000	\$0.00	\$725.00
Fire Facility Renovation (Carryover)	340103-100000	\$183,590.00	\$201,169.00
Police Facility Renovation (Voted 2008)	330021-100000	\$1,254,515.00	
\$1,261,156.00			

SECTION 2. That the 2010 Capital Improvement budget is further amended as follows:

<u>PROJECT</u>	<u>PROJECT NO</u>	<u>CURRENT CIB</u>	<u>REVISED CIB</u>
Police Facility Renovation-Lease (Carryover)	330023-100000	\$2,271.00	\$0.00
Neighborhood Policing Center (Carryover)	330024-100000	\$725.00	\$0.00
Fire Facility Renovation (Carryover)	340103-100000	\$201,169.00	\$183,590.00
Police Facility Renovation (Voted 2008)	330021-100000	\$1,261,156.00	\$1,081,731.00
Sirens (Carryover)	310106-100000	\$362.00	\$20,575.00
Sirens (Voted 2008)	310106-100000	\$0.00	
\$179,425.00			

SECTION 3. That the City Auditor is hereby authorized and directed to transfer funds within the Safety Capital Improvement Fund as follows:

FROM:

Dept/Div: 30-03|Fund: 701|Project Number 330023-100000|Project Name - Police Facility Renovation-Lease |OCA Code 644476|Amount \$2,270.75

Dept/Div: 30-03|Fund: 701|Project Number 330024-100000|Project Name - Neighborhood Policing Center |OCA Code 330024|Amount \$724.29

Dept/Div: 30-03|Fund: 701|Project Number 340103-100000|Project Name - Fire Facility Renovation|OCA Code 644559|Amount \$17,578.63

Dept/Div: 30-03|Fund: 701|Project Number 330021-100000|Project Name - Police Facility Renovation |OCA Code 644476|Amount \$179,426.33

TO:

Dept/Div: 30-01|Fund: 701|Project Number 310106-100000|Project Name - Sirens|OCA Code 644518|Amount \$200,000.00

SECTION 4. That the Director of Public Safety be and is hereby authorized and directed to enter into an agreement with the Franklin County Emergency Management and Homeland Security for the purchase and installation of new electronic/radio-tone activated sirens and the removal from service of certain designated ones.

SECTION 5. That the expenditure of \$200,000 or so much thereof as may be necessary for said purpose, is hereby authorized from the Public Safety Bond fund as follows:

<u>Division</u>	<u>Fund.</u>	<u>OCA Code</u>	<u>Object Level 3</u>	<u>Project Name</u>	<u>Project No.</u>	<u>Amount</u>
30 - 01	701	644518	6644	Sirens	310106-100000	\$200,000

SECTION 6. That the City Auditor is authorized to make any accounting changes to revise the funding source for all contracts or contract modifications associated with this ordinance.

SECTION 7. That for the reasons stated in the preamble hereto, which is hereby made a part hereof, this ordinance is declared to be an emergency measure and shall take effect and be in force from and after its passage and approval by the Mayor, or ten days after passage if the Mayor neither approves nor vetoes the same.

Legislation Number: 0163-2011

Drafting Date: 01/24/2011

Current Status: Passed

Version: 1

Matter Type: Ordinance

Explanation

BACKGROUND: The Division of Police has been awarded a FY2010 Paul Coverdell Forensic Science Improvement Act grant. This is a federal grant program from the U.S. Department of Justice, Office of Justice Programs, National Institute of Justice. The City must be a sub grantee to the State of Ohio Office of Criminal Justice Services to participate in this program according to the federal grant guidelines. Therefore, the Mayor is required to sign a subgrantee award to accept this grant on behalf of the City. The official City contact authorized to act in connection with this grant is Crime Lab Manager, Jami St. Clair. The grant program provides funds to improve forensic crime lab activities. This award will fund training and travel costs for Columbus Police Department forensic lab personnel to attend new and/or updated forensic training, pay overtime costs for work on ballistics and drug analysis, and purchase a microscope with a digital camera for recording firearms evidence.

EMERGENCY DESIGNATION: Emergency legislation is needed to make the grant funds available as quickly as possible for upcoming training registration deadlines and to begin the purchasing process procedures. The grant award period started October 1, 2010.

FISCAL IMPACT: This ordinance authorizes the acceptance and appropriation of a grant in the amount of \$52,975.43 from the Federal government for training, overtime costs, and equipment for the City's Crime Lab. There will be no fiscal impact on the General Fund. All funds appropriated are reimbursable from the grant award.

Title

To authorize and direct the Mayor of the City of Columbus to accept a subgrantee award through the FY2010 Paul Coverdell National Forensic Science Improvement Act via the State of Ohio Office of Criminal Justice Services; to authorize Jami St. Clair, Crime Lab Manager, as the official city representative to act in connection with the subgrant; to authorize an appropriation of \$52,975.43 from the unappropriated balance of the General Government Grant Fund to the Division of Police to cover the costs of the subgrant project; and to declare an emergency (\$52,975.43).

Body

WHEREAS, the Division of Police was awarded funding through the FY2010 Paul Coverdell National Forensic Sciences Improvement Act for the training of forensic lab personnel, the purchase of minor equipment for the Crime Lab and funds for overtime costs on ballistics and drug analysis cases; and

WHEREAS, advancing technology and new Crime Lab employees have created a need for up to date and additional forensic science training, overtime funds and equipment for the Crime Lab; and

WHEREAS, Crime Lab Manager Jami St. Clair has been identified as the official representative to act in connection with this FY2010 Paul Coverdell National Forensic Science Improvement Act Subgrant and to provide information as required; and

WHEREAS, this ordinance is being submitted as an emergency measure because the grant funds need to be made available as quickly as possible so that personnel can register for training opportunities and begin the procedures for grant purchases during the grant award period which started October 1, 2010; and

WHEREAS, an emergency exists in the daily operation of the Public Safety Department, Division of Police, in that it is immediately necessary to authorize the Mayor to accept a FY2010 Paul Coverdell National Forensic Science Improvement Act Subgrant for the Division of Police Crime Lab and to authorize an appropriation for the grant activities for the immediate preservation of the public health, peace, property, safety and welfare; now, therefore

BE IT ORDAINED BY THE COUNCIL OF THE CITY OF COLUMBUS:

SECTION 1. That the Mayor of the City of Columbus be and is hereby authorized and directed to accept a FY2010 Paul Coverdell National Forensic Science Improvement Act Subgrant for specialized training, overtime funding, and minor equipment for the Columbus Police Crime Lab.

SECTION 2. That Crime Lab Manager Jami St. Clair is designated as the official program contact and authorized to act in connection with the FY2010 Paul Coverdell Forensic Sciences Improvement Act Grant Program, and to provide any additional information required.

SECTION 3. That from the unappropriated monies in the General Government Grant Fund and from all monies estimated to come into said fund from any and all sources and unappropriated for any other purposes during the subgrant award period the sum of \$52,975.43 is appropriated as follows:

DIV	FUND	OBJ LV#1	OBJ LV#3	OCA#	GRANT#	AMOUNT
3003	220	01	1102	331101	331101	\$24,227.97
3003	220	01	1121	331101	331101	2,180.00
3003	220	01	1160	331101	331101	3,392.00

3003	220	01	1171	331101	331101	351.00
3003	220	01	1173	331101	331101	727.00
3003	220	02	2206	331101	331101	1,762.46
3003	220	03	3330	331101	331101	16,735.00
3003	220	03	3331	331101	331101	3,600.00

SECTION 4. That the monies appropriated in the foregoing Section 3 shall be paid upon order of the Director of Public Safety; and that no order shall be drawn or money paid except by voucher, the form of which shall be approved by the City Auditor.

SECTION 5. That for reasons stated in the preamble hereto, which is hereby made a part hereof, this ordinance is hereby declared to be an emergency measure and shall take effect and be in force from and after its passage and approval by the Mayor or ten days after passage if the Mayor neither approves nor vetoes the same.

Legislation Number: 0166-2011

Drafting Date: 01/24/2011

Current Status: Passed

Version: 1

Matter Type: Ordinance

Explanation

BACKGROUND: The Franklin County Board of Commissioners has a need to continue the operation of a tuberculosis clinic for the detection, surveillance, and containment of tuberculosis. The Columbus Health Department has been awarded a grant from the Franklin County Board of Commissioners in the amount of \$1,200,000.00 for the continued operation of the Ben Franklin Tuberculosis Clinic. This grant is for the period through June 30, 2011.

Emergency action is requested to allow the financial transaction to be posted in the City's accounting system as soon as possible. Up to date financial posting promotes accurate accounting and financial management.

FISCAL IMPACT: This program is entirely funded by the Franklin County Board of Commissioners and is budgeted in the 2011 Health Department Grants Fund. This grant will not generate revenue or require a City match.

Title

To authorize and direct the Columbus Health Department to accept a grant from the Franklin County Board of Commissioners in the amount of \$1,200,000.00 for the continued operation of the Ben Franklin Tuberculosis Clinic; to authorize the appropriation of \$1,200,000.00 from the unappropriated balance of the Health Department Grants Fund, and to declare an emergency. (\$1,200,000.00)

Body

WHEREAS, \$1,200,000.00 in grant funds have been made available through the Franklin County Board of Commissioners for the continued operation of the Ben Franklin Tuberculosis Clinic at the Columbus Health Department; and,

WHEREAS, this ordinance is submitted as an emergency so as to allow the financial transaction to be posted in the City's accounting system as soon as possible. Up to date financial posting promotes accurate accounting and financial management; and,

WHEREAS, an emergency exists in the usual daily operation of the Columbus Health Department in that it is immediately necessary to accept this grant from the Franklin County Board of Commissioners and to appropriate these funds to the Health Department for the immediate preservation of the public health, peace, property, safety and welfare; Now, therefore,

BE IT ORDAINED BY THE COUNCIL OF THE CITY OF COLUMBUS:

SECTION 1. That the Columbus Health Department is hereby authorized and directed to accept a grant award of \$1,200,000.00 from the Franklin County Board of Commissioners for the operation of the Ben Franklin Tuberculosis Clinic through June 30, 2011.

SECTION 2. That from the monies in the Fund known as the Health Department Grants Fund, Fund No. 251, and from all monies estimated to come into said fund from any and all sources during the twelve months ending December 31, 2011, the sum of \$1,200,000 is hereby appropriated to the Health Department, Department No. 50-01, as follows:

Tuberculosis Prevention and Control/Elimination Grant:

OCA: 504055 Grant: 504055 Obj. Level 01:01 Amount: \$ 970,960
OCA: 504055 Grant: 504055 Obj. Level 01:02 Amount: \$ 42,500
OCA: 504055 Grant: 504055 Obj. Level 01:03 Amount: \$ 186,540

Total \$1,200,000

SECTION 3. That the monies appropriated in the foregoing Section 2 shall be paid upon the order of the Health Commissioner, and that no order shall be drawn or money paid except by voucher, the form of which shall be approved by the City Auditor.

SECTION 4. That for reasons stated in the preamble hereto, which is hereby made a part hereof, this ordinance is declared to be an emergency measure and shall take effect and be in force from and after its passage and approval by the Mayor, or ten days after passage if the Mayor neither approves nor vetoes the same.

Legislation Number: 0168-2011

Drafting Date: 01/24/2011

Current Status: Passed

Version: 1

Matter Type: Ordinance

Explanation1. BACKGROUND

The Department of Public Service, Division of Refuse Collection, provides Columbus residents with weekly yard waste collection through a contract with Rumpke of Ohio, Inc. This separate collection is necessary to segregate yard waste that can be composted and recycled from the regular waste stream; this serves to extend the life of the landfill operated by the Solid Waste Authority of Central Ohio (SWACO) and increases weekly refuse container capacity for residents. Landfill diversion requirements are established by Ohio Revised Code.

The city entered into contract for said services in 2010. This will be the second year of a 3-year contract with an estimated time frame of April 20, 2010 to March 31, 2013 and two 1-year renewal periods thereafter. This ordinance authorizes the Director of Public Service to modify the contract to increase the dollar amount for the second year of the 3-year term, with 2-1 year renewal options, and to authorize the expenditure of \$3,824,496.00 for the second year of service.

Street-side yard-waste collection service will be provided to approximately 227,000 households.

2. CONTRACT COMPLIANCE

Rumpke of Ohio, Incorporated's contract compliance number is 31-1617611; this expires January 25, 2012.

3. FISCAL IMPACT

The Division of Refuse Collection has a total of \$3,824,496.00 budgeted in the General Fund for yard-waste collection

services in 2011.

4. EMERGENCY DESIGNATION

Emergency action is requested to allow timely execution of this contract and to ensure an uninterrupted supply of service.

TitleTo authorize the Director of Public Service to execute a planned contract modification with Rumpke of Ohio, Inc., for yard-waste collection services; to authorize the expenditure of \$3,824,496.00 or so much thereof as may be needed from the General Fund for the second year of the contract, and to declare an emergency. (\$3,824,496.00)

Body**WHEREAS**, the Division of Refuse Collection provides Columbus residents with weekly collection of yard waste; and

WHEREAS, a 3-year contract with two 1-year renewal options was executed for this purpose; and

WHEREAS, the Division of Refuse Collection desires to continue the existing contract with Rumpke of Ohio Inc. to collection yard waste from City of Columbus residents through February 28, 2012; and

WHEREAS, this ordinance authorizes a planned modification to increase the dollar amount for the second year of the contract and expenditure of \$3,824,496.00 or so much thereof as may be necessary to pay for the expenses related to this contract for 2011; and

WHEREAS, an emergency exists in the usual daily operation of the Division of Refuse Collection in that it is immediately necessary to enter into a contract for this purpose to ensure an uninterrupted supply of service, thereby preserving the public health, peace, property, safety, and welfare; now, therefore,

BE IT ORDAINED BY THE COUNCIL OF THE CITY OF COLUMBUS:

SECTION 1. That the Director of Public Service be and hereby is authorized to continue the 3-year contract with two 1-year renewal options with Rumpke of Ohio, Inc., 107985 Hughes Road, Cincinnati, OH 45251 for yard waste collection service, and execute a planned modification to increase the contract amount for the second year of the contract at a cost of \$3,824,496.00 or so much thereof as may be needed.

SECTION 2. That for the purpose of paying the cost of the second year of said yard waste collection contract, the sum of \$3,824,496.00 or so much thereof as may be needed from Fund 010, the General Fund, Department No. 59-02, Division of Refuse Collection, Object Level One Code 03, Object Level Three Code 3373 and OCA Code 593566.

SECTION 3. That for the reason stated in the preamble here to, which is hereby made a part hereof, this ordinance is hereby declared to be an emergency measure and shall take effect and be in force from and after its passage and approval by the Mayor, or ten days after passage if the Mayor neither approves nor vetoes the same.

Legislation Number: 0169-2011

Drafting Date: 01/24/2011

Version: 1

Current Status: Passed

Matter Type: Ordinance

Explanation

BACKGROUND: The Columbus Health Department has been awarded a grant from the Ohio Department of Health. This ordinance is needed to accept and appropriate \$166,831.00 in grant money to fund the Dental Sealant Program.

The primary purpose of the Dental Sealant Program is to prevent dental caries among school children through an evidence-based community approach. The program targets higher-risk schools in order to reach higher-risk children. In addition to currently served second and third grade students, the program will be expanded to include sixth and seventh grade students along with additional second and third grade students.

This grant is for the period January 1, 2011 through December 31, 2011.

Emergency action is requested to allow the financial transaction to be posted in the City's accounting system as soon as possible. Up to date financial posting promotes accurate accounting and financial management.

FISCAL IMPACT: This program is entirely funded by the Ohio Department of Health. This grant will not generate revenue or require a City match.

Title

To authorize and direct the Columbus Health Department to accept a grant from the Ohio Department of Health in the amount of \$166,831.00 for the Dental Sealant Program; to authorize the appropriation of \$166,831.00 from the unappropriated balance of the Health Department Grants Fund; and to declare an emergency. (\$166,831.00)

Body

WHEREAS, \$166,831.00 in grant funds have been made available through the Ohio Department of Health for the Dental Sealant Program; and,

WHEREAS, this ordinance is submitted as an emergency so as to allow the financial transaction to be posted in the City's accounting system as soon as possible. Up to date financial posting promotes accurate accounting and financial management; and,

WHEREAS, an emergency exists in the usual daily operation of the Columbus Health Department in that it is immediately necessary to accept this grant from the Ohio Department of Health and to appropriate these funds to the Health Department for the immediate preservation of the public health, peace, property, safety and welfare; Now, therefore,

BE IT ORDAINED BY THE COUNCIL OF THE CITY OF COLUMBUS:

SECTION 1. That the Columbus Health Department is hereby authorized and directed to accept a grant award of \$166,831.00 from the Ohio Department of Health for the Dental Sealant Program for the period January 1, 2011 through December 31, 2011.

SECTION 2. That from the monies in the Fund known as the Health Department Grants Fund, Fund No. 251, and from all monies estimated to come into said fund from any and all sources during the 12 months ending December 31, 2011, the sum of \$166,831.00 is hereby appropriated to the Health Department, Department No. 50-01, as follows:

OCA: 501119; Grant No.: 501119; OL1:01; Amount: \$ 78,461
OCA: 501120; Grant No.: 501120; OL1:01; Amount: \$ 42,935
OCA: 501119; Grant No.: 501119; OL1:02; Amount: \$ 32,835
OCA: 501120; Grant No.: 501120; OL1:02; Amount: \$ 6,365
OCA: 501119; Grant No.: 501119; OL1:03; Amount: \$ 5,235
OCA: 501120; Grant No.: 501120; OL1:03; Amount: \$ 1,000

Total for Grant No. 501119	\$116,531
Total for Grant No. 501120	\$ 50,300

Total Grant Award	\$166,831
-------------------	-----------

SECTION 3. That the monies appropriated in the foregoing Section 2 shall be paid upon the order of the Health Commissioner, and that no order shall be drawn or money paid except by voucher, the form of which shall be approved by the City Auditor.

SECTION 4. That for reasons stated in the preamble hereto, which is hereby made a part hereof, this ordinance is

declared to be an emergency measure and shall take effect and be in force from and after its passage and approval by the Mayor, or ten days after passage if the Mayor neither approves nor vetoes the same.

Legislation Number: 0170-2011

Drafting Date: 01/24/2011

Current Status: Passed

Version: 1

Matter Type: Ordinance

Explanation

BACKGROUND: This ordinance authorizes the Finance and Management Director to enter into a contract with Statewide Emergency Products for the purchase of fifty-one (51) light bars and sirens to be installed on new police cruisers. Formal bids (SA003784) were received by the Purchasing Office on December 16, 2010 for the purchase of light bars and sirens for the Division of Police as follows:

Statewide Emergency Products, LLC (Majority)	\$67,779.00
On Duty Equipment (Female)	\$68,288.49
K. E. Rose Co. (Majority)	\$69,972.00
Public Safety Concepts, LLC (Majority)	\$68,850.00
D.R. Ebel Fire Equipment (Majority)	\$70,114.80
B&C Communications (Majority)	\$72,930.00
D & M Distributors Inc. (Majority)	\$73,440.00
Premier Safety & Service (Majority)	\$77,622.00

After review of the bids, the Division of Police recommends purchase of the light bars and sirens from Statewide Emergency Products as being the lowest and best bid.

This company is not debarred according to the Federal excluded parties listing or prohibited from being awarded a contract according to the Auditor of State unresolved findings for recovery certified search.

Contract Compliance: Statewide Emergency Products, 542105325 expires on 2/16/2012

Emergency Designation: Emergency action is necessary so that the purchase order for these items can be issued as soon as possible in order to install the light bars and sirens allowing the police cruisers to be on the street as soon as possible.

FISCAL IMPACT: This ordinance authorizes an appropriation and transfer of \$696,287, and an expenditure of \$67,779.00 in General Permanent Improvement Fund for the purchase of fifty-one (51) light bars and sirens for the Division of Police.

TitleTo appropriate and transfer \$696,287.00 within the General Permanent Improvement Fund; to authorize the Finance and Management Director to enter into a contract with Statewide Emergency Products for the purchase of light bars and sirens for the Division of Police; to authorize the expenditure of \$67,779.00 from the General Permanent Improvement Fund; and to declare an emergency. (\$67,779.00)

Body

WHEREAS, the Division of Police needs to purchase light bars and sirens to be installed on police cruisers; and

WHEREAS, funds are available for appropriation for this expenditure in the General Permanent Improvement Fund; and

WHEREAS, a formal advertisement for bid (SA003784) was opened on December 16, 2010; and

WHEREAS, Statewide Emergency Products submitted the lowest and most responsive bid; and

WHEREAS, an emergency exists in the usual daily operation of the Division of Police, Department of Public Safety, in that it is immediately necessary to authorize the Finance and Management Director to enter into a contract for the purchase of light bars and sirens for the Division of Police, thereby preserving the public peace, health, property, safety and welfare; now, therefore

BE IT ORDAINED BY THE COUNCIL OF THE CITY OF COLUMBUS:

SECTION 1. That the City Auditor is hereby authorized to appropriate \$696,287.00 within the unallocated balance of the General Permanent Improvement Fund ,748, Dept. No 45-01, Project 748999, OCA 643114, Object Level One- 06.

SECTION 2. That the appropriated funds be transferred within the General Permanent Improvement Fund, Fund 748 as follows:

From:

Dept 45-01: Project 748999: OCA 643114: Obj Lvl One- 06: Amount \$696,287.00

To:

Dept 30-03: Project 330035: OCA 748035: Obj Lvl One-06; Object Level Three 6651, Amount \$696,287.00

SECTION 3. That the Director of Finance and Management be and is hereby authorized to enter into a contract with Statewide Emergency Products for the purchase of fifty-one (51) light bars and sirens for the Division of Police in accordance with Solicitation SA003784.

SECTION 4. That the expenditure of \$67,779.00, or so much thereof as may be needed for the purchase of light bars and sirens, is hereby authorized from Dept/Div: 30-03, Fund 748, OCA 748035, Project 330035, Object Level One- 06, Object Level Three- 6651.

SECTION 5. That the City Auditor is authorized to make the necessary transfer between funds, and such funds are hereby appropriated, to carry out the purposes of this ordinance.

SECTION 6. That for the reasons stated in the preamble hereto, which is hereby made a part hereof, this ordinance is hereby declared to be an emergency measure and shall take effect and be in force from and after its passage and approval by the Mayor, or ten days after passage if the Mayor neither approves nor vetoes the same.

Legislation Number: 0171-2011

Drafting Date: 01/25/2011

Current Status: Passed

Version: 1

Matter Type: Ordinance

Explanation

BACKGROUND: This ordinance authorizes an appropriation of funds within the Special Purpose Fund for the Columbus Police Reserves. This appropriation will provide partial funding for costs associated with the operations of the Columbus Police Reserves Organization. Specifically, funds will be used for memberships, third party insurance, and uniform parts.

CONTRACT COMPLIANCE NO: N/A

EMERGENCY DESIGNATION: Emergency legislation is requested to ensure that reserve police officers have the

appropriate insurance coverage throughout the year and to avoid any lapses in coverage.

FISCAL IMPACT: This ordinance authorizes an appropriation of \$9,750.00 in the Special Purpose Fund for the Police Reserves Organization. All funds being appropriated are donations. There will be no effect on the financial status of the General Fund.

Title

To authorize an appropriation of \$9,750.00 from the unappropriated balance of the Special Purpose Fund to the Division of Police to provide partial funding for the costs associated with the Columbus Police Reserves Organization; and to declare an emergency. (\$9,750.00)

Body

WHEREAS, contributions have been made for the operations of the Columbus Police Reserves organization; and

WHEREAS, an appropriation is needed to cover costs associated with the Columbus Police Reserves Organization; and

WHEREAS, an emergency exists in the usual daily operation of the Division of Police, Department of Public Safety, in that it is immediately necessary to appropriate the aforementioned funds to ensure that reserve police officers have appropriate insurance coverage, thereby preserving the public health, peace, property, safety and welfare; now, therefore

BE IT ORDAINED BY THE COUNCIL OF THE CITY OF COLUMBUS:

SECTION 1. That from the unappropriated monies in the Special Purpose Fund, No. 223, and from all monies estimated to come into said fund from any and all sources and unappropriated for any other purpose during the fiscal year ending December 31, 2011, the sum of \$9,750.00 is appropriated to the Division of Police, as follows:

<u>DIV</u>	<u>OCA</u>	<u>SUB-FD</u>	<u>OBJ L #3</u>	<u>AMOUNT</u>
30-03	301218	026	2221	\$ 4,500.00
30-03	301218	026	2290	\$ 2,000.00
30-03	301218	026	3333	\$ 1,000.00
30-03	301218	026	3372	\$ 1,000.00
30-03	301218	026	3392	\$ 1,250.00
TOTAL				\$ 9,750.00

SECTION 2. That the monies appropriated in the foregoing Section 1 shall be paid upon order of the Public Safety Director; and that no order shall be drawn or money paid except by voucher, the form of which shall be approved by the City Auditor.

SECTION 3. That for the reasons stated in the preamble hereto, which is hereby made a part hereof, this ordinance is hereby declared to be an emergency measure and shall take effect and be in force from and after its passage and approval by the Mayor or ten days after passage if the Mayor neither approves nor vetoes the same.

Legislation Number: 0176-2011

Drafting Date: 01/26/2011

Version: 1

Current Status: Passed

Matter Type: Ordinance

Explanation1. BACKGROUND

The City of Columbus Department of Public Service was involved in the construction of an intersection improvement project at the intersection of Hudson Street and High Street in 2008 along with various other intersection projects. It was bid in mid 2008 and the intersection improvements have been constructed; however, acquisition of the final parcel of right-of-way needed for this project has not been completed. In early 2008 Zaheer Fuel, LLC (Parcel 5 WD, T) executed a purchase contract for the additional right-of-way needed from their site and the City Attorney's office requested a warrant for \$77,725.00 from the City Auditor's office. A warrant (Warrant 852607) was issued for the purchase of Parcel 5 and the City Attorney's office attempted to secure a "partial release of mortgage" from the mortgage company before completing the acquisition of the property.

The City's initial efforts to secure the necessary release were unsuccessful and after approximately 10 months, the Auditor's office requested the return of the Warrant with an assurance the funds would be placed back on the original acquisition Auditor's Certificate. In December of 2008, the Warrant was returned and the AC was credited with \$77,725.00. By October of 2009, the City had finally secured the partial release of mortgage but an IRS lien had been filed against the property. The property owner was unable to negotiate a payment arrangement with the IRS. In an effort to resolve the matter to the satisfaction of all of the parties, in June of 2010 the City Attorney's office filed an appropriation complaint but did not place the \$77,725.00 on deposit with the court. Several months later, once all of the parties to the lawsuit and the City had reached a settlement, the City Attorney's office again requested a warrant for the \$77,725.00. At that time it was determined the original hire and acquire AC had been accidentally canceled and that there were no funds available to pay the settlement. The following legislation authorizes the City Attorney's Office to complete the acquisition of Parcel 5 WD, T from Zaheer Fuel, LLC and to expend \$77,725.00 or so much thereof as may be necessary to acquire this parcel.

2. FISCAL IMPACT

Monies to pay for these costs are available within the Build America Bonds Fund.

3. EMERGENCY DESIGNATION

Emergency action is requested to allow the City Attorney's Office, Real Estate Division to complete this court ordered acquisition without additional delay these funds must be made available to the City Attorney's office as soon as possible.

TitleTo authorize the expenditure of \$77,725.00 or so much thereof as may be necessary to allow the City Attorney's Office, Real Estate Division, to complete the court ordered acquisition of Parcel 5 WD, T from Zaheer Fuel, LLC for the Hudson Street and High Street intersection improvements from the Build America Bonds Fund; to amend the 2010 C.I.B.; to authorize the transfer of monies within the Build America Bonds Fund; and to declare an emergency. (\$77,725.00)

Body

WHEREAS, in 2008 the City of Columbus ("Columbus") constructed an intersection improvement project at the corner of Hudson Street and High Street; and

WHEREAS, acquisition of the final parcel of right-of-way needed for this project has not been completed however; and

WHEREAS, in early 2008 Zaheer Fuel, LLC (Parcel 5 WD, T) executed a purchase contract for \$77,725.00 for the additional right-of-way needed from their site; and

WHEREAS, the City Attorney's office requested and received a warrant from the City Auditor's office for the purchase of Parcel 5; and

WHEREAS, the City Attorney's office needed a "partial release of mortgage" from the Parcel 5 mortgage company to complete the acquisition of this parcel; and

WHEREAS, because the City's efforts to secure the necessary release had been unsuccessful, after approximately 10 months the Auditor's office requested the return of the Warrant with an assurance the funds would be placed back on the original acquisition Auditor's Certificate; and

WHEREAS, in December of 2008 the Warrant was returned to the City Auditor and the Auditors Certificate was credited with \$77,725.00; and

WHEREAS, by October of 2009 the City had finally secured the partial release of mortgage but an IRS lien had been filed against the property; and

WHEREAS, the property owner was unable to negotiate a payment arrangement with the IRS; and

WHEREAS, in June of 2010, in an effort to resolve the matter to the satisfaction of all of the parties, the City Attorney's office filed an appropriation complaint with the Franklin County Court of Common Pleas but did not place the \$77,725.00 on deposit with the court; and

WHEREAS, once all of the parties to the lawsuit and the City had reached a settlement, the City Attorney's office again requested a warrant for the \$77,725.00; and

WHEREAS, at that time it was determined the original hire and acquire AC had been accidently canceled and that there were no funds available to pay the settlement; and

WHEREAS, the following legislation authorizes the City Attorney's Office to complete the acquisition of Parcel 5 WD, T from Zaheer Fuel, LLC and to expend \$77,725.00 or so much thereof as may be necessary to acquire this parcel; and

WHEREAS, an emergency exists in the usual daily operation of the Department of Public Service, Division of Design and Construction in that it is immediately necessary to authorize the City Attorney's office to complete acquisition of this parcel from Zaheer Fuel, LLC and to expend \$77,725.00 or so much thereof as may be necessary to complete this court ordered acquisition without additional delay thereby preserving the public health, peace, property, safety and welfare; now, therefore

BE IT ORDAINED BY THE COUNCIL OF THE CITY OF COLUMBUS:

SECTION 1. That the City Attorney's Office, Real Estate Division, be and is hereby authorized to complete acquisition of Parcel 5 WD, T from Zaheer Fuel, LLC.

SECTION 2. That the 2010 CIB authorized within ordinance 0564-2010 be amended to provide sufficient authority for this project as follows:

Fund / Project Number / Project / Current CIB Amount / amendment amount / CIB amount as amended
746 / 530282-100057 / Resurfacing - Resurfacing 2010 Project 6 / \$151,087.00 / (\$77,725.00) / \$73,362.00
746 / 530086-100019 / Miscellaneous Intersection Improvements - Hudson Street at High Street / \$0.00 / \$77,725.00 / \$77,725.00

SECTION 3. That the transfer of cash and appropriation be authorized as follows:

Transfer from:
Fund / project number / project / Object Level 01/03 Codes / OCA Code / Amount
746 / 530282-100057 / Resurfacing - Resurfacing 2010 Project 6 / 06-6600 / 768257 / \$77,725.00

Transfer to:
Fund / project number / project / Object Level 01/03 Codes / OCA Code / Amount
746 / 530086-100019 / Miscellaneous Intersection Improvements - Hudson Street at High Street / 06-6600 / 768604 / \$77,725.00

SECTION 4. That the City Attorney's Office, Real Estate Division, be and is hereby authorized to expend \$77,725.00, or so much thereof as may be necessary from the Build America Bonds Fund as follows: Project 530086-100019; Department/Division 59-12; Minor Object 6601; OCA Code 768604; to pay those costs relative to the court ordered acquisition of this parcel.

SECTION 5. That for the reasons stated in the preamble hereto, which is hereby made a part hereof, this ordinance is hereby declared to be an emergency measure and shall take effect and be in force from and after its passage and approval by the Mayor or ten days after passage if the Mayor neither approves nor vetoes the same.

Legislation Number: 0179-2011

Drafting Date: 01/26/2011

Current Status: Passed

Version: 1

Matter Type: Ordinance

ExplanationBids were opened by the Division of Purchasing on January 13, 2011 (#SA003799 Golf Course Chemicals).

An award was made for five items to:

Company	Amount	Contract Compliance #
Agrium Advanced Technologies	\$21,036.00	204910688 (exp. 3/08/12)

Principal Parties:

701 Kaderly Drive
Columbus, Ohio 43228

Local: Mike Sloma

(614)276-5103

204910688 (exp. 3/08/12)

Agrium has 510 employees in which seven have a Columbus address.

Verification was made for Agrium and found free of unresolved findings with the state as required by Ohio Revised Code (ORC) Section 9.24.

Benefits to Public:

These chemicals are used on the City's seven golf courses. Golf's chemical program protects and enhances the golf course/asset which is a major part of the experience a customer's greens fee is purchasing.

Emergency Justification:

In order to assure delivery of the chemicals by early spring of 2011, emergency legislation is requested.

Financial Impact (Completed and Initialed by Fiscal Section):

\$21,036.00

TitleTo authorize and direct the Finance and Management Director to enter into contract with Agrium Advanced Technologies for herbicides, fertilizers and pesticides for the Golf Division of the Recreation and Parks Department; to authorize the expenditure of \$21,036.00 from the Golf Operating Fund; and to declare an emergency. (\$21,036.00).

Body

WHEREAS, bids were solicited by the Purchasing Office and opened on January 13, 2011 and awards will be made for the purchase of golf course chemicals in accordance with the terms and conditions of #SA003799 on file in the Purchasing Office; and

WHEREAS, an emergency exists in the usual daily operation of the Recreation and Parks Department in that it is immediately necessary to enter into said purchase orders to ensure delivery of the products by early spring 2011; **NOW, THEREFORE**

BE IT ORDAINED BY THE COUNCIL OF THE CITY OF COLUMBUS:

Section 1. That the Finance and Management Director be and he is hereby authorized and directed to enter into a purchase order with Agrium Advanced Technologies for golf course chemicals for the Recreation and Parks Department, in accordance with specifications on file in the Purchasing Office.

Section 2. That the expenditure of \$21,036.00, or so much thereof as may be necessary, be and is hereby authorized from the Golf Course Operations Fund, as follows, to pay the cost thereof.

Fund 284; Dept. 51-03; Object Level 3-2209; OCA code 516005

Section 3. That the City Auditor is authorized to make any accounting changes to revise the funding source for all contracts or contract modifications associated with this legislation.

Section 4. That for the reasons stated in the preamble hereto, which is hereby made a part hereof, this ordinance is hereby declared to be an emergency measure and shall take effect and be in force from and after its passage and approval by the Mayor, or 10 days after passage if the Mayor neither approves nor vetoes the same.

Legislation Number: 0180-2011

Drafting Date: 01/26/2011

Current Status: Passed

Version: 1

Matter Type: Ordinance

Explanation

BACKGROUND: An appropriation of \$240,525.00 is needed from the unappropriated balance of the Federal and State Law Enforcement Contraband/Seizure Funds for the Division of Police. Funds were received from seized and forfeited property and must be used solely for law enforcement purposes as specified in Ordinance 1850-85. These funds are needed to purchase police bicycles, an Emergency Operation Center vehicle, hand held radars, and police retirement badges. Funds are also needed to cover the cost of some of the Division's travel and training needs and for refunds from claims.

CONTRACT COMPLIANCE NUMBER: N/A

EMERGENCY DESIGNATION: Emergency legislation is requested in order to appropriate the funds needed for travel and training that occur during the first three months of the year and to refund some court ordered claims.

FISCAL IMPACT: This ordinance authorizes and appropriation of \$240,525.00 in the Law Enforcement Contraband Seizure Fund for the purchase of various Police supplies, equipment, services, and claim refunds. There will be no effect on the financial status of the General Fund.

Title

To authorize an appropriation of \$240,525.00 from the unappropriated balance of the Law Enforcement Contraband Seizure Funds to purchase various law enforcement items, to fund travel and training needs and to refund monies for claims for the Division of Police, and to declare an emergency. (\$240,525.00)

Body

WHEREAS, monies were received from seized and forfeited property; and

WHEREAS, funds received from these forfeitures must be solely used for law enforcement purposes as specified in Ordinance #1850-85; and

WHEREAS, an emergency exists in the usual daily operation of the Division of Police, Department of Public Safety, in that it is immediately necessary to appropriate funds in the Law Enforcement Contraband Seizure Funds in order to provide funds for various law enforcement needs and refund claims, thereby preserving the public health, peace, property, safety and welfare; now, therefore

BE IT ORDAINED BY THE COUNCIL OF THE CITY OF COLUMBUS

SECTION 1. That from the unappropriated monies in the Law Enforcement Contraband Seizure Fund, Fund 219, and from all monies estimated to come into said fund from any and all sources and unappropriated for any other purpose during the fiscal year ending December 31, 2011 the sum of \$240,525.00 is appropriated to the Division of Police, #30-03, as follows:

OBJ LVL 1	OBJ LEVEL 3	OCA	SUBFUND	AMOUNT
02	2290	301838	002	\$ 91,780.00
05	5513	301838	002	10,000.00
02	2215	300988	016	38,745.00
02	2290	300988	016	10,000.00
03	3330	300988	016	30,000.00
03	3331	300988	016	20,000.00
06	6652	300988	016	<u>40,000.00</u>
TOTAL				\$240,525.00

SECTION 2. That the monies appropriated in the foregoing Section 1 shall be paid upon order of the Public Safety Director and that no order shall be drawn or money paid except by voucher, the form of which shall be approved by the City Auditor.

SECTION 3. That all funds necessary to carry out the purpose of this fund in 2011 are hereby deemed appropriated in an amount not to exceed the available cash balance in the fund.

SECTION 4. That for the reasons stated in the preamble hereto, which is hereby made a part hereof, this ordinance is hereby declared to be an emergency measure and shall take effect and be in force from and after its passage and approval by the Mayor, or ten days after passage if the Mayor neither approves nor vetoes the same.

Legislation Number: 0183-2011

Drafting Date: 01/27/2011

Current Status: Passed

Version: 1

Matter Type: Ordinance

Explanation Bids (#SA003799 Golf Course Chemicals) were opened by the Division of Purchasing on January 13, 2011. An award was made for 13 items to:

Company	Amount	Contract Compliance #
Helena Chemical Company	\$78,103.19	710293688 (exp. 11/03/12)

Principal Parties:

800 Distribution Drive
 Columbus, Ohio 43228
 Local: Chad Allen
 (614)604-2854

Helena Chemical Company has 25-49 employees of which one has a Columbus address.
 Contract Compliance - 710293688 (expires 11/03/2012)

Verification was made for Helena Chemical and found free of unresolved findings with the state as required by Ohio Revised Code (ORC) Section 9.24.

Benefits to Public:

These chemicals are used on the City's seven golf courses. Golf's chemical program protects and enhances the golf course/asset which is a major part of the experience a customer's greens fee is purchasing.

Emergency Justification:

In order to assure delivery of the chemicals by early spring of 2011, emergency legislation is requested.

Financial Impact:

\$78,103.19 from the Golf Operating Fund

TitleTo authorize and direct the Finance and Management Director to enter into contract with Helena Chemical Company for herbicides, fertilizers and pesticides for the Golf Division of the Recreation and Parks Department; to authorize the expenditure of \$78,103.19 from the Golf Operating Fund; and to declare an emergency. (\$78,103.19).

Body

WHEREAS, bids were solicited by the Purchasing Office and opened on January 13, 2011, awards will be made for the purchase of golf course chemicals in accordance with the terms and conditions of #SA003799 on file in the Purchasing Office; and

WHEREAS, an emergency exists in the usual daily operation of the Recreation and Parks Department in that it is immediately necessary to enter into said purchase orders to ensure delivery of the products by early spring 2011; **NOW, THEREFORE**

BE IT ORDAINED BY THE COUNCIL OF THE CITY OF COLUMBUS:

Section 1. That the Finance and Management Director be and he is hereby authorized and directed to enter into a purchase order with Helena Chemical Company for golf course chemicals for the Recreation and Parks Department, in accordance with specifications on file in the Purchasing Office.

Section 2. That the expenditure of \$78,103.19, or so much thereof as may be necessary, be and is hereby authorized from the Golf Course Operations Fund, as follows, to pay the cost thereof.

Fund 284; Dept. 51-03; Object Level 3-2209; OCA code 516005

Section 3. That the City Auditor is authorized to make any accounting changes to revise the funding source for all contracts or contract modifications associated with this legislation.

Section 4. That for the reasons stated in the preamble hereto, which is hereby made a part hereof, this ordinance is hereby declared to be an emergency measure and shall take effect and be in force from and after its passage and approval by the Mayor, or 10 days after passage if the Mayor neither approves nor vetoes the same.

Legislation Number: 0184-2011

Drafting Date: 01/27/2011

Current Status: Passed

Version: 1

Matter Type: Ordinance

ExplanationBids (#SA003799 Golf Course Chemicals) were opened by the Division of Purchasing on January 13, 2011. An award was made for four items to:

Company	Amount	Contract Compliance #
---------	--------	-----------------------

Trupointe Corporation \$31,430.99 800637648 (exp. 1-24-13)

Principal Parties:

Trupointe Corporation
2947 East 14th Avenue
Columbus, Ohio 43219
Local: Matt Saurine
(513)545-2076

Trupointe Corporation has 465 employees, none of which have a Columbus address. Contract Compliance # 800637648 (expires 1-24-2013)

Verification was made for Trupointe Corporation and found free of unresolved findings with the state as required by Ohio Revised Code (ORC) Section 9.24.

Benefits to Public:

These chemicals are used on the City's seven golf courses. Golf's chemical program protects and enhances the golf course/asset which is a major part of the experience a customer's greens fee is purchasing.

Emergency Justification:

In order to assure delivery of the chemicals by early spring of 2011, emergency legislation is requested.

Financial Impact:

\$31,430.99 from the Golf Operating Fund

Title To authorize and direct the Finance and Management Director to enter into contract with Trupointe Corporation for herbicides, fertilizers and pesticides for the Golf Division of the Recreation and Parks Department; to authorize the expenditure of \$31,430.99 from the Golf Operating Fund; and to declare an emergency. (\$31,430.99).

Body

WHEREAS, bids were solicited by the Purchasing Office and opened on January 13, 2011, awards will be made for the purchase of golf course chemicals in accordance with the terms and conditions of #SA003799 on file in the Purchasing Office; and

WHEREAS, an emergency exists in the usual daily operation of the Recreation and Parks Department in that it is immediately necessary to enter into said purchase orders to ensure delivery of the products by early spring 2011; **NOW, THEREFORE**

BE IT ORDAINED BY THE COUNCIL OF THE CITY OF COLUMBUS:

Section 1. That the Finance and Management Director be and he is hereby authorized and directed to enter into a purchase order with Trupointe Corporation for golf course chemicals for the Recreation and Parks Department, in accordance with specifications on file in the Purchasing Office.

Section 2. That the expenditure of \$31,430.99, or so much thereof as may be necessary, be and is hereby authorized from the Golf Course Operations Fund, as follows, to pay the cost thereof.

Fund 284; Dept. 51-03; Object Level 3-2209; OCA code 516005

Section 3. That the City Auditor is authorized to make any accounting changes to revise the funding source for all contracts or contract modifications associated with this legislation.

Section 4. That for the reasons stated in the preamble hereto, which is hereby made a part hereof, this ordinance is

hereby declared to be an emergency measure and shall take effect and be in force from and after its passage and approval by the Mayor, or 10 days after passage if the Mayor neither approves nor vetoes the same.

Legislation Number: 0185-2011

Drafting Date: 01/27/2011

Current Status: Passed

Version: 1

Matter Type: Ordinance

Explanation Background:

This ordinance will enable the Director of Recreation and Parks to accept a grant and enter into agreement with the Ohio Department of Natural Resources (ODNR) and provide for the appropriation of said funds to the Recreation and Parks Grant Fund. Funding has been awarded to construct the Alum Creek Trail from Innis Park to Easton. The funds will be used as part of the construction funding for the project. The target completion date for this project is December 2011.

A Clean Ohio Trails Fund grant for a .75 mile section of the Alum Creek Trail, Innis Park to Easton, was awarded to Recreation and Parks. This grant provides funds for construction to widen an existing eight-foot section to 10 feet, constructing a new path, one small bridge and one large bridge.

Financial Impact:

Total project cost estimated to be \$1 million dollars. The total grant amount from ODNR is \$485,000.00. The required local match will be provided from Recreation and Parks Capital Improvement Voted Bond Fund.

Emergency Justification:

This ordinance is submitted as an emergency to allow the financial transaction to be posted in the City's accounting system as soon as possible. Emergency action is also necessary to have funding available for necessary expenditures.

Title To authorize the Director of Recreation and Parks to accept a grant and enter into agreement with the Ohio Department of Natural Resources; to provide for the appropriation of said funds to the Recreation and Parks Grant Fund; and to declare an emergency. (\$485,000.00)

Body

WHEREAS, the State of Ohio, Ohio Department of Natural Resources, has awarded the City of Columbus, Recreation and Parks Department, a grant to assist with the improvements to the Alum Creek Bikeway; and

WHEREAS, The project will provide trail connectivity from Innis Park to Easton, and connect two major city parks and three neighborhoods to the regional trail network. The project will provide increased non-motorized transportation alternatives and health benefits related to walking and cycling; and

WHEREAS, an emergency exists in the usual daily operation of the Recreation and Parks Department in that it is immediately necessary to accept and appropriate said grant funds to comply with the terms of the grant for the preservation of public health, peace, property and safety; **NOW, THEREFORE**

BE IT ORDAINED BY THE COUNCIL OF THE CITY OF COLUMBUS:

SECTION 1. That the Director of Recreation and Parks be and he is hereby authorized and directed to accept a grant in the amount of \$485,000.00 and enter into an agreement with the State of Ohio, Ohio Department of Natural Resources for the purpose of improvements to the Alum Creek Bikeway.

SECTION 2. That from the unappropriated monies in the Recreation and Parks Grant Fund and from all monies estimated to come into said fund from any and all sources and unappropriated for any other purpose during the fiscal year ending December 31, 2011, the sum of \$485,000.00 is appropriated to the Recreation and Parks Department as follows:

Fund Type: Grant Fund; **Dept No.:** 51-01, **Fund No.:** 286; **OCA Code:** to be assigned by auditor; **Obj Level 3;** 6621; **Amount;** \$485,000.00, Grant No.; to be assigned by auditor

SECTION 3. That the monies in the foregoing Section 2 shall be paid upon order of the Director of Recreation and Parks, and that no order shall be drawn or money paid except by voucher, the form of which shall be approved by the City Auditor.

SECTION 4. That for the reasons stated in the preamble hereto, which is hereby made a part hereof, this ordinance is hereby declared to be an emergency measure and shall take effect and be in force from and after its passage and approval by the Mayor, or 10 days after passage if the Mayor neither approves nor vetoes the same.

Legislation Number: 0186-2011

Drafting Date: 01/28/2011

Current Status: Passed

Version: 1

Matter Type: Ordinance

Explanation1. **BACKGROUND**

This legislation authorizes the Director of the Department of Public Service to expend up to \$310,000.00 for utility relocation expenses in connection with the Parsons/Livingston Avenue improvement project.

Utility relocations performed by private utility companies were a necessary part of the work for this project and it is necessary to establish funding to pay for the relocation expenses incurred by these companies. This legislation authorizes payment for these utility relocation expenses in the amount of \$310,000.00.

The Department of Public Service, Division of Design and Construction is in the process of administering the subject project that will assist the private development initiative currently being undertaken by Nationwide Children's Hospital. The hospital's growth plans will retain and add significant job opportunities for the City of Columbus. The City's roadway improvement project is being constructed with American Recovery and Revitalization Act of 2009 funding.

The purpose of this public improvement project is to widen and improve Livingston Avenue from Ninth Street east to Ohio Avenue and to widen and improve Parsons Avenue from Jackson Street north to a point approximately 200 feet north of Kennedy Drive. This project includes full depth pavement replacement, installation of traffic medians and installation of upgraded tree lawns, street lighting, sidewalks and ADA compliant ramps.

2. FISCAL IMPACT

Funding for these utility relocations is budgeted and available within the 2010 C.I.B.

3. EMERGENCY DESIGNATION

Emergency action is requested to pay various utilities for invoices received at the earliest possible time to maintain proper accounting practices.

TitleTo authorize the appropriation and expenditure of \$310,000.00 or so much thereof as may be necessary for the payment of Utility Relocation expenses for various Utilities for the Parsons/Livingston Avenue Improvements project from the Fed-State Highway Engineering Fund; to amend the 2010 C.I.B.; to authorize the transfer of funds from the Build America Bonds Fund to the Fed-State Highway Engineering Fund; and to declare an emergency. (\$310,000.00)

Body**WHEREAS**, the City of Columbus, Department of Public Service, Division of Design and Construction, is engaged in the Arterial Street Rehabilitation - Parsons/Livingston Avenue Improvements project; and

WHEREAS, the purpose of this project is to widen and improve Livingston Avenue from Ninth Street east to Ohio Avenue and to widen and improve Parsons Avenue from Jackson Street north to a point approximately 200 feet north of Kennedy Drive; and

WHEREAS, improvements contemplated by this project include full depth pavement replacement, installation of traffic medians and installation of upgraded tree lawns, street lighting, sidewalks and ADA compliant ramps; and

WHEREAS, as part of this project it was necessary for various utilities to relocate their facilities and it is necessary to provide for payment of these expenses; and

WHEREAS, this legislation authorizes the Director of Public Service to make payment to these utilities for the above described expenses; and

WHEREAS, an emergency exists in the usual daily operation of the Department of Public Service, Division of Design and Construction in that it is immediately necessary to authorize the expenditure of these funds to provide payment to these utilities at the earliest possible time for invoices received and to maintain proper accounting thereby preserving the public health, peace, property, safety and welfare; now, therefore

BE IT ORDAINED BY THE COUNCIL OF THE CITY OF COLUMBUS:

SECTION 1. That the Director of the Department of Public Service, be and is hereby authorized to expend \$310,000.00, or so much thereof as may be necessary from the Fed-State Highway Engineering Fund to pay various other utilities for utility relocation work performed in connection with the Arterial Street Rehabilitation - Parsons/Livingston Avenue Improvements Project as follows.

Division of Design and Construction, Dept-Div 59-12

Fund / Project No. / Project / O.L. 03 Codes / OCA Code / Amount

765 / 598091-200000 / Parsons/Livingston / 06-6631 / 598091 / \$310,000.00

SECTION 2. That the Transfer of cash and appropriation within and between the following funds be authorized as follows:

Transfer from:

Fund / Project / Project Name / O.L. 01-03 Codes / OCA / Amount

746 / 530103-100035 / Arterial Street Rehabilitation - Parsons/Livingston / 06-6600 / 760335 / \$310,000.00

Transfer to:

Fund / Project / Project Name / O.L. 01-03 Codes / OCA / Amount

746 / 530103-100035 / Arterial Street Rehabilitation - Parsons/Livingston / 10-5501 / 760335 / \$310,000.00

SECTION 3. That the Transfer of monies between the following funds be authorized as follows:

Transfer from:

Fund / Project / Project Name / O.L. 01-03 Codes / OCA / Amount

746 / 530103-100035 / Arterial Street Rehabilitation - Parsons/Livingston / 10-5501 / 760335 / \$310,000.00

Transfer To:

Fund / Grant / Grant Name / O.L. 01-03 Codes / OCA / Amount

765 / 598091-200000 / Parsons/Livingston / 80-0886 / 598091 / \$310,000.00

SECTION 4. That the sum of \$310,000.00 be and hereby is appropriated from the unappropriated balance of Fund 765, the Federal-State Highway Engineering Fund, and from all monies estimated to come into said funds from any and all sources and unappropriated for any other purpose during the fiscal year ending December 31, 2010 as follows:

Fund / Grant / Grant Name / O.L. 01-03 Codes / OCA / Amount

765 / 598091-200000 / Parsons/Livingston / 06-6600 / 598091 / \$310,000.00

SECTION 5. That the monies appropriated in the foregoing Section 6 shall be paid upon order of the Director of Public

Service and that no order shall be drawn or money paid except by voucher, the form of which shall be approved by the City Auditor.

SECTION 6. That for the reasons stated in the preamble hereto, which is hereby made a part hereof, this ordinance is hereby declared to be an emergency measure and shall take effect and be in force from and after its passage and approval by the Mayor or ten days after passage if the Mayor neither approves nor vetoes the same.

Legislation Number: 0187-2011

Drafting Date: 01/28/2011

Current Status: Passed

Version: 1

Matter Type: Ordinance

Explanation1. BACKGROUND

The Division of Refuse Collection solicits various services to maintain property and equipment used daily in the operation.

The Division of Refuse Collection advertised and solicited competitive bids for Alarm Maintenance; Fuel Dispenser Service and Maintenance; Fuel Tank Testing, Reporting, and Maintenance; Forklift Service and Maintenance; and Fire Extinguisher Service and Replacement in accordance with Section 329.06 and opened them on various dates.

<u>Service Contract</u>	<u>Vendor</u>	<u>2011 Amount</u>	<u>Reference Documents</u>
Alarm System Maintenance	Elite Protection Services	\$1,200.00	SO036009- 12/8/2010
Fuel Dispenser Service	C H Bradshaw Co. Inc.	\$2,000.00	SO033412-2/19/2010
Fuel Tank Maintenance	Advanced Fuel Systems Inc.	\$4,000.00	SO033882-4/7/2010
Fork Lift Maintenance	MH Logistics Corp	\$2,500.00	SO030774-2/13/2009
Fire Extinguisher Service	Silco Fire Protection Co.	\$6,000.00	SO034630-7/9/2010

The terms of the original contracts are through February 28, 2010 and February 28, 2011, with the option to extend the contracts up to two (2) additional years. The Division and respective Vendors have agreed to extend the contracts for the one additional year, through and including February 29, 2012.

This legislation authorizes the Director of Public Service to modify these agreements with aforementioned Vendors by extending the contracts through and including February 29, 2012, modifying the agreements to provide for additional maintenance, and increasing the amount of the contracts to a total amount not to exceed of \$15,700.00.

Emergency action is requested to ensure an uninterrupted supply of service.

2. CONTRACT COMPLIANCE

Elite Protection Services' contract compliance number is 26-2691070; and it expires on August 23, 2012.
C H Bradshaw Company Inc.'s contract compliance number is 31-0989631; and it expires on November 17, 2012.
Advanced Fuel Systems' contract compliance number is 31-1622985; and it expires on May 3, 2012.
MH Logistics Corp's contract compliance number is 37-1401792; and it expires on December 10, 2011.
Silco Fire Protection Co.'s contract compliance number is 31-0620191; and it expires on October 13, 2011.

3. FISCAL IMPACT

The Division of Refuse Collection's total estimated expenditure for the said term of these contracts is \$15,700.00. Funds are budgeted and available for this service in the Division of Refuse Collection's 2011 General Fund budget.

4. EMERGENCY DESIGNATION

Emergency action is requested to allow timely execution of this contract and to ensure an uninterrupted supply of service.

TitleTo authorize the Director of Public Service to modify and extend various maintenance contracts with Elite Protection Services, CH Bradshaw Company Inc., Advanced Fuel Systems, MH Logistics Corp., and Silco Fire Protection Co.; to authorize the expenditure of \$15,700.00 from the General Fund and to declare an emergency. (\$15,700.00)

BodyWHEREAS, the Division of Refuse Collection advertised and solicited informal formal bids for various maintenance contracts with the options of extension and selected the lowest, responsive, responsible and best bid; and

WHEREAS, these services are used to keep the Division of Refuse Collection's property and equipment in working order; and

WHEREAS, the Division of Refuse Collection desires to modify and extend existing contracts for Alarm Maintenance; Fuel Dispenser Service and Maintenance; Fuel Tank Testing, Reporting, and Maintenance; Forklift Service and Maintenance; and Fire Extinguisher Service and Replacement with Elite Protection Services, CH Bradshaw Company Inc., Advanced Fuel Systems, MH Logistics Corp., and Silco Fire Protection Co. through February 29, 2012; and

WHEREAS, an emergency exists in the usual daily operation of the Division of Refuse Collection in that it is immediately necessary to enter into a contract for maintenance services to ensure an uninterrupted supply of service, thereby preserving the public health, peace, property, safety, and welfare; now, therefore,

BE IT ORDAINED BY THE COUNCIL OF THE CITY OF COLUMBUS:

SECTION 1. That the Director of Public Service be and hereby is authorized to modify and extend the agreements with Elite Protection Services, CH Bradshaw Company Inc., Advanced Fuel Systems, MH Logistics Corp., and Silco Fire Protection Co. or their designee relative to the Division of Refuse Collection.

Elite Protection Services
1215 Polaris Pkwy #217
Columbus, OH 43240

CH Bradshaw Company Inc.
2004 Hendrix Drive
Grove City, OH 43123

Advanced Fuel Systems
841 Alton Avenue
Columbus, OH 43219

MH Logistics Corp.
2055 Hardy Parkway
Grove City, OH 43123

Silco Fire Protection Co.
1425 Universal Drive
Columbus, OH 43207

SECTION 2. That for the purpose of paying for Alarm Maintenance; Fuel Dispenser Service and Maintenance; Fuel Tank Testing, Reporting, and Maintenance; Forklift Service and Maintenance; and Fire Extinguisher Service and Replacement for the Division of Refuse Collection, the Public Service Director be and hereby is authorized to expend \$15,700.00 or so much thereof as may be needed from Fund 010, the General Fund, Department No. 59-02, Division of Refuse Collection, Object Level One Code 03, Object Level Three Code 3372 and OCA Code 593566.

SECTION 3. That for the reason stated in the preamble here to, which is hereby made a part hereof, this ordinance is hereby declared to be an emergency measure and shall take effect and be in force from and after its passage and approval by the Mayor, or ten days after passage if the Mayor neither approves nor vetoes the same.

Legislation Number: 0188-2011

Drafting Date: 01/28/2011

Current Status: Passed

Version: 1

Matter Type: Ordinance

Explanation Background:

This ordinance will enable the Director of Recreation and Parks to accept a grant and to provide for the appropriation of said funds to the Recreation and Parks Grant Fund.

Grant funding is being made available by the Ohio Department of Aging to the Central Ohio Area Agency on Aging to provide outreach to eligible Medicare beneficiaries in Central Ohio. The Medicare Improvements for Patients & Providers Act for Beneficiary Outreach and Assistance Program (MIPPA-BOAP) grant is funded by the Administration on Aging (AOA) for a two-year period.

Emergency action is being requested due to the funding being made available retroactive to September 30, 2010.

Fiscal Impact:

\$57,428.00 in grant funding will be used to cover a portion of the payroll expenses for a Medicare Specialist currently employed by the Central Ohio Area Agency on Aging and to provide outreach and enrollment opportunities targeting limited income Medicare beneficiaries who are eligible for the Low-Income Subsidy and Medicare Savings Program. The fiscal impact of this ordinance will be to reduce the Recreation and Parks Grant Funds appropriated balance by \$57,428.00. The expenditure of \$57,428.00 is budgeted in the Recreation and Parks Grant Fund.

Title To authorize and direct the Director of Recreation and Parks to accept a grant to provide outreach to eligible Medicare beneficiaries in Central Ohio in the amount of \$57,428.00; to authorize an appropriation of \$57,428.00 from the unappropriated balance of the Recreation and Parks Grant Fund to the Recreation and Parks Department; and to declare an emergency. (\$57,428.00)

Body **WHEREAS**, the Ohio Department of Aging has awarded the Central Ohio Area Agency on Aging of the Columbus Recreation and Parks Department, a grant for the provision of outreach services to Medicare beneficiaries in Central Ohio; and

WHEREAS, an emergency exists in the usual daily operation of the Recreation and Parks Department in that it is immediately necessary to accept said grants, and appropriate said funds in a timely manner for the immediate preservation of the public health, peace, property and safety; **now, therefore**

BE IT ORDAINED BY THE COUNCIL OF THE CITY OF COLUMBUS:

Section 1. That the Director of Recreation and Parks be and he is hereby authorized and directed to accept a grant from the Ohio Department Department of Aging in the amount of \$57,428.00 for the period September 30, 2010 through September 29, 2012.

Section 2. That from the unappropriated monies in the Recreation and Parks Grant Fund No. 286 and from all monies estimated to come into said fund from any and all sources and unappropriated for any other purpose during the fiscal year ending December 31, 2010, the sum of \$57,428.00 is appropriated to the Recreation and Parks Department to pay the cost thereof as follows:

Department: 51-01 / **Grant Fund:** No. 286,

Medicare Improvements for Patients & Providers Act (MIPPA-BOAP)

Project No.: 511140 **OCA:** 511140 **OBJECT LEVEL 1:** 01 **AMOUNT:** \$6,428.00
Project No.: 511140 **OCA:** 511140 **OBJECT LEVEL 1:** 03 **AMOUNT:** \$51,000.00

Total: \$57,428.00

Section 3. That the monies in the foregoing Section 2 shall be paid upon the order of the Director of Recreation and Parks; and that no order shall be drawn or money paid except by voucher, the form of which shall be approved by the City Auditor.

Section 4. That the City Auditor is authorized to make any accounting changes to revise the funding source for all contracts or contract modifications associated with this legislation.

Section 5. That for the reasons stated in the preamble hereto, which is hereby made a part hereof, this Ordinance is hereby declared to be an emergency measure and shall take effect and be in force from and after passage and approval by the Mayor, or ten days after passage if the Mayor neither approves no vetoes same.

Legislation Number: 0191-2011

Drafting Date: 01/31/2011

Current Status: Passed

Version: 1

Matter Type: Ordinance

Explanation1. BACKGROUND

This legislation authorizes the Director of Public Service to enter into a professional services contract with Stantec Consulting Services, Inc. for the Bikeway Development - Professional Services contract for \$310,000.00.

The City of Columbus has developed a Bicentennial Bikeways Plan (BBP) which was adopted by City Council on June 2, 2008. The Plan identifies specific bikeways improvement projects located throughout the City. The Division of Mobility Options (Division) is responsible for the management and implementation of these improvement projects. It is the responsibility of the Offeror to produce a preliminary engineering report which analyzes the bikeway projects included in the BBP as well as additional projects identified by the Division.

The report shall include such items as, conceptual designs, preliminary alignments, traffic analyses, preliminary cost estimates, preliminary environmental analyses, as well as determinations of feasibility and constructability. The preliminary engineering report shall serve as the source document for future detailed design efforts. In order to successfully link a planning level project to a feasible and affordable design, the Offeror shall become familiar with the intent and methodology behind the BBP projects.

There are a variety of individual projects to be analyzed as part of this contract. Improvements are mostly within the right-of-way, and will consist mainly of projects identified in the BBP such as shared use paths, bike lanes, and shared routes and spot improvements. Potential projects to be analyzed include, but are not limited to, the following:

- Sullivant Avenue Corridor
- Broad Street Bike Lanes
- Henderson Road Shared-use Path
- Livingston Avenue Bike Lanes
- Summit Street Bike Lanes
- Fourth Street Bike Lanes
- Intersection Improvements
- RR Crossing Improvements

Work also includes conducting the necessary traffic engineering and parking analysis to refine BBP recommendations into practical "complete street" solutions. For example, road diets that require the removal of travel lanes and/or parking lanes must be analyzed for safety and capacity impacts as well as impacts to adjacent residents or businesses. Engineering analysis tools are required to analyze these potential impacts. Recommendations from the traffic engineering and parking

analysis will be illustrated in conceptual designs with cost estimates for public involvement meetings, as needed, before final design is completed.

The Department of Public Service, Office of Support Services solicited a Request for Proposal for the Bikeway Development - Professional Services project. This project was formally advertised through the City's Vendor Services from November 3, 2010, to December 3, 2010. The city received Nine responses. All proposals were deemed minimally compliant and were fully evaluated when the Evaluation Committee met on December 22, 2010.

<u>Company Name</u>	<u>City/State</u>	<u>Majority/MBE/FBE/ASN</u>
Stantec Consulting Services, Inc.	Columbus, OH	Majority
Transystems Corporation	Columbus, OH	Publicly Held Company
ME Companies	Westerville, OH	Majority
Resource International, Inc.	Columbus, OH	FBE
DLZ Ohio, Inc	Columbus, OH	ASN
EMH&T	Columbus, OH	Majority
Michael Baker Jr., Inc.	Columbus, OH	Majority
Columbus Engineering Consultants, Inc.	Columbus, OH	ASN
R.W. Armstrong & Associates, Inc	Columbus, OH	Publicly Held Company

Stantec Consulting Services, Inc. received the highest score by the evaluation committee and will be awarded the Bikeway Development - Professional Services Contract.

Searches in the Excluded Party List System (Federal) and the Findings for Recovery list (State) produced no findings against Stantec Consulting Services, Inc.

2. CONTRACT COMPLIANCE

Stantec Consulting Services, Inc's contract compliance number is 112167170 and expires 12/17/11.

3. EMERGENCY DESIGNATION

Emergency action is requested to provide this preliminary report for these projects at the earliest possible time in to expedite the planning of the City's bikeway program.

4. FISCAL IMPACT

Funds for this project are budgeted and available in the 2010 CIB in the Bikeway Development project.

TitleTo authorize the Director of Public Service to enter into a professional service engineering contract with Stantec Consulting Services, Inc. for the Bikeway Development - Professional Services project; to amend the 2010 C.I.B.; to authorize the transfer and expenditure of \$310,000.00 from within the Build America Bonds Fund; for the Division of Mobility Options; and to declare an emergency. (\$310,000.00)

Body**WHEREAS**, the City of Columbus has developed a Bicentennial Bikeways Plan, which was adopted by City Council on June 2, 2008 and this plan identifies specific bikeway improvement projects located throughout the City; and

WHEREAS, the Director of Public Service has identified the need to enter into a professional service engineering contract for the preparation of a preliminary engineering report which analyzes the bikeway projects included in the BBP as well as additional projects identified by the Division: and

WHEREAS, the report shall include such items as, conceptual designs, preliminary alignments, traffic analyses, preliminary cost estimates, preliminary environmental analyses, as well as determinations of feasibility and constructability; and

WHEREAS, the preliminary engineering report shall serve as the source document for future detailed design efforts; and

WHEREAS, The Department of Public Service solicited a request for proposal for the Bikeway Development -

professional services project; and

WHEREAS, a satisfactory proposal has been submitted by Stantec Consulting Services, Inc. and

WHEREAS, an emergency exists in the usual daily operation of the Department of Public Service, Division of Mobility Options, in that this legislation should go forth immediately to maintain the overall design schedule in order to have plans available for bikeway projects, thereby preserving the public health, peace, property, safety and welfare; now, therefore

BE IT ORDAINED BY THE COUNCIL OF THE CITY OF COLUMBUS:

SECTION 1. That the Director of Public Service be and is hereby authorized to enter into contract with Stantec Consulting Services, Inc., 1500 Lake Shore Drive, Suite 100, Columbus, OH, 43204 in the amount of \$310,000.00 or so much as may be needed for the Bikeway Development - Professional Services project.

SECTION 2. That the 2010 Capital Improvement Budget be amended to provide sufficient authority for this project as follows:

Fund / Project Number / Project / Current CIB Amount / Amendment Amount / CIB Amount

746 / 540002-100023 / Bikeway Development - Summit and Fourth / \$190,000.00 / (\$190,000.00) / \$0.00

746 / 540002-100024 / Bikeway Development - West Broad Street / \$120,000.00 / (\$120,000.00) / \$0.00

746 / 540002-100000 / Bikeway Development / \$0.00 / \$310,000.00 / \$310,000.00

SECTION 3. That the City Auditor be and hereby is authorized to transfer \$310,000.00 within Fund 746, the Build America Bonds Fund, Dept-Div 59-10, Division of Mobility Options as follows:

TRANSFER FROM

Fund / Project / Project Name / OL 01-03 Codes / OCA Code / amount

746 / 540002-100023 / Bikeway Development - Summit and Fourth / 06-6600 / 760223 / \$190,000.00

746 / 540002-100024 / Bikeway Development - West Broad Street / 06-6600 / 760224 / \$120,000.00

TRANSFER TO

Fund / project # / project / O.L. 01/03 Codes / OCA Code / amount

746 / 540002 - 100000 / Bikeway Development / 06-6600 / 760208 / \$310,000.00

SECTION 4. That for the purpose of paying the cost of this contract, the sum of \$310,000.00 or so much thereof as may be needed, is hereby authorized to be expended from the Build America Bonds Fund, No. 746 as follows:

Dept-Div / Project No. / Project Name / O.L. 01-03 Codes / OCA / Amount

746 / 540002 - 100000 / Bikeway Development / 06-6682 / 760208 / \$310,000.00

SECTION 5. That the City Auditor is authorized to make any accounting changes to revise the funding source for all contracts or contract modifications associated with this ordinance.

SECTION 6. That for the reasons stated in the preamble hereto, which is hereby made a part hereof, this ordinance is hereby declared to be an emergency measure and shall take effect and be in force from and after its passage and approval by the mayor, or ten days after passage if the mayor neither approves nor vetoes the same.

Legislation Number: 0192-2011

Drafting Date: 01/31/2011

Version: 1

Current Status: Passed

Matter Type: Ordinance

Ohio Department of Health through the Centers for Disease Control. This ordinance is needed to accept and appropriate \$1,054,751.00 in grant money to fund the Public Health Emergency Preparedness program for the period of August 10, 2010 through August 9, 2011.

The Public Health Emergency Preparedness program establishes the Franklin County/City of Columbus support network that would be required in the event of bioterrorism activity in the central region of the state of Ohio. It also allocates funding for Pandemic Influenza planning and operation activities in central Ohio, and the Cities Readiness Initiative.

This ordinance is submitted as an emergency so as to allow the financial transaction to be posted in the City's accounting system as soon as possible given the grant start date of August 10, 2010. Up to date financial posting promotes accurate accounting and financial management.

FISCAL IMPACT: The program is funded by the Ohio Department of Health and does not generate revenue. The program does require ancillary mileage monies from the City, which are budgeted and available.

Title To authorize and direct the Board of Health to accept additional grant monies from the Ohio Department of Health in the amount of \$1,054,751.00; to authorize the appropriation of \$1,054,751.00 from the unappropriated balance of the Health Department Grants Fund; and to declare an emergency. (\$1,054,751.00)

Body

WHEREAS, \$1,054,751.00 in grant funds have been made available through the Ohio Department of Health for the Public Health Emergency Preparedness program; and,

WHEREAS, this ordinance is submitted as an emergency so as to allow the financial transaction to be posted in the City's accounting system as soon as possible. Up to date financial posting promotes accurate accounting and financial management; and,

WHEREAS, an emergency exists in the usual daily operation of the Columbus Health Department in that it is immediately necessary to accept this grant from the Ohio Department of Health and to appropriate these funds to the Health Department for the immediate preservation of the public health, peace, property, safety, and welfare; Now, therefore:

BE IT ORDAINED BY THE COUNCIL OF THE CITY OF COLUMBUS:

SECTION 1. That the Board of Health is hereby authorized and directed to accept a grant award of \$1,054,751.00 from the Ohio Department of Health for the Public Health Emergency Preparedness program for the period August 10, 2010 through August 9, 2011.

SECTION 2. That from the unappropriated monies in the Health Department Grants Fund, Fund No. 251, and from all monies estimated to come into said Fund from any and all sources during the twelve months ending August 31, 2011, the sum of \$1,054,751.00 is hereby appropriated to the Health Department, Division No. 50, as follows:

Public Health Emergency Preparedness Grant:

OCA: 501122 Grant No.: 501055 Obj. Level 01: 03 Amount \$ 168,165
OCA: 501123 Grant No.: 501055 Obj. Level 01: 02 Amount \$ 24,024
OCA: 501123 Grant No.: 501055 Obj. Level 01: 03 Amount \$ 12,103
OCA: 501124 Grant No.: 501055 Obj. Level 01: 01 Amount \$ 60,000
OCA: 501124 Grant No.: 501055 Obj. Level 01: 02 Amount \$ 134,000
OCA: 501124 Grant No.: 501055 Obj. Level 01: 03 Amount \$ 656,459

Total Appropriation - \$1,054,751

SECTION 3. That the monies appropriated in the foregoing Section 2 shall be paid upon the order of the Health Commissioner, and that no order shall be drawn or money paid except by voucher, the form of which shall be approved by the City Auditor.

SECTION 4. That for reasons stated in the preamble hereto, which is hereby made a part hereof, this ordinance is declared to be an emergency measure and shall take effect and be in force from and after its passage and approval by the Mayor, or ten days after passage if the Mayor neither approves nor vetoes the same.

Legislation Number: 0197-2011

Drafting Date: 01/31/2011

Current Status: Passed

Version: 1

Matter Type: Ordinance

Explanation

BACKGROUND: The U.S. Department of Housing and Urban Development (HUD) requires grantees and their subrecipients to maintain Community Development Block Grant (CDBG) revolving loan funds in interest bearing accounts, and to remit said interest to the federal treasury no less frequently than annually. During 2010, the City's revolving loan fund earned interest of \$10,321.47. This legislation will authorize the expenditure of monies from the revolving loan subfund to remit 2010 interest earnings to HUD for the U.S. Treasury.

This legislation is presented as an emergency to facilitate the timely remittance of monies to HUD.

FISCAL IMPACT: Interest earnings have been deposited into the CDBG revolving loan fund and are available for disbursement to HUD from said fund.

Title

To authorize the Director of the Department of Finance and Management to expend \$10,321.47 from the CDBG revolving loan fund for payment of interest earnings to the U.S. Department of Housing and Urban Development (HUD); and to declare an emergency. (\$10,321.47)

Body

WHEREAS, federal regulations require Community Development Block Grant (CDBG) grantees and subrecipients to remit to the federal treasury all investment earnings paid on CDBG revolving loan accounts; and

WHEREAS, interest earnings have been deposited into the CDBG revolving loan subfund and are available for this expenditure; and

WHEREAS, an emergency exists in the usual daily operation of the Department of Finance and Management, in that it is immediately necessary to expend and remit the aforementioned funds to HUD, thereby preserving the public health, peace, property, safety and welfare; **Now, Therefore**

BE IT ORDAINED BY THE COUNCIL OF THE CITY OF COLUMBUS:

SECTION 1. That the director of the Department of Finance and Management is hereby authorized to expend \$10,321.47 from the Community Development Block Grant Fund, Fund No 248, Subfund 002, Department 45-01, OCA 459217, Object Level One: 05, Object Level Three: 5544.

SECTION 2. That the expenditure authorized in Section 1 shall be in the form of a wire transfer to HUD as follows: \$10,321.47 to the U.S. Treasury for 2010 CDBG revolving loan fund interest earnings.

SECTION 3. That for the reasons stated in the preamble hereto, which is hereby made a part hereof, this ordinance is hereby declared to be an emergency measure and shall take effect and be in force from and after its passage and approval by the Mayor or ten days after passage if the Mayor neither approves nor vetoes the same.

Legislation Number: 0201-2011

Drafting Date: 02/01/2011

Current Status: Passed

Version: 1

Matter Type: Ordinance

Explanation

Need: The Columbus Public Health (CPH) Department has a need to contract for security officer services for their facility at 240 Parsons Avenue. The purpose of this legislation is to enter into contract with United Security, LLC, for security services for the period March 1, 2011 to February 28, 2012.

A Request for Proposal (RFP), # SA003632 "Security Officer Services at 240 Parsons Avenue," was publicly posted to the City of Columbus Vendor Services website from June 14 until July 6, 2010. All 31 companies registered with the City of Columbus under commodity code 99046 (Guard and Security Services) were notified of the RFP. A total of six companies submitted responses to the RFP. The CPH evaluation committee unanimously recommended awarding the contract to United Security, LLC, as the lowest, responsive, responsible and best bidder under the provisions of City Code, Chapter 329. This is the first year of the five year contract. The contract compliance number for United Security, LLC, is 26-3179987 and expires on 10/21/11.

Fiscal Impact: These funds are budgeted within the Health Special Revenue Fund, Fund No. 250. This legislation is submitted as an emergency in order to avoid a break in the needed services provided by United Security, LLC.

Title

To authorize the Board of Health to enter into a contract with United Security, LLC, for security officer services; to authorize a total expenditure of \$315,000.00 from the Health Special Revenue Fund; and to declare an emergency. (\$315,000.00)

Body

WHEREAS, a need exists for security officer services for the Health Department facility located at 240 Parsons Avenue; and

WHEREAS, A Request For Proposal (RFP), # SA003632 "Security Officer Services at 240 Parsons Avenue," was publicly posted to the City of Columbus Vendor Services website from June 14 until July 6, 2010, and an evaluation committee unanimously recommended awarding the contract to United Security, LLC, as the lowest, responsive, responsible and best bidder under the provisions of City Code, Chapter 329; and,

WHEREAS, the Board of Health desires to enter into a contract with United Security, LLC, for the first year of the five-year contract; and,

WHEREAS, an emergency exists in the usual, daily operations of the Department of Health in that it is immediately necessary to enter into a contract for security officer services for the Health Department's 240 Parsons Avenue facility for the immediate preservation of the public peace, property, health, safety and welfare, now, therefore,

BE IT ORDAINED BY THE COUNCIL OF THE CITY OF COLUMBUS:

SECTION 1. That the Board of Health is hereby authorized to enter into a contract for \$315,000 with United Security LLC, for security officer services for the Health Department facility located at 240 Parsons Avenue for the period March 1, 2011 through February 28, 2012.

SECTION 2. That the expenditure of \$315,000 is hereby authorized from the Health Special Revenue Fund, Fund No. 250, Department of Health, Division No. 50-01, Object Level One - 03, Object Level Three -3398, OCA - 500264.

SECTION 3. That the City Auditor is authorized to make any accounting changes to revise the funding source for all contracts or contract modifications associated with this ordinance and to make any accounting changes necessary to ensure that this contract is properly accounted for and recorded accurately on the City's financial records.

SECTION 4. That for reasons stated in the preamble hereto, which is hereby made a part thereof, this ordinance is hereby declared to be an emergency measure and shall take effect and be in force from and after its passage and approval by the Mayor, or ten days after passage if the Mayor neither approves nor vetoes the same.

Legislation Number: 0207-2011

Drafting Date: 02/01/2011

Current Status: Passed

Version: 1

Matter Type: Ordinance

Explanation

BACKGROUND: This legislation authorizes the Director of the Department of Development to enter into contracts with various non-profit organizations to support the operation of the City's Chores Program. The total amount of these contracts is \$150,000 from the Community Development Block Grant (CDBG) Fund through the Housing Division's Affordable Housing Opportunity Fund (AHOF).

The AHOF represents the City's commitment to the preservation and production of housing units affordable to very-low, low and moderate-income individuals. Funds are used to meet the housing needs identified in the 2010-2014 Consolidated Plan. Programs provide housing rehabilitation assistance, lead paint hazard control, home maintenance repairs for elderly and disabled households, and accessibility modifications.

The Chores Program provides minor home maintenance and repair services to low and low/moderate-income elderly and disabled homeowner-occupants in the City of Columbus. Examples of program services include replacement or repair of leaking faucets and commodes, faulty light fixtures and switches, loose or missing sections of porch decking or steps and installation of handrails, smoke detectors and deadbolt locks. Eligible homeowners receive home repair services (materials and labor) free of charge. Rebuilding Together Central Ohio, Economic and Community Development Institute, and Lifecare Alliance will be the program providers to neighborhoods within the corporate limits of Columbus. This program will help about 200 households.

Emergency action is requested to allow program services to continue without interruption.

FISCAL IMPACT: Funds for this expenditure are allocated from the 2011 Community Development Block Grant Fund.

Title

To authorize the Director of the Department of Development to enter into contracts with various non-profit organizations for the implementation of the Chores Program; to authorize the expenditure of \$150,000.00 from the Community Development Block Grant Fund; and to declare an emergency. (\$150,000.00)

Body

WHEREAS, the Director of the Department of Development desires to enter into contracts with various non-profit organizations to implement the Chores Program; and

WHEREAS, the Chores Program will provide minor home maintenance and repair services to low and low/moderate-income elderly and disabled homeowner-occupants in the City of Columbus; and

WHEREAS, Rebuilding Together Central Ohio, Economic and Community Development Institute, and Lifecare Alliance are non-profit organizations with the capacity to provide Chores program services; and

WHEREAS, an emergency exists in the usual daily operation of the City in that it is immediately necessary to enter into contracts with the Rebuilding Together Central Ohio, Economic and Community Development Institute, and Lifecare Alliance so that necessary services will not be interrupted, all for the preservation of the public health, peace, property, safety and welfare; and **NOW THEREFORE**,

BE IT ORDAINED BY THE COUNCIL OF THE CITY OF COLUMBUS:

Section 1. That the Director of the Department of Development is hereby authorized to enter into contracts with Rebuilding Together Central Ohio, Economic and Community Development Institute, and Lifecare Alliance for the purpose of implementing the Chores basic home maintenance and repair program.

Section 2. That these contracts are awarded pursuant to Section 329.15 of the Columbus City Codes, 1959, as amended.

Section 3. That for the purpose as stated in Section 1, the expenditure of \$150,000.00 or so much thereof as necessary, be and is hereby authorized to be expended from the Department of Development, Department No. 44-10, Fund 248, Object Level One 03, Object Level Three 3336, OCA 440236 as follows:

<u>AGENCY</u>	<u>AMOUNT</u>
Rebuilding Together Central Ohio	\$50,000
Economic and Community Development Institute	\$50,000
Lifecare Alliance	<u>\$50,000</u>

Total Allocation \$150,000

Section 4. That for the reasons stated in the preamble hereto, which hereby made a part hereof, this ordinance is hereby declared to be an emergency measure and shall take effect and be in force from and after its passage and approval by the Mayor, or ten days after passage if the Mayor neither approves nor vetoes the same.

Legislation Number: 0217-2011

Drafting Date: 02/02/2011

Current Status: Passed

Version: 1

Matter Type: Ordinance

Explanation

BACKGROUND: The need exists to amend Ordinance 1298-2010, approved by Columbus City Council on September 20, 2010. That ordinance authorized the Director of the Department of Development to enter into a Jobs Creation Tax Credit Agreement of 65% for six years and a Jobs Growth Incentive Agreement of 25% for five years with International Technical Coatings, Inc. Additional time is now needed to review and execute the agreements. This amendment will allow the extension of the period needed to execute the agreements to 90 days after passage of this ordinance.

International Technical Coatings, Inc. plans to expand its manufacturing operations to 805-845 Markison Avenue, create 120 new permanent full-time jobs, invest \$17.3 million and increase job opportunities and strengthen the economy of the city upon the execution of these agreements. Receiving these tax credits from the city is a critical factor in International Technical Coatings Inc.'s decision to go forward with the expansion project in Columbus.

FISCAL IMPACT: No funding is required for this legislation.

Title

To amend ordinance 1298-2010, passed by Columbus City Council on September 20, 2010, to extend the period of execution for the Jobs Creation Tax Credit and the Jobs Growth Incentive Agreements with International Technical Coatings, Inc.; and to declare an emergency.

Body

WHEREAS, International Technical Coatings, Inc. plans to expand its manufacturing operations to 805-845 Markison Avenue Columbus, Ohio, create 120 new permanent full-time jobs, invest \$17.3 million and increase job opportunities and strengthen the economy of the city upon the execution of these agreements; and

WHEREAS, receiving these tax credits from the State and the City is a critical factor in International technical Coatings Inc.'s decision to go forward with the expansion project in Columbus; and

WHEREAS, additional time is needed to review and execute the Jobs Creation Tax Credit Agreement and the Jobs Growth Incentive Agreement; and

WHEREAS, the City of Columbus desires to facilitate the future growth of International Technical Coatings, Inc. at the project site; and

WHEREAS, this amendment will allow the extension of the period needed to execute the agreements to 90 days after passage of this ordinance; and

WHEREAS, an emergency exists in the usual daily operation of the City of Columbus, Department of Development in that it is immediately necessary to amend ordinance 1298-2010 to extend the period of execution for the Job Creation Tax Credit Agreement and Jobs Growth Incentive Agreement with International Technical Coatings, Inc. in order to allow the company to begin construction of the facility and to create jobs as quickly as possible, all for the preservation of public health, peace, prosperity and safety; **NOW THEREFORE**,

BE IT ORDAINED BY THE COUNCIL OF THE CITY OF COLUMBUS:

Section 1. That Ordinance 1298-2010 is hereby amended to extend the period of execution of the agreements to 90 days from the approval date of this legislation.

Section 2. That the City of Columbus Job Creation Tax Credit Agreement and Jobs Growth Incentive Agreement are signed by International Technical Coatings, Inc. within 90 days of passage of this ordinance, or this ordinance and the credit herein shall be null and void.

Section 3. That for reasons stated in the preamble hereto, which is hereby made a part hereof, this ordinance is hereby declared to be an emergency measure and shall take effect and be in force from and after its passage and approval by the Mayor or ten days after the passage if the Mayor neither approves nor vetoes the same.

Legislation Number: 0218-2011

Drafting Date: 02/02/2011

Version: 1

Current Status: Passed

Matter Type: Ordinance

Explanation

BACKGROUND:

This legislation authorizes the Director of Finance and Management to enter into a subscription agreement with KOREnergy (KORE), a Curtailment Service Provider, for access to the Demand Response Programs offered by PJM Interconnection, Inc. (PJM) and for the Department of Finance and Management to participate in these PJM programs. KORE is a member PJM and as a Curtailment Service Provider is authorized to represent the City with PJM.

The Demand Response Program is managed by PJM, a federally regulated non-profit entity that manages the electric transmission grid in a thirteen-state territory, which includes 51 million people and 20 percent of the U.S. economy.

The Demand Response Program is a voluntary program where customers agree to reduce electricity use during times of high demand that helps maintain grid reliability by reducing the stress on the electrical grid system. PJM encourages demand response activity in the PJM grid to help reduce wholesale electricity prices and reduce electricity usage to address environmental concerns. KORE will pay the City a premium for temporarily curtailing a portion of the City's energy use through high-return Integrated Demand Response strategies.

In the event of record-high temperatures, mechanical failures at power plants or the transmission grid in our region various City buildings will either disconnect from the grid or will reduce power demand to a predetermined level. If a building were to disconnect this power would be offset by a switch over to a back up power generator.

The Demand Response Program helps the environment and helps reduce the rates utility customers pay during warm summer months. By recruiting eligible customers to voluntarily reduce usage, PJM is able to delay or defer the construction of new power plants. The program also allows PJM to avoid purchasing more expensive power from other regions of the country.

This program will allow the City to earn money for being on standby or for participating in calls to temporarily reduce a portion of the electrical load in response to grid- or utility-initiated curtailment events. The PJM program could potentially call on the City to participate in energy curtailment events during the months of June through September, from zero to ten event requests during that time frame, and only during the hours of noon to 8 p.m. If no events are called, the City will earn money for being willing to stand by and participate in a one-hour test to be scheduled in the month of either July or August 2011.

For participation in the program, KORE shall make four quarterly payments to the City.

If adverse weather conditions or other events prohibit us from participating in the programs, no cost or penalty will be burdened by the City. The City will forgo its scheduled payment.

KOREnergy, Ltd.: Contract Compliance No. 27-0398182, expiration date February 2, 2013.

Emergency designation is being requested so that the March 1, 2011 deadline to enter into the program can be met.

Competitive bidding is to be waived because of the pilot nature of this project. As the City learns more about the demand response programs, and which buildings are the most appropriate participants, and have a number of buildings for which the City can offer a portfolio to prospective vendors, the City will competitively bid. KORE is willing to work with the City to start the project with just a few buildings, whereas other PJM members were not.

FISCAL IMPACT: No expenditure is necessary. The Department of Finance and Management estimates \$22.50 per kW in revenue for the first year of the program for all load enrolled in by March 1, 2011.

Title

To authorize the Director of Finance and Management to enter into a subscription agreement with KOREnergy, to allow the participation in the PJM demand response programs for the one or more City facilities; to waive the City Code provisions for competitive bidding; and to declare an emergency.

Body

WHEREAS, the Department of Finance and Management desires to participate in demand response energy curtailment

programs to enhance the electrical grid capacity during high peak demand and to help reduce wholesale electricity prices and reduce electricity usage to address environmental concerns, and to provide an opportunity to secure a revenue source for the City; and

WHEREAS, it is necessary to enter into a subscription agreement with KOREnergy, in order to allow us to participate in the available demand response programs; and

WHEREAS, KOREnergy is not a sole source provider of this type of service; however, the Department of Finance and Management would like to enter into an agreement with Columbus, Ohio-based KOREnergy to assess the viability of this program; and

WHEREAS, the revenue for this demand response energy curtailment participation will be negotiated by City representatives and the KOREnergy personnel; and

WHEREAS, this ordinance is being submitted waiving the requirements of competitive bidding provisions of Columbus City Codes, Section 329; and

WHEREAS, an emergency exists in the usual daily operation of the Department of Finance and Management, in that it is immediately necessary to execute a subscription agreement with KOREnergy to allow the Department of Finance and Management to participate in the program consistent with the participant contract submittal deadline of March 1, 2011;
now, therefore:

BE IT ORDAINED BY THE COUNCIL OF THE CITY OF COLUMBUS:

Section 1. That the Director of Finance and Management be, and hereby is, authorized to enter into a subscription agreement with KOREnergy, P.O Box 148, Sunbury, Ohio 43074, and to allow for the participation in the available PJM Demand Response Programs under the direction of the Director of Finance and Management as deemed appropriate.

Section 2. That this Council finds it in the best interest of the City of Columbus to waive the competitive bidding provisions of the Columbus City Codes, Section 329.

Section 3. That for the reasons stated in the preamble hereto, where is hereby made a part hereof, this Ordinance is hereby declared to be an emergency measure, which shall take effect and be in force from and after its passage and approval by the Mayor, or ten days after passage if the Mayor neither approves nor vetoes the same.

Legislation Number: 0219-2011

Drafting Date: 02/02/2011

Current Status: Passed

Version: 1

Matter Type: Ordinance

Explanation

BACKGROUND: This ordinance authorizes the appropriation of a portion of the FY 2011 HOME monies within the HOME Investment Partnerships Program to the Department of Development. Since the federal government has not yet finalized the 2011 funding levels for the HOME Program, an ordinance is needed to appropriate critical components of the program. Specifically, administrative dollars and funding for Tenant Based Rental Assistance (TBRA) activities are immediately needed. This ordinance is in accordance with Ordinance 1330-2009 passed November 9, 2009, authorizing the adoption and filing of the Consolidated Plan and application to the U.S. Department of Housing and Urban Development (HUD).

The funds will be allocated as follows: \$325,000.00 for the Affordable Housing Opportunity Fund - Tenant Based Rental Assistance (TBRA) and \$400,000.00 for HOME administration. It is anticipated that the City of Columbus will receive

approximately \$5,000,000.00 in HOME funding. The balance of the HOME dollars will be requested to be appropriated and expended once the actual allocation amount is received from HUD.

Emergency action is requested to allow for continuation of services without interruption.

FISCAL IMPACT: The City of Columbus is awarded approximately \$5 million by the United States Department of Housing and Urban Development (HUD) to fund various housing assistance activities under the HOME Investment Partnerships Program. This ordinance requests the appropriation of \$725,000.00. Separate ordinances are being submitted for the expenditure of the Tenant Based Rental Assistance (\$325,000.00). In addition, once the allocation amount is received from HUD a request will be made to City Council to appropriate and expend the balance of the HOME dollars.

Title

To authorize an appropriation of \$725,000.00 from the HOME Fund to provide funding for various approved 2011 programs; and to declare an emergency. (\$725,000.00)

Body

WHEREAS, it is necessary to appropriate funds from the unappropriated balance of the 2011 HOME Fund to the Department of Development; and

WHEREAS, HOME funds will be used for administrative dollars and funding for Tenant Based Rental Assistance (TBRA) activities that will assist in increasing and preserving the local supply of decent, safe, sanitary, and affordable housing for low income individuals and families; and

WHEREAS, an emergency exists in the usual daily operation of the Department of Development, Housing Division, in that it is immediately necessary to appropriate said funds to allow for continuation of vital program services without interruption, thereby preserving the public health, peace, property, safety, and welfare; and **NOW, THEREFORE,**

BE IT ORDAINED BY THE COUNCIL OF THE CITY OF COLUMBUS:

Section 1. That from the unappropriated monies in the fund known as the HOME Fund, Fund No. 201, Grant 458001 and from all monies estimated to come into said fund from any and all sources during the 12 months ending December 31, 2011, there be and hereby is appropriated to Division 44-10 the following sums:

Affordable Housing Opportunity Fund:

Object Level One / Object Level Three / OCA Code / Amount

03 / 3337 / 440231 / \$325,000

Home Administration:

Object Level One / Object Level Three / OCA Code / Amount

01 / 1101 / 440230 / \$400,000

TOTAL FUND NO. 201 \$725,000

Section 2. That the monies appropriated in the foregoing Section 1 shall be paid upon the order of the Director of the Department of Development and that no order shall be drawn or money paid except by voucher, the form of which shall be approved by the City Auditor.

Section 3. That the Director of the Department of Development is hereby authorized to use HOME funds for administrative dollars and funding for Tenant Based Rental Assistance (TBRA) activities that will assist in increasing and preserving the local supply of decent, safe, sanitary, and affordable housing for low income individuals and families

Section 4. That for the reasons stated in the preamble hereto, which is hereby made a part hereof, this Ordinance is hereby declared to be an emergency measure and shall take effect and be in force from and after its approval by the Mayor, or ten days after passage if the Mayor neither approves nor vetoes the same.

Legislation Number: 0220-2011

Drafting Date: 02/02/2011

Current Status: Passed

Version: 1

Matter Type: Ordinance

Explanation

BACKGROUND: The City is a participating jurisdiction receiving federal funds under the HOME Investment Partnerships program (HOME) of the U. S. Department of Housing and Urban Development (HUD). The regulations of the program provide that funds may be used to administer a tenant-based rental assistance program.

This legislation authorizes the Director of Development to enter into a contract with the Southeast, Inc for the purpose of implementing and monitoring the program on behalf of the City. The contract will provide \$161,000.00 of HOME Funds. The Tenant Based Rental Assistance Program (TBRA) will use HOME funds to provide rental subsidies and security deposits for chronically homeless persons participating in the Rebuilding Lives initiative. Rebuilding Lives enables the development and maintenance of permanent supportive housing for chronically homeless persons.

HOME Fund regulations for TBRA are very similar to HUD's Section 8 Program. The Southeast, Inc will lease housing units for the Rebuilding Lives program. Southeast, Inc will maintain and operate the housing unit and related facilities to provide decent, safe and sanitary housing in accordance with the HUD Housing Quality Standards. The Columbus Metropolitan Housing Authority (CMHA) will inspect units. The City's Consolidated Action Plan for 2010 contains TBRA housing preference priorities for chronically homeless persons.

Emergency action is requested in order to ensure rental subsidies are in place for 2011.

FISCAL IMPACT: Funds for this expenditure are allocated from the Rebuilding Lives set-aside within the Affordable Housing Opportunity Fund allocation of the 2011 HOME Funds.

Title

To authorize the Director of the Department of Development to enter into contract with the Southeast, Inc to provide tenant-based rental assistance; to authorize the expenditure of \$161,000.00 from the HOME Fund; and to declare an emergency. (\$161,000.00)

Body

WHEREAS, the City of Columbus is the recipient of HOME Investment Partnerships funds from the U.S. Department of Housing and Urban Development; and

WHEREAS, the City is a partner in the Rebuilding Lives initiative to provide permanent supportive housing to chronically homeless persons; and

WHEREAS, the City desires to assist the Rebuilding Lives initiative by establishing a tenant-based rental assistance program; and

WHEREAS, the City desires to enter into a contract with the Southeast, Inc in order to administer and operate the tenant-based rental assistance program; and

WHEREAS, there is an immediate need for tenant-based rental assistance to continue rent subsidies for participants in the

Rebuilding Lives Program; and

WHEREAS, an emergency exists in the usual daily operation of the Department of Development, Housing Division, in that it is immediately necessary to enter into a contract with the Southeast, Inc to permit the payment of tenant-based rental assistance to begin immediately, thereby preserving the public health, peace, property, safety, and welfare; and **NOW THEREFORE**,

BE IT ORDAINED BY THE COUNCIL OF THE CITY OF COLUMBUS:

- Section 1.** That the Director of the Department of Development be and is hereby authorized to enter into a contract with the Southeast, Inc to provide tenant-based rental assistance.
- Section 2.** That for the purpose as stated in Section 1 the expenditure of \$161,000.00 or so much thereof as may be necessary, be and is hereby authorized to be expended from the Department of Development, Department No. 44-10, Fund 201, Grant No. 458001, Object Level One 03, Object Level Three 3337, OCA 440231.
- Section 3.** That this contract is awarded pursuant to Section 329.15 of the Columbus City Codes, 1959, as amended.
- Section 4.** That for the reasons stated in the preamble hereto, which is hereby made a part hereof, this Ordinance is hereby declared to be an emergency measure and shall take effect and be in force from and after its approval by the Mayor, or ten days after passage if the Mayor neither approves nor vetoes the same.

Legislation Number: 0221-2011

Drafting Date: 02/02/2011

Current Status: Passed

Version: 1

Matter Type: Ordinance

Explanation

BACKGROUND: The City is a participating jurisdiction receiving federal funds under the HOME Investment Partnerships program (HOME) of the U. S. Department of Housing and Urban Development (HUD). The regulations of the program provide that funds may be used to administer a tenant-based rental assistance program.

This legislation authorizes the Director of Development to enter into a contract with the YMCA of Central Ohio for the purpose of implementing and monitoring the program on behalf of the City. The contract will provide \$164,000.00 of HOME Funds. The Tenant Based Rental Assistance Program (TBRA) will use HOME funds to provide rental subsidies and security deposits for chronically homeless persons participating in the Rebuilding Lives initiative. Rebuilding Lives enables the development and maintenance of permanent supportive housing for chronically homeless persons.

HOME Fund regulations for TBRA are very similar to HUD's Section 8 Program. The YMCA will lease housing units for the Rebuilding Lives program. The YMCA will maintain and operate the housing unit and related facilities to provide decent, safe and sanitary housing in accordance with the HUD Housing Quality Standards. The Columbus Metropolitan Housing Authority (CMHA) will inspect units. The City's Consolidated Action Plan for 2010 contains TBRA housing preference priorities for chronically homeless persons.

Emergency action is requested in order to ensure rental subsidies are in place for 2011.

FISCAL IMPACT: Funds for this expenditure are allocated from the Rebuilding Lives set-aside within the Affordable Housing Opportunity Fund allocation of the 2011 HOME Funds.

Title

To authorize the Director of the Department of Development to enter into a contract with the YMCA of Central Ohio to

provide tenant-based rental assistance; to authorize the expenditure of \$164,000.00 from the HOME Fund; and to declare an emergency. (\$164,000.00)

Body

WHEREAS, the City of Columbus is the recipient of HOME Investment Partnerships funds from the U.S. Department of Housing and Urban Development; and

WHEREAS, the City is a partner in the Rebuilding Lives initiative to provide permanent supportive housing to chronically homeless persons; and

WHEREAS, the City desires to assist the Rebuilding Lives initiative by establishing a tenant-based rental assistance program; and

WHEREAS, the City desires to enter into a contract with the YMCA in order to administer and operate the tenant-based rental assistance program; and

WHEREAS, there is an immediate need for tenant-based rental assistance to continue rent subsidies for participants in the Rebuilding Lives Program; and

WHEREAS, an emergency exists in the usual daily operation of the Department of Development, Housing Division, in that it is immediately necessary to enter into a contract with the YMCA to permit the payment of tenant-based rental assistance immediately, thereby preserving the public health, peace, property, safety, and welfare; and **NOW THEREFORE**,

BE IT ORDAINED BY THE COUNCIL OF THE CITY OF COLUMBUS:

- Section 1.** That the Director of the Department of Development be and is hereby authorized to enter into a contract with the YMCA of Central Ohio to provide tenant-based rental assistance.
- Section 2.** That for the purpose as stated in Section 1 the expenditure of \$164,000.00 or so much thereof as may be necessary, be and is hereby authorized to be expended from the Department of Development, Department No. 44-10, Fund 201, Grant No. 458001, Object Level One 03, Object Level Three 3337, OCA 440231.
- Section 3.** That this contract is awarded pursuant to Section 329.15 of the Columbus City Codes, 1959, as amended.
- Section 4.** That for the reasons stated in the preamble hereto, which is hereby made a part hereof, this Ordinance is hereby declared to be an emergency measure and shall take effect and be in force from and after its approval by the Mayor, or ten days after passage if the Mayor neither approves nor vetoes the same.

Legislation Number: 1812-2010

Drafting Date: 12/06/2010

Version: 1

Current Status: Passed

Matter Type: Ordinance

Explanation

BACKGROUND: The Department of Public Utilities requires the operators of our treatment plants and distribution system to be licensed by the State of Ohio. They receive specialized utility operations and maintenance training through the Operator Training Committee of Ohio (OTCO). OTCO is the State of Ohio's Environmental Training Center under the Clean Water Act. For this reason, the Department of Public Utilities would like to enter into a sole-source contract with

the Operator Training Committee of Ohio for specialized utility operations and maintenance training for department personnel, in the amount of \$60,000.00. This contract will run through March 31, 2012. The Federal Identification Number for the Operator Training Committee of Ohio is 31-6065198. They are classified as a non-profit organization and do not require a contract compliance number.

The company is not debarred according to the Excluded Party Listing System of the Federal Government or prohibited from being awarded a contract according to the Auditor of State Unresolved Findings for Recovery Certified Search.

FISCAL IMPACT: There is sufficient budget authority for this purchase.

\$20,000.00 was encumbered in 2009 and \$75,000.00 was encumbered in 2008 for specialized utility operations and maintenance training. This ordinance is contingent on the passage of the 2011 operating budget.

Title

To authorize the Director of Public Utilities to enter into a sole-source contract with the Operator Training Committee of Ohio (OTCO), for utility operations and maintenance training, in accordance with the sole source provisions of the Columbus City Code, for the Department of Public Utilities, and to authorize the expenditure of \$3,660.00 from the Electricity Operating Fund, \$26,100.00 from the Sewerage System Operating Fund , \$6,960.00 from the Storm Sewer Operating Fund and \$23,280.00 from the Water Systems Operating Fund. (\$60,000.00)

Body

WHEREAS, the Department of Public Utilities requires the operators of our treatment plants and distribution system to be licensed by the State of Ohio, and

WHEREAS, they receive specialized utility operations and maintenance training through the Operator Training Committee of Ohio (OTCO), which is the State of Ohio's Environmental Training Center under the Clean Water Act, and

WHEREAS, it has become necessary in the usual daily operation of the Division of Power and Water, Department of Public Utilities, to authorize the Director of Public Utilities to establish a sole-source contract for utility operations and maintenance training, from the Operator Training Committee of Ohio (OTCO), for the preservation of public health, peace, property and safety; now, therefore,

BE IT ORDAINED BY THE COUNCIL OF THE CITY OF COLUMBUS:

Section 1. That the Director of Public Utilities be and is hereby authorized to enter into a sole-source contract with the Operator Training Committee of Ohio (OTCO) for utility operations and maintenance training, in accordance with the sole source provisions of Section 329.07(e) of the Columbus City Code, for the Department of Public Utilities.

Section 2. That the expenditure of \$60,000.00, or so much thereof as may be needed, is hereby authorized to be expended from:

Division 60-07 | Electricity Operating Fund 550 | OCA Code 600023 | Object Level Three 3331 | \$3,660.00

Division 60-05 | Sewerage System Operating Fund 650 | OCA Code 600056 | Object Level Three 3331 | \$26,100.00

Division 60-15 | Storm Sewer Operating Fund 675 | OCA Code 600065 | Object Level Three 3331 | \$6,960.00

Division 60-09 | Water Systems Operating Fund 600 | OCA Code 600049 | Object Level Three 3331 | \$23,280.00

Section 3. That this Ordinance shall take effect and be in force from and after the earliest period allowed by law.

The following ordinance was passed on 10/18/2010 and was inadvertently not published properly in the City Bulletin

**City of Columbus
City Bulletin Report**

Office of City Clerk
90 West Broad Street
Columbus OH 43215-9015
columbuscitycouncil.org

Legislation Number: 1386-2010

Drafting Date: 09/21/2010

Current Status: Passed

Version: 2

Matter Type: Ordinance

Explanation

1. BACKGROUND: This legislation authorizes the Director of Public Utilities to enter into a multi-year agreement with URS Corporation - Ohio to provide cost effective construction management, field representation, inspection testing, instrumentation/control design, integration and support services, and services for maintenance of operations during construction for various capital improvements projects for the Water Supply/Technical Support group.

2. FUTURE CONTRACT MODIFICATIONS: This series of agreements will establish fixed direct labor, overhead, and fixed fee rates for the period of 2011 - 2015. The Water Supply/Technical Support group anticipates requesting additional appropriations to this contract for construction contracts through fiscal year 2015, through planned contract modifications duly authorized by City Council. The rates schedules established within this contract will remain in force throughout the life of the contract.

The first task of this project requires the construction management team to perform a constructability review of the bidding documents for the Upground Reservoir project. This project is expected to be advertised for bid in December 2010.

3. BID INFORMATION: The selection of the firm providing the professional construction management services has been performed in accordance with the procedures set forth in Columbus City Code, Section 329.14, "Awarding professional service contracts through requests for proposals." Requests for Proposals (RFP's) were received on July 16, 2010 from URS Corporation - Ohio and Gilbane JVC.

An evaluation committee reviewed the proposals and scored them using predetermined criteria. Based on the evaluation of the proposals submitted, the Director of Public Utilities requests award of the project to URS Corporation - Ohio

The Contract Compliance Number for URS Corporation - Ohio is 34-0939859 (expires 8/28/11, Majority). Additional information regarding both bidders, description of work, contract time frame and detailed amounts can be found on the attached Information form.

4. EMERGENCY DESIGNATION: It is requested that this Ordinance be handled in an emergency manner to allow the constructability review to be completed prior to the project advertisement of December 2010, so that any recommended revisions can be incorporated into the bidding documents.

5. FISCAL IMPACT: A transfer of funds within the Water Build America Bonds Fund will be necessary, as well as an amendment to the 2010 Capital Improvements Budget.

Title

To authorize the Director of Public **Utilities** to enter into a multi-year agreement with URS Corporation - Ohio for professional construction management services for Water Supply Group projects; to authorize a transfer and expenditure of \$200,000.00 within the Water Build America Bonds Fund for the Professional Construction Management - Upground Reservoir project; to amend the 2010 Capital Improvements Budget; for the Division of Power and Water; and to declare an emergency. (\$200,000.00)

Body

WHEREAS, two technical proposals for professional construction management services for the Water Supply Group projects were received on July 16, 2010; and

WHEREAS, URS Corporation - Ohio was the firm selected to perform the design services for this project based on criteria set forth in Columbus City Codes; and

WHEREAS, the Division of Power and Water would like to enter into a multi-year professional construction management agreement with URS Corporation - Ohio for Water Supply Group projects; and

WHEREAS, it is necessary for this Council authorize the transfer within and expenditure of funds from the Water Build America Bonds Fund, for the Division of Power and Water, and

WHEREAS, it is necessary to authorize an amendment to the 2010 Capital Improvements Budget for the purpose of providing sufficient spending authority for the aforementioned project expenditure; and

WHEREAS, an emergency exists in the usual daily operation of the Division of Power and Water, Department of Public Utilities, in that it is immediately necessary to authorize the Director of Public Utilities to enter into a multi-year agreement with URS Corporation - Ohio for professional construction management services for Water Supply Group projects, in an emergency manner to allow the constructability review to be implemented and recommended revisions be incorporated into the bidding documents, prior to the December 2010 advertisement, for the immediate preservation of the public health, peace, property and safety;

BE IT ORDAINED BY THE COUNCIL OF THE CITY OF COLUMBUS:

SECTION 1. That the Director of Public Utilities be and hereby is authorized to enter into a multi-year agreement for professional construction management services for Water Supply Group projects; with the best, responsive and responsible bidder, URS Corporation - Ohio, 277 West Nationwide Blvd., Columbus, Ohio 43215; in the amount of \$200,000.00; in accordance with the terms and conditions of the contract on file in the Office of the Division of Power and Water.

SECTION 2. That the City Auditor is hereby authorized to transfer \$200,000.00 within the Department of Public Utilities, Division of Power and Water, Water Build America Bonds Fund, Fund No. 609, Dept/Div. No. 60-09, Object Level Three 6686, as follows:

Fund No. | Project No. | Project Name | OCA Code | Change

609 | 690026-100002 (carryover) | 910/Indianola Bldg. Imp's | 692602 | -\$35,018.35
609 | 690236-100019 (carryover) | Alton-Darby Rd. W.L. | 623619 | -\$19,797.88
609 | 690236-100021 (carryover) | River South Ph. 2 | 623621 | -\$145,183.77
609 | 690518-100001 (carryover) | Constr. Mgmt.-Upground Reservoir | 695181 | +\$200,000

SECTION 3. That the 2010 Capital Improvements Budget is hereby amended as follows:

Fund No. | Proj. No. | Proj. Name | Current Authority | Revised Authority | Change

609 | 690026-100002 (carryover) | 910/Indianola Bldg. Imp's | \$300,000 | \$300,001 | +\$1 (establish enough authority for change)
609 | 690026-100002 (carryover) | 910/Indianola Bldg. Imp's | \$300,001 | \$264,982 | -\$35,019
609 | 690236-100019 (carryover) | Alton-Darby Rd. W.L. | \$102,177 | \$121,975 | +\$19,798 (establish authority for cancellation)
609 | 690236-100019 (carryover) | Alton-Darby Rd. W.L. | \$121,975 | \$102,177 | -\$19,798
609 | 690236-100021 (carryover) | River South Ph. 2 | \$2,361,233 | \$2,216,049 | -\$145,184
609 | 690518-100001 (carryover) | Constr. Mgmt.-Upground Reservoir | \$0 | \$200,001 | +\$200,001

SECTION 4. That the expenditure of \$200,000.00 is hereby authorized for construction management services for Water Supply Group projects within the Water Build America Bonds Fund, Fund No. 609, Division 60-09, Project Name: Construction Management - Upground Reservoir, Project No. 690518-100001 (carryover), OCA Code 695181, Object Level Three 6686.

SECTION 5. That the City Auditor is authorized to make any accounting changes to revise the funding source for all contracts or contract modifications associated with this Ordinance.

SECTION 6. That the City Auditor is hereby authorized and directed to transfer any unencumbered balance in the project account to the unallocated balance within the same fund upon receipt of certification by the Director of the Department administering said project that the project has been completed and the monies no longer required for said project; except that no transfer shall be made from a project account by monies from more than one source.

SECTION 7. That the City Auditor is authorized to establish proper project accounting numbers as appropriate.

SECTION 8. That for reasons stated in the preamble hereto, which is hereby made a part hereof, this Ordinance is declared to be an emergency measure and shall take effect and be in force from and after its passage and approval by the Mayor, or ten days after passage if the Mayor neither approves nor vetoes the same.

City RFPs, RFQs, and Bids

THE CITY BULLETIN
BIDS WANTED - PURCHASING OFFICE AND OTHER DIVISIONS

CITY OF COLUMBUS FORMAL BID OPPORTUNITIES ARE UPDATED DAILY AT:

<http://vendorservices.columbus.gov/e-proc/venSolicitationsAll.asp?link=Open+Solicitations&cboType=B>

Each proposal shall contain the full name and address of every person, firm or corporation interested in the same, and if corporation, the name and address of the President and Secretary.

EQUAL OPPORTUNITY CLAUSE: Each responsive bidder shall submit, with its bid, a contract compliance certification number or a completed application for certification. Compliance with the provisions of Article I, Title 39, is a condition of the contract. Failure to comply with this Article may result in cancellation of the contract.

WITHHOLDING OF INCOME TAX: All bidders are advised that in order for a contract to bind the City, each contract must contain the provisions found in Section 361.35 C.C.C. with regard to income taxes due or payable to the City of Columbus for wages, salaries and commissions paid to the contractor's employees as well as requiring those contractors to ensure that subcontractors withhold in a like manner.

LOCAL CREDIT: For all contracts EXCEPT PROFESSIONAL SERVICE CONTRACTS: In determining the lowest bid for purpose of awarding a contract not exceeding \$20,000.00, a local bidder shall receive a credit equal to five percent (5%) of the lowest bid submitted by a non-local bidder. In determining the lowest bid for purposes of awarding a contract in excess of \$20,000.00, a local bidder shall receive a credit equal to one percent (1%) or \$10,000.00, whichever is less, of the lowest bid submitted by a non-local bidder. A local bidder is a person, corporation or business which (a) has listed its principal place of business as being located within the corporation limits of the City of Columbus or the County of Franklin in official documents filed with Secretary of State, State of Ohio, or a valid vendor's license which indicates its place of business is located within the corporation limits of the City of Columbus or County of Franklin.

FOR COPIES OF ANY OF THE FOLLOWING BID PROPOSALS CALL THE LISTED DIVISION

THE CITY BULLETIN
BIDS WANTED - PURCHASING OFFICE AND OTHER DIVISIONS

BID OPENING DATE - February 23, 2011 3:00 pm

SA003832 - CIP 650742 Berliner Park Storm & Sanita

THE CITY BULLETIN
BIDS WANTED - PURCHASING OFFICE AND OTHER DIVISIONS

SCOPE: The City of Columbus, Department of Public Utilities, Division of Sewerage and Drainage is receiving proposals for CIP 650742 Berliner Park Storm and Sanitary Sewer Improvements. Sealed Bids will be received by the Director of Public Utilities of the City of Columbus, Ohio, at its office, 910 Dublin Road, Room 4002, until 3:00 p.m. Local Time on Wednesday, February 23, 2011 . They will be publicly opened and read thereafter in the basement Auditorium.

The work for which proposals are invited consists of all labor and materials for the construction of approximately 49 feet of 8-inch sanitary sewer; 50 feet of 6 inch sanitary sewer laterals; 362 feet of 8 inch cured-in-place pipe liner; 19 vf. of cementitious manhole rehabilitation; 4,322 feet of 48 inch pipe filled-in-place with CDF; 1,215 feet of 2-inch diameter sanitary force main by trenchless installation methods; furnishing and installation of 4 grinder package pump stations; 125 feet of 12 inch concrete storm sewer; 300 feet of 15 inch concrete storm sewer; 2,550 feet of linear ditch grading; 2,600 c.y. of earth excavation for creation of infiltration trenches; manhole and catch basin abandonments or removal; driveway and permanent pavement replacement; maintenance of traffic, and other such work as may be necessary to complete the contract in accordance with the plans (CC-15695) and specifications. The project construction limits are within the City of Columbus. All work shall be completed within 608 days.

CLASSIFICATION: Prevailing wage rates apply. A 10% (ten percent) proposal guaranty (proposal bond or certified check) and a 100% (one hundred percent) performance and payment bond are required for this bid. The Contract Documents in paper format (with Plans and Prevailing Wages Packet on CD (Compact Disc)), are on file at the Division of Sewerage and Drainage, Sewer System Engineering Section, Room No. 1021A, 1250 Fairwood Avenue, Columbus, Ohio 43206-3372. The first set is available to prospective bidders at no cost with the second and subsequent sets available at a cost of \$25.00 per set on a no-refund basis. No partial units will be released.

QUESTIONS: All questions regarding this project should be presented by email submittal as soon as possible but no later than the close of business on Wednesday February 16, 2011 to Paul Roseberry, P.E. pbroseberry@columbus.gov . Answers to questions will be given via addenda which will be issued, if necessary, by Friday February 18, 2011.

For additional information concerning this bid, including procedures for obtaining a copy of the bid document(s) and how to submit a proposal, you must go to the City of Columbus Vendor Services web page (<http://vendorservices.columbus.gov>) and view thi
ORIGINAL PUBLISHING DATE: January 25, 2011

SA003842 - GERMAN VILLAGE AREA WATER LINE IMPROVE

THE CITY BULLETIN
BIDS WANTED - PURCHASING OFFICE AND OTHER DIVISIONS

SCOPE: The City of Columbus Department of Public Utilities, Division of Power and Water is receiving proposals for the German Village Area Water Line Improvements project. The work for which proposals are invited consists of the installation approximately 5,300 feet of 6-inch ductile iron water lines and appurtenances, through both open-cut and horizontal directional drilling construction methods, and other such work as may be necessary to complete the contract in accordance with the plans (CIP No. 690236-100010, Contract No. 1126) and specifications. All work shall be completed within 180 days from date of the Notice to Proceed.

CLASSIFICATIONS: There is not a Pre-Bid Conference for this bid. Prevailing wage rates apply. A 10% (ten percent) proposal guaranty (proposal bond or certified check) and a 100% (one hundred percent) performance and payment bond are required for this bid. Plans are available to prospective bidders on or after February 7, 2011. The Bid Date for the project is February 23, 2011.

For additional information concerning this bid, including procedures for obtaining a copy of the bid document(s) and how to submit a proposal, you must go to the City of Columbus Vendor Services web page (<http://vendorservices.columbus.gov>) and view this bid number in the open solicitations listing.

ORIGINAL PUBLISHING DATE: February 15, 2011

SA003845 - R&P Security Cameras & Fire Alarms RFP

THE CITY BULLETIN
BIDS WANTED - PURCHASING OFFICE AND OTHER DIVISIONS

Professional Services
REQUEST FOR PROPOSAL
Columbus Recreation & Parks Department

Proposals will be received at the Columbus Recreation and Parks Department Administrative Office, 1111 E. Broad Street, Columbus, OH 43205, until 4:00 P.M., Wednesday, February 23, 2011 for:

Security Cameras and Fire Alarm System Improvements

Six (6) copies of each proposal are required for submittal.

Consultant shall provide architectural & engineering services to prepare plans and specifications for bidding for Security Camera and Fire Alarm System Improvements to various department facilities. Work is to include adding or improving fire alarm systems to several recreation centers and adding camera security systems to facilities. Services shall include the necessary building inventories and evaluations, program development in conjunction with Department staff, reports, proposals, cost estimates, bid documents and construction administration services.

Project Budget: \$512,000, including consultant fees.

The format for procurement of these services will be per Section 329.12 of the Columbus City Code.

Initial screening will be based on the following criteria:

1. Experience of the Consultant as related to security and fire alarm design.
2. Qualifications of key personnel who will be involved with this project.
3. Quality of work previously performed by the consultant for this Department, other City Agencies and other previous clients.

Interested firms should apply to the Recreation and Parks Department with the following information:

1. Firm name, address, telephone number and contact person.
2. Year established.
3. Types of services for which it is qualified.
4. Names of principals in the firm with professional registrations.
5. Names and experience of key personnel assigned to this project.
6. Outside consultants, if any, who will be used on this project.
7. MBE/FBE participation in the project.
8. List of completed projects of similar nature with contact person for each.
9. City of Columbus Contract Compliance Certification Number or copy of completed application.
10. Estimate of Fee range for the work along with billing rates for the key personnel involved.

RFP Information Packet for this project and plans of the project site are available from 8 A.M. to 5 P.M., Monday through Friday, beginning Monday, February 7, 2011, at the Administrative Office, 1111 E. Broad Street, Columbus, OH 43205.

THE CITY BULLETIN
BIDS WANTED - PURCHASING OFFICE AND OTHER DIVISIONS

All questions regarding the submittal should be directed to Rick Miller, Recreation and Parks Department, 614-645-3385.

All consultants will be subject to the provisions of the City of Columbus, Contract Compliance Program regarding equal employment opportunity.

Clayton Royder, President Alan D. McKnight, Director
Recreation and Parks Commission Recreation and Parks Department

Advertisement Dates: 02/05/2011, 02/12/2011
ORIGINAL PUBLISHING DATE: February 04, 2011

BID OPENING DATE - February 24, 2011 11:00 am

SA003829 - 175 GALLON TURF SPRAYER

1.1 Scope: It is the intent of these specifications to describe a gasoline powered, 175 gallon turf sprayer with an 18.5 foot working width triangular truss open boom for use by the Columbus Municipal Golf Division capable of making liquid spray applications to all golf course areas. This sprayer will be stationed at Walnut Hill Golf Course. All parts not specifically mentioned, which are necessary to provide a complete unit, shall be included in the bid and conform in strength, quality of material and workmanship to what is usually provided to the trade of golf course turf sprayers.

1.2 Classification: Any units not conforming to these specifications may be rejected. It will be the responsibility of the manufacturer to conform to the requirements unless exceptions have been specifically cited by the bidder and acceptance made on the basis of the exceptions. Suppliers must have a servicing dealership capable of providing warranty repairs, post warranty repairs, full parts inventory, and product demonstrations located within 140 miles of the intersection of Broad and High Streets, Columbus, Ohio.

For additional information concerning this bid, including procedures for obtaining a copy of the bid document(s) and how to submit a proposal, you must go to the City of Columbus Vendor Services web page (<http://vendorservices.columbus.gov>) and view this bid number in the open solicitations listing.

ORIGINAL PUBLISHING DATE: January 22, 2011

SA003835 - POLICE/HIGH DENSITY MOVEABLE FILING SYS.

THE CITY BULLETIN
BIDS WANTED - PURCHASING OFFICE AND OTHER DIVISIONS

1.1 Scope: It is the intent of the City of Columbus, Division of Police to purchase a high density moveable filing storage system for the Records Unit.

1.2 Classification: This request is for the installation, purchase, setup of filing system, and maintenance of the complete filing system. The mechanical-assist movable shelving system will be ADA compliant. Ease of use, mechanical shelving and maximum filing space are the essential requirements of this system.

1.2.1 A Pre-bid Conference will be held on Wednesday, February 9, 2011 at 10:00 a.m. in Police Central Headquarters, Third floor conference room, 120 Marconi Blvd., Columbus, OH 43215. All interested bidders are strongly urged to attend, as this is the only opportunity to do a walk-through of this secured building. Failure to attend the Pre-Bid Conference will not disqualify a bidder; however, bidders shall comply with and be responsible for the bid specifications and information discussed at the Pre-Bid Conference. Questions will be received in writing at the Pre-bid Meeting. Responses to questions and results of the Pre-bid meeting will be posted as an addendum on Monday, February 14, 2011 by 4:00 p.m. (EST) via the Columbus Vendor Services web site <http://vendorservices.columbus.gov/e-proc>.

If a proposed equal product is bid, the bid packet shall include brochures with specifications and/or product description sheets identifying all materials and products being bid.

Bidders shall submit diagrams/drawings of their proposed filing systems and total amount of filing space that will be provided.

The City of Columbus, Ohio is looking for suppliers who have been in business for five (5) years and sells, services and warrants High Density Moveable Storage System.

Bidders shall state warranty information on proposal pages and submit copies of all warranties with this bid. During warranty period state your response time for repairs.

The bidder shall submit a certificate stating that the bidder is an authorized dealer and installer representing the manufacturer listed in their bid and this certification must be on the manufacturer's letterhead stationery signed by an officer of the manufacturer's company. The certification shall state the local authorized dealer/installer, including address and telephone number.

For additional information concerning this bid, including procedures for obtaining a copy of the bid document(s) and how to submit a proposal, you must go to the City of Columbus Vendor Services web page (<http://vendorservices.columbus.gov>) and view this bid number in the open solicitations listing.

ORIGINAL PUBLISHING DATE: February 15, 2011

SA003859 - LAND REDVT - LAWN CARE/SNOW REMOVAL LMF

THE CITY BULLETIN
BIDS WANTED - PURCHASING OFFICE AND OTHER DIVISIONS

LAWN CARE/SNOW REMOVAL SERVICES - LAND REDEVELOPMENT OFFICE/LAND BANK PROGRAMS

1.0 SCOPE AND CLASSIFICATION

Scope: It is the intent of the City of Columbus, Department of Development, Land Redevelopment Office, to obtain bids to establish one or more contracts for all labor, materials, and equipment necessary to provide lawn care and snow removal services for the Columbus Land Bank. The Land Bank inventory contains both city owned vacant lots and parcels with structures scattered throughout the City of Columbus. The contract will not be exclusive; the City reserves the right to award contracts to multiple contractors under this bid request. This contract is for the 2011 lawn cutting season and may be extended an additional year, as provided herein.

1.2 Classification:

1.2.1 Proximity: All bidders must demonstrate (by means of providing the information requested herein) the ability and means to respond to the specifications within the response times stated.

For additional information concerning this bid, including procedures for obtaining a copy of the bid document(s) and how to submit a proposal, you must go to the City of Columbus Vendor Services web page (<http://vendorservices.columbus.gov> <<http://vendorservices.columbus.gov/>>) and view this bid number in the open solicitations listing.

ORIGINAL PUBLISHING DATE: February 16, 2011

SA003847 - R&P Broad St Park Development 2011

THE CITY BULLETIN
BIDS WANTED - PURCHASING OFFICE AND OTHER DIVISIONS

ADVERTISEMENT FOR BIDS

Sealed proposals will be received by the Recreation and Parks Commission of the City of Columbus, Ohio, at its office at 1111 E Broad Street, until 11:00 a.m. on Thursday, February 24, 2011, and publicly opened and read immediately thereafter for:

Broad Street Park Development 2011

The work for which proposals are invited consists of earthwork, landscaping, asphalt, concrete, installation of site furnishings, sports field installation, and other such work as may be necessary to complete the contract in accordance with the plans and specifications.

Copies of the Project Manual/Specifications and the plans are on file and available to prospective bidders on 02/07/11 at Atlas Blueprint, 374 W. Spring St., Columbus, Ohio 43215, (614) 224-5149, www.atlasblueprint.com upon a non-refundable payment per bid set. Contact Atlas Blueprint for the cost. Payment shall be made payable to Atlas Blueprint.

Questions about the project should be directed to Justin Loesch @ 614-724-3004 or jdloesch@columbus.gov

Proposals must be submitted on the proper forms, P-1 through P-35, contained in the Project Manual/Specifications. The Proposal section in its entirety must be submitted in a sealed envelope marked "Broad Street Park Development 2011"

ORIGINAL PUBLISHING DATE: February 04, 2011

SA003838 - MMO-MUG TEST MATERIALS UTC

1.1 Scope: The City of Columbus Division of Power and Water is soliciting bids for a Universal Term (Blanket Type) order to supply parts and supplies for testing total coliform bacteria MMO-MUG (method 9223) and E. coli bacteria with Colilert (24-28 hour incubation period) and Colilert-18 (18-22 hr. incubation period) (method 9223-18) to meet Federal and State of Ohio mandated regulations. The City estimates spending annually from this contract \$35,000.00. The contract will be in effect for a period of three (3) years to and including April 30, 2014.

1.2 Classification: The resulting contract will be for the option to purchase and the delivery of listed items on an as needed basis. Specifications detail IDEXX products used in this process and are the only acceptable products as the city is certified by the OEPA for Total Coliform and E. coli by MMO-MUG (method 9223) and Total Coliform and E. coli by Colilert 18 (method 9223-18) testing.

For additional information concerning this bid, including procedures for obtaining a copy of the bid document(s) and how to submit a proposal, you must go to the City of Columbus Vendor Services web page (<http://vendorservices.columbus.gov>) and view this bid number in the open solicitations listing.

ORIGINAL PUBLISHING DATE: February 01, 2011

THE CITY BULLETIN
BIDS WANTED - PURCHASING OFFICE AND OTHER DIVISIONS

SA003837 - OCM-RENOV OF EFFICIENT CH EXT LIGHTING

ADVERTISEMENT FOR BID

RENOVATION FOR ENERGY EFFICIENT EXTERIOR LIGHTING, FOR THE CITY OF COLUMBUS, 90 WEST BROAD STREET, COLUMBUS, OHIO 43215

1.1 Scope: It is the intent of the City of Columbus, Department of Finance and Management, Office of Construction Management, to obtain formal bids to establish a contract for: RENOVATION FOR ENERGY EFFICIENT EXTERIOR LIGHTING, FOR THE CITY OF COLUMBUS, 90 WEST BROAD STREET, COLUMBUS, OHIO 43215 for February 7 thru February 24, 2011.

1.2 Classification: This is a single prime project. There will be a prebid and walk thru at the site on Friday, February 4th at 10:00 a.m. at 90 West Broad Street, Columbus, Ohio 43215 (Front Street entry lobby). This is a prevailing wage project requiring bonding and insurance.

Brief description- (Electrical Trades) removal of existing building exterior lighting and install energy efficient lighting, conduits, wiring, and controls. Total construction estimate is \$240,000.

All questions and concerns pertaining to the drawings or specs shall be directed in writing to: Scott Gray, L.C. LEED AP of Advanced Engineering Consultants (fax or email) prior to Monday, February 21, by 4 PM. Fax (614) 486-4082 Email: scottg@aecmep.com

Printing- Specifications will be available on Thursday, February 3, 2011 at Key Blueprint, 195 E. Livingston Avenue, Columbus, Ohio 43215, (614) 228-3285, for \$50.00 non-refundable fee plus shipping costs.

Addendums will be issued accordingly.

For additional information concerning this bid, including procedures for obtaining a copy of the bid document(s) and how to submit a proposal, you must go to the City of Columbus Vendor Services web page (<http://vendorservices.columbus.gov>) and view this bid number in the open solicitations listing.

ORIGINAL PUBLISHING DATE: January 29, 2011

SA003834 - Resurfacing 2011 Zone 2/Misc Int Imp

THE CITY BULLETIN
BIDS WANTED - PURCHASING OFFICE AND OTHER DIVISIONS

1.1 Scope: The City of Columbus, Department of Public Service, is receiving proposals until 3:00 P.M., February 24, 2011, for RESURFACING - RESURFACING 2011 ZONE 2 AND MISC INTERSECTION IMPROVEMENT - OLENTANGY RIVER ROAD - HENDERSON ROAD TURN LANE, 1674 DRAWER A and 2811 DRAWER E. Proposals are being received at the Department of Public Service, Office of Support Services, 109 N. Front St., Ground Floor, Security Desk, Columbus, OH, 43215. The project has three (3) parts. The purposes are as follows: Part A - Resurfacing and Part B - ADA Curb Ramps (1674 Dr. A): Repairs and resurfaces thirty-four (34) city streets and constructs 394 - ADA curb ramps along those streets. The work consists of milling the existing pavement, overlaying with new asphalt concrete, minor curb replacement, and replacing curb and sidewalk associated with installing ADA wheelchair ramps. Where warranted, the plans also call for areas of full depth pavement repair. Part C - Intersection Improvements - Olentangy River Road at Henderson Road (2811 Dr. E): Constructs a right turn lane from Olentangy River Road (South Bound) onto west Henderson Road (West Bound) and new curbs and curb ramps, and such other work as may be necessary to complete the contract in accordance with the plans and specifications set forth in the Bid Submittal Documents. The Bid Submittal Documents are defined in the City of Columbus Construction and Material Specifications, 2002, as the bound manual which includes the advertisement for bids, special provisions, the proposal forms, proposed guaranty, contract forms, supplemental specifications, standard drawings (if included), and other notices. The work under this contract shall be completed in a manner acceptable to the City by September 15, 2011.

1.2 Classification: Prevailing wage rates apply. The bidder is required to submit a proposal bond in the form provided in the Bid Submittal documents. The amount of the guaranty shall be expressed in dollars and cents or as a percentage of the bid amount, and shall not be less than ten (10) percent of the bid, including all alternates submitted which increases the bid. Each offeror shall submit with its bond an active City of Columbus Contract Compliance Certification Number, or a completed application for certification. Plan sets can be purchased at 109 N. Front St, Room 301 for the non-refundable cost of \$28.00 for a half-size plan set and \$30.00 for a full-size plan set. A pre-bid meeting will be held at 1:30 p.m. on February 2, 2011 at 1800 E. 17th Ave. All questions concerning the project are to be sent to capitalprojects@columbus.gov. The last day to submit questions is February 7, 2011 at 10:00 am. Responses will be posted on the Vendor Services web site as an addendum and an e-mail will be sent to each firm who purchased plans. Phone calls will not be accepted.

For additional information concerning this bid go to the City of Columbus Vendor Services web page (<http://vendorservices.columbus.gov/e-proc/>) and view this solicitation number in the "open solicitations" listing.

Additional information:

It is highly recommended that proposals are hand delivered and not mailed as US Mail is not delivered directly to this building.

ORIGINAL PUBLISHING DATE: February 15, 2011

THE CITY BULLETIN
BIDS WANTED - PURCHASING OFFICE AND OTHER DIVISIONS

SA003843 - Bikeway Development - Hilltop Connector

1.1 Scope: The City of Columbus, Department of Public Service, is receiving proposals until 3:00 P.M., February 24, 2011, for Bikeway Development - Hilltop Connector, CIP NO. 540002-100015, 1653 Drawer A. Proposals are being received at the Department of Public Service, Office of Support Services, 109 N. Front St., Ground Floor, Security Desk, Columbus, OH, 43215. The purpose of the project is to add bike lanes and shared lanes to the Hilltop Area. Roadways throughout the length of the project will be widened to accommodate bike lanes and shared lanes. The project limits are North Eureka Avenue from Westwood Drive north to the City of Columbus boundary and Harper Road from McKinley Avenue west to the City of Columbus boundary, and such other work as may be necessary to complete the contract in accordance with the plans and specifications set forth in the Bid Submittal Documents. The Bid Submittal Documents are defined in the City of Columbus Construction and Material Specifications, 2002, as the bound manual which includes the advertisement for bids, special provisions, the proposal forms, proposed guaranty, contract forms, supplemental specifications, standard drawings (if included), and other notices. The work under this contract shall be completed in a manner acceptable to the City by July 15, 2011.

1.2 Classification: Prevailing wage rates apply. The bidder is required to submit a proposal bond in the form provided in the Bid Submittal documents. The amount of the guaranty shall be expressed in dollars and cents or as a percentage of the bid amount, and shall not be less than ten (10) percent of the bid, including all alternates submitted which increases the bid. Each offeror shall submit with its bond an active City of Columbus Contract Compliance Certification Number, or a completed application for certification. Half sized plans can be purchased at 109 N. Front St, Room 301 for the non-refundable cost of \$7.00. A pre-bid meeting will not be held. All questions concerning the project are to be sent to capitalprojects@columbus.gov. The last day to submit questions is February 15, 2011 at 10:00 am. Responses will be posted on the Vendor Services web site as an addendum and an e-mail will be sent to each firm who purchased plans. Phone calls will not be accepted.

For additional information concerning this bid go to the City of Columbus Vendor Services web page (<http://vendorservices.columbus.gov/e-proc/>) and view this solicitation number in the "open solicitations" listing.

Additional information:

It is highly recommended that proposals are hand delivered and not mailed as US Mail is not delivered directly to this building.

ORIGINAL PUBLISHING DATE: February 08, 2011

SA003848 - BUTTLES AVENUE GATEWAY

THE CITY BULLETIN
BIDS WANTED - PURCHASING OFFICE AND OTHER DIVISIONS

1.1 Scope: The City of Columbus, Department of Public Service, is receiving proposals until 3:00 P.M., February 24, 2011, for Buttles Avenue Gateway, CIP NO. 530058-100003, 1678 Drawer A. Proposals are being received at the Department of Public Service, Office of Support Services, 109 N. Front St., Ground Floor, Security Desk, Columbus, OH, 43215. The purpose of the project is the fabrication and installation of tree guards and planters on the sidewalk along the north and south sides of Buttles Avenue between Wall and High Streets, and such other work as may be necessary to complete the contract in accordance with the plans and specifications set forth in the Bid Submittal Documents. The Bid Submittal Documents are defined in the City of Columbus Construction and Material Specifications, 2002, as 'the bound manual which includes the advertisement for bids, special provisions, the proposal forms, proposed guaranty, contract forms, supplemental specifications, standard drawings (if included), and other notices.' The work under this contract shall be completed in a manner acceptable to the City by August 31, 2011.

1.2 Classification: Prevailing wage rates apply. The bidder is required to submit a proposal bond in the form provided in the Bid Submittal documents. The amount of the guaranty shall be expressed in dollars and cents or as a percentage of the bid amount, and shall not be less than ten (10) percent of the bid, including all alternates submitted which increases the bid. Each offeror shall submit with its bond an active City of Columbus Contract Compliance Certification Number, or a completed application for certification. Plan sets can be purchased at 109 N. Front St, Room 301 for \$7.00. A pre-bid meeting will not be held. All questions concerning the project are to be sent to capitalprojects@columbus.gov. The last day to submit questions is February 15, 2011 at 10:00 am. Responses will be posted on the Vendor Services web site as an addendum and an e-mail will be sent to each firm who purchased plans. Phone calls will not be accepted.

For additional information concerning this bid go to the City of Columbus Vendor Services web page (<http://vendorservices.columbus.gov/e-proc/>) and view this solicitation number in the 'open solicitations' listing.

Additional information:

It is highly recommended that proposals are hand delivered and not mailed as US Mail is not delivered directly to this building.

ORIGINAL PUBLISHING DATE: February 08, 2011

BID OPENING DATE - March 2, 2011 12:00 pm

SA003858 - ELECTRICAL SERVICES BID FOR FMD

THE CITY BULLETIN
BIDS WANTED - PURCHASING OFFICE AND OTHER DIVISIONS

1.1 Scope: It is the intent of the City of Columbus, Department of Finance and Management, Division of Facilities Management, to obtain a bid proposal to establish a contract for ELECTRICAL SERVICES FOR VARIOUS BUILDINGS UNDER THE PURVIEW OF THE FACILITIES MANAGEMENT DIVISION.

Classification: Contractor shall be licensed, experienced, (bonded) and insured for all work. A pre-bid meeting will be scheduled for WEDNESDAY, FEBRUARY 23, 2011 AT 9:00 a.m. the 640 W. NATIONWIDE BLVD, Second Floor Conference Room, Columbus, Ohio 43215. All questions and concerns pertaining to the specifications shall be directed in writing to Janet Walsh, Building Maintenance Manager at jlwalsh@columbus.gov prior to Friday, February 25, 2011 by 12:00 p.m. Addendums will be issued accordingly. The budget estimate is \$10,000+. Bids are to be returned, Wednesday, March 2, 2011 by 12:00 p.m. to 640 West Nationwide Blvd, first floor office, Columbus, Ohio 43215.

For additional information concerning this bid, including procedures for obtaining a copy of the bid document(s) and how to submit a proposal, you must go to the City of Columbus Vendor Services web page (<http://vendorservices.columbus.gov> <<http://vendorservices.columbus.gov/>>) and view this bid number in the open solicitations listing.

ORIGINAL PUBLISHING DATE: February 15, 2011

BID OPENING DATE - March 3, 2011 11:00 am

SA003850 - ION CHROMATOGRAPHY SYSTEM

1.1 Scope: The Water Quality Assurance Laboratory, Division of Power and Water, is soliciting bids for an Ion Chromatography System of equal or greater quality than the Dionex ICS-2100 system with the Chromeleon7 chromatography data system.

1.2 Classification The contractor will be responsible for supplying two Ion Chromatographs, one Auto Sampler, one Chromeleon7 chromatography data system PC workstation with supporting software and licenses, parts and consumables. The system must be capable of analyzing drinking water samples for both anions and cations. The instrument must meet USEPA method 300.1 specifications for OEPA certification. The contractor will provide product installation and familiarization including: instrument connection, interface, functional confirmation, and on-site customer training.

For additional information concerning this bid, including procedures for obtaining a copy of the bid document(s) and how to submit a proposal, you must go to the City of Columbus Vendor Services web page (<http://vendorservices.columbus.gov>) and view this bid number in the open solicitations listing.

ORIGINAL PUBLISHING DATE: February 05, 2011

THE CITY BULLETIN
BIDS WANTED - PURCHASING OFFICE AND OTHER DIVISIONS

SA003846 - PUBLIC SERVICE/POTHOLE PATCHER TRUCKS

1.1 Scope: It is the intent of the City of Columbus, Public Service Department / Division of Planning and Operations to obtain formal bids to establish a contract for the purchase and delivery of two (2) Pothole Patcher Trucks. The Pothole Patcher Trucks will be used by the Street Maintenance Operations Section of the Division of Planning and Operations in street maintenance and repairs operations.

1.2 Classification: The contract resulting from this bid proposal will provide for the purchase and delivery of two (2) new and unused Pothole Patcher Trucks.

For additional information concerning this bid, including procedures for obtaining a copy of the bid document(s) and how to submit a proposal, you must go to the City of Columbus Vendor Services web page (<http://vendorservices.columbus.gov>) and view this bid number in the open solicitations listing.

ORIGINAL PUBLISHING DATE: February 16, 2011

SA003841 - Allis Chalmers Sludge Pump Repair Parts

1.1 Scope: It is the intent of the City of Columbus, Division of Power & Water to obtain formal bids to establish a Universal Term Contract for the purchase of Allis Chalmers Sludge Pump Parts. The City of Columbus estimates spending \$40,000.00 annually for this contract. The contract will be in effect from the date of execution by the City to and including April 30, 2013.

1.2 Classification: The contract resulting from this proposal will provide for the purchase and delivery of replacement parts for Allis Chalmers Sludge Pumps. The pump models currently in use are listed herein, and bidders are asked to bid on commonly purchased replacement parts for those pumps, as identified. In addition, bidders are asked to bid a list price discount for replacement/repair parts for the pump models listed in the specifications, and to supply pricing lists for standard replacement parts for the models mentioned.

For additional information concerning this bid, including procedures for obtaining a copy of the bid document(s) and how to submit a proposal, you must go to the City of Columbus Vendor Services web page (<http://vendorservices.columbus.gov>) and view this bid number in the open solicitations listing.

ORIGINAL PUBLISHING DATE: February 02, 2011

SA003849 - OCM-INSTALLATION OF WATER WELLS

THE CITY BULLETIN
BIDS WANTED - PURCHASING OFFICE AND OTHER DIVISIONS

ADVERTISEMENT FOR BIDS

INSTALLATION OF WATER WELLS, FOR THE CITY OF COLUMBUS,
AT 90 WEST BROAD STREET AND 120 WEST GAY STREET,
COLUMBUS, OHIO 43215

1.1 Scope: It is the intent of the City of Columbus, Department of Finance and Management, Office of Construction Management, to obtain formal bids to establish a contract for: ?INSTALLATION OF WATER WELLS, FOR THE CITY OF COLUMBUS, AT 90 WEST BROAD STREET AND 120 WEST GAY STREET, COLUMBUS, OHIO 43215? for February 14 thru March 3, 2011.

1.2 Classification: This is a single prime project. There will be a prebid and walk thru at the site on Monday, February 14th at 10 AM at 90 West Broad Street, Columbus, Ohio 43215 (corner of Marconi Blvd & Gay Street. Parking will not be provided). This is a prevailing wage project requiring bonding and insurance.

Brief description- Installation of a total of four water wells with associated testing. It is the City?s intent that the installations and testing be completed in May 2011. Total construction estimate is \$200,000.

Printing- Specifications will be available on Friday, February 11, 2011 at 90 West Broad Street, Room B-41, Columbus, Ohio 43215. No cost for the first set. Additional sets available for \$25.00. Addendums will be issued accordingly.

All questions and concerns pertaining to the drawings or specs shall be directed in writing to: Advanced Engineering Consultants , Attention: Benjamin J. Biada, PE, LEED AP (fax (614) 486-4082 or Email: BenB@aecmep.com only) prior to Monday, February 21 2011 , by 4 PM.

For additional information concerning this bid, including procedures for obtaining a copy of the bid document(s) and how to submit a proposal, you must go to the City of Columbus Vendor Services web page (<http://vendorservices.columbus.gov>) and view this bid number in the open solicitations listing.
ORIGINAL PUBLISHING DATE: February 05, 2011

BID OPENING DATE - March 10, 2011 11:00 am

SA003844 - POLICE/S.W.A.T.EQUIPMENT SUPPORT VEHICLE

THE CITY BULLETIN
BIDS WANTED - PURCHASING OFFICE AND OTHER DIVISIONS

1.1 Scope: It is the intent of the City of Columbus, Division of Police to obtain formal bids to establish a contract for the purchase of one (1) Police Specialty S.W.A.T. Equipment / Support Vehicle.

1.2 Classification: The contract(s) resulting from this bid proposal will provide for the purchase and delivery of one (1) new and unused Police Specialty S.W.A.T. Equipment / Support Vehicle. Prior to February 18, 2011 at 8:00a.m., send questions to: <mailto:vendorservices@columbus.gov> / subject line: SA003844. Answers will be posted as an addendum at this site by February 25, 2011 at 5:00p.m...Vendor must meet qualifications as stated in bid and have a service location located in Franklin County or continuous county.

For additional information concerning this bid, including procedures for obtaining a copy of the bid document(s) and how to submit a proposal, you must go to the City of Columbus Vendor Services web page (<http://vendorservices.columbus.gov>) and view this bid number in the open solicitations listing.

ORIGINAL PUBLISHING DATE: February 03, 2011

SA003851 - OCM-RENOV OF BLDG EXT @ 1111 E BROAD ST

THE CITY BULLETIN
BIDS WANTED - PURCHASING OFFICE AND OTHER DIVISIONS

ADVERTISEMENT FOR BIDS

RENOVATION OF THE BUILDING EXTERIOR FOR THE CITY OF COLUMBUS, AT 1111 EAST BROAD STREET, COLUMBUS, OHIO 43205

1.1 Scope: It is the intent of the City of Columbus, Department of Finance and Management, Office of Construction Management, to obtain formal bids to establish a contract for: RENOVATION OF THE BUILDING EXTERIOR FOR THE CITY OF COLUMBUS, AT 1111 EAST BROAD STREET, COLUMBUS, OHIO 43205, for Feb 17 thru March 10, 2011.

1.2 Classification: This is a single prime project. There will be a prebid and walk thru at the site (north entry) on Thursday, February 17th at 1 PM. This is a prevailing wage project requiring bonding and insurance.

Brief description- renovation of the exterior of the building to include: masonry and stone cleaning, masonry repairs, belt coarse flashing repairs, marble & railing repairs, resetting of marble treads at front entry, caulking, gutter repairs and debris removal, painting, loading dock renovations, and repair & replacement of clay roof tiles. Total construction budget is \$180,000.

All questions and concerns pertaining to the drawings or specs shall be directed in writing to: ATTN: Peter E. Masteller, Assoc. AIA of Harris Architects via Fax (614) 985-1194 or email: pmasteller@harrisaia.com ONLY prior to Monday, March 7, 2011 by noon.

Printing- Specifications will be available on Monday, February 14th, at Key Blueprint, 195 E. Livingston Avenue, Columbus, Ohio 43215, (614) 228-3285, for a non-refundable \$65.00 fee plus shipping costs. Addendums will be issued accordingly.

For additional information concerning this bid, including procedures for obtaining a copy of the bid document(s) and how to submit a proposal, you must go to the City of Columbus Vendor Services web page (<http://vendorservices.columbus.gov>) and view this bid number in the open solicitations listing.
ORIGINAL PUBLISHING DATE: February 08, 2011

SA003854 - PED SAFETY IMP - OBETZ ROAD SIDEWALKS

THE CITY BULLETIN
BIDS WANTED - PURCHASING OFFICE AND OTHER DIVISIONS

1.1 Scope: The City of Columbus, Department of Public Service, is receiving proposals until 3:00 P.M., March 10, 2011, for PEDSTRIAN SAFETY IMPROVEMENTS - OBETZ ROAD SIDEWALKS, CIP NO. 590105-100031, 1679 Drawer A. Proposals are being received at the Department of Public Service, Office of Support Services, 109 N. Front St., Ground Floor, Security Desk, Columbus, OH, 43215. The purpose of the project is; to construct 2,662 linear feet of sidewalk on Obetz Road between South High St. and Beth Ann Drive, to replace existing drives as indicated on the plans, to remove and replace existing pavement at the Obetz Road and High Street intersection and reconstruct curb ramps, miscellaneous drainage improvements, and such other work as may be necessary to complete the contract in accordance with the plans and specifications set forth in the Bid Submittal Documents. The Bid Submittal Documents are defined in the City of Columbus Construction and Material Specifications, 2002, as "the bound manual which includes the advertisement for bids, special provisions, the proposal forms, proposed guaranty, contract forms, supplemental specifications, standard drawings (if included), and other notices." The work under this contract shall be completed in a manner acceptable to the City by July 26, 2011.

1.2 Classification: Prevailing wage rates apply. The bidder is required to submit a proposal bond in the form provided in the Bid Submittal documents. The amount of the guaranty shall be expressed in dollars and cents or as a percentage of the bid amount, and shall not be less than ten (10) percent of the bid, including all alternates submitted which increases the bid. Each offeror shall submit with its bond an active City of Columbus Contract Compliance Certification Number, or a completed application for certification. Half sized plan sets can be purchased at 109 N. Front St, Room 301 for \$9.00. A pre-bid meeting will be held at 10:00 a.m. on February 23, 2011 at 1800 E. 17th Ave. All questions concerning the project are to be sent to capitalprojects@columbus.gov. The last day to submit questions is March 1, 2011 at 10:00 am. Responses will be posted on the Vendor Services web site as an addendum and an e-mail will be sent to each firm who purchased plans. Phone calls will not be accepted.

For additional information concerning this bid go to the City of Columbus Vendor Services web page (<http://vendorservices.columbus.gov/e-proc/>) and view this solicitation number in the "open solicitations" listing.

Additional information:

It is highly recommended that proposals are hand delivered and not mailed as US Mail is not delivered directly to this building.

ORIGINAL PUBLISHING DATE: February 12, 2011

BID OPENING DATE - March 11, 2011 11:00 am

SA003863 - E-GOVERNMENT PROFESSIONAL SVCS RFP

THE CITY BULLETIN
BIDS WANTED - PURCHASING OFFICE AND OTHER DIVISIONS

1.1 Scope: It is the intent of the City of Columbus, Department of Technology to obtain formal bids to establish a contract for the purchase of professional services to support DoT eGovernment projects and initiatives for use within the City of Columbus, Department of Technology.

1.2 Classification: This staff augmentation request is in the form of an RFP. The City anticipates awarding to multiple vendors, therefore offerors may respond to all or any portion of the classifications listed in the RFP.

For additional information concerning this bid, including procedures for obtaining a copy of the bid document(s) and how to submit a proposal, you must go to the City of Columbus Vendor Services web page (<http://vendorservices.columbus.gov>) and view this bid number in the open solicitations listing.

ORIGINAL PUBLISHING DATE: February 17, 2011

BID OPENING DATE - March 16, 2011 3:00 pm

SA003855 - Land Application of Biosolids Program

THE CITY BULLETIN
BIDS WANTED - PURCHASING OFFICE AND OTHER DIVISIONS

DIRECTORS INVITATION TO BID pursuant to City Ordinance 329.06(b): LA 2011

LAND APPLICATION OF BIOSOLIDS PROGRAM FOR SEWERAGE AND DRAINAGE FACILITIES

BID OPENING: Sealed Bids will be received by the Director of Public Utilities of the City of Columbus, Ohio, at its office, 910 Dublin Road, Room 4002, until 3:00 p.m. Local Time on Wednesday, March 16, 2011. They will be publicly opened and read thereafter in the basement Auditorium.

TERM: Contract is for one year with two (2) options to renew for one additional year. Contract doesn't automatically renew.

SCOPE: The City of Columbus is requesting bids for biosolids land application services including but not limited to acquiring farmland permits for biosolids application, hauling and injection of biosolids into the soil on cropland, pumping and cleaning anaerobic digesters, and hauling dewatered biosolids cake and incinerator ash to landfills. All work must be performed in accordance with the provisions, specifications, and bidders submittals included and referenced in the project manual.

MINIMUM QUALIFICATIONS: Contractor will have at least four (4) years experience managing biosolids distribution to land at agronomic rates with projects exceeding 5,000 dry tons / year and a single project of at least 10 million gallons/year. Contractor will have on staff a Certified Agronomist with experience permitting cropland for land application and directing field work and record keeping in compliance with State and Federal regulations. Contractor shall provide references with name, address; phone number of contact person for whom work was performed.

EXAMINATION AND PROCUREMENT OF DOCUMENTS:

Bidding Documents may be examined or purchased at the following locations:
Division of Sewerage and Drainage, SW Compost Facility, 7000 Jackson Pike, Lockbourne, Ohio 43137.
Copies of the Bidding Document packet cost is \$50 per set, no refunds will be made. Checks shall be made payable to Treasurer City of Columbus or you may download the documents on the website
<http://vendorservices.columbus.gov>

A Proposal Bond or check in the amount of not less than 10% of the bidders maximum bid price must accompany each bid. A Contract Performance and Payment Bond of 100% of the amount of the contract is required upon award.

NOTE: There are three (3) closely related concurrent projects being advertised 2/11/11:
IFB - Land Application of Biosolids Program; RFP- Innovative Reuse of Biosolids; and RFP - Land Application of Biosolids with Regional Storage.

For additional information concerning this bid, including procedures for obtaining a copy of the bid document(s) and how to submit a proposal, you must go to the City of Columbus Vendor Services web page (<http://vendorservices.columbus.gov>) and view this bid number in the open solicitations listing.

ORIGINAL PUBLISHING DATE: February 15, 2011

BID OPENING DATE - March 17, 2011 11:00 am

THE CITY BULLETIN
BIDS WANTED - PURCHASING OFFICE AND OTHER DIVISIONS

SA003852 - PEST CONTROL SERVICES UTC

1.1 Scope: The City of Columbus is soliciting bid proposals for Pest Control services. It is the intent of this proposal to establish a Universal Term Contract to be used by various City agencies for all City of Columbus buildings to provide insect and pest control services for various City of Columbus buildings. These services shall include, but not be limited to, the control of rats, mice, roaches, ants, silverfish, crickets, centipedes, water bugs, and fleas. It is estimated the City will spend \$65,000.00 annually. This contract will extend through May 31, 2013.

1.2 Classification: The Contractor shall furnish all labor, materials, supervision, equipment, services, and related items necessary to accomplish the full treatment pest control service for all areas and buildings specified herein and in accordance with this specification and scope of work. Areas to be treated include, but are not limited to, all common areas including hallways, stairwells, public rest rooms, offices, recreation areas, kitchens, laundry rooms, garbage rooms, stock rooms, workshops, closets, basements, laboratories, and the exterior perimeter of the first floor of all buildings.

1.2.1 Experience and ability: All bidders must demonstrate (by means of providing the information requested herein) the ability and means to respond to the specifications within the response times and in compliance with the specifications stated herein.

1.2.2 Bid Structure: Bidders are requested to submit pricing for various locations divided into three sections (based on billing agencies) within the City. Bidders are requested to per location pricing for areas specified and square footage pricing for future additional locations. Bidders may bid on any or all zones, but each zone bid must be bid in its entirety.

For additional information concerning this bid, including procedures for obtaining a copy of the bid document(s) and how to submit a proposal, you must go to the City of Columbus Vendor Services web page (<http://vendorservices.columbus.gov>) and view this bid number in the open solicitations listing.

ORIGINAL PUBLISHING DATE: February 11, 2011

SA003862 - ASSET, INVENTORY & WORK ORDER SYSTEM RFP

THE CITY BULLETIN
BIDS WANTED - PURCHASING OFFICE AND OTHER DIVISIONS

Scope: The City of Columbus, Department of Finance and Management is seeking proposals to provide the City with a computerized data system (System) to better track inventory, assets, service requests and work orders in order to improve service responsiveness and speed and to reduce costs. Offerors are encouraged to submit proposals that demonstrate their competence, ability, past performance, quality and feasibility, cost, and environmental impact as defined in this request. The City may contract with one or more Offerors chosen through this RFP process. Offerors may submit proposals for inventory, asset, service request and work order systems as an enterprise product or as individual solutions as outlined in this RFP.

Classification: Qualified suppliers must submit (as described within the specifications) documentation of a minimum of three (3) successful similar installations. This request targets approximately 185 field employees, 40 office employees, 20,000 individual assets, 10 inventory storerooms and 40,000 annual work orders.

Specification Questions: Questions regarding this bid must be sent by in writing via email to vendorservices@columbus.gov no later than 11:00 a.m. (local time) on February 28, 2011. Responses will be posted as an addendum to this bid on the City's website (vendorservices.columbus.gov) no later than 11:00 a.m. (local time) on March 3, 2011. See section 3.2.2.1 for additional details.

For additional information concerning this bid, including procedures for obtaining a copy of the bid document(s) and how to submit a proposal, you must go to the City of Columbus Vendor Services web page (<http://vendorservices.columbus.gov>) and view this bid number in the open solicitations listing.

ORIGINAL PUBLISHING DATE: February 17, 2011

SA003853 - Geologic Borings & Well Abandonment

THE CITY BULLETIN
BIDS WANTED - PURCHASING OFFICE AND OTHER DIVISIONS

1.1 Scope: The City of Columbus, Division of Water, Parsons Avenue Water Plant is obtaining bids to establish an option contract for approximately fifteen (15) subsurface geologic investigations (borings), installation of approximately fifteen (15) monitoring wells, and the abandonment of approximately ten (10) monitoring wells within the southern Central Ohio area. The purpose of the drilling is to obtain geologic information and/or monitoring well installations from various boring locations. The term of the resulting contract would be approx. two and one half (2-1/2) years, through December 31, 2013.

1.2 Classification: Geologic investigation borings will be performed via the Hollow Stem Auger (HSA) drilling method or Rotasonic techniques, though cable tool drilling may be required. Monitoring well installations will also be performed primarily via the HSA drilling method or Rotasonic techniques. The Contractor will be required to provide and install, as specified herein, all materials essential for the proper installation of monitoring well(s) and protective covering(s). Sampling of the subsurface geologic formations will occur every five (5) feet for HSA and cable tool drilling. Rotasonic holes will be sampled continuously. A complete boring log will be submitted to the City at the completion of each boring. The Contractor will also be required to provide all materials necessary to complete the abandonment of monitoring wells.

For additional information concerning this bid, including procedures for obtaining a copy of the bid document(s) and how to submit a proposal, you must go to the City of Columbus Vendor Services web page (<http://vendorservices.columbus.gov>) and view this bid number in the open solicitations listing.

ORIGINAL PUBLISHING DATE: February 12, 2011

BID OPENING DATE - April 15, 2011 2:00 pm

SA003856 - RFP - Innovative Reuse of Biosolids

THE CITY BULLETIN
BIDS WANTED - PURCHASING OFFICE AND OTHER DIVISIONS

REQUEST FOR PROPOSAL

Columbus Department of Public Utilities Request for Proposals for: "INNOVATIVE REUSE OF BIOSOLIDS" will be received by: the Director of Public Utilities, 910 Dublin Road, 4th Floor, Room 4002, Columbus, Ohio 43215 until 2:00 p.m. Local Time on Friday, April 15, 2011. They will be publicly opened and the names of the companies read thereafter in the basement Auditorium.

The format for procurement of these services will be per Section 329.14 of the Columbus City Code.

Five (5) copies of each proposal are required for submittal.

SCOPE of WORK: Consultant shall provide professional biosolids management services to develop and implement innovative biosolids reuse programs. The City is interested in reducing a portion of the 25,000 dry tons of digested biosolids incinerated or landfilled annually with one or more programs that beneficially utilize the biosolids on land. It is the intention that the Contractor distribute, over at least a five-year period, a quantity of biosolids up to an estimated 25,000 DT/yr (about 100,000 WT/yr as cake), for soil improvement, mine or disturbed land reclamation, brown field restoration, and other beneficial purposes, with or without additional processing prior to use. Projects may be multi-year, but must be completely implemented within the five year term of this contract. The minimum annual project size is 4,000 DT.

MINIMUM QUALIFICATIONS

Contractor has at least two (2) years experience managing innovative reuse of biosolids. Contractor shall provide references with name, address; phone number of contact person for whom work was performed. Contractor will have managed at least 10,000 tons of recycled organics (biosolids, manure, food waste, yardwaste, etc.) per year for 5 years including work related to collection, treatment, product development and marketing of finished product.

Interested firms should apply to the Public Utilities Department, with the following information:

1. Firm name, address, telephone number and contact person.
2. Year established.
3. Clearly state how the Offeror meets Minimum Qualifications.
4. Names of principals in the firm with professional registrations.
5. Names and experience of key personnel assigned to this project.
6. Outside consultants, if any, who will be used on this project.
7. MBE/FBE participation in the project.
8. List of completed projects of similar nature with contact person for each.
9. City of Columbus Contract Compliance Certification Number or copy of completed application.

An RFP Information Packet for this project are available from 7 A.M. to 4 P.M., Monday through Friday, beginning Friday February 11, 2011, at the SW Compost Facility, 7000 Jackson Pike, Lockbourne, Ohio 43137. Or you may download the documents on the website <http://vendorservices.columbus.gov>

All questions regarding the submittal should be directed to John Hoff, Division of Sewerage and Drainage, SW Compost Facility 614-645-3153 x102.

THE CITY BULLETIN
BIDS WANTED - PURCHASING OFFICE AND OTHER DIVISIONS

NOTE: There are three (3) closely related concurrent projects being advertised 2/11/11:
IFB - Land Application of Biosolids Program; RFP- Innovative Reuse of Biosolids; and RFP - Land Application of Biosolids with Regional Storage.

All Offerors will be subject to the provisions of the City of Columbus, Contract Compliance Program regarding equal employment opportunity.

For additional information concerning this bid, including procedures for obtaining a copy of the bid document(s) and how to submit a proposal, you must go to the City of Columbus Vendor Services web page (<http://vendorservices.columbus.gov>) and view this bid number in the open solicitations listing.
ORIGINAL PUBLISHING DATE: February 15, 2011

SA003857 - RFP-Land App of Biosolids w/Reg Storage

THE CITY BULLETIN
BIDS WANTED - PURCHASING OFFICE AND OTHER DIVISIONS

REQUEST FOR PROPOSAL

Columbus Department of Public Utilities Request for Proposals for: "LAND APPLICATION OF BIOSOLIDS WITH REGIONAL STORAGE" will be received by: the Director of Public Utilities, 4th Floor, Room 4002, 910 Dublin Road, Columbus, Ohio 43215 until 2:00 p.m. Local Time on Friday, April 15, 2011. They will be publicly opened and read thereafter in the basement Auditorium.

Five (5) copies of each proposal are required for submittal.

SCOPE of WORK: Consultant shall provide professional biosolids management services to design / build / and operate (DBO) regional liquid biosolids storage facilities and land application of biosolids. The contractor would use the storage to stage biosolids near the farm fields prior to land application. The contractor would then apply the biosolids to the farm fields through liquid injection. The city has limited liquid biosolids storage facilities at the wastewater treatment plant and is plans to expand its current land application program through the use of regional storage.

The format for procurement of these services will be per Section 329.14 of the Columbus City Code.

MINIMUM QUALIFICATIONS

1. The Team must demonstrate experience with design, permitting new facilities, construction, and operation of facilities for biosolids treatment and land application for a single project greater than 15 million gallons per year (approximately 7,000 dt/yr).
2. Contractor has on staff a Project Superintendent with at least five (5) years experience land applying liquid sludge at agronomic rates, and at least two (2) years experience of subsurface injection of sludge. Project Superintendent shall provide references to show project management experience of land application of at least 10,000 dry tons of biosolids and a project of at least 5,000 dry tons / year. Contractor shall provide references with name, address; phone number of contact person for who work was performed.
3. Contractor has at least four (4) years experience managing biosolids treatment and distribution to land at agronomic rates. Contractor shall provide references with name, address; phone number of contact person for whom work was performed.

Interested firms should apply to the Public Utilities Department with the following information:

1. Firm name, address, telephone number and contact person.
2. Year established.
3. Clearly state how the Offeror meets Minimum Qualifications.
4. Names of principals in the firm with professional registrations.
5. Names and experience of key personnel assigned to this project.
6. Outside consultants, if any, who will be used on this project.
7. MBE/FBE participation in the project.
8. List of completed projects of similar nature with contact person for each.
9. City of Columbus Contract Compliance Certification Number or copy of completed application.

An RFP Information Packet for this project are available from 7 A.M. to 4 P.M., Monday through Friday, beginning Friday February 11, 2011, at the SW Compost Facility, 7000 Jackson Pike, Lockbourne, Ohio 43137 or you may download the documents on the website <http://vendorservices.columbus.gov>

All questions regarding the submittal should be directed to John Hoff, Division of Sewerage and Drainage,

THE CITY BULLETIN
BIDS WANTED - PURCHASING OFFICE AND OTHER DIVISIONS

SW Compost Facility 614-645-3153 x102.

NOTE: There are three (3) closely related concurrent projects being advertised 2/11/11:

IFB - Land Application of Biosolids Program; RFP- Innovative Reuse of Biosolids; and RFP - Land Application of Biosolids with Regional Storage.

All Offerors will be subject to the provisions of the City of Columbus, Contract Compliance Program regarding equal employment opportunity.

For additional information concerning this bid, including procedures for obtaining a copy of the bid document(s) and how to submit a proposal, you must go to the City of Columbus Vendor Services web page (<http://vendorservices.columbus.gov>) and view this bid number in the open solicitations listing.

ORIGINAL PUBLISHING DATE: February 15, 2011

Public Notices

The link to the **Columbus City Health Code** pdf shall constitute publication in the City Bulletin of changes to the Columbus City Health Department's Health Code. To go to the Columbus City Health Code, click [here](#) (pdf).

The Columbus City Code's "**Title 7 -- Health Code**" is separate from the Columbus City Health Code. Changes to "Title 7 -- Health Code" are published in the City Bulletin. To go to the Columbus City Code's "Title 7 -- Health Code," click [here](#) (html).

**City of Columbus
City Bulletin Report**

Office of City Clerk
90 West Broad Street
Columbus OH 43215-9015
columbuscitycouncil.org

Legislation Number: 20110216142906

Drafting Date: 02/16/2011

Current Status: Clerk's Office for Bulletin

Version: 1

Matter Type: Public Notice

Title

Notice/Advertisement Title: Public Utilities Notice: Department of Public Utilities - Industrial Wastewater Discharge Permits

Contact Name: Jeffrey L. Bertacchi

Contact Telephone Number: (614) 645-5876

Contact Email Address: jlb@columbus.gov

Body

The Administrator of the Division of Sewerage and Drainage announces intent to issue an Industrial Wastewater Discharge Permit to the following company(s) on or about Monday, March 21, 2011: Mauser Corporation, 1410 Blatt Blvd., Gahanna, Ohio 43230

The Draft Permit will be available for review, Monday through Friday, between the hours of 7:30 A.M. and 4:30 P.M., February 22, 2011 through March 14, 2011 at the City of Columbus Industrial Wastewater Pretreatment Office, 1250 Fairwood Avenue, Suite 186, Columbus, Ohio 43206. Written comments will be accepted during this period at the above address or by FAX at (614) 645-0227. This Notice is made according to Columbus City Code Chapter 1145.44(B).

Legislation Number: PN0006-2011

Drafting Date: 01/10/2011

Current Status: Clerk's Office for Bulletin

Version: 1

Matter Type: Public Notice

Title

Notice/Advertisement Title:Accountability Committee Meeting Notice

Contact Name: Jane Dunham, Deputy Finance Director

Contact Telephone Number: 645-8059

Contact Email Address:jadunham@columbus.gov

Body

Mayor Michael B. Coleman and Columbus City Council President Andrew J. Ginther have convened the Committee, with Thomas Hoaglin as the chair. The committee is charged with monitoring the progress of the Columbus 10-Year Reform and Efficiency Action Plan. The Columbus Reform Accountability Committee will hold its next meeting on February 25, 2011 from 2pm-5pm. The meeting will be held in the Buckeye Room of the Jerry Hammond Center, located at 1111 East Broad Street, Columbus, OH 43205. Parking is available on the West side of the building. The Buckeye Room can be accessed from the North entrance of the building.

Legislation Number: PN0016-2011

Drafting Date: 01/27/2011

Current Status: Clerk's Office for Bulletin

Version: 1

Matter Type: Public Notice

Title

Notice/Advertisement Title: Livingston Avenue Area Commission Vacancy Notice

Contact Name: Bonita Lee

Contact Telephone Number: 645-7964

Contact Email Address: btleec@columbus.gov

Body

Livingston Avenue Area Commission
Official Notice of Vacancy
January 26, 2011

In accordance with the bylaws of the Livingston Avenue Area Commission (LAVA-C), this is a communication notifying the public of the vacancy of one position on the area commission.

The remaining term of office is: 1/1/11 - 12/31/11. The applicant awarded the position would, if interested in running for an additional term will be required to seek re-election during the Commission's November 2011 general election.

For those interested in filling the position, please submit a typed resume that list at least **five (5)** years of activity to:

Livingston Avenue Area Commission
c/o Michael Aaron

P.O. Box 6628

Columbus, OH 43206-6628

Resumes must be received by Monday, February 21, 2011.

Candidates must be in attendance at the February 22, 2011 General

Commission Meeting where they will be required to verbally inform the commission and public of their qualifications.

Meeting location: *St. John's Learning Center*

640 S. Ohio Avenue, Cols., OH 43205

Meeting begins at 6:30 p.m.

- Must be 18 years of age or older
- Must be a resident of Livingston Ave. Area Commission area for at least 30 days prior to applying
- Must be registered to vote in Franklin County

--

The Livingston Avenue Area Commission

City of Columbus

PO Box 6628

Columbus, OH 43206

www.livingstonave.com <<http://www.livingstonave.com>>

Notice: This e-mail message, together with any attachments, contains information of the Livingston Avenue Area Commission, and is intended solely for the use of the individual or entity named on this message. If you are not the intended recipient, and have received this message in error, please immediately return this message via e-mail and then delete it.

Legislation Number: PN0021-2011

Drafting Date: 02/01/2011

Current Status: Clerk's Office for Bulletin

Version: 1

Matter Type: Public Notice

Title

Notice/Advertisement Title: Public Hearing - Columbus Art Commission

Contact Name: Lori Baudro, AICP

Contact Telephone Number: 645-6986

Contact Email Address: lsbaudro@columbus.gov

Body

Public Hearing -- Columbus Art Commission

The Columbus Art Commission has two meetings scheduled in February 2011:

- Ø Business Meeting
8:30 to 10:30 am on Wednesday, February 9, 2011
At the King Arts Complex, 867 Mt. Vernon Avenue, Columbus, Ohio
- Ø Regular Commission Meeting
6:00 to 8:00 pm on Thursday, February 24, 2011
At the Columbus Health Department, 240 Parsons Avenue, Columbus, Ohio

For more information contact: Lori Baudro, AICP at 645-6986 or lsbaudro@columbus.gov

A sign language interpreter will be made available provided the Planning Division has at least 48 hours notice before the meeting. Call 645-6986 to make arrangements.

Legislation Number: PN0026-2011

Drafting Date: 02/02/2011

Current Status: Clerk's Office for Bulletin

Version: 1

Matter Type: Public Notice

Title

Notice/Advertisement Title: Columbus City Council Community Meeting

Contact Name: John Ivanic

Contact Telephone Number: (614) 645-6798

Contact Email Address: JPivanic@columbus.gov

Body

Columbus City Councilmembers will hold an informal community meeting to get to know area residents and become aware of issues that are of concern to them. The meeting will feature one-on-one conversations while discussing opportunities to build strong, safe and healthy neighborhoods.

Date: Tuesday, February 22, 2011

Time: 5:30 - 7:30 PM

Location:

Fedderson Recreation Center
3911 Dresden Street
Columbus, OH 43224

Legislation Number: PN0029-2011

Drafting Date: 02/03/2011

Current Status: Clerk's Office for Bulletin

Version: 1

Matter Type: Public Notice

Title

Notice/Advertisement Title: 2011 Health, Housing & Human Services Committee Meeting Notice

Contact Name: Diamond Emory

Contact Telephone Number: (614) 645-7379

Contact Email Address: DCEmory@Columbus.gov

Body

Council Member Hearcel F. Craig will host a Health, Housing & Human Services Committee Meeting on the dates listed below. Unless otherwise noted, the meetings will begin at 5:00 P.M. in City Council Chambers, located on the second floor of City Hall, 90 West Broad Street, Columbus, Ohio.

A valid picture ID is needed to enter City Hall. Members of the general public wishing to address the meeting must fill out a speaker slip. These speaker forms will be made available in Council Chambers until 5:00 P.M. on the day of the meeting.

- Wednesday, February 16, 2011
- Wednesday, March 2, 2011
- Wednesday, March 16, 2011
- Wednesday, April 6, 2011
- Wednesday, April 20, 2011
- Wednesday, May 4, 2011
- Wednesday, May 18, 2011
- Wednesday, June 1, 2011
- Wednesday, June 15, 2011
- Wednesday, July 6, 2011
- Wednesday, July 20, 2011
- Wednesday, September 7, 2011
- Wednesday, September 21, 2011
- Wednesday, October 5, 2011
- Wednesday, October 19, 2011
- Wednesday, November 2, 2011
- Wednesday, November 16, 2011
- Wednesday, December 7, 2011

Meeting dates and times subject to change.

Legislation Number: PN0030-2011

Drafting Date: 02/08/2011

Current Status: Clerk's Office for Bulletin

Version: 1

Matter Type: Public Notice

Title

Notice/Advertisement Title: Italian Village Commission Special Meeting

Contact Name: Randy Black

Contact Telephone Number: 645-6821

Contact Email Address: rblack@columbus.gov

Body

Italian Village Commission Special Meeting

There will be an Italian Village Commission Special Meeting held on Tuesday, February 22, 2011, at 109 N. Front St., in the Training Center, ground floor starting at 6:00pm.

Legislation Number: PN0031-2011

Drafting Date: 02/08/2011

Current Status: Clerk's Office for Bulletin

Version: 1

Matter Type: Public Notice

Title

Notice/Advertisement Title: Columbus City Council Community Meeting

Contact Name: John Ivanic

Contact Telephone Number: (614) 645-6798

Contact Email Address: JPIvanic@columbus.gov

Body

Columbus City Councilmembers will hold an informal community meeting to get to know area residents and become aware of issues that are of concern to them. The meeting will feature one-on-one conversations while discussing opportunities to build strong, safe and healthy neighborhoods.

Date: Tuesday, April 5, 2011

Time: 5:30 - 7:30 PM

Location:

Martin Janis Senior Center
600 E. 11th Avenue
Columbus, OH 43211

Legislation Number: PN0032-2011

Drafting Date: 02/08/2011

Current Status: Clerk's Office for Bulletin

Version: 1

Matter Type: Public Notice

Title

Notice/Advertisement Title: Columbus City Council Community Meeting

Contact Name: John Ivanic

Contact Telephone Number: (614) 645-6798

Contact Email Address: JPIvanic@columbus.gov

Body

Columbus City Councilmembers will hold an informal community meeting to get to know area residents and become aware of issues that are of concern to them. The meeting will feature one-on-one conversations while discussing opportunities to build strong, safe and healthy neighborhoods.

Date: Wednesday, April 13, 2011

Time: 5:30 - 7:30 PM

Location:

Westgate Community Center
455 S. Westgate Avenue
Columbus, OH 43204

Legislation Number: PN0034-2011

Drafting Date: 02/08/2011

Current Status: Clerk's Office for Bulletin

Version: 1

Matter Type: Public Notice

Title

Notice/Advertisement Title: Columbus City Council Community Meeting

Contact Name: John Ivanic

Contact Telephone Number: (614) 645-6798

Contact Email Address: JPIvanic@columbus.gov

Body

Columbus City Councilmembers will hold an informal community meeting to get to know area residents and become aware of issues that are of concern to them. The meeting will feature one-on-one conversations while discussing opportunities to build strong, safe and healthy neighborhoods.

Date: Tuesday, April 19, 2011

Time: 5:30 - 7:30 PM

Location:

Columbus Health Department
240 Parsons Avenue
Columbus, OH 43215

Legislation Number: PN0035-2011

Drafting Date: 02/09/2011

Current Status: Clerk's Office for Bulletin

Version: 1

Matter Type: Public Notice

Title

Notice/Advertisement Title: Near East Area Commission Meetings

Contact Name: Bonita Lee

Contact Telephone Number: 645-7964

Contact Email Address: btleec@columbus.gov

Body

Near East Area Commission General Meeting, 2nd Thursday of the month
(with the exception that there is no meeting in August)

NEAC Planning meeting, 3rd Thursday of the month
NEAC Zoning meeting, 3rd Tuesday of the month.

Meeting place: 950 E. Main Street, Neighborhood Policing Center
Meeting time: all meetings begin at 6:30 p.m.

"The agenda for the General meeting can be found at www.neighborhoodlink.com <<http://www.neighborhoodlink.com>>"

Contact: Margaret Cooley 614-937-0192

Legislation Number: PN0036-2011

Drafting Date: 02/15/2011

Current Status: Clerk's Office for Bulletin

Version: 1

Matter Type: Public Notice

Title

Notice/Advertisement Title: Property For Sale, Approximately 3,854 square foot building on approximately 11,880 square feet of land, and an adjacent undeveloped parcel containing 11,880 square feet, situated at 1551 Cleveland Avenue, Columbus, Ohio 43211

Contact Name: Real Estate Management Office

Contact Telephone Number: 614-645-5189

Contact Email Address: ralabarre@columbus.gov <<mailto:ralabarre@columbus.gov>>, jmdominguez@columbus.gov

Body

**NOTICE - PROPERTY FOR SALE
APPROXIMATELY 3,854 square feet, ±.54 ACRES
1551 CLEVELAND AVENUE
COLUMBUS, OHIO 43211**

BUILDING DESCRIPTION

The City of Columbus is inviting purchase offers for a subject site consisting of a vacant building containing approximately 3,854 square feet, situated on a parcel of land containing approximately .27 acres, and an adjacent undeveloped .27 acre parcel (Franklin County Auditor's Parcels 010-048327 and 010-048325), identified as 1551 Cleveland Avenue, Columbus Ohio.

The building is the old City of Columbus Fire Station 18, which was constructed in 1934. The first floor consists of a large drive-in bay, a large drive-through bay, a kitchen area, and bathroom. The second floor contains several rooms and a bathroom.

SITE DESCRIPTION

The site is located just north of 13th Avenue, within one mile of access to Interstate 71 via 17th Avenue. This is a two story brick building with full basement. In addition to the lot upon which the building sits, there is an adjacent lot containing 11,880 square feet (.273 acres) that is currently undeveloped. Access to the rear of these parcels is by means of an alley running between 13th and 14th Avenues.

All utilities are present at the site.

Both parcels together have approximately 176 feet of frontage on Cleveland Avenue, with a depth of approximately 135 feet. Traffic counts from Mid-Ohio Regional Planning reflect that the average daily traffic count for this section of Cleveland Avenue is approximately 18,000 vehicles per day.

The property is offered for sale, as-is, where-is.

ASKING PRICE

The property consisting of two parcels of land and building are offered for sale at a price of **\$106,000.**

ZONING

The property is currently zoned C-3. This zoning is General Commercial, Limited, allowing a broad range of commercial uses.

REMARKS

This property would be attractive as an auto repair shop, construction or trades location, restaurant/bar/drive through, with possible living quarters on the second floor. It also has excellent redevelopment possibilities which could fully utilize the adjacent vacant lot.

CONTACT INFORMATION

Roger LaBarre, 614-645-5184
Jim Dominguez, 614-645-5188

Legislation Number: PN0037-2011

Drafting Date: 02/15/2011

Current Status: Clerk's Office for Bulletin

Version: 1

Matter Type: Public Notice

Title

Notice/Advertisement Title: Property For Sale, Approximately 6,963 square foot building on approximately 10,890 square feet of land, situated at 1716 Parsons Avenue, Columbus, Ohio

Contact Name: Real Estate Management Office

Contact Telephone Number: 614-645-5189

Contact Email Address: ralabarre@columbus.gov <<mailto:ralabarre@columbus.gov>>, jmdominguez@columbus.gov

Body

**NOTICE - PROPERTY FOR SALE
APPROXIMATELY 6,963 square feet, .25 ACRES
1716 PARSONS AVENUE
COLUMBUS, OHIO 43207**

BUILDING DESCRIPTION

The **City of Columbus** is inviting purchase offers for a subject site consisting of a vacant building containing approximately 6,963 square feet, situated on a parcel of land containing approximately .25 acres, Franklin County Auditor's Parcel #010-066800, identified as 1716 Parsons Avenue, Columbus Ohio 43207.

This building is the old Fire Station 14, a two story brick building built in 1906. The building also features a full basement. The interior first floor includes two large drive-in bays, a large drive-through bay and an area for a kitchen. The second floor includes several large rooms, a large bathroom, and a room with a private bathroom, and several other rooms.

SITE DESCRIPTION

The property is situated at the southeast corner of Parsons Avenue and Hinman Avenue.

The site has approximately 90 feet of frontage on Parsons Avenue, and approximately 125 feet on Hinman Avenue. The site includes paved parking in the front, rear and south side of the lot. The south parking is within a fenced area. Traffic counts from Mid-Ohio Regional Planning is based on dated information from 1998, but reflected at that time that the average daily traffic count for this section of Parsons Avenue was approximately 9,000 vehicles per day.

All utilities are present at the site.

The property is offered for sale, as-is, where-is.

ASKING PRICE

The property is offered for sale at an asking price of **\$195,000**.

ZONING

The property is currently zoned C-4. This zoning is General Commercial, allowing a broad range of commercial uses.

REMARKS

This property would be attractive as an auto repair shop, construction or trades location, restaurant/bar/drive through, with the potential for an apartment on the second floor.

CONTACT INFORMATION

Roger LaBarre, 614-645-5184

Jim Dominguez, 614-645-5188

Legislation Number: PN0038-2011

Drafting Date: 02/15/2011

Current Status: Clerk's Office for Bulletin

Version: 1

Matter Type: Public Notice

Title

Public Notice

Notice/Advertisement Title: Demand Response Aggregator Designation

Contact Name: Joe Lombardi

Contact Telephone Number: (614) 645-6623

Contact E-mail JALombardi@columbus.gov

Body

REGULATION NOTICE

BY ORDER OF THE DIRECTOR OF PUBLIC UTILITIES

Pursuant to Ordinance 0067-2009 and the Federal Regulatory Commission (FERC) Order No. 719 the Director of the Department of Public Utilities hereby adopts, establishes, and publishes these rules and regulations to be effective ten (10) days after second appearance in the City Bulletin. These rules and regulations are in addition to any requirements presently established or as may be established from time to time by Ordinance or Resolution of City Council or by rules and regulations that may be adopted by the Department of Public Utilities or other offices, boards, commissions, agencies, divisions, or departments of the City.

FERC Order No. 719 requires electric utilities to accept bids into their market for demand response of retail customers that are aggregated by Aggregators of Retail Customers unless the laws and regulation of the relevant electric regulatory authority prohibits a retail customer from participation except through their municipal utility.

Ordinance 0067-2009 authorized the City of Columbus or authorized designee as the sole entity permitted to aggregate retail customers' demand response and bid demand response on behalf of retail customers of the electric utility of the City of Columbus directly into any FERC approved independent system operator's or regional transmission organization's organized electric market. Furthermore Ordinance 0067-2009 authorized the Director of Public Utilities to adopt any regulations to implement ordinance.

DIRECTOR 'S REGULATIONS PURSUANT TO ORDINANCE 0067-2009 AND THE FEDERAL ENERGY REGULATORY COMMISSION (FERC) ORDER NO. 719 TO DESIGNATE A DEMAND RESPONSE AGGREGATOR

In accordance with Ordinance 0067-2009, Energy Connect Inc (ECI) is hereby designated as the authorized demand response aggregator for retail customers of the City's electric utility.

By Order Of:

Tatyana Arsh, P.E.

Director

Legislation Number: PN0039-2011

Drafting Date: 02/15/2011

Current Status: Clerk's Office for Bulletin

Version: 1

Matter Type: Public Notice

Title

Notice/Advertisement Title: Finance Committee Hearing: 2011 Capital Improvements Budget

Contact Name: Carl Williams, Legislative Aide, Councilmember Priscilla R. Tyson

Contact Telephone Number: 614-645-2932

Contact Email Address: cgwilliams@columbus.gov

Body

Columbus City Councilmember Priscilla R. Tyson, chair of the Finance Committee, will conduct a public hearing to discuss the 2011 Capital Improvements Budget. The Directors of Finance and Management, Public Utilities, Department of Public Safety, Department of Public Service, Department of Technology, Recreation and Parks Department, and Department of Development will also attend the meeting. Each Director will be asked to report on projects in their respective departments.

What: Finance Committee Briefing 2011 Capital Budget

Who: Councilmember Priscilla R. Tyson, chair of the Finance Committee

When: Tuesday March 1st 2011
4:30 pm

Where: City Hall
Columbus City Council Chambers
90 West Broad Street
Columbus, OH 43215

Some public testimony will also be accepted. Those wishing to testify should fill out a speaker slip on the day of the hearing between the hours of 8:00 am - 4:30 pm in the lobby entrance located on the Front Street side of City Hall. Free parking is available in the Gay Street parking lot on the north side of City Hall after 5:00 pm.

Written comments are also welcomed. If you'd like to share your thoughts please forward them to Columbus City Council 90 West Broad Street Columbus, Ohio 43215.

Legislation Number: PN0040-2011

Drafting Date: 02/15/2011

Current Status: Clerk's Office for Bulletin

Version: 1

Matter Type: Public Notice

Title

Notice/Advertisement Title: Finance Committee Hearing: 2011 Capital Improvements Budget

Contact Name: Carl Williams, Legislative Aide, Councilmember Priscilla R. Tyson
Contact Telephone Number: 614-645-2932
Contact Email Address: cgwilliams@columbus.gov

Body

Columbus City Councilmember Priscilla R. Tyson, chair of the Finance Committee, will conduct a public hearing to discuss the 2011 Capital Improvements Budget. This hearing will primarily allow residents a specific opportunity to address Council regarding the Capital Improvements Budget.

What: Finance Committee Hearing: 2011 Capital Budget: **Public Comment**

Who: Councilmember Priscilla R. Tyson, chair of the Finance Committee

When: Thursday March 3rd 2011
5:00 pm

Where: City Hall
Columbus City Council Chambers
90 West Broad Street
Columbus, OH 43215

Public testimony will also be accepted. Those wishing to testify should fill out a speaker slip on the day of the hearing between the hours of 8:00 am - 5:00 pm in the lobby entrance located on the Front Street side of City Hall. Free parking is available in the Gay Street parking lot on the north side of City Hall after 5:00 pm.

Legislation Number: PN0041-2011

Drafting Date: 02/16/2011

Current Status: Clerk's Office for Bulletin

Version: 1

Matter Type: Public Notice

Title

Notice/Advertisement Title: Wheelchair Ramp Requirements - Rules and Regulations

Contact Name: Randy Bowman, Administrator, Division of Mobility Options

Contact Telephone Number: 645-2464

Contact Email Address: rjbowman@columbus.gov

Body

Please see PN0041-2011 Wheelchair Ramps FINAL RULES AND REGULATIONS.pdf. Effective Date: March 5, 2011.

Mark Kelsey
Director
Department of Public Service

Legislation Number: PN0042-2011

Drafting Date: 02/16/2011

Current Status: Clerk's Office for Bulletin

Version: 1

Matter Type: Public Notice

Title

Notice/Advertisement Title: University Area Review Board Meeting

Contact Name: Daniel Ferdelman
Contact Telephone Number: 645-6096
Contact Email Address: dbferdelman@columbus.gov

Body

University Area Review Board Meeting Announcement
The UARB will be meeting February 24, 2011 beginning at 6:30pm at the Northside Library (1423 N. High St.).
For more information contact Daniel Ferdelman, AIA at (614) 645-6096 or dbferdelman@columbus.gov
[<mailto:dbferdelman@columbus.gov>](mailto:dbferdelman@columbus.gov)

Legislation Number: PN0043-2011

Drafting Date: 02/16/2011

Current Status: Clerk's Office for Bulletin

Version: 1

Matter Type: Public Notice

Title

Notice/Advertisement Title: Columbus Board of Zoning Adjustment February 22, 2011 Agenda

Contact Name: David Reiss

Contact Telephone Number: 645-7973

Contact Email Address: djreiss@columbus.gov

Body

AGENDA

BOARD OF ZONING ADJUSTMENT

CITY OF COLUMBUS, OHIO

FEBRUARY 22, 2011

The Columbus Board of Zoning Adjustment will hold a public hearing on the following applications on **TUESDAY, FEBRUARY 22, 2011** at **6:00 P.M.** in the First Floor Hearing Room of the Department of Building & Zoning Services, 757 Carolyn Avenue.

The Board of Zoning Adjustment hears requests for Special Permits, Appeals and Variances to the requirements of the Columbus Zoning Code, Title 33, of the Columbus City Codes. The Board does not hear applications to amend the Official Zoning Map. Specific case information may be obtained by contacting the Department of Building & Zoning Services, 757 Carolyn Avenue, 645-4522.

SPECIAL NOTE TO THE APPLICANT: It is important that you or your representative be present at the public hearing. It is the rule of the Board to dismiss an application when a representative is not present.

SIGN LANGUAGE INTERPRETER: An interpreter will be made available for anyone in need of this service. To request an interpreter, please contact the City of Columbus, Department of Building & Zoning Services at 645-4522 at least four (4) hours before the scheduled meeting time.

1. Application No.: 10310-00568

Location: 470 CANYON DRIVE NE (43214), located the northwest corner of North Canyon Drive and North East Canyon Drive.

Area Comm./Civic: Clintonville Area Commission

Existing Zoning: R-3, Residential District

Request: Variance(s) to Section(s):

3332.21, Building lines

To reduce the building line from 25' to 3'.

3342.18, Parking setback line

To reduce the parking setback from 25' to 12'.

3332.26, Minimum side yard permitted.

To reduce the minimum side yard from 5' to 4.68' on the western property line.

Proposal: A carport.

Applicant(s): Richard Buchsieb Jr.; 2445 Kensington Drive; Columbus, OH 43221

Property Owner(s): Kenneth F. Hewes; 470 Canyon Drive, NE; Columbus, OH 43214

Case Planner: Jamie Freise, 645-6350

E-mail: JFFreise@Columbus.gov

2. Application No.: 10310-00569

Location: 48 EAST 15TH AVENUE (43201), located on the north side of E. 15th Ave., 50 ft. east of Pearl Al.

Area Comm./Civic: University Area Commission

Existing Zoning: AR-4, Apartment Residential District

Request: Variances(s) to Section(s):

3333.23, Minimum side yard permitted.

To reduce the minimum side yard from 5 ft. to 4.8 ft.

3333.24, Rear yard.

To reduce the minimum rear yard from 25% of the total lot area to 16 +/-%.

3312.13, Driveway.

To reduce the minimum width of a driveway for 2-way travel from 20 ft. to 13+/- ft. along parking spaces #13 &

#16.

3312.21, Landscaping and screening.

To reduce the minimum area of a landscaping island from 145 sq. ft. to 112+/- sq. ft. between parking spaces #10

& #11.

3312.27, Parking setback line.

To reduce the minimum parking setback from 25 ft. to 10 ft.

3372.521, Supplemental parking requirements.

To allow the existing parking and maneuvering to continue to occur in the required side yard or required landscaped area and between the building and public street. To not separate the parking area from the required yard or landscaped area by an 8 in. high curb or other permanent barrier.

3372.562, Landscaped area and treatment.

To not plant live vegetation behind the most rear portion of the building or to plant a tree for each ten (10) parking spaces.

3372.564, Parking.

To increase the allowable area of the lot to be devoted to parking and maneuvering of vehicles from 35% of the lot area to 45+/-% of the lot area.

3372.567, Maximum floor area.

To increase the limit of the maximum floor area from 0.60 to be 0.82+/- for an existing building.

Proposal: To convert an existing building from a property management office and five (5) dwelling units to eight (8) dwelling units only.

Applicant(s): Garland Properties L.T.D.; c/o Donald Plank; Plank Law Firm; 145 E. Rich St., 3rd Floor; Columbus,

Ohio 43215

Property Owner(s): Same as applicant.

Case Planner: Dave Reiss, 645-7973

E-mail: DJReiss@Columbus.gov

3. Application No.: 10310-00571

Location: 5805 FRANTZ ROAD (43016), located on the west side of Frantz Rd., at the terminus of Ballymead Blvd.

Area Comm./Civic: Shannon Heights, Kilbannon, Kildaire Civic Association

Existing Zoning: CPD, Commercial Planned Development District

Request: Variance(s) to Section(s):

3312.49, Minimum number of parking spaces required.

To increase the allowable number of parking spaces from 15 to 25.

Proposal: To construct a bank.

Applicant(s): Brian Quackenbush, P.E.; c/o E.M.H.&T.; 5500 New Albany Rd.; Columbus, Ohio 43054

Property Owner(s): Ned Brickman; c/o Karric Square Outlot, L.L.C.; 11045 N. Towne Square Rd.; Mequon,
Wisconsin

53092

Case Planner: Dave Reiss, 645-7973

E-mail: DJReiss@Columbus.gov

4. Application No.: 10310-00572

Location: 5809 RIVERTON ROAD (43232), located on the south side of Riverton Road approximately 360 feet east of Yorkland Road.

Area Comm./Civic: None

Existing Zoning: SR, Suburban Residential District

Request: Variance(s) to Section(s):

3332.38, Private garage.

To increase the allowable portion of the lot area devoted to a private garage from 720 feet to 996 feet.

3312.13, Driveway. To decrease the minimum width of a driveway from 10 feet to 8.8 feet

Legislation Number: PN0044-2011

Drafting Date: 02/16/2011

Current Status: Clerk's Office for Bulletin

Version: 1

Matter Type: Public Notice

Title

Notice/Advertisement Title: Columbus Board of Zoning Adjustment February 22, 2011 Appeals Agenda

Contact Name: David Reiss

Contact Telephone Number: 645-7973

Contact Email Address: djreiss@columbus.gov

Body

APPEALS AGENDA

BOARD OF ZONING ADJUSTMENT

CITY OF COLUMBUS

FEBRUARY 22, 2011

The Columbus Board of Zoning Adjustment will hold a public hearing on the following applications on **TUESDAY, FEBRUARY 22, 2011** at **6:00 P.M.** in the First Floor Hearing Room of the Building Services Division Offices, 757 Carolyn Avenue.

The Board of Zoning Adjustment hears requests for Special Permits, Appeals and Variances to the requirements of the Columbus Zoning Code, Title 33, of the Columbus City Codes. The Board does not hear applications to amend the Official Zoning Map. Specific case information may be obtained by contacting the Building and Development Services Section, 757 Carolyn Avenue, 645-7314.

SPECIAL NOTE TO THE APPLICANT: It is important that you or your representative be present at the public hearing. It is the rule of the Board to dismiss an application when a representative is not present.

SIGN LANGUAGE INTERPRETER: An interpreter to "Sign" this meeting will be made available for anyone with a need for this service, provided the Building Services Division is made aware of this need and given a reasonable notice of at least four (4) hours prior to the scheduled meeting time. To schedule an interpreter, please contact the City of

Columbus, Human Resources Department at 645-6373 or TDD 645-3293.

THE FOLLOWING CASES WILL BE HEARD BEGINNING AT 6:00 P.M.:

1. 10312-00435
3600 JOHNNY APPLESEED COURT
Northland Community Council
L-M, Limited Manufacturing

To Appeal Zoning Code Violation Order No. 09470-03475 issued on 9/24/2010 for:

1. 3305.01, Certificate of zoning clearance.
2. 3389.02, Special permit required.

City Staff: Aubert Saunders

City Staff Phone: 645-7931

Appellant: Walter G. & Lois J. Reiner, 5030 Westerville Rd., Columbus, Ohio 43231

Owner: Not provided

Attorney/Agent: William J. Rees, 1332 Inglis Ave., Columbus, Ohio 43212

Legislation Number: PN0045-2011

Drafting Date: 02/16/2011

Current Status: Clerk's Office for Bulletin

Version: 1

Matter Type: Public Notice

Title

Notice/Advertisement Title: Communications 021911

Contact Name: Toya Johnson

Contact Telephone Number: 645-7293

Contact Email Address: tjjohnson@columbus.gov

Body

THE CITY CLERK'S OFFICE RECEIVED THE FOLLOWING COMMUNICATIONS AS OF WEDNESDAY FEBRUARY 16, 2011.

New Type: D3
To: Jing Da LLC
DBA Great China Bistro
3586 E Dublin Granville
Columbus OH 43235
Permit # 42906120005

Transfer Type: C2, C2X, D6
To: N & I LLC
DBA Quick Stop
2776 E 5th Av
Columbus OH 43219
From: Resham LLC
DBA Quick Stop
2776 5th Av
Columbus OH 43219
Permit # 6277256

New Type: D2
To: Quezadiaz Inc

2159 N High St & Patio
Columbus OH 43201
Permit # 7138021

Transfer Type: D1
To: Jing Da LLC
DBA Great China Bistro
3586 E Dublin Granville
Columbus OH 43235
From: Daniel L Pizzurro
DBA Hilltop Café
2142 Sullivant Av 1st Fl Bsmt & Patio
Columbus OH 43223
Permit # 42906120005

Transfer Type: D2
To: Jing Da LLC
DBA Great China Bistro
3586 E Dublin Granville
Columbus OH 43235
From: Daniel L Pizzurro
DBA Bottoms Café
1st Fl & Bsmt & Patio
177 S Cypress Av
Columbus OH 43223
Permit # 42906120005

Stock Type: D1, D2, D6
To: AED Enterprises LLC
DBA Deweys Pizza
1327 W Fifth Av
Columbus OH 43212
Permit # 00661240065

Transfer Type: D5, D6
To: Harvest Pizzeria LLC
& Patio
495 S Fourth St
Columbus OH 43215
From: Aramark Sports & Entertainment
Services LLC
DBA Cols Convention Ctr
500 N High St & Patio
Columbus OH 43215
Permit # 3648903

Transfer Type: D5A, D6
To: Ajeac Inc
DBA Hybrid Hospitality
Fort Rapids Indoor Waterpark Resort
4560 Hilton Corporate Dr
Columbus OH 43232
From: Platinum Lodging LLC
American Resort Mgmt Rcvr

DBA Holiday Inn
4560 Hilton Corporate Dr
Columbus OH 43232
Permit # 0084356

Transfer Type: C1, C2
To: Briggs Food LLC
DBA Briggs Stop Mart
3452 Briggs Rd
Columbus OH 43204
From: Koh Kong Ltd
DBA Koh Kong Market
3452 Briggs Rd
Columbus OH 43204
Permit # 0951958

Transfer Type: D1, D2, D3, D3A, D6
To: PNCJ Inc
104-106 Vine St & Patio
Columbus OH 43215
From: Tyfoon of Ohio LTD
104-106 Vine St & Patio
Columbus OH 43215
Permit # 6971474

Advertise: 02/19/2011
Return: 03/01/2011

Legislation Number: PN0046-2011

Drafting Date: 02/18/2011

Version: 1

Current Status: Clerk's Office for Bulletin

Matter Type: Public Notice

Title

Notice/Advertisement Title: West Broad Street Commercial Overlay Public Notice
Contact Name: Andrea Blevins, City Clerk
Contact Telephone Number: 614-645-7431
Contact Email Address: anblevins@columbus.gov

Body

NOTICE OF PUBLIC HEARING
OFFICE OF THE CITY CLERK
ROOM 231 - CITY HALL
COLUMBUS, OHIO

Dear Property Owner:

As the owner of record of property within the boundaries of the proposed Urban, Community and Regional Commercial Zoning Overlays on portions of West Broad Street, Georgesville Road, Grace Street, Alberta Street, Dwight Avenue, Phillipi Road and Wilson Road in the Greater Hilltop, you are hereby notified that a public meeting is scheduled as noted below:

PROPERTY OWNERS are not required by law to be present. However, this office is required by law to notify you of the proposed overlay so that you have the opportunity of expressing your approval or disapproval of said overlay. Speaker slips are available outside Council Chambers or in the Office of the City Clerk - Room 231 of City Hall. Speaker slips must be filed in Room 231 prior to 5:00 p.m. on the day of the hearing OR in the box located inside Council Chambers prior to 5:00 p.m. on the day of the hearing. Speaking before Council shall be limited to three (3) three-minute speakers by the proponents, and three (3) three-minute speakers for the opponents.

Date: **MONDAY, MARCH 7, 2011**
Time: **5:00 p.m.**
Location: **CITY HALL, 2ND FLOOR
COUNCIL CHAMBERS
90 WEST BROAD STREET
COLUMBUS, OHIO 43215**

These overlays only apply to commercially zoned or used parcels within the City of Columbus. Residentially zoned properties and properties that are used exclusively as residences are exempt from the standards and requirements of this overlay as are manufacturing uses. An overlay works in conjunction with the underlying zoning district to provide additional standards for such things as building setbacks, screening, and graphics. The overlay provisions impact new development and significant redevelopment. Overlay provisions are not applicable to routine property maintenance, such as restriping a parking lot or replacing windows.

For further information please contact Christine Palmer of the Planning Division, Development Department at 614.645.8791 or clpalmer@columbus.gov. Information is also available online at: www.tinyurl.com/HILLTOPoverlay

Legislation Number: PN0047-2011

Drafting Date: 02/18/2011

Version: 1

Current Status: Clerk's Office for Bulletin

Matter Type: Public Notice

Title

Notice/Advertisement Title: City Council Zoning Agenda for 02/28/2011

Contact Name: Shezronne Zaccardi

Contact Telephone Number: 614-645-1695

Contact Email Address: sezaccardi@columbus.gov

Body

REGULAR MEETING NO. 10

CITY COUNCIL (ZONING)

FEBRUARY 28, 2011

6:30 P.M.

COUNCIL CHAMBERS

ROLL CALL

READING AND DISPOSAL OF THE JOURNAL

EMERGENCY, TABLED AND 2ND READING OF 30 DAY LEGISLATION

ZONING: MILLER, CHR. CRAIG KLEIN MILLS PALEY TYSON GINTHER

0137-2011

To grant a Variance from the provisions of Sections 3333.02, AR-12, ARLD, and AR-1, apartment residential district use; 3333.23, Minimum side yard permitted; and 3333.24, Rear yard, of the Columbus City Codes; for the property located at 393 SOUTH OHIO AVENUE (43205), to permit a five-space parking lot with reduced development standards in the ARLD, Apartment Residential District (Council Variance # CV10-038).

0177-2011

To grant a Variance from the provisions of Sections 3332.039, R-4, Residential district; 3312.49, Minimum numbers of parking spaces required; and 3332.27, Rear yard, of the Columbus City Codes; for the property located at 1300 FORSYTHE AVENUE (43201), to allow a technical school with reduced development standards in the R-4, Residential District (Council Variance # CV10-040).

0224-2011

To grant a Variance from the provisions of Sections 3363.01, M-Manufacturing district; 3312.27, Parking setback lines; and 3312.49, Minimum number parking spaces required; of the Columbus City Codes for property located at 930 SOUTH FRONT STREET (43215), to allow two single-unit dwellings with reduced development standards in the M, Manufacturing District (Council Variance #CV10-042).

Legislation Number: PN0060-2005

Drafting Date: 02/23/2005

Current Status: Clerk's Office for Bulletin

Version: 1

Matter Type: Public Notice

Title

Notice/Advertisement Title: Published Columbus City Health Code

Contact Name: Roger Cloern

Contact Telephone Number: 654-6444

Contact Email Address: rogerc@columbus.gov

Body"The Columbus City Health Code is updated and maintained by the Columbus Health Department.

To view the most current City Health Code, please visit:

www.publichealth.columbus.gov

Legislation Number: PN0290-2010

Drafting Date: 11/03/2010

Current Status: Clerk's Office for Bulletin

Version: 1

Matter Type: Public Notice

Title

Notice/Advertisement Title: 2011 Meeting Schedule - City of Columbus Records Commission

Contact Name: Toya Johnson, Records Commission Coordinator

Contact Telephone Number: 645-7293

Contact Email Address: tjjohnson@columbus.gov

Body

**CITY BULLETIN NOTICE
MEETING SCHEDULE
CITY OF COLUMBUS RECORDS COMMISSION**

The regular meetings of the City of Columbus Records Commission for the calendar year 2011 are scheduled as follows:

Monday, February 14, 2011

Monday, May 9, 2011

Monday, September 19, 2011

These meetings will take place at: City Hall, 90 West Broad Street, 2nd Floor, in the City Council Conference Room (226). They will begin promptly at 10:00 am.

Every effort will be made to adhere to the above schedule, but the City of Columbus Records Commission reserves the right to change the date, time, or location of any meeting; or to hold additional meetings. To confirm the meeting date, time, and locations or to obtain agenda information, contact the Office of the City of Columbus Records Commission Coordinator - (614) 645-7293.

Advertise: 01/01/2011 to 9/17/2011

Legislation Number: PN0315-2010

Drafting Date: 12/08/2010

Version: 1

Current Status: Clerk's Office for Bulletin

Matter Type: Public Notice

Title

**OFFICIAL NOTICE
CIVIL SERVICE COMMISSION
COMPETITIVE EXAMINATION ANNOUNCEMENTS**

Notice/Advertisement Title: Civil Service Commission Notice

Contact Name: Annette Bigham

Contact Telephone Number: 614.645.7531

Contact Email Address: eabigham@columbus.gov

Body

OFFICIAL NOTICE
CIVIL SERVICE COMMISSION
COMPETITIVE EXAMINATION ANNOUNCEMENTS

APPLY ONLINE 24 HOURS A DAY, 7 DAYS A WEEK OR APPLY IN PERSON 9:00 A.M. TO 4:00 P.M. MONDAY, WEDNESDAY, or THURSDAY.

The Civil Service Commission continuously administers competitive examinations. Information regarding examinations, for which the Civil Service Commission is currently accepting applications, is located on our website at www.csc.columbus.gov and is also posted at the Commission offices located at 50 West Gay Street, 6th Floor, Columbus, Ohio. Please note that all visitors to the Beacon Building are required to produce a picture ID, authenticating their identity, in order to visit the applications area. Applicants interested in City jobs should check our website or visit the Commission offices.

Legislation Number: PN0321-2010

Drafting Date: 12/14/2010

Current Status: Clerk's Office for Bulletin

Version: 1

Matter Type: Public Notice

Title

Notice/Advertisement Title: Recreation & Parks Commission Meetings

Contact Name: Eric L. Brandon

Contact Telephone Number: 614-645-5253

Contact Email Address: ebrandon@columbus.gov

Body

NOTICE OF REGULAR MEETINGS COLUMBUS RECREATION AND PARKS COMMISSION

The Recreation and Parks Commission, appointed and organized under the Charter of the City of Columbus, Section 112-1 is empowered to equip, operate, direct and maintain all the existing recreational and park facilities. In addition, said Commission exercises certain powers and duties as specified in Sections 112-1 and 112-2 of the Columbus City Charter.

Please take notice that meetings of the Recreation and Parks Commission will be held at 8:30 a.m. on the following dates and locations (unless otherwise posted):

- o Wednesday, January 12, 2011 - 1111 East Broad St, 43205
- o Wednesday, February 9, 2011 - 1111 East Broad St, 43205
- o Wednesday, March 9, 2011 - 1111 East Broad St, 43205
- o Wednesday, April 13, 2011 - 1111 East Broad St, 43205
- o Wednesday, May 11, 2011 - 1111 East Broad St, 43205
- o Wednesday, June 8, 2011 - 1111 East Broad St, 43205
- o Wednesday, July 13, 2011 - 1111 East Broad St, 43205
- o August Recess - No meeting
- o Wednesday, September 14, 2011 - 1111 East Broad St, 43205
- o Wednesday, October 12, 2011 - 1111 East Broad St, 43205
- o Wednesday, November 9, 2011 - 1111 East Broad St, 43205
- o Wednesday, December 14, 2011 - 1111 East Broad St, 43205

In the event no proper business exists the meeting may be cancelled without further notice. For further information you may contact the Recreation and Parks Department, 1111 E. Broad St., Columbus, Ohio 43205 (Telephone: [614] 645-5253).

Legislation Number: PN0322-2010

Drafting Date: 12/14/2010

Version: 1

Current Status: Clerk's Office for Bulletin

Matter Type: Public Notice

Title

Notice/Advertisement Title: Downtown Commission 2011 Meetings

Contact Name: Daniel Thomas

Contact Telephone Number: 645-8404

Contact Email Address: djthomas@columbus.gov

Body

Downtown Commission 2011 Meetings

Business Meeting
 109 N. Front St.
 1st Fl. Conf. Rm
 8:30am - 10:00am

Regular Meeting
 109 N. Front St.
 Training Center
 8:30am - 11:00am

February 10, 2011
April 14, 2011
June 9, 2011
August 11, 2011
October 13, 2011
December 8, 2011

January 25, 2011
February 22, 2011
March 22, 2011
April 26, 2011
May 24, 2011
June 28, 2011
July 26, 2011
August 23, 2011
September 27, 2011
October 25, 2011
November 22, 2011
December 20, 2011

A Sign Language Interpreter will be made available for anyone with a need for this service, provided the Planning Division is made aware of this need and given a reasonable notice of at least forty-eight (48) hours prior to the scheduled meeting time. To schedule, please call 645-8036.

Legislation Number: PN0323-2010

Drafting Date: 12/14/2010

Version: 1

Current Status: Clerk's Office for Bulletin

Matter Type: Public Notice

Title

Notice/Advertisement Title: German Village Commission 2011 Meetings

Contact Name: Randy Black

Contact Telephone Number: 645-6821

Contact Email Address: rblack@columbus.gov

Body

German Village Commission 2011 Meeting Schedule

The German Village Commission has its Regular Meeting the 1st Tuesday of every month (barring Holiday exceptions). Copies of the Agenda may be obtained by calling 645-8620 or by e-mail to ljpoulton@columbus.gov. A Sign Language Interpreter will be made available provided the Historic Preservation Office is given a reasonable notice of at least forty-eight (48) hours prior to the scheduled Regular meeting time. To schedule, please call 645-8036.

Application Deadline:

December 21, 2010
January 18, 2011
February 15, 2011
March 22, 2011
April 19, 2011
May 24, 2011
June 21, 2011
July 19, 2011
August 23, 2011
September 20, 2011
October 18, 2011
November 22, 2011
December 20, 2011

Business Meeting Dates

(1st fl. Conf. Rm, 109 N. Front St.)

12:00pm :

December 28, 2010
January 25, 2011
February 22, 2011
March 29, 2011
April 26, 2011
May 31, 2011
June 28, 2011
July 26, 2011
August 30, 2011
September 27, 2011
October 25, 2011
November 29, 2011
December 27, 2011

Regular Meeting Dates

(German Village Meeting Haus

588 S Third St.) 4:00 pm :

January 4, 2011
February 1, 2011
March 1, 2011
April 5, 2011
May 3, 2011
June 7, 2011
July 12, 2011
August 2, 2011
September 13, 2011
October 4, 2011
November 1, 2011
December 6, 2011

Mail or deliver completed Certificate of Appropriateness applications to:

City of Columbus
Historic Preservation Office
109 N. Front St. - Ground Floor
Columbus OH 43215-9031

Legislation Number: PN0324-2010

Drafting Date: 12/14/2010

Version: 1

Current Status: Clerk's Office for Bulletin

Matter Type: Public Notice

Title

Notice/Advertisement Title: Brewery District Commission 2011 Meetings

Contact Name: Randy Black

Contact Telephone Number: 645-6821

Contact Email Address: rblack@columbus.gov

Body

Brewery District Commission 2011 Meeting Schedule

The Brewery District Commission has its Regular Meeting the 1st Thursday of every month (barring Holiday exceptions). Copies of the Agenda may be obtained by calling 645-8620 or by e-mail to ljoulton@columbus.gov. A Sign Language Interpreter will be made available provided the Historic Preservation Office is made aware of this need and given a reasonable notice of at least forty-eight (48) hours prior to the scheduled meeting time. To schedule, please call 645-8036.

Application Deadline:

December 23, 2010
January 20, 2011
February 17, 2011
March 24, 2011
April 21, 2011
May 19, 2011
June 23, 2011

July 21, 2011
August 18, 2011
September 22, 2011
October 20, 2011
November 17, 2011
December 22, 2011

Business Meeting Dates (1st fl. Conf. Rm, 109 N. Front St.) 12:00pm	Regular Meeting Date (Training Center, 109 N. Front St.) 6:15pm
---	---

December 30, 2010	January 6, 2011
January 27, 2011	February 3, 2011
February 24, 2011	March 3, 2011
March 31, 2011	April 7, 2011
April 28, 2011	May 5, 2011
May 26, 2011	June 2, 2011
June 30, 2011	July 7, 2011
July 28, 2011	August 4, 2011
August 25, 2011	September 1, 2011
September 29, 2011	October 6, 2011
October 27, 2011	November 3, 2011
November 24, 2011	December 1, 2011
December 29, 2011	

Mail or deliver completed Certificate of Appropriateness applications to:

City of Columbus
Historic Preservation Office
109 N. Front St. - Ground Floor
Columbus OH 43215-9031

Legislation Number: PN0325-2010

Drafting Date: 12/14/2010

Version: 1

Current Status: Clerk's Office for Bulletin

Matter Type: Public Notice

Title

Notice/Advertisement Title: Victorian Village Commission 2011 Meetings

Contact Name: Randy Black

Contact Telephone Number: 645-6821

Contact Email Address: rblack@columbus.gov

Body

Victorian Village Commission 2011 Meeting Schedule

The Victorian Village Commission has its Regular Meeting the 2nd Thursday of every month (barring Holiday exceptions). Copies of the Agenda may be obtained by calling 645-8620 or by e-mail to ljpoulton@columbus.gov. A Sign Language Interpreter will be made available provided the Historic Preservation Office is given a reasonable notice of at least forty-eight (48) hours prior to the scheduled Regular meeting time. To schedule, please call 645-8036.

Application Deadline:

January 27, 2011
February 24, 2011
March 31, 2011
April 28, 2011
May 26, 2011
June 30, 2011
July 28, 2011
August 25, 2011
September 29, 2011
October 27, 2011
November 24, 2011
December 29, 2011

Business Meeting Dates (1st fl. Conf. Rm, 109 N. Front St.) 12:00pm	Regular Meeting Date (Training Center, 109 N. Front St.) 6:15pm
---	---

January 6, 2011	January 13, 2011
February 3, 2011	February 10, 2011
March 3, 2011	March 10, 2011
April 7, 2011	April 14, 2011
May 5, 2011	May 12, 2011
June 2, 2011	June 9, 2011
July 7, 2011	July 14, 2011
August 4, 2011	August 11, 2011
September 1, 2011	September 8, 2011
October 6, 2011	October 13, 2011
November 3, 2011	November 10, 2011
December 1, 2011	December 8, 2011

Mail or deliver completed Certificate of Appropriateness applications to:

City of Columbus
Historic Preservation Office
109 N. Front St. - Ground Floor
Columbus OH 43215-9031

Legislation Number: PN0326-2010

Drafting Date: 12/14/2010

Version: 1

Current Status: Clerk's Office for Bulletin

Matter Type: Public Notice

Title

Notice/Advertisement Title: Italian Village Commission 2011 Meetings

Contact Name: Randy Black

Contact Telephone Number: 645-6821

Contact Email Address: rblack@columbus.gov

Body

Italian Village Commission 2011 Meeting Schedule

The Italian Village Commission has its Regular Meeting the 3rd Tuesday of every month (barring Holiday exceptions). Copies of the Agenda may be obtained by calling 645-8620 or by e-mail to ljpoulton@columbus.gov. A Sign Language Interpreter will be made available provided the Historic Preservation Office is given a reasonable notice of at least forty-eight (48) hours prior to the scheduled Regular meeting time. To schedule, please call 645-8036.

Application Deadline:

- January 4, 2011
- February 1, 2011
- March 1, 2011
- April 5, 2011
- May 3, 2011
- June 7, 2011
- July 5, 2011
- August 2, 2011
- September 6, 2011
- October 4, 2011
- November 1, 2011
- December 6, 2011

Business Meeting Dates	Regular Meeting Date
(1st fl. Conf. Rm, 109 N. Front St.)	(Training Center, 109 N. Front St.)
12:00pm	6:15pm

January 11, 2011	January 18, 2011
February 8, 2011	February 15, 2011
March 8, 2011	March 15, 2011
April 12, 2011	April 19, 2011
May 10, 2011	May 17, 2011
June 14, 2011	June 21, 2011
July 12, 2011	July 19, 2011
August 9, 2011	August 16, 2011
September 13, 2011	September 20, 2011
October 11, 2011	October 18, 2011
November 8, 2011	November 15, 2011
December 13, 2011	December 20, 2011

Mail or deliver completed Certificate of Appropriateness applications to:

City of Columbus
Historic Preservation Office
109 N. Front St. - Ground Floor
Columbus OH 43215-9031

Legislation Number: PN0327-2010

Drafting Date: 12/14/2010

Version: 1

Current Status: Clerk's Office for Bulletin

Matter Type: Public Notice

Title

Notice/Advertisement Title: Historic Resource Commission 2011 Meetings

Contact Name: Randy Black

Contact Telephone Number: 645-6821

Contact Email Address: rblack@columbus.gov

Body

Historic Resource Commission 2011 Meeting Schedule

The Historic Resource Commission has its Regular Meeting the 3rd Thursday of every month (barring Holiday exceptions). Copies of the Agenda may be obtained by calling 645-8620 or by e-mail to ljpoulton@columbus.gov. A Sign Language Interpreter will be made available provided the Historic Preservation Office is given a reasonable notice of at least forty-eight (48) hours prior to the scheduled Regular meeting time. To schedule, please call 645-8036.

Application Deadline:

- January 6, 2011
- February 3, 2011
- March 3, 2011
- April 7, 2011
- May 5, 2011
- June 2, 2011
- July 7, 2011
- August 4, 2011
- September 1, 2011
- October 6, 2011
- November 3, 2011
- December 1, 2011

Business Meeting Dates (1st fl. Conf. Rm, 109 N. Front St.) 12:00pm	Regular Meeting Date (Training Center, 109 N. Front St.) 6:15pm
---	---

January 13, 2011	January 20, 2011
February 10, 2011	February 17, 2011
March 10, 2011	March 17, 2011
April 14, 2011	April 21, 2011
May 12, 2011	May 19, 2011
June 9, 2011	June 16, 2011
July 14, 2011	July 21, 2011
August 11, 2011	August 18, 2011
September 8, 2011	September 15, 2011
October 13, 2011	October 20, 2011
November 10, 2011	November 17, 2011
December 8, 2011	December 15, 2011

Mail or deliver completed Certificate of Appropriateness applications to:

City of Columbus
Historic Preservation Office
109 N. Front St. - Ground Floor
Columbus OH 43215-9031

Legislation Number: PN0328-2010

Drafting Date: 12/14/2010

Current Status: Clerk's Office for Bulletin

Version: 1

Matter Type: Public Notice

Title

Notice/Advertisement Title: Board of Commission Appeals 2011 Meetings

Contact Name: Randy Black

Contact Telephone Number: 645-6821

Contact Email Address: rblack@columbus.gov

Body

Board of Commission Appeals 2011 Meeting Schedule

The Board of Commission Appeals has its Business Meeting the last Wednesday of every other month (as necessary and barring Holiday exceptions). Copies of the Agenda may be obtained by calling 645-8620 or by e-mail to ljpoulton@columbus.gov. A Sign Language Interpreter will be made available provided the Historic Preservation Office is given a reasonable notice of at least forty-eight (48) hours prior to the scheduled Regular meeting time. To schedule, please call 645-8036.

Business Meeting Dates

(1st fl. Conf. Rm, 109 N. Front St.)

12:00pm

January 26, 2011

March 30, 2011

May 25, 2011

July 27, 2011

September 28, 2011

November 30, 2011

RULES AND REGULATIONS

**DEPARTMENT OF PUBLIC SERVICE
CITY OF COLUMBUS, OHIO**

SUBJECT: Wheelchair Ramp Requirements **EFFECTIVE DATE:** March 5, 2011
PAGES: 36 **By:** Division of Mobility Options

TABLE OF CONTENTS

I	Authority	1
II	Application	1
III	Effective Date.....	1
IV	Background	2
V	Definitions.....	2
VI	Standards and References: Descriptions and Hierarchy	4
VII	Curb Ramp Construction: Conditions and Scoping	6
VIII	Curb Ramp Construction Scenarios.....	8
IX	Ramp Request Documentation and Rating System.....	16
X	Types of Curb Ramps	19
XI	General Ramp Requirements	23
XII	Design and Construction Procedures	26
XIII	Other Elements.....	28

I. AUTHORITY

Pursuant to the authority granted under Ordinance 1987-2008 passed December 15, 2008 (Section 2105.125 of the Columbus City Codes, 1959, as amended), the Director of Public Service hereby adopts, establishes, and publishes these rules and regulations to be effective at the earliest time allowed by law. These rules supersede rules previously promulgated in 1999.

II. APPLICATION

This policy shall be applicable to all wheelchair ramps installed within right-of-way controlled by the City of Columbus. This policy shall also replace and supersede the following General Policies and Procedure:

- “Location of Pedestrian Pushbuttons” – Effective Date October 1, 2005
- “Wheelchair Ramps – Detectable Warnings” – Effective March 1, 2004
- “Non-Paired Wheelchair Ramps and At-Grade Sidewalk Transitions - Effective November 15, 2006

III. EFFECTIVE DATE

This policy shall be effective March 5, 2011 and shall supersede all previous applicable policies and standards. All site plans, permits and capital improvement plans submitted for review following the effective date shall comply with these rules and regulations.

IV. BACKGROUND

The Americans with Disabilities Act (ADA) of 1990 established that it is discriminatory and a violation of a disabled person's civil rights to deny access to various public and privately owned facilities and resources that are accessible to able-bodied persons. Title II of ADA applies to state and local governments. Among the items listed in Title II that shall be made accessible are pedestrian facilities and routes along public rights-of-way. Responsibility for making these facilities compliant is the responsibility of the Department of Public Services, Division of Mobility Options (DOMO).

In order to provide a practical framework for determination of accessibility, the Access Board, an agency established by the Federal Government to create guidelines, developed the concept of the **Pedestrian Accessible Route**, or **PAR**. This is in essence a path through and contained within a pedestrian facility that has slope, grade, surface characteristic, and other features that make it usable by persons having certain mobility and sensory impairment conditions. The PAR must be an unbroken route that will provide access to any destination along a given right-of-way that can otherwise be reached by an able-bodied pedestrian. It may extend the entire width of a sidewalk or walkway, or it may consist of only a specified width of the overall walkway or path.

Wheelchair ramps, also known as curb ramps, are essential elements of a PAR and they are required when the route requires a change in elevation. This usually occurs at curbs at intersections, where an individual must travel from a sidewalk, down onto street level in order to negotiate a crosswalk, and then return to the sidewalk on the opposite side. However, curb ramps may be constructed any time a change in elevation is necessary.

Wheelchair ramps are constructed at curbed intersections, if a sidewalk is present. A variation of a curb ramp, blended transitions, may be constructed where sidewalk is present, but no curbs. Curb ramps may also be required when no sidewalk is present, but access is needed to pedestrian call buttons located off the roadway. In most cases, however, curb ramps do not need to be built where there is no sidewalk, since, by definition, the pedestrian route will be along the roadway pavement.

V. DEFINITIONS

The following words, terms and phrases, when used in these rules and regulations, shall have the meanings ascribed to them, except when the context clearly indicates a different meaning:

- A. **ADA** means Americans with Disabilities Act of 1990, and all subsequent amendments.
- B. **ADAAG** means ADA Accessibility Guidelines for Buildings and Facilities.
- C. **Alley** means a thoroughfare typically located in the middle of a block that allows access to the rear of buildings. ORC The legal definition of an alley used by the City of Columbus can be found in ORC 4511.01(XX).
- D. **Alteration** means a change to a facility that affects or could affect the usability of the facility or part thereof. Alterations include, but are not limited to, remodeling, renovation, rehabilitation, reconstruction, historic restoration, resurfacing of circulation paths or vehicular ways, or changes or rearrangement of the structural parts or elements. Normal maintenance is not considered an alteration unless it affects the usability of the facility.
- E. **Addition** means an expansion, extension or increase in the area of a facility. Additions are treated as new construction as defined in ADA.

- F. **Blended Transition** means a section of sidewalk constructed, within standards, to allow passage from one section of a PAR to another. These are not to be confused with curb ramps, and are not reimbursable as a separate unit item. Blended transitions are typically used in areas where no curb is in place.
- G. **“Columbus Pedestrian Thoroughfare Plan Handbook”** means a document prepared by the Division of Mobility Options that establishes standards for pedestrian walkways located throughout the City. It is referenced in order to establish pedestrian traffic and needs.
- H. **Consent Decree** means the First Amended Settlement Agreement between the Ohio Statewide Independent Living Council (OSILC) and the City of Columbus, dated December 20, 2000. Among other things, this document establishes that the City of Columbus must construct curb ramps where needed when road resurfacing is conducted.
- I. **Crosswalk** means (1) That part of a roadway at intersections ordinarily included within the real or projected promulgation of property lines and curb lines or, in the absence of curbs, the edges of the traversable roadway. (2) Any portion of a roadway at an intersection or elsewhere distinctly indicated for pedestrian crossing by lines or other markings on the surface. (COC Code 900.04). All crosswalks are required to be compliant. (ADAAG)
- J. **Curb Ramp** means a short ramp cutting through a curb or running up to it. (ADAAG F106.5). This is the primary means of providing an accessible route from sidewalks to crosswalks. The accessible portion of the curb ramp typically includes an upper landing, a lower landing, and a sloped ramp. Flares placed on either side of the sloped ramp are considered to be a part of the inaccessible portion of the ramp. The term “Wheelchair Ramp” has identical meaning.
- K. **Detectable Warning Unit** means a standardized surface feature built on or applied to walking surfaces or other elements to warn visually impaired people of hazards on a circulation path. These units are typically used in instances where pedestrians are passing from dedicated walking areas onto areas having vehicular traffic.
- L. **Developer** means, for the purposes of this document, the party initiating a project or process that will involve changes in the City right-of-way.
- M. **Intersection** means the area embraced within the prolongation or connection of the lateral curb lines, or, if none, then the lateral boundary lines of the roadways of two highways which join one another at, or approximately at, right angles, or the area within which vehicles traveling upon different highways joining at any other angle may come in conflict. (ORC 4511.01 KK)
- N. **Landing** means a relatively flat area (slope less than 1:48 or 2.08% in any direction) used by disabled individuals to move from one sloped area to another.
- O. **Long Flare** means the area adjacent to sloped portion of ramp that provides a transition from the sloped portion of the ramp to the existing surface. It is not designed to be part of an accessible route; however it is designed to be walked upon by able-bodied pedestrians.
- P. **New Build Projects** means a type of project that provides facilities in an area that had previously been unused and undeveloped. New build projects are subject to a higher level of compliance than the levels for additions or alterations.
- Q. **Orphan Ramp** - Also known as unmatched ramp. This means a ramp which provides access to a legal crosswalk for which there is no corresponding ramp on the opposite end that allows a disabled pedestrian to exit the crosswalk and access an existing sidewalk.

- R. **PROWAG** means the Proposed Right of Way Access Guidelines (Latest version: 2005)
- S. **PAR** means Pedestrian Accessible Route (For definition and explanation, see Section IV of this document.)
- T. **Resurfacing** means removal and replacement of a roadway surface curb-to-curb. This process is considered to be an alteration, therefore triggering ADA compliance.
- U. **Short Flare** means the area adjacent to sloped portion of ramp that provides a transition from the sloped portion of the ramp to the existing surface. It is not designed to be part of an accessible route. Unlike a long flare, it is not designed to be traversed by able-bodied individuals. This flare is only to be used when a ramp is adjacent to a non-walkable surface.

VI. STANDARDS AND REFERENCES: DESCRIPTIONS AND HIERARCHY

- A. **Enforceable Standards:** The Access Board initially issued the Americans with Disabilities Act Accessibility Guidelines (ADAAG) in 1991 (*36 CFR 1191, Appendix A*). ADAAG consists of general sections (ADAAG 1 to 4) that apply to all types of buildings and facilities, and special sections (ADAAG 5 to 12, and 15) that contain additional requirements for certain types of buildings and facilities. This document has been amended a number of times. The most recent version was released in July of 2004, and is the current standard. Whatever is the most recent version of “*ADA Accessibility Guidelines for Buildings and Facilities*” is commonly referred to as the ADAAG. It contains scoping and technical requirements for accessibility to buildings and facilities by individuals with disabilities under the Americans with Disabilities Act (ADA) of 1990. **These scoping and technical requirements are to be applied during the design, construction, and alteration of buildings and facilities covered by titles II and III of the ADA to the extent required by regulations issued by Federal agencies, including the Department of Justice and the Department of Transportation, under the ADA.** Until such time when more detailed Right-of-Way standards are approved, these are the legal, enforceable standards that constitute the ultimate authority regarding ADA issues until Title II and Title III.
- B. **Rights-of-Way:** The publication, “*Accessible Rights-of-Way: A Design Guide*,” was released in November, 1999 by the U.S. Access Board in cooperation with the Federal Highway Administration in order to provide advisory information until guidelines for public rights-of-way are developed. The document was created by the Public Rights of Way Access Advisory Committee (PROWAAC). This group of transportation professionals wrote the design guide in an effort to address specific challenges involved in construction work in rights-of-way, built on ADAAG standards. The 148-page guide shows how existing ADA standards for pedestrian routes on sites can be adapted for application to sidewalks and street crossings. It provides best practices recommendations, along with the rationale behind them, for the design, construction, alteration, and retrofit of public pedestrian facilities. Although final standards for the design and construction of accessible pedestrian facilities in the public right-of-way have not yet been published, existing ADA standards developed for pedestrian routes on sites can be adapted for application to sidewalks and street crossings.

Draft Right-Of-Way Guidelines Published. On June 17, 2002, the Board released another document, “Draft Guidelines for Accessible Public Rights-of-Way,” that was available for public comment until October 28, 2002. Another revision was made in 2005. In 2008, after the expiration of a 60 day comment period, the board announced its intention of implementing approval of this document in 2010. These guidelines focus more on specific issues related to pedestrian access to sidewalks and streets, including crosswalks, curb ramps, street furnishings, parking, and other components of public rights-of-way. The new provisions will supplement the Board’s ADA and ABA accessibility guidelines by adding a new chapter specific to public rights-of-ways. Until the final approval of these guidelines, the ADAAG will be the ultimate authority in ADA issues.

- C. City of Columbus Standards:** Communities are required to develop local standards that meet the standards and guidelines issued under the ADA. Columbus has developed standards to conform to federal regulations and guidelines, to adapt these guidelines to local conditions, and to supplement and clarify items that may not be addressed at the federal level. Columbus has adopted a position of following “best practice” wherever possible, rather than meeting only minimum enforceable standards.
- D. Hierarchy of Reference Documents:** Standards for the design and construction of items affecting the Pedestrian Access Route (PAR) within public right-of-way shall follow the order of precedence listed below (1-6). When standards are not addressed at one level, then the applicable standard from the next lower level shall govern.
1. “*General Policy and Procedure - Wheelchair Ramp Requirements*”, City of Columbus, Ohio, Department of Public Service.
 2. City of Columbus, Ohio standard drawings (notably #2319).
 3. City of Columbus, Ohio construction and materials specifications.
 4. City of Columbus Supplemental Specifications “1550 – Curb Ramps” and “1551 – Detectable Warnings.”
 5. “*ADA and ABA Accessibility Guidelines for Buildings and Facilities*”, U.S. Access Board, July 23, 2004. (ADAAG)
 6. First Amended Settlement Agreement, Ohio Statewide Independent Living Council, et al vs. City of Columbus, December 21, 2000.
 7. “*Draft Guidelines for Accessible Public Rights-of-Way*” U.S. Access Board, 2005.
 8. “*Accessible Rights-of-Way: A Design Guide*”, U.S. Access Board and Federal Highway Administration, 2005

Note: Item # 7 “Draft Guidelines for Accessible Public Rights-of-Way” will supersede item #5 “ADAAG” at such time that the ROW guidelines complete the final approval process by the Federal government, which is expected to occur in July, 2010.

Example: Current and proposed ADAAG standards generally specify a 36-inch minimum width for accessible routes, including curb ramps, on sites. The proposed guidelines for public rights-of-way recommend a 48-inch minimum pedestrian pathway. Columbus requires a 48-inch pedestrian access route.

Example: Current and proposed ADAAG standards generally allow single, diagonal, dual-direction ramps at the apex of a corner. Although the Access Board Advisory Committee recognized that providing two separate compliant curb ramps might not always be practicable, particularly in alterations, the “Draft Guidelines” strongly discourage the use of such ramps for reasons of pedestrian safety. Accordingly, Columbus does not permit construction of these diagonal or “shared” ramps in new construction, and only under very rare circumstances for retrofit of existing construction. When used in alterations, they shall receive prior written approval.

VII. CURB RAMP CONSTRUCTION: CONDITIONS AND SCOPING

A. General Scoping Requirements:

1. **New Construction and Additions:** All new construction having no pre-existing outside constraints located outside the scope of the project is subject to the full extent of PROWAG requirements. Examples of these types of projects include roadway extensions, construction of new sidewalks in undeveloped areas, new subdivisions, and other new developments.
2. **Alterations:** This work consists of making changes to existing facilities or by constructing new facilities or structures within existing rights-of-way. Compliance requirements are less strict than for new construction in that it is limited to work that is “technically feasible”; that is, work that is possible given the constraints imposed by the existing conditions. Compliance is required to be made to the maximum extent possible, given these constraints.

B. Specific Conditions:

1. **Roadways - New Construction or Addition.** New construction is subject to full compliance with PROWAG. Curb ramp styles designed to be used in alterations may not be used on these projects.
2. **Roadways – Alteration.** Curb ramps shall be constructed any time a curbed roadway undergoes an alternation and sidewalk is present. Roadway improvements that trigger installation of curb ramps include, but are not limited to, the following:
 - a. Improvements to the geometry of the intersection, such as installation of new turn lanes, or widening of existing lanes.
 - b. Signal Improvements
 - c. Grade elevation changes
 - d. Crosswalk striping improvements
 - e. Resurfacing
 - f. Streetscape improvements
3. **Corners.** In addition, all corners of all intersections affected by a given project, contained within the scope of said project, shall be made compliant. Even if road improvements were made that include only one part of an intersection, Title II requires that all PARs passing through that intersection shall be made compliant. Responsibility for this varies depending on the type of project. See following sections for more information.

Maintenance and repair work that does not “alter” existing elements of the pedestrian pathway triggers no obligation to provide accessible features. Examples of this work include but are not limited to the following:

- a. Spot patching and pothole repair
- b. Reseating of disturbed curbing
- c. Restriping of existing markings in place
- d. Thincoat sealing
- e. Microsurfacing
- f. Crack sealing
- g. Trenching for underground utility construction

4. Sidewalks – New Build or Addition. Full compliance is required for projects involving construction of new sidewalks in areas previously having no sidewalk facilities.

5. Sidewalks – Alteration. Curb ramps or blended transitions in appropriate locations shall be installed when new sidewalks are constructed in existing rights-of-way, or when existing sidewalks are rebuilt. This also includes any location where the new sidewalk crosses private drives or access points. Selection of the exact means of constructing the installation is left to the property owner. However, an unbroken, compliant PAR shall be installed that crosses the path of private drives and other access points wherever there is a public sidewalk in the right-of-way or in a dedicated easement.

C. Responsibilities:

1. Resurfacing. Resurfacing is defined as milling and filling or overlay of a roadway surface, from edge to edge of pavement of uncurbed roadways, or face of curb to face of curb, across the entire width of that roadway, extending any given length along the roadway. As such, it is considered an alteration, and compliance is required to the maximum extent possible. The scope for any resurfacing project that includes roadway having curbs and sidewalk shall include compliant curb ramps. Further, curb ramps shall be constructed prior to or contemporaneously with such time that actual resurfacing activities are initiated. Any intersections completely or partially affected by resurfacing efforts shall be made compliant. Note: trenching activities which involve partial removal and replacement of pavement over underground construction, without an improvement to the pavement, and without disturbing the curb or PAR, will not require ADA compliance within the project scope.

2. Roadway Improvements – Capital Improvement Projects. If these projects are scoped within existing rights-of-way, they are considered to be an alteration. If additional right-of-way is obtained, they are considered new build or addition, and are subject to full compliance. Scoping for any Capital Improvement Project (CIP) initiated within the limits of the corporate boundary of the City of Columbus that includes curb and sidewalk shall include curb ramps. In addition, any intersections completely or partially affected by CIP work that result in improvements shall be made compliant.

3. **Utility Improvements – Capital Improvement Projects.** If resurfacing (as defined previously in this section) of the roadway results from utility improvements, then curb ramps shall be installed in required locations along the extent of the roadway replacement, as this will be considered an addition or alteration of the existing pavement. These shall be included in the scope of the utility project. If corners of intersections beyond the edge of any curb present (i.e.: outside of the paved area) are disturbed as a result of utility construction activities, affected corners shall be rebuilt compliant. This will include the installation of curb ramps if required. If this results in an “orphan ramp” situation, the utility shall abide by requirements in Section VIII.F of this policy.
4. **Roadway Improvements – Privately Funded.** Any roadway improvements generated as a result of private development projects, such as new turn lanes, new signals, or pavement improvements, shall include as part of the project scope all work that will make any affected intersections compliant. Ultimate responsibility for making these intersections compliant will rest with the developer. This includes the installation of curb ramps and pedestrian accessible controls for walk signals as determined by the Department of Public Service where needed. If this results in an “orphan ramp” situation, the developer shall abide by requirements in Section VIII.F of this policy.
5. **Privately Funded Property Improvements.** In the event that a developer makes improvements to a parcel that occupies one corner of an intersection, the scope for the project shall include construction required to make the corner he or she owns or controls compliant, as well as opposing ramps as needed in order to avoid an “orphan ramp” situation, as determined by the Department of Public Service. Refer to Section VIII.F for requirements pertaining to “orphan ramps.”

VIII. CURB RAMP CONSTRUCTION SCENARIOS

- A. **4-Way Intersections.** All corners at all 4-way intersections that have sidewalks shall be made compliant, except as noted in Section VI.
- B. **3-Way (“Tee”) Intersections.** The decision whether to construct 4 ramps (two pedestrian accessible routes or PARs) or 6 ramps (three PARs) will be based on the following conditions:
 1. Physical constraints are present that would preclude construction of a desired ramp at a given location, as removal or relocation of these obstructions will be prohibitively expensive or would not be practical from a constructability standpoint. These constraints include but are not limited to driveways, utilities, storm structures, mailboxes, or other permanent street furniture. Analysis and final determination of these constraints will be made by the Division of Mobility Options.
 2. Pedestrian traffic volume, based on estimates calculated by the City of Columbus’ “Columbus Pedestrian Thoroughfare Plan Handbook.” In it, roadways have been classified on the basis of predicted pedestrian use, rating from 1 (highest use) to 5 (lowest use). The City is divided into areas that reflect the amount of transit dependent population. This information will be used to decide whether a given intersection will be built with four or six ramps. This criterion is illustrated in Figure 8-1.

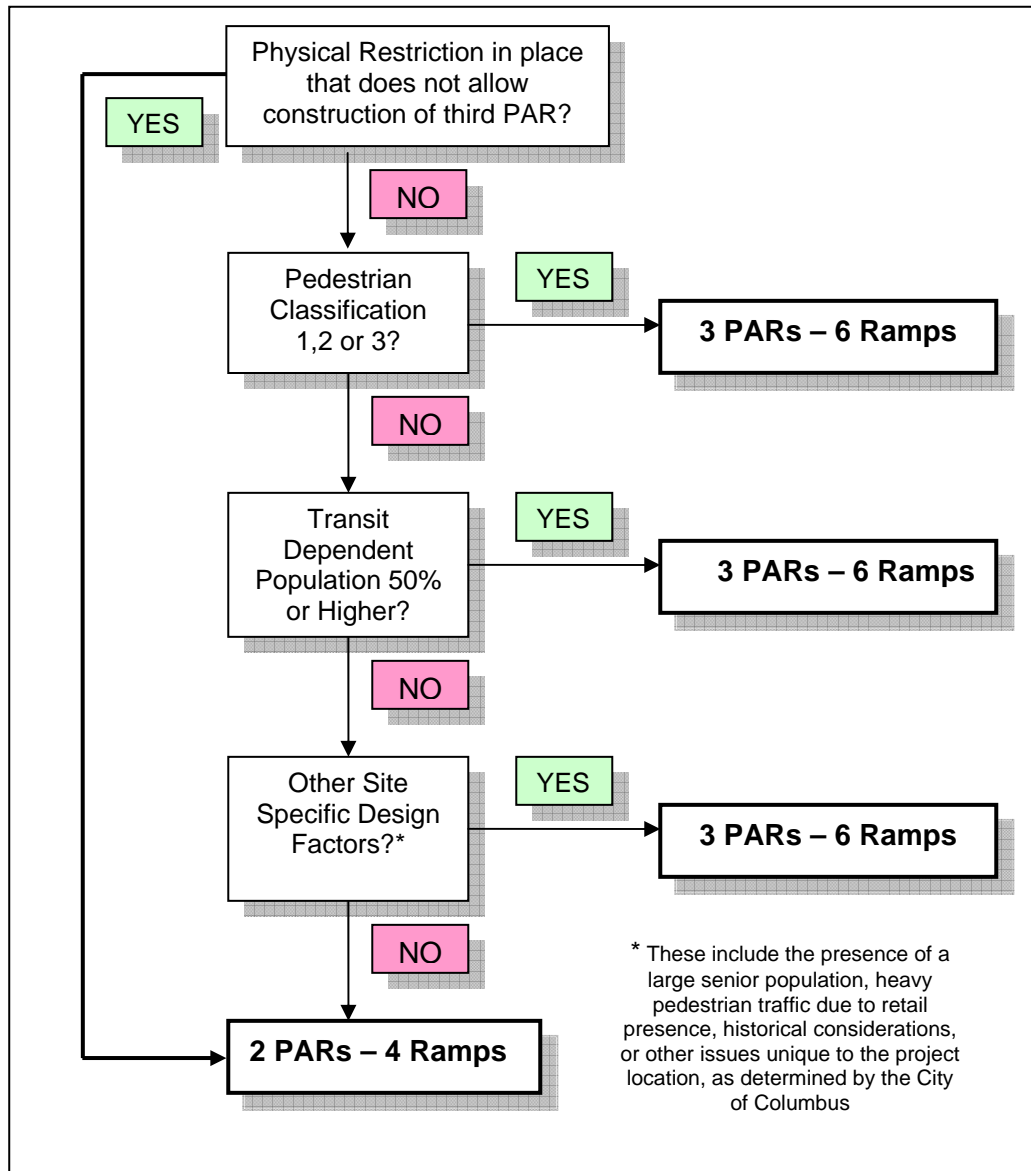

Figure 8-1

3. In the event that four ramps are required, and there is a choice of locations for ramps accessing the PARs crossing the through street, preference will be given for the PAR that does not cross the right-turn movement of the intersecting street, as illustrated in Figure 8-2.

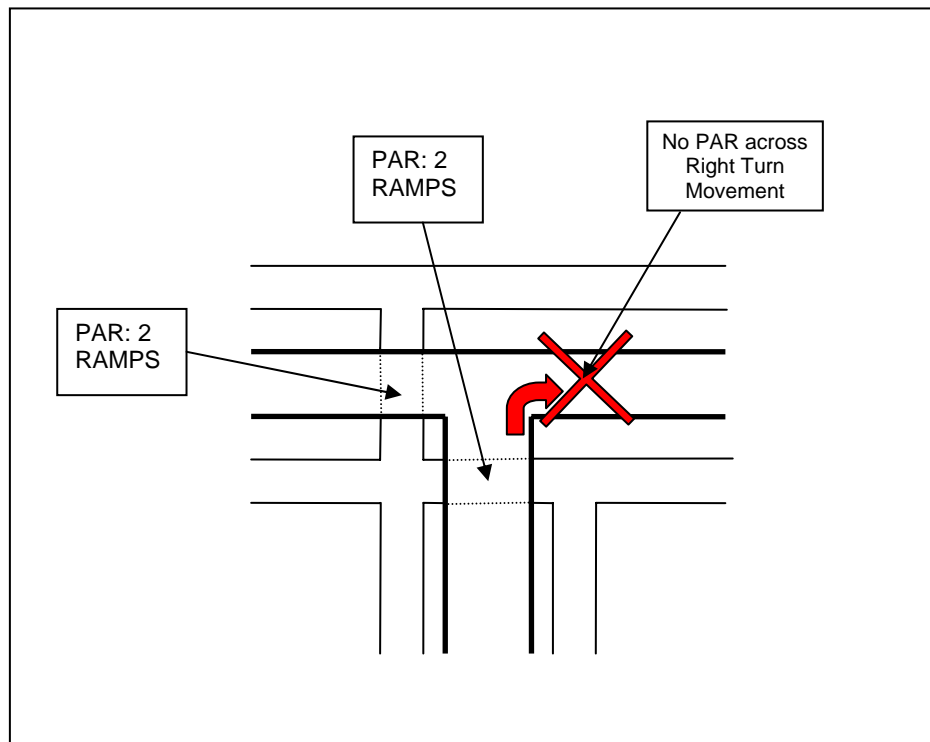

Figure 8-2

4. Removal of Existing PARs - Under certain circumstances, sidewalk may be in place that will allow a crossing at the third leg of an intersection, despite the fact that there is no demonstrated need, either due to pedestrian traffic volumes or to demographic considerations, for a third PAR to be in place. Removal of concrete walk in order to restrict access using this PAR will not be permitted. Instead, six (6) ramps will be constructed.
- C. Offset Streets Scenario.** Under some conditions, an intersection may be “offset”; that is, the centerline of one leg of an intersection may be shifted a significant distance from the centerline of its opposing side. If the offset is 200 feet or less, the intersection shall be treated as a single 4-way intersection, and ramps do not have to be installed within the interior of the offset. Refer to Figure 8-3. If the offset exceeds 200 feet, the intersection shall be treated as two separate “tee” intersections, and, if required under the conditions of the “tee” intersection policy above, all corners shall have ramps. Refer to Figure 8-4.

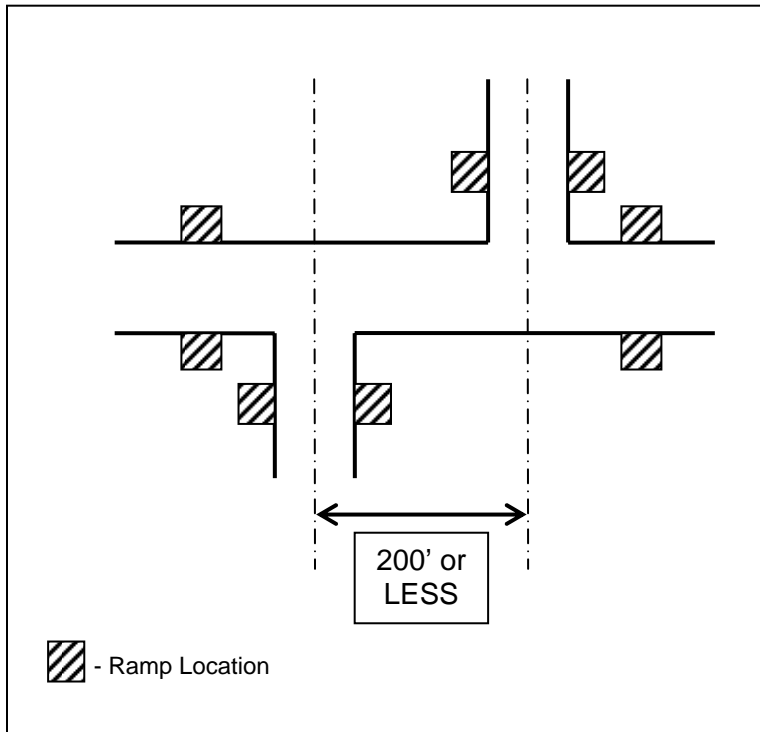

Figure 8-3

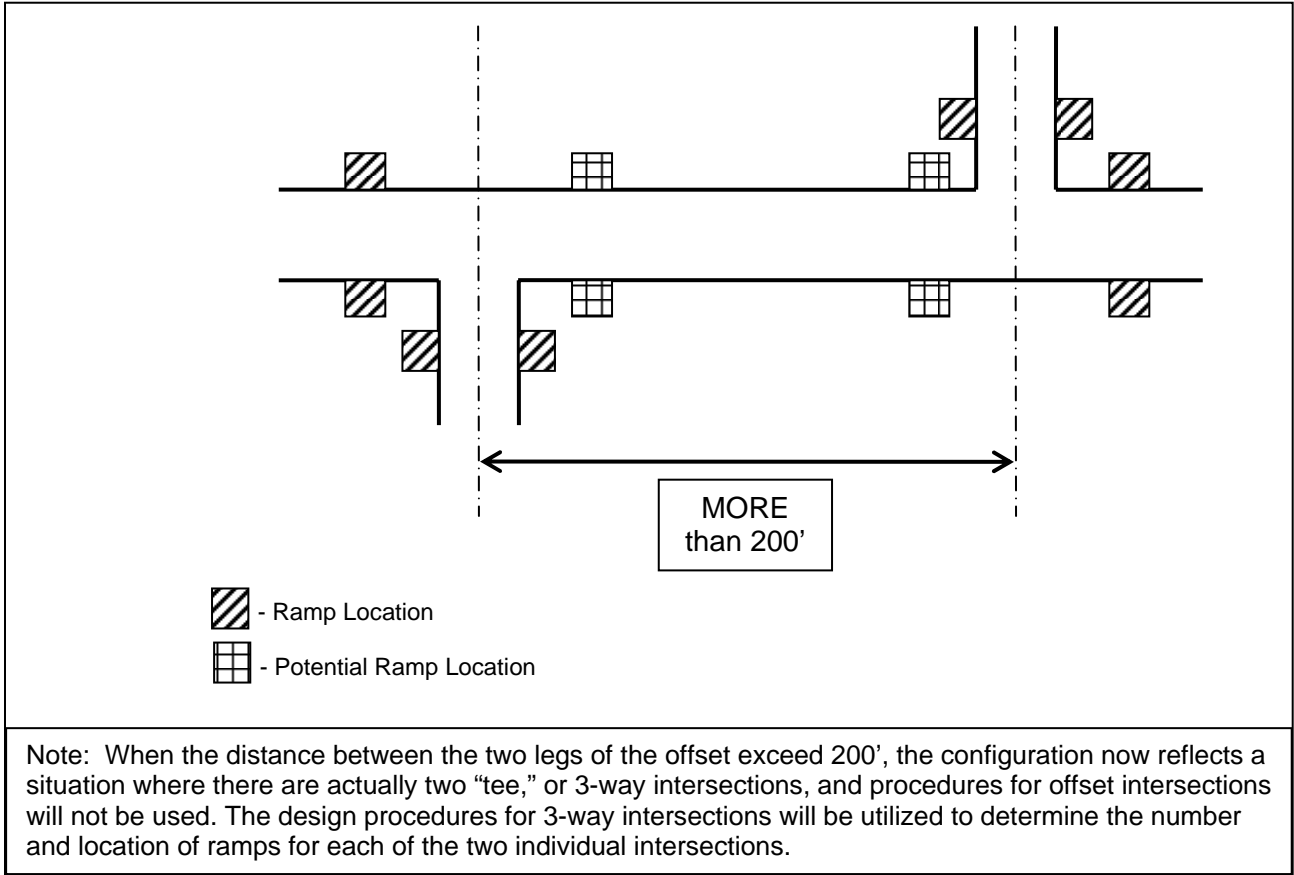

Figure 8-4

- D. Curb Ramps at Alleys.** An alley is a specialized, limited use roadway that provides limited access to the rear of specific properties in a neighborhood or central business district. An intersection of an alley with a street, according to ORC 4511.01 (KK) (3), is not an intersection. This in turn means that there are no legal crosswalks in place that will traverse the street. And, therefore, no PAR crosses the larger street. A PAR does, however, cross the alley, as this entails crossing a City of Columbus right-of-way. Refer to Figure 8-5.

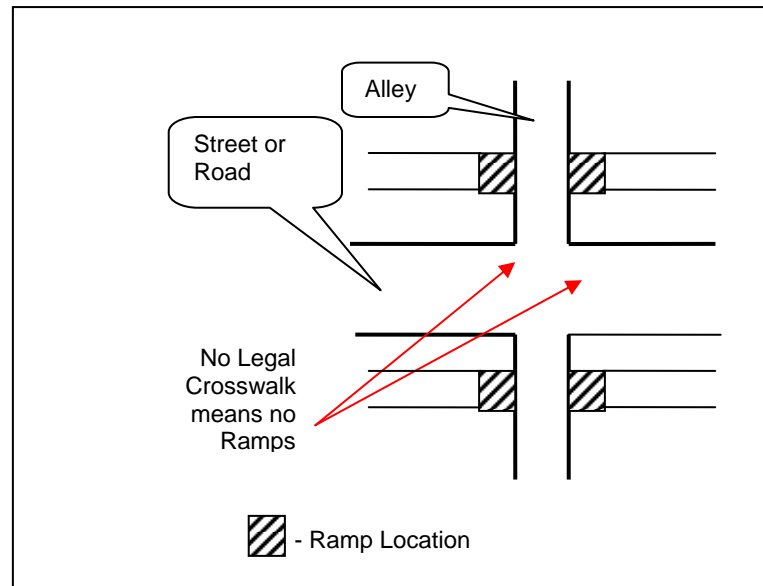

Figure 8-5

- 1. Definitions of Alleys:** According to City of Columbus Code 2101.03, “Alley” means street or highway intended to provide access to the rear or side of lots or buildings in the city and not intended for the purpose of through vehicular traffic, and includes any street or highway that has been declared an “alley” by City Council. This definition is based on ORC 4511.01(XX). Alleys also typically do not serve as the primary frontage for properties along them - any roadway that has buildings that front on that roadway that do not have an alternate primary frontage (i.e., use the alley as the basis for its address) cannot be defined as an alley, even if it has been declared an alley by code or by name.

Curb ramps allowing pedestrians to traverse the major roadway shall be constructed at intersections of alleys and roadways if marked crosswalks are in place traversing that main roadway.

- E. Curb Ramps at Private Driveways.** Unless expressly stated otherwise, construction of curb ramps or blended transitions at privately owned driveways is the responsibility of the property owner or developer, and not the City. Curb ramps and blended transitions in areas having sidewalks will be constructed as part of pavement repair work, and will be triggered when the property owner requests a ROW permit or submits construction plans for review. The property owner will be required to construct all features of the approach located in the city right-of-way according to City of Columbus standards and to ensure that a compliant PAR is constructed across the width of the drive, as stated in City of Columbus and ADA.

Detectable warning units are not required at approaches to driveways serving single family residential units or to duplex residential units. They are required at approaches to driveways providing access to publicly accessible parking areas serving multi-family residential and commercial establishments if the intersection is signalized or has marked crosswalks.

- F. Non-Paired or “Orphan” Ramps.** It is considered best practice to install ramps in pairs, that is, when a ramp is constructed on one side of a street, a ramp will be constructed on the opposite side of the street. This creates a continuous PAR throughout the length of the legal crosswalk, and is done so to prevent stranding disabled persons within the roadway. City of Columbus policy is to prohibit unpaired ramps, and require that, when construction activities affect an intersection, all corners with sidewalks that are impacted by the construction shall have compliant curb ramps installed. No break in a PAR is permitted within a legal crosswalk. Refer to Figure 8-6.

In the event that a construction project impacts one or more corners of an intersection, the scope of the project shall include the following to create a compliant PAR from each corner impacted by construction:

1. Ramp Design: The developer or agency responsible for the project shall provide the complete design of all curb ramps at each intersection impacted by construction. This requirement is necessary to ensure that curb ramps installed with the project are properly designed and located accounting for future curb ramp installations on corners not impacted by the project. The City will maintain the design for future use. At signalized intersections, the design may also include separate pedestrian pushbutton devices. Reasonable costs to design opposing curb ramps and pedestrian pushbuttons may be eligible for reimbursement as described below.
2. Ramp Construction: The developer or agency responsible for the project impacting an intersection shall be responsible for constructing compliant curb ramps and pedestrian pushbuttons to restore all impacted PARs under the following conditions:
 - a) **Non-existent curb ramps on undisturbed opposing corners:** Where a sidewalk is present, but no ramp exists at the opposite end of each crosswalk at intersection corners impacted by the project, the developer or agency shall be responsible for the construction of those ramps, in addition to the curb ramps at the intersection corner(s) disturbed by the project. The developer or public agency may request reimbursement for the reasonable cost of construction, bonding and design of non-paired ramps according to Section VIII.F.3.
 - b) **Non-compliant curb ramps on undisturbed opposing corners:** Where a non-compliant curb ramp exists at the opposite end of each crosswalk at intersection corners impacted by the project, the City shall be responsible for the cost of constructing the replacement of the non-compliant curb ramps. The developer or agency shall be responsible for the construction of compliant ramps at the intersection corner(s) disturbed by the project and the design of opposing ramps to ensure that the ramps

to be built by the developer or agency shall be properly located. At its discretion, the City may establish a design and construction reimbursement from any future developers of the property abutting the non-compliant ramps for up to ten (10) years following replacement of the non-compliant ramps.

Reimbursement: The cost of designing, constructing and bonding curb ramps and pedestrian pushbuttons on opposing corners constructed according to Section VIII.F.2 may be eligible for reimbursement. The developer or public agency responsible for these eligible curb ramps shall request in writing on forms provided by the Division of Mobility Options Administrator reimbursement of reasonable design and construction costs for the eligible curb ramps and pedestrian pushbuttons at the time of site plan approval for the project. If development or redevelopment of a property abutting an eligible curb ramp occurs within ten (10) years after final acceptance of the eligible curb ramps, the developer of the property shall reimburse the reasonable design, bonding and construction cost to the developer or public agency responsible for the construction of the eligible curb ramp and pedestrian pushbuttons. Development or redevelopment shall constitute either the construction of new building(s), or the expansion of existing building(s) by more than 50 percent, or any construction activity that disturbs the intersection corner at which an eligible ramp is located. The Department of Public Service shall be responsible for administering the reimbursement program.

- 3. Appeals:** The Division of Mobility Options Administrator reserves the right to disallow requests for reimbursement of curb ramp construction costs, dependent on circumstances unique to a given project. If the Division of Mobility Options Administrator disapproves a request for reimbursement, the developer or public agency has the right to appeal the decision as follows:
 - a.** Request a hearing of the Transportation and Pedestrian Commission (T&PC) at the next scheduled meeting date, in writing, within 14 days of receipt of the disapproval or denial.
 - b.** The Division of Mobility Options Administrator will forward his/her denial along with the recommendation of the T&PC to the Director of Public Service for review.
 - c.** The Director of Public Service will render a final decision within 14 days of the T&PC hearing.

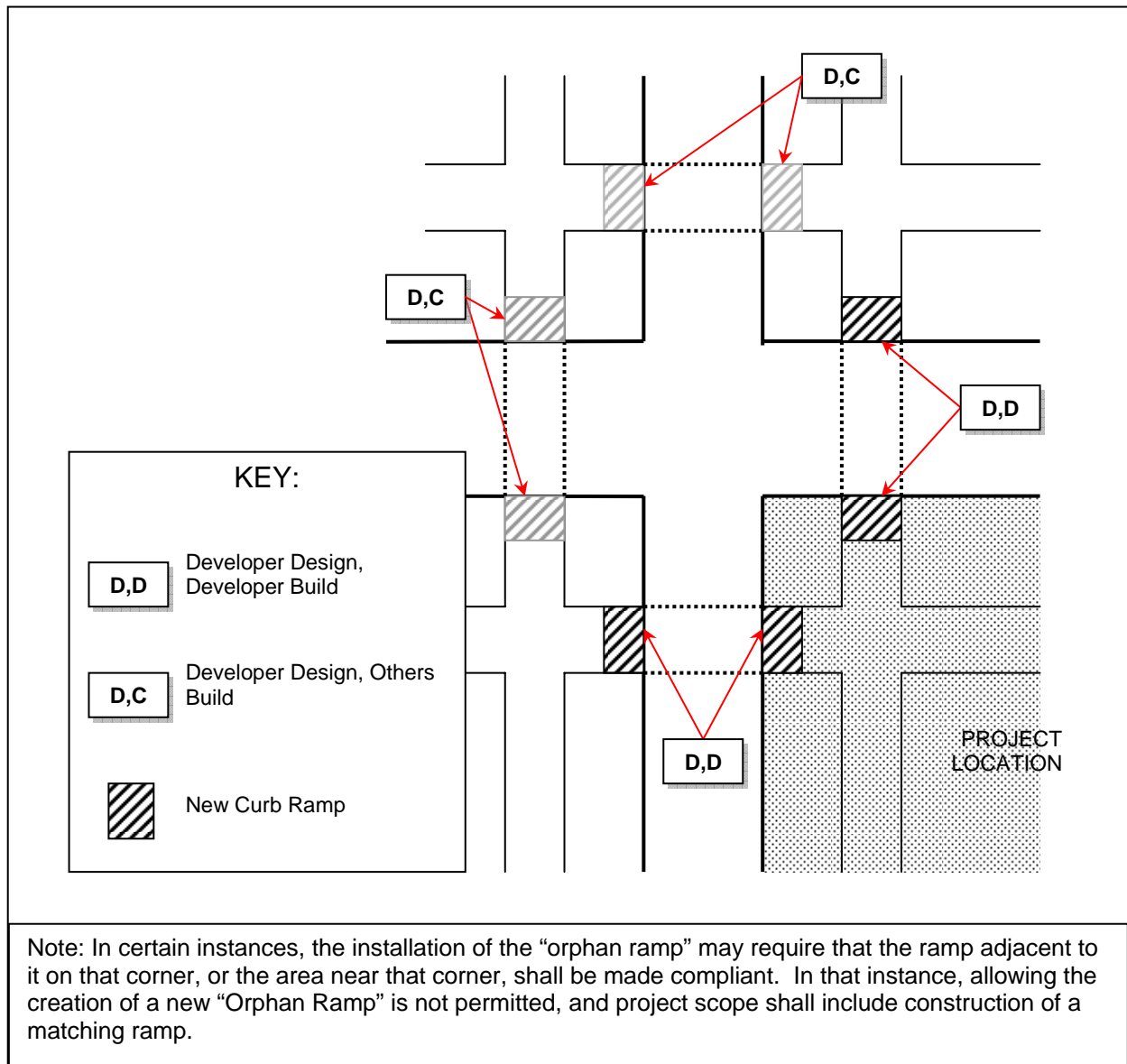

Figure 8-6

IX. RAMP REQUEST DOCUMENTATION AND RATING SYSTEM

A. General Guidelines. Ramp priorities are documented based on a two digit numbering system:

XY

The “X” numeral refers to the **TYPE** of ramp request:

- 1. Requests from individuals, usually via 311 calls**
- 2. Unmatched or “Orphan” Ramps**
- 3. Maintenance generated issues.**

The “Y” numeral refers to the **RELATIVE PRIORITY** of each request, with “1” being the most critical and “3” being the least. A detailed description for each type and priority follows:

1. **Requests for Ramps from Individuals (311 calls).** The City of Columbus receives requests for curb ramp installations at various locations throughout the City. These are typically handled through the 311 system, and the information is recorded by the Division of Mobility Options ADA Coordinator. These ramp requests are categorized on the basis of a priority system, as follows:
 - a. **Priority 1 – Ramp Code 11** - Request is for a ramp that is necessary in order to immediately meet Federal guidelines, or is mandated by the terms of the City’s consent decree. Examples of these ramps would be those that provide access to government buildings or facilities, or those that should have been done as part of repaving projects, but were missed.
 - b. **Priority 2 – Ramp Code 12** - The ramp request is made by or in behalf of a disabled individual or individuals who will directly benefit from installation of a particular ramp.
 - c. **Priority 3 – Ramp Code 13** - All other ramp requests.

These ramps will be constructed as part of repaving projects, CIP projects, or as part of annual “On Call” ramp construction projects.

2. **Unmatched or “Orphan” Ramps.** These ramp needs are described in Section VI. Priorities are as follows:
 - a. **Priority 1 – Ramp Code 21 - High Priority** – Ramp needed to complete passage through a legal crosswalk, either marked or unmarked. Also: dangerous condition or site where accidents have occurred and have been documented.
 - b. **Priority 2 – Ramp Code 22 - Medium Priority** – Ramp not needed to complete crosswalk, yet is needed to complete all required ramps at a given intersection. There is no history of accidents, but the location is not scheduled for a resurfacing or CIP project that would address the missing companion ramp within the next 2 years. Also: sites located in areas having a high population of disabled persons or high population of transit dependent persons.
 - c. **Priority 3 – Ramp Code 23 - Low Priority** – Ramp not needed to complete crosswalk, yet is needed to complete all required ramps at a given intersection. Resurfacing project or CIP project scheduled to remedy orphan ramp situation within 2 years, or ramp is not located within an area having a high population of disabled persons.
3. **Maintenance Issues of Curb Ramps.**
 - a. Priorities are as follows:
 1. **Priority 1 – Ramp Code 31 - High Priority** – Ramp is non-compliant and is damaged such that it has one or more significant problems. Documented accidents have occurred.
 2. **Priority 2 – Ramp Code 32 - Medium Priority** – Same as above, but no documented accidents have occurred.
 3. **Priority 3 – Ramp Code 32 - Low Priority** – Non-compliant ramp, but there are no evident conditions that make it dangerous for disabled persons to use.
 - b. Repair issues considered significant and that make the ramp dangerous for disabled persons to use include but are not limited to the following:

1. Gaps of ½” or greater
 2. Heaving of concrete sections creating cross-slopes in excess of 2%
 3. Heaving of concrete sections creating longitudinal slopes in excess of a 1/12 slope ratio
 4. Settling or other conditions creating a vertical drop of ¼” or more anywhere along the ramp
4. **Location of Curb Ramps within Intersections.** Curb ramps at street intersections are to be located within the “Design Boundary” as shown in Figure 9-1.

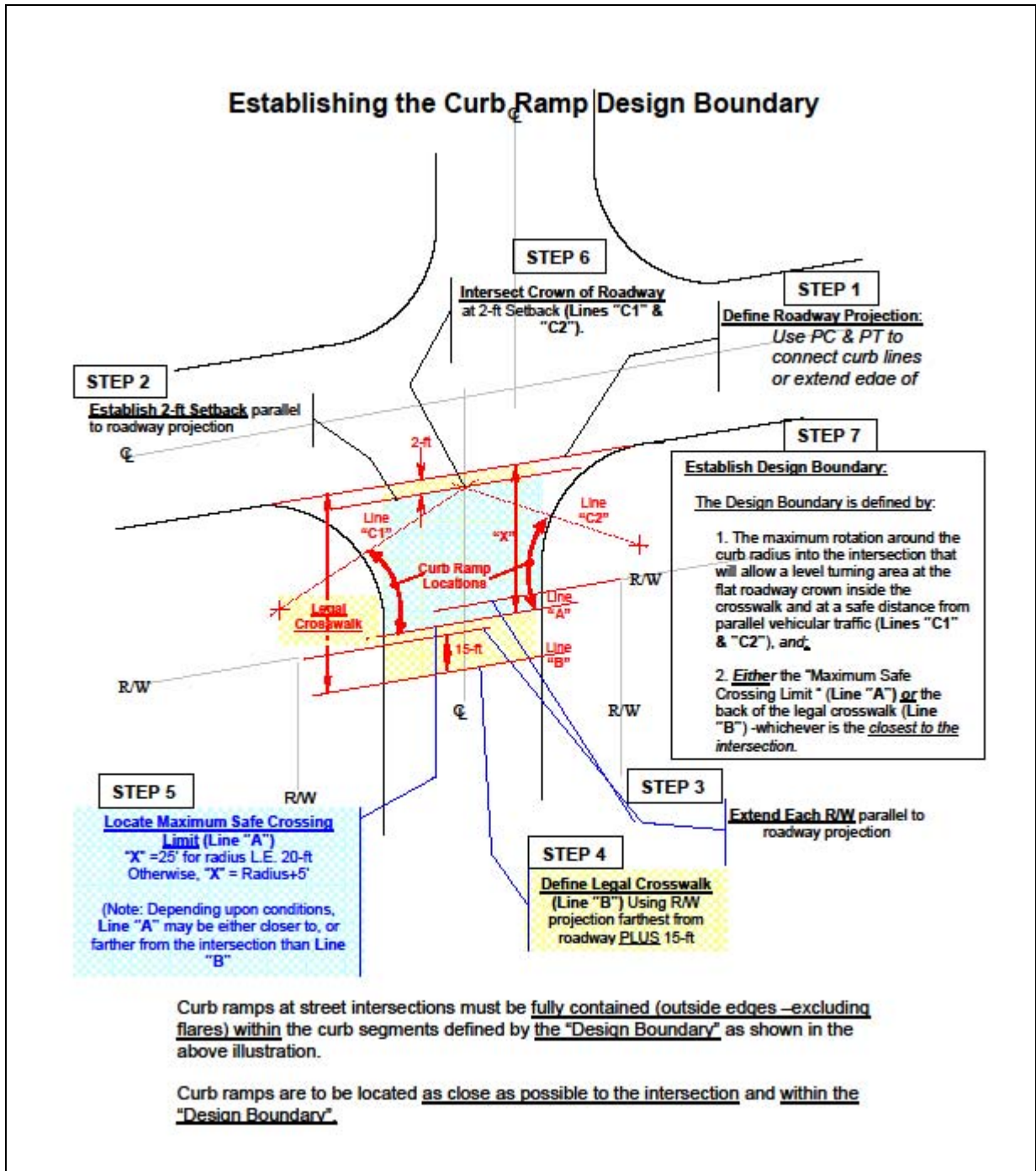

Figure 9-1

X. TYPES OF CURB RAMPS

There are a number of different curb ramp styles available for design. Certain styles are preferred as they provide better mobility options for disabled persons, as well as being able to handle other inherently structural problems, such as drainage, better than others.

- A. Perpendicular Curb Ramps.** These ramps are the preferred style for City of Columbus projects and for private street projects. These are represented by Type “A”, Type “C”, and Type “D” ramps in the City of Columbus Standard Drawings. Perpendicular curb ramps have a running slope that cuts through the curb at right angles or meets the gutter grade break at right angles. Perpendicular ramps may also be installed at curved sections of curb near intersections. They are installed perpendicular to the arc scribed by the curb. Care must be taken to ensure that this perpendicular property is followed, so as to avoid a skewed ramp condition.

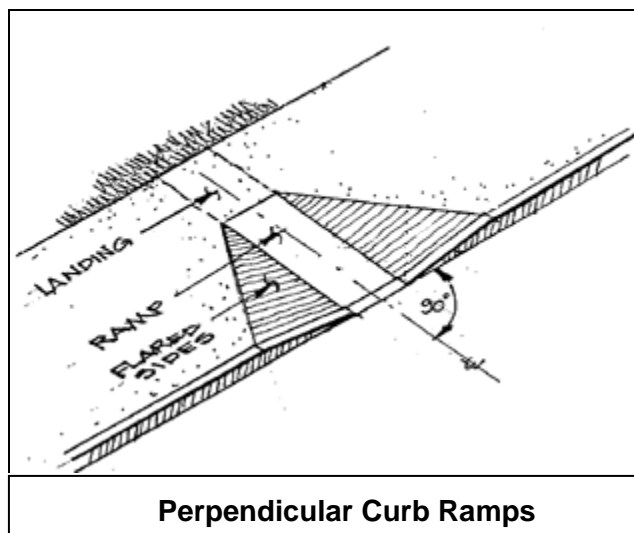

Figure 10-1

- B. Parallel/Combination Curb Ramps.** A variation of the parallel ramp style is allowed by the City of Columbus. It is represented by the Type P-1 and Type P-2 ramps in the City of Columbus Standard Drawings. These are secondarily preferred, mainly due to drainage issues inherent to the design. Parallel curb ramps shall have a running slope that is in-line with the direction of sidewalk travel.

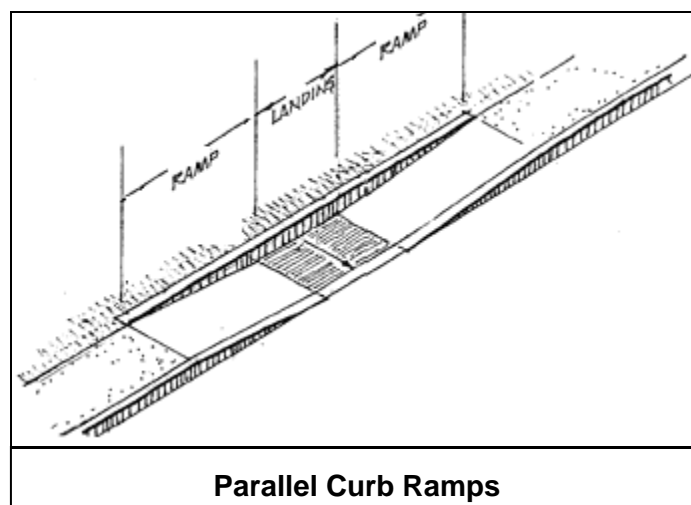

Figure 10-2

- C. **Diagonal (Shared) Curb Ramps.** Diagonal or “Shared” ramps are a variant of the perpendicular type because it also cuts the curb line at right angles. A diagonal ramp is located at the midpoint or apex of the curb radius or return and serves two crossing directions with a single cut. These ramps are generally prohibited in City of Columbus projects, but when they are allowed, they are to be used ONLY in alterations and ONLY with the approval of the City of Columbus Director of Public Service of designee. Otherwise two ramps are to be constructed at each corner.

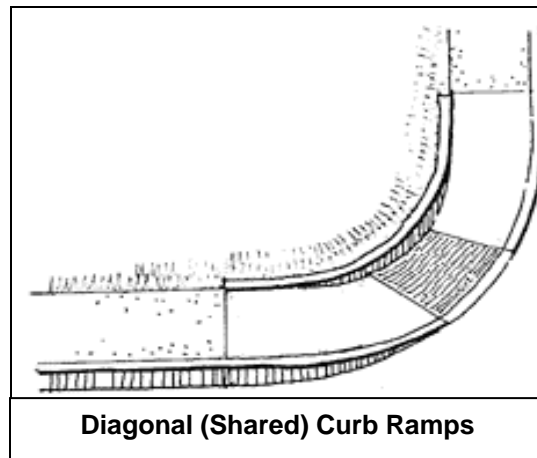

Figure 10-3

- D. **“Skewed” Curb Ramps.** Skewed ramps are not permitted. It is important for manual chair users to approach the base or toe of the ramp straight on when ascending. This permits the user to take advantage of forward momentum from the street crossing. If the curb ramp is skewed to the curb, it will be necessary to turn while ascending - a difficult and taxing maneuver. If the chair user avoids this by entering the ramp at an angle to the change in slope, balance and control are compromised. When all four wheels of a wheelchair or scooter are not in contact with the rolling surface, maneuverability and control are lost. Because the downhill slope of a ramp ends in the street, a loss of control may have serious safety effects. Therefore, in order to provide a straight run to the top of the ramp from the street, curb ramps shall always to be perpendicular to the curb it cuts.

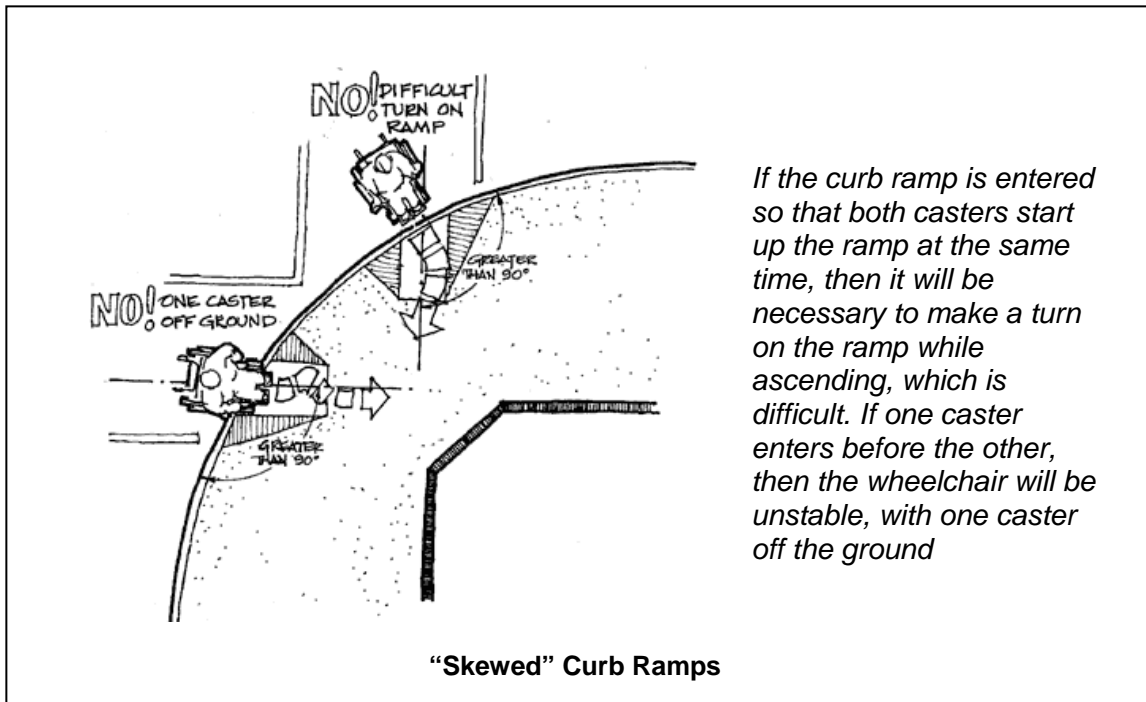

Figure 10-4

- E. Modified “Skewed” Curb Ramps.** The City of Columbus maintains a standard drawing for modified skewed ramps, Types “G” and “H”. These ramps are set up in such a way that the bottom of the approach is level, meaning that the two front wheels of a wheelchair will touch the level surface of the roadway simultaneously. There are a number of shortcomings with this ramp, including difficulties with drainage and problems with tying it in to sidewalk approaching from another direction. Therefore, this ramp is restricted to use at alleys and private drives, and in situations where lack of ROW makes it impossible to use any other more preferred ramp.

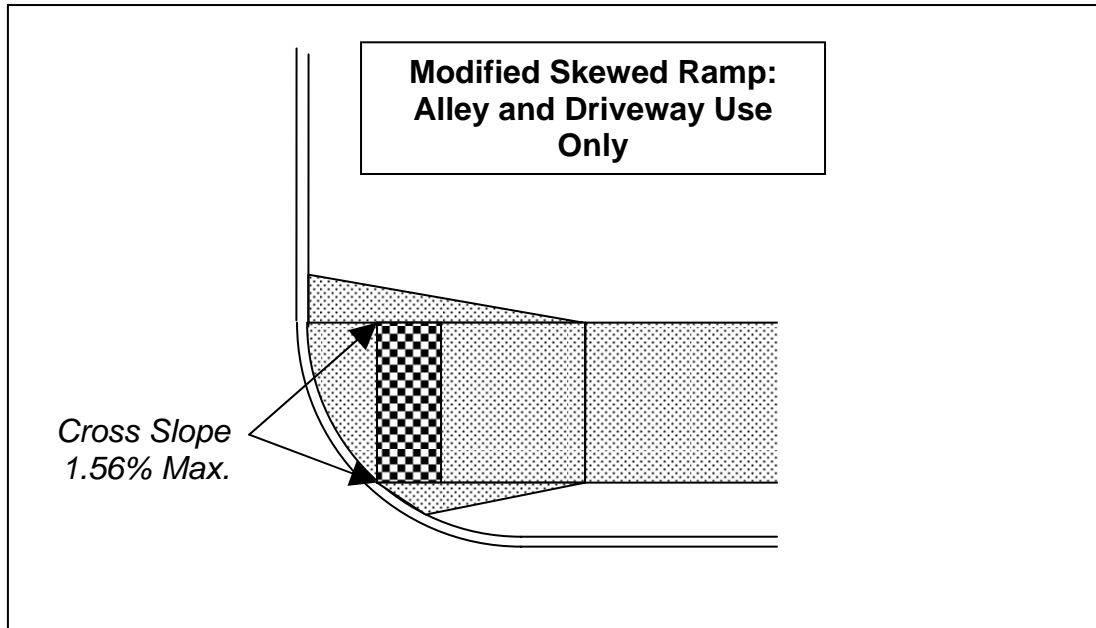

Figure 10-5

XI. GENERAL RAMP REQUIREMENTS

- A. Running Slope.** This is the slope that runs parallel to the direction of travel along a ramp.

City of Columbus Standard

- Running slope maximum: 1:13 or 7.69%

Federal Standards

- Running slope maximum: 1:12 or 8.33%
- Running slope minimum: 1:48 or 2.08%

Note: the running slope may run downwards toward the street, which is typical, or, in rare circumstances, it may run upward toward the street. Both situations are permitted, as long as the running slope does not exceed the maximum standards.

EXCEPTION: A combination/parallel curb ramp shall not be required to exceed 15 feet (4570 mm) in length.

Inspection Guidelines and Construction Tolerances: Ramps are to be designed and constructed to the 1:13 running slope maximum. If an ensuing inspection notes that this standard has not been met, yet the slope of the ramp does not exceed the Federal standard of 1:12, the ramp may be approved, provided it does not violate other ramp design and construction standards established by the City of Columbus.

- B. Cross Slope.** This is the slope that runs perpendicular to the direction of travel down a ramp. It also applies to landings or other level surfaces of a curb ramp.

City of Columbus Standard

- Cross slope maximum: 3/16" per foot or 1.56%

Federal Standards

- Cross slope maximum: ¼" per foot, 1:48, or 2.08%

EXCEPTION: This requirement shall not apply to mid-block crossings.

Inspection Guidelines and Construction Tolerances: Ramps are to be designed and constructed to the 1.56% cross slope maximum. If an ensuing inspection notes that this standard has not been met, yet the slope of the ramp does not exceed the Federal standard of ¼" per foot, or 2.08%, the ramp may be approved, provided it does not violate other ramp design and construction standards established by the City of Columbus.

- C. Landing.** A landing 48 inches minimum by 48 inches (1220 mm) minimum shall be provided at the top of perpendicular curb ramps and at the bottom of a parallel curb ramp run and shall be permitted to overlap other landings and clear floor or ground space. General cross slope standards apply.
- D. Long Flares.** On perpendicular curb ramps, flared sides no shorter than 10-times the curb height, measured along the curb line, shall be provided where a circulation path or walkable surface crosses the curb ramp.
- E. Short Flares.** These are commonly 12" or wider, up to 5', at the curb, and are used at locations where there is no walkable surface adjacent to the ramp. Non-walkable surfaces may be grass, trees, landscaping, areas blocked by utility poles or street furniture, etc. Manhole covers and hatches are considered to be walkable surfaces, if they are flush with the sidewalk surface. Short flares should never to be used at any location where pedestrian traffic can be expected to cross them.

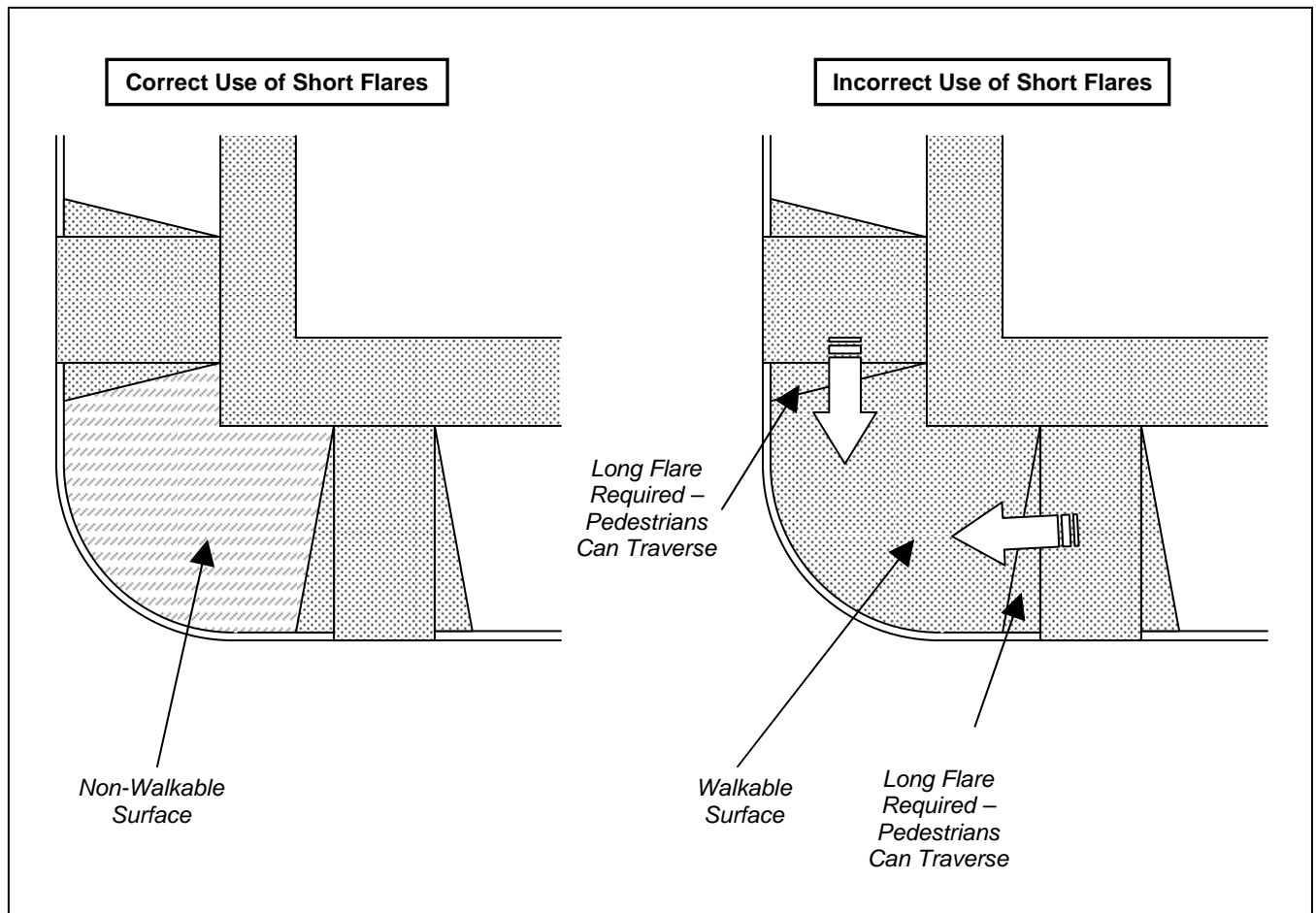

Figure 11-1

- F. **Blended Transitions.** These are transitions from sidewalk into a non-curbed section of pavement, usually a private drive or entrance. Blended transitions shall have running and cross slopes of 1:48 maximum. Note that these are not considered to be curb ramps for payment purposes.
- G. **Width.** The clear width of landings, blended transitions, and curb ramps, excluding flares, shall be 48 inches minimum.
- H. **Detectable Warnings.** Detectable warning surfaces shall be provided in many conditions where a pedestrian path crosses a vehicular way. These conditions as well as other requirements are noted in Section XI and elsewhere in this document and to the specifications set forth in the City of Columbus Standard Drawing 2319 Dr. A.
- I. **Surfaces.** Surfaces of curb ramps, blended transitions, and landings shall comply with Section 302 of the ADA ROW Design Guidelines (2005 edition). Gratings, access covers, and other appurtenances shall not be located on curb ramp landings or slopes, blended transitions, and gutter areas within the pedestrian access route. However, these items may be allowed within sections of the pedestrian accessible route, including flares, provided they comply with requirements set forth for PAR surfaces, in "Guidelines for Accessible Public Rights-of-Way", Section 301.

- J. **Grade Breaks.** Grade breaks shall not be permitted on curb ramps, blended transitions, landings, and gutter areas within the pedestrian access route. Surface slopes that meet at grade breaks shall be flush. Grade breaks shall be perpendicular to the direction of travel and shall be no closer than 2-feet apart.
- K. **Changes in Level (“Lips”).** Vertical changes in level (“lips”) greater than ¼” shall not be permitted on curb ramps, blended transitions, landings, or gutter areas within the pedestrian access route.
- L. **Counter Slopes.** The counter slope of the gutter area or street at the foot of a curb ramp or blended transition shall be 1:20 or 5% maximum for a minimum distance of 2-feet from the bottom of the ramp.

XII. DESIGN AND CONSTRUCTION PROCEDURES

Projects involving ramps can put into the following categories:

- Resurfacing
- Transportation Capital Improvement Projects
- Other City Capital Improvement Projects
- Private Development

A. **Resurfacing Projects:** Two procedures are available for preparation of contract documents for resurfacing projects involving ramps:

1. **Design**
2. **Design/Build**

1. **Design.** In this process, an engineering firm is assigned to develop construction drawings for each intersection involved in a given project. No formal survey work is done, and there is little or no elevation information unless conditions exist or will exist that requires a higher level of topographic control (see Figure 12-1). The engineer uses GIS information, supplemented by field inspections and records research. Curb ramp types are selected and are laid out in Auto CAD, based on local conditions. Plans are submitted to the Division of Mobility Options, where they are reviewed and returned as needed. This system is preferable when the project areas have numerous design and construction challenges, such as underground vaults, limited right-of-way, utility conflicts, and terrain challenges.

2. **Design/Build.** For this type of contract, the contractor is supplied with sketches, or worksheets, of each intersection, all derived from publicly available GIS information. The line type information (i.e., rights-of-way, surface utilities, edge of pavement, etc.) is typically superimposed on aerial orthographic photos of the site. The contractor will lay out ramps on the worksheets and submit them to the Division of Mobility Options for approval. This procedure works well in areas where there are few design challenges, and saves costs by eliminating the need for an engineer. It also works well when the contractor has extensive experience in ramp layout and construction. It is not recommended when the construction contractor does not have experience.

- B. Transportation Capital Improvement Projects, Other City Capital Improvement Projects, Private Development:** An engineering firm is assigned to develop construction drawings for each intersection involved in a given project. No formal survey work is done, and there is little or no elevation information unless conditions exist or will exist that requires a higher level of topographic control (see Figure 12-1). The engineer uses GIS information, supplemented by field inspections and records research. Curb ramp types are selected and are laid out in Auto CAD, based on local conditions. The ramp designs are included as part of the public improvement plans, following established plan review procedures for the specific plan type. While this process is preferable when the project areas have numerous design and construction challenges, such as underground vaults, limited right-of-way, utility conflicts, and terrain challenges, some ramp designs may require a higher level of detail if topography, obstacles or other elements of the existing environment or the proposed project elements require more accurate layout information. In this case, an additional process, **full design**, shall be used. This is similar to the **design** process, except that formal survey work is done for each intersection. This allows for much more accuracy, plus detailed ramp and sidewalk slopes and grading can be determined, as elevation information is available to the engineer. Spot elevations may be shown on plans as needed. However, this will be used sparingly, and only to indicate important control elevations.

The illustration on the next page demonstrates major concepts expected in construction drawings of curb ramps.

Notes: Major Concepts

1. Reference City of Columbus Standard Drawings to indicate ramp types and for other construction components whenever possible. In the event that a specialized ramp design unique to the project is required, provide a detailed drawing of that ramp with sufficient horizontal control and slope information for use by the contractor.
2. Use spot elevations only as necessary, and at controlling elevations. Do not use for construction unless absolutely necessary. Ramp standard drawings will provide guidance for vertical control needed for construction.
3. Use dimensioning for horizontal control as needed for construction.
4. Use flow arrows to illustrate drainage patterns and to indicate prevailing associated slope.
5. Indicate right-of-way, easement locations, and other legal boundaries applicable to construction activities.

Important note: The referenced figure is not intended to represent a bone fide portion of a construction drawing. Instead, its purpose is to illustrate the five major concepts expected from construction drawings that involve ramp design. The complexity of submitted construction drawings will vary depending on the individual characteristics of each project.

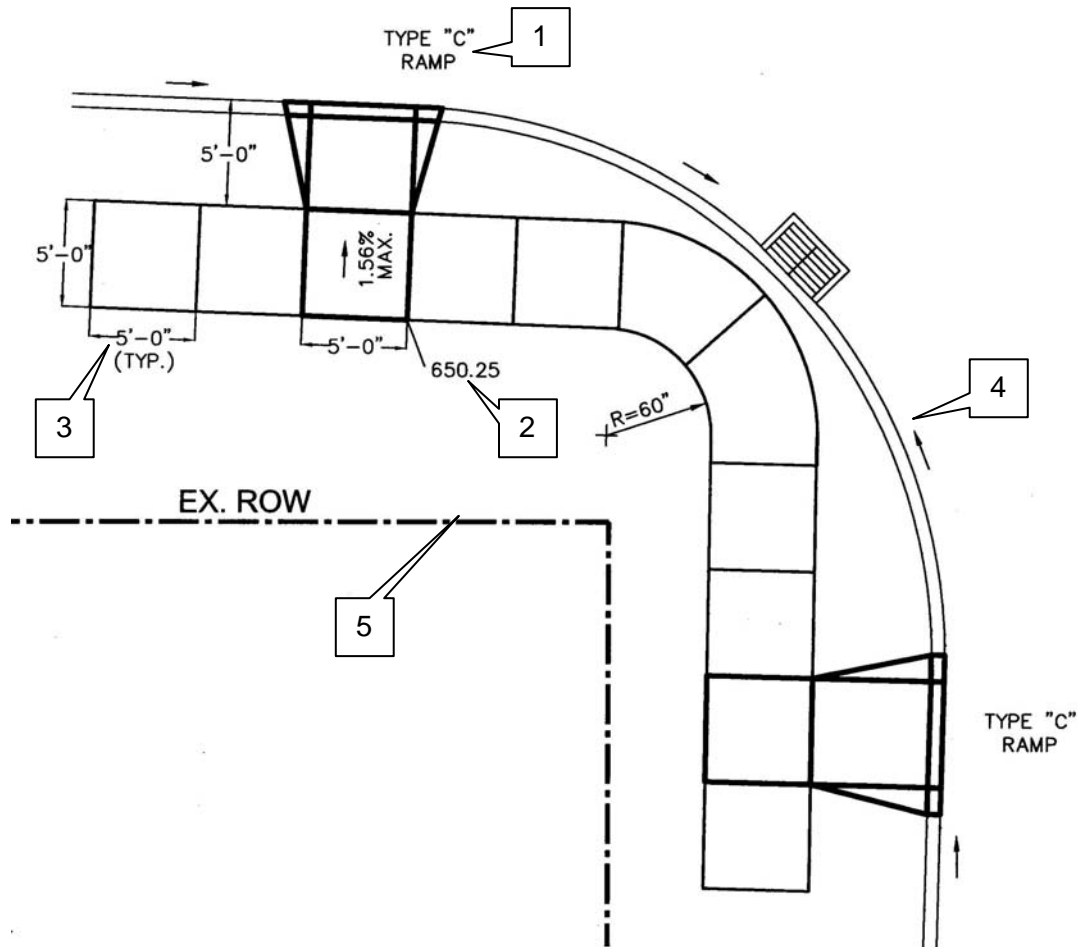

Figure 12-1

XIII. OTHER ELEMENTS

A. Detectable Warning Units

1. **General.** Detectable warnings shall consist of a surface of truncated domes complying with City of Columbus Standard Drawing 2319, and Supplemental Specification #1551. Detectable warnings provide a distinctive surface of truncated domes detectable by cane or underfoot to alert people with vision impairments of the transition to vehicular ways. These warnings compensate for the sloped surfaces of curb ramps which remove a tactile cue provided by curb faces. ADAAG, as originally published in 1991, contained a requirement for detectable warnings on the surface of curb ramps and other locations where pedestrian ways blend with vehicular ways without tactile cues. This requirement was temporarily suspended due to concerns raised about the specifications, the availability of complying products, maintenance, usefulness, safety, and the need for further study. The suspension expired in July 2001, and the City of Columbus requires their use. Detectable warnings shall be on the list of products approved by the City of Columbus.

2. Where Required. Detectable Warnings (“truncated domes”) shall be used to mark the street edge where a pedestrian path crosses a vehicular way accessible to the public (see exceptions listed on in Section IV). Blind persons traditionally have used the curb as a wayfinding device that indicates the edge of pavement. As a rule of thumb, detectable warnings are to be installed in any situation where curb has been replaced with a level surface in order to allow persons having mobility disabilities to access crosswalks or other pavement areas. Detectable warnings shall be included in all connections to pedestrian streets (both public and private) and alley crossings and at all signalized/stripped commercial driveways. This requirement exists whether-or-not the pathway is sloped to the roadway surface (curb ramp) or level (street-level transition). Detectable warnings are not normally required where sidewalks cross unmarked, non-signalized driveways or commercial drives. However, if such a crossing presents a hazard to pedestrian safety, the City may require that detectable warnings be used.

Detectable warnings are used and shall be included to mark the following features:

- Curb ramps;
- Street-level transitions;
- Borders of medians and islands;
- Depressed corners;
- Borders of raised crosswalks and raised intersections;
- Street crossings for shared-use paths, and;
- Sidewalks crossing railroad tracks.

3. Dome Size. Truncated domes in a detectable warning surface shall have a base diameter of 0.9 inches (23 mm) minimum to 1.4 inches (36 mm) maximum, a top diameter of 50% of the base diameter minimum to 65% of the base diameter maximum, and a height of 0.2 inches (5 mm).

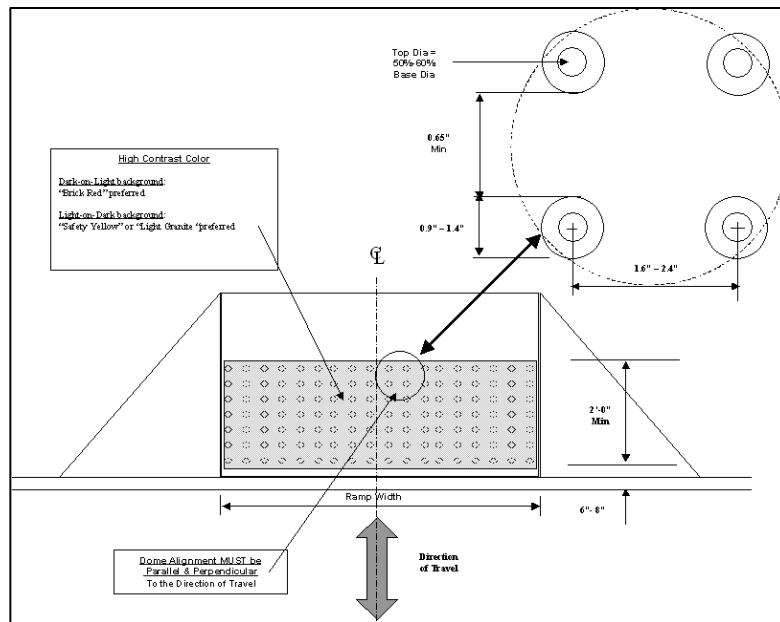

Figure 13-1

4. **Dome Spacing.** Truncated domes in a detectable warning surface shall have a center-to-center spacing of 1.6 inches (41 mm) minimum and 2.4 inches (61 mm) maximum, and a base-to-base spacing of 0.65 inches (16 mm) minimum, measured between the most adjacent domes on square grid.
 5. **Contrast.** Detectable warning surfaces shall contrast visually with adjacent walking surfaces either light-on-dark, or dark-on-light. The City of Columbus requires that the color of detectable warning units closely matches or is identical to Federal Standard 595-B code 12144 or 22144, brick red. In all instances, detectable warning units shall be installed in such a way that the unit is surrounded by a border of concrete. No color substitutions are permitted without the express written consent of the Mobility Options Administrator. Under no circumstances are detectable warning units to be installed directly upon brick sidewalks or pathways, as this would not allow proper contrast between the detectable warning unit and the background material.
 6. **Alignment.** Domes shall be aligned on a square grid in the predominant direction of travel to permit wheels to roll between domes. Domes shall **not** be skewed diagonally.
 7. **Size.** Detectable warning surfaces shall extend 24 inches (610 mm) minimum in the direction of travel and the full width of the curb ramp, landing, or blended transition.
 8. **Location - Curb Ramps and Blended Transitions.** The detectable warning surface shall be located so that the edge nearest the curb line is 6 inches (150 mm) minimum and 8 inches (205 mm) maximum from the curb line.
 9. **Location - Rail Crossings.** The detectable warning surface shall be located so that the edge nearest the rail crossing is 6 inches (150 mm) minimum and 8 inches (205 mm) maximum from the vehicle dynamic envelope.
 10. **Location - Platform Edges.** Detectable warning surfaces at platform boarding edges shall be 24 inches (610 mm) wide and shall extend the full length of the platform.
 11. **Location – Shared Used and Combined Trails.** Detectable warnings shall be placed along the entire width of the trail where it intersects with the roadway edge.
- B. Pedestrian Pushbuttons or Accessible Pedestrian Signals (APS)**
1. **General.** Push buttons shall be mounted so that the face of the pushbutton is no closer than 30 inches from the face of the curb.

EXCEPTION: The minimum distance of 30" from the face of the curb may be reduced for push buttons located in medians and islands.

Push buttons shall be mounted so that the face of the pushbutton is no further than 10 feet from the face of the curb.

ADVISORY: Where no curb exists, this distance shall be measured from the edge of the gravel shoulder or berm farthest from the roadway. Where neither a curb, shoulder nor berm exists, distance shall be measured from the outside edge of the roadway (Figure 13-2).

EXCEPTION: The 10-foot maximum distance shall be waived if the length of the curb ramp, including a 4-foot landing or “clear ground space”, exceeds 10 feet.

Where push buttons are used to cross both streets at the same corner, a minimum separation of 10 feet shall be maintained (Figure 13-3).

EXCEPTION: The minimum distance from other push buttons shall not apply to push buttons located in medians and islands.

Push buttons shall not be located in the ramp slope or flares (Figures 13-2, 13-4, & 13-5).

Push buttons may be located in the ramp landing or pedestrian walkway provided that the clear width of the Pedestrian Access Route (PAR) is not restricted to less than 48 inches (Figures 13-2, 13-3, & 13-5).

- 2. Mounting Height.** A Push button mounting height of 42 inches is preferred (Figure 13-6). Push buttons shall be mounted at a height not lower than 36 inches (Figure 13-6) and not higher than 44 inches (Figure 13-6).

ADVISORY: Push button height shall be measured vertically from the centerline of the push button to the surface of the ramp landing (Figure 13-6).

- 3. Size and Contrast.** Pedestrian pushbuttons shall be a minimum of 2 inches across in one dimension and shall provide a high visual contrast with their housing or mounting. Housings shall provide a high visual contrast with mounting poles or supports. Color and contrast shall be in conformance with all applicable state, federal and local requirements.
- 4. Reach & Proximity.** Push buttons shall be located no more than 10 inches behind the curb ramp landing (Figures 13-2 & 13-5).

At perpendicular curb ramps, push buttons shall be located either behind the ramp landing or to the side of the landing farthest from the street intersection (Figure 13-2). At perpendicular curb ramps, push buttons shall be located no more than 24 inches beyond the curb ramp landing (Figure 13-2).

- 5. Orientation.** If push buttons are mounted behind the sidewalk, the control face of the push button shall be perpendicular to the crosswalk being served (Figure 13-7). If push buttons are mounted in the sidewalk or tree/lawn area, the control face of push buttons shall be perpendicular to the centerline of the street and parallel to the crosswalk being served and shall be mounted so that the control face of the push button is facing the intersection (Figure 13-7).

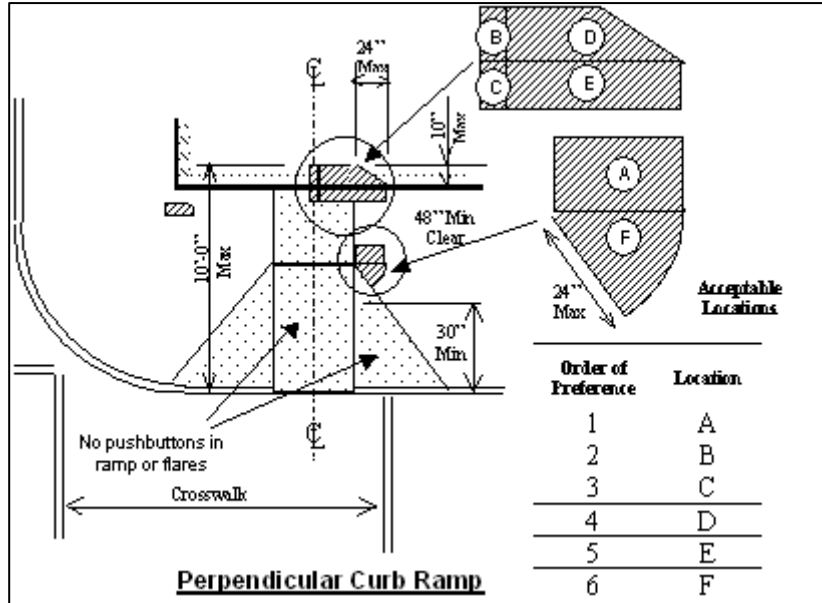

Figure 13-2

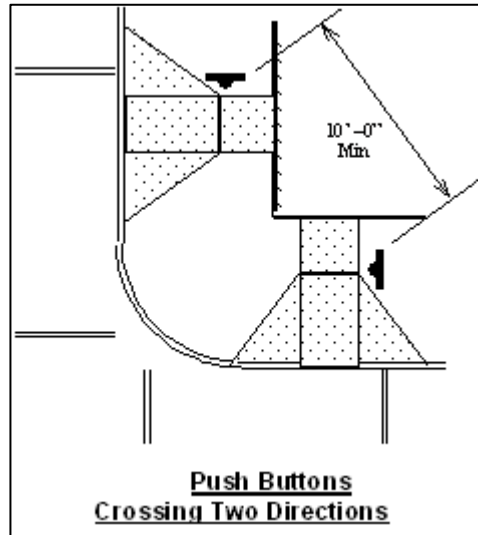

Figure 13-3

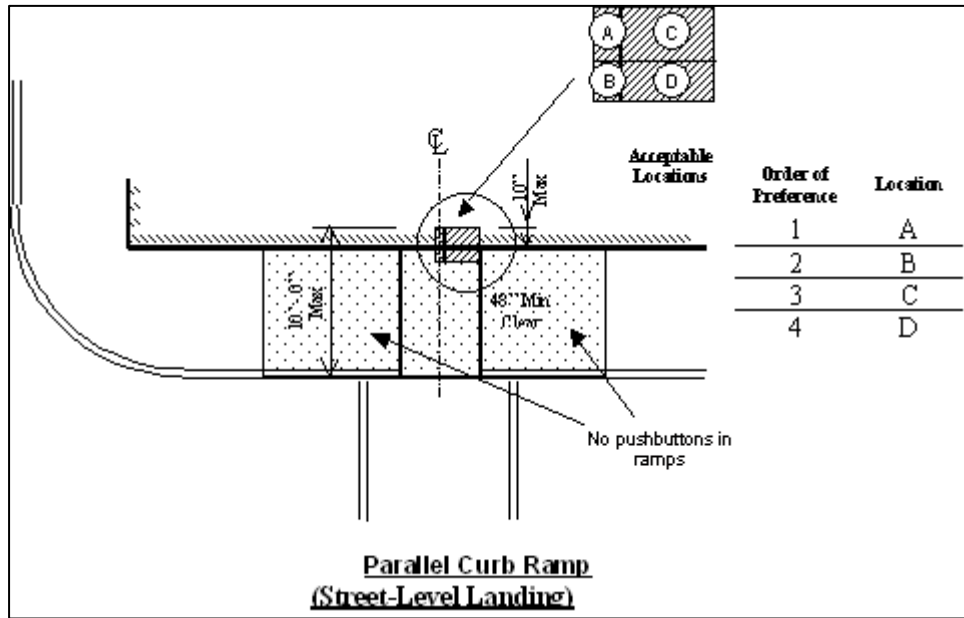

Figure 13-4

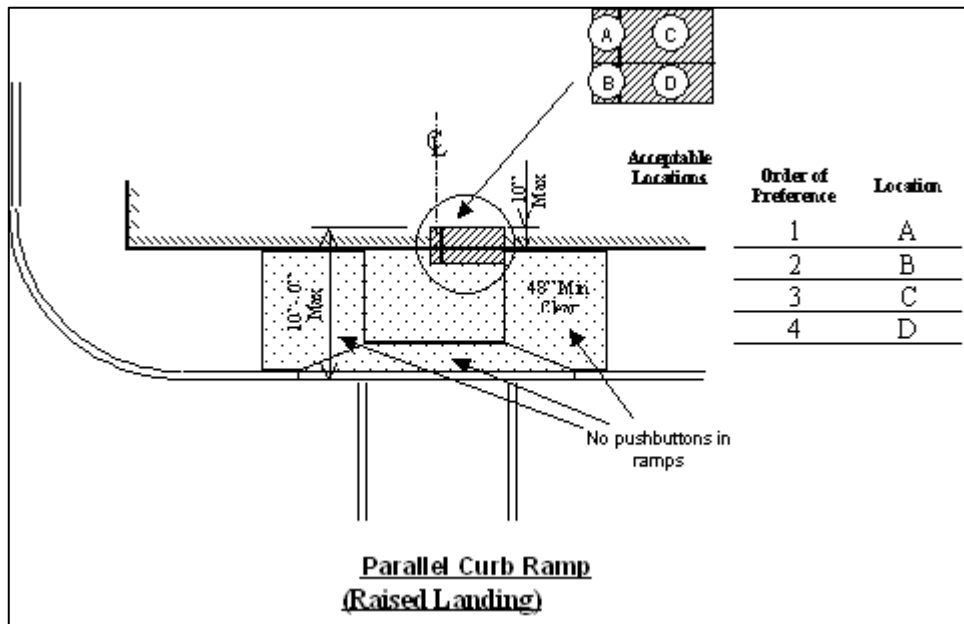

Figure 13-5

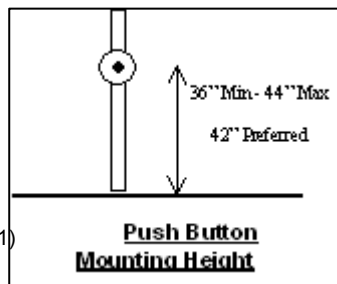

Figure 13-6

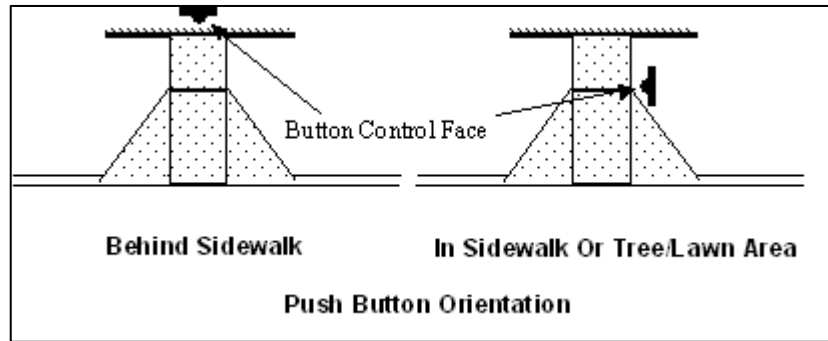

Figure 13-7

C. **Shared-Use Paths**

1. **General.** Shared-use paths shall meet all requirements for an accessible “Pedestrian Access Route” as defined herein, and shall be designed in accordance with AASHTO’s “Guide for the Development of Bicycle Facilities” and City of Columbus requirements.
2. **Landings.** Landings shall be constructed where the running grade of the shared-use path exceeds 5%. For grades up to 8.33% (1:12), landings are required at every 30-inch change in elevation (rise). For steeper grades, consult the Division of Mobility Options ADA Coordinator. Landings may be on either side of the path and may alternate sides. Landings shall be at 5 feet by 5 feet minimum. Approach and departure tapers to each landing are required.
3. **Street Crossings.**
 - a. **Alignment.** Street crossings should be aligned with the shared-use path (see AASHTO for turn radius guidelines).
 - b. **Curb Ramps.** Curb ramps meeting requirements specified elsewhere in this document shall be provided whenever the pathway crosses a curb or the travel paths of bicycles or motor vehicles.
 - c. **Curb Ramp Width.** Curb ramps and transitions shall be as wide as the shared-use path when measured perpendicular to the centerline of the path and a minimum of 4-feet wide when measured perpendicular to the centerline of the wheelchair path.
 - d. **Curb Ramp Flares.** Curb ramp flares shall lay outside of the width of the shared-use path.
 - e. **Lips.** Lips greater than ¼” are not permitted.
 - f. **Detectable Warnings.** Detectable warnings shall be provided in accordance with requirements specified elsewhere in this document. Detectable warnings shall be installed at any and all locations where the base of the ramp and the street are flush.