

# **Columbus City Bulletin**



**Bulletin #44  
November 3, 2018**

# Proceedings of City Council

Saturday, November 3, 2018



## SIGNING OF LEGISLATION

(Note: There was no City Council meeting on *Monday, October 25, 2018*; Subsequently there is no passed or defeated legislation included in this edition.)

### **The City Bulletin Official Publication of the City of Columbus**

Published weekly under authority of the City Charter and direction of the City Clerk. The Office of Publication is the City Clerk's Office, 90 W. Broad Street, Columbus, Ohio 43215, 614-645-7380. The City Bulletin contains the official report of the proceedings of Council. The Bulletin also contains all ordinances and resolutions acted upon by council, civil service notices and announcements of examinations, advertisements for bids and requests for professional services, public notices; and details pertaining to official actions of all city departments. If noted within ordinance text, supplemental and support documents are available upon request to the City Clerk's Office.

# City RFPs, RFQs, and Bids

THE CITY BULLETIN  
BIDS WANTED - PURCHASING OFFICE AND OTHER DIVISIONS

**CITY OF COLUMBUS FORMAL BID OPPORTUNITIES ARE UPDATED DAILY AT:**  
<http://vendors.columbus.gov/sites/public>

Each proposal shall contain the full name and address of every person, firm or corporation interested in the same, and if corporation, the name and address of the President and Secretary.

**EQUAL OPPORTUNITY CLAUSE:** Each responsive bidder shall submit, with its bid, a contract compliance certification number or a completed application for certification. Compliance with the provisions of Article I, Title 39, is a condition of the contract. Failure to comply with this Article may result in cancellation of the contract.

**WITHHOLDING OF INCOME TAX:** All bidders are advised that in order for a contract to bind the City, each contract must contain the provisions found in Section 361.34 C.C.C. with regard to income taxes due or payable to the City of Columbus for wages, salaries and commissions paid to the contractor's employees as well as requiring those contractors to ensure that subcontractors withhold in a like manner.

**LOCAL CREDIT:** In determining the lowest bid for a contract the local bidder credit will not be applied

FOR COPIES OF ANY OF THE FOLLOWING BID PROPOSALS CALL THE LISTED DIVISION

THE CITY BULLETIN  
BIDS WANTED - PURCHASING OFFICE AND OTHER DIVISIONS

BID OPENING DATE - 11/6/2018 1:00:00PM

RFQ010644 - Guardrail and Fence Repair 2018

1.1 Scope: The City of Columbus, Department of Public Service is receiving bids until November 6, 2018 until 1:00 P.M. local time, for construction services for the Roadway Improvements – Guardrail & Fence Repair 2018 project. Bids are to be submitted only at [www.bidexpress.com](http://www.bidexpress.com). Hard copies shall not be accepted.

The work for this project consists: of the restoration and repair of accident-damaged guardrail and fence, replacing deteriorating structures, and installing new structures. The primary function of this contract is to repair accident-damaged guardrail and fence throughout the entire City of Columbus network, and other such work as may be necessary to complete the contract, in accordance with the plans 1846 Drawer A and specifications set forth in the Invitation For Bid (IFB).

A pre-bid meeting will not be held.

Notice of published addenda will be posted on the City's Vendor Services web site and all addenda shall be posted on [www.bidexpress.com](http://www.bidexpress.com).

1.2 Classification: All bid documents (Invitation for Bid, technical specifications, plans, and future addenda) are available for review and download at [www.bidexpress.com](http://www.bidexpress.com). Firms wishing to submit a bid must meet the mandatory requirements stated in the IFB, including being prequalified by the City of Columbus Office of Construction Prequalification. All questions concerning this project are to be sent to [capitalprojects@columbus.gov](mailto:capitalprojects@columbus.gov). The last day to submit questions is October 26,

THE CITY BULLETIN  
BIDS WANTED - PURCHASING OFFICE AND OTHER DIVISIONS

2018; phone calls will not be accepted.

1.3 Bid Express: If you do not have an account with Bid Express and you would like to review projects information or submit a bid, you will need to sign up for an account. Go to [www.bidexpress.com](http://www.bidexpress.com) in order to sign up.

BID OPENING DATE - 11/7/2018 12:00:00PM

RFQ010425 - RWPA HIV Care Support Services

It is the intent of the City of Columbus, Columbus Public Health, to obtain proposals for Ryan White Part A HIV Care support services with funding made available from the U.S. Dept. of Health and Human Services.

Upload your submission at:  
<https://columbus.bonfirehub.com/projects>

Your submission must be uploaded, submitted, and finalized prior to the Closing Time of November 7, 2018 12:00 PM EDT. We strongly recommend that you give yourself sufficient time and at least ONE (1) day before Closing Time to begin the uploading process and to finalize your submission.

You will receive an email confirmation receipt with a unique confirmation number once you finalize your submission.

Minimum system requirements: Internet Explorer 11, Microsoft Edge, Google Chrome, or Mozilla Firefox. Javascript must be enabled. Browser cookies must be enabled.

Need Help?

City of Columbus uses a Bonfire portal for accepting and evaluating proposals digitally. Please contact Bonfire at [Support@GoBonfire.com](mailto:Support@GoBonfire.com) for technical questions related to your submission.

You can also visit their help forum at <https://bonfirehub.zendesk.com/hc>

BID OPENING DATE - 11/7/2018 1:00:00PM

RFQ010584 - Prenatal Trip Assistance

Please see attached. Addendum #1 published 10/19/18. Thank you.

RFQ010707 - RI - Downtown GE 2018

THE CITY BULLETIN  
BIDS WANTED - PURCHASING OFFICE AND OTHER DIVISIONS

The City of Columbus, Department of Public Service is receiving proposals until November 7, 2018 at 1:00 P.M. local time, for professional services for the Roadway Improvements - Downtown GE 2018 RFP. Proposals are being received electronically by the Department of Public Service, Office of Support Services via Bonfire, <https://columbus.bonfirehub.com/login>.

This project involves producing preliminary engineering reports; traffic analyses/studies; preparing exhibits and/or renderings of the landscaping designs and decorative enhancements including but not limited to a part of the improvements proposed to the I70/71 corridors by ODOT; traffic data; safety studies and/or construction plans including but not limited to traffic circulation, parking configuration, land use, bikeway and pedestrian systems; and any updates to an existing VISUM/VISSIM model of the Downtown Area. The selected Consultant will conduct analysis and make recommendations to determine and/or design improvements to the Downtown Area, and other such work as may be necessary to complete the contract, as set forth in this Request for Proposals (RFP). The anticipated budget is \$300,000.

No pre-proposal meeting.

Published addenda will be posted on Bonfire, <https://columbus.bonfirehub.com/login>.

The selected Consultant shall attend a scope meeting to be held on/about November 27, 2018. If the Project Manager is not available, the Consultant may designate an alternate to attend in their place.

All proposal documents (Request for Proposal, addenda, etc.) are available for review and download on Bonfire, <https://columbus.bonfirehub.com/login>. Firms wishing to submit a proposal must meet the mandatory requirements stated in the RFP. All questions concerning the RFP are to be sent to [capitalprojects@columbus.gov](mailto:capitalprojects@columbus.gov). The last day to submit questions is October 30, 2018; no phone calls accepted. Responses will be posted on Bonfire at <https://columbus.bonfirehub.com/login> as an addendum.

RFQ010786 - 51 5101 Sports Trailer

BID OPENING DATE - 11/7/2018 3:00:00PM

RFQ010714 - FEM 1603.2 Electric Power Systems Maintenance Services

The City of Columbus is accepting bids for FEM 1603.2 Electric Power Systems Maintenance Services for DPU Facilities, the work for which consists of electric power distribution systems and it's components that require studies performed, inspection, testing, maintenance, repair and/or replacement with the majority of the work to be on industrial equipment/systems ranging from 120V to 15.5 KV. There may also be inspection, testing, studies performed, maintenance, repair

THE CITY BULLETIN  
BIDS WANTED - PURCHASING OFFICE AND OTHER DIVISIONS

and/or replacement work on > 15.5KV to 138KV equipment/systems that will require a Contractor or Subcontractor to have highly specialized experience in the area of high voltage and other such work as may be necessary to complete the contract, Bids will only be received electronically by the City of Columbus, Department of Public Utilities via Bid Express ([www.bidexpress.com](http://www.bidexpress.com)). Bids are due November 7, 2018 at 3:00 P.M. local time. Bids will be opened electronically and responding bids will immediately be posted to Bid Express as "Apparent Bids." The responding bids will be further reviewed before any contract award is made. No public bid openings will be held pursuant to Columbus City Code Chapter 329.18. The contracting agency will be holding a pre-bid conference. Attendance is strongly recommended. It will be held at 9:00 am on October 31, 2018, at the Southerly Wastewater Treatment Plant, 6977 South High St., Lockbourne, Ohio 43137, Administration Building Conference Room. Following the pre-Bid conference, a tour will be given to allow Bidders to inspect the Project area and facilities. Questions pertaining to the technical specifications must be submitted in writing only to the City's Project Manager Monica Powell, via email at [mopowell@columbus.gov](mailto:mopowell@columbus.gov) prior to Noon on November 1, 2018 local time. Any questions regarding the bidding process may be sent electronically to [DPUConstructionBids@columbus.gov](mailto:DPUConstructionBids@columbus.gov).

BID OPENING DATE - 11/8/2018 9:00:00AM

RFQ010649 - DPU/POWER - CABLE TESTING & PROTECTIVE RELAY SYSTEMS

1.1 SCOPE: It is the intent of the City of Columbus, Division of Power to obtain formal bids to establish a contract for the purchase of one (1) single-phase medium voltage underground cable diagnostics and fault locating test van system ("Cable Testing System") and one (1) multi-phase protective relay test set with hard-sided transit case ("Relay Test Set"). The equipment will be used by the Division of Power to test medium-voltage underground distribution cable and various protective relays, respectively.

1.2 CLASSIFICATION: The contract resulting from this bid proposal will provide for the purchase and delivery of one Cable Testing System and Relay Test Set. Bids shall include one (1) year software support, two (2) years of troubleshooting support, and 40 hours of additional on-site training support (test van only). The awarded bidder will provide parts and warranty for the listed parts. Bidders are required to show experience in providing these types of equipment and warranty service as detail in these specifications.

1.2.1 Bidder Experience: The offeror must submit an outline of its experience and work history in these types of equipment and warranty service for the past five years.

1.2.2 Bidder References: The offeror shall have documented proven successful contracts from at least four customers that the offeror supports that are similar in scope, complexity, and cost to the requirements of this specification.

1.3 Specification Questions: Questions regarding this bid must be submitted on the Vendor Services portal by 11:00 am Monday, October 29, 2018. Responses will be posted on the RFQ on Vendor Services no later than Thursday, November 1, 2018 at 11:00 am.

1.4 For additional information concerning this bid, including procedures on how to submit a proposal, you must go to the City of Columbus Vendor Services web site at <http://vendors.columbus.gov/sites/public> and view this bid number.

THE CITY BULLETIN  
BIDS WANTED - PURCHASING OFFICE AND OTHER DIVISIONS

BID OPENING DATE - 11/8/2018 11:00:00AM

RFQ010438 - Plumbing Maintenance Services UTC

1.0 SCOPE AND CLASSIFICATION:

1.1 Scope: It is the intent of the City of Columbus, Department of Finance and Management, to enter into a Universal Term Contract for the routine maintenance, repair, and/or replacement of plumbing at various City facilities. This contract will extend three (3) years from the execution date.

1.2 Classification: All facilities owned, leased, or, funded by the City of Columbus that may require regular plumbing maintenance and repairs, under Twenty Thousand Dollars (\$20,000) per occurrence. Bidders are required to show experience in providing these types of services, as detailed in these specifications.

1.2.1 Bidder Experience: The plumbing maintenance and repair Bidder must submit an outline of its experience and work history for the past five years, not including any previous service to the City of Columbus.

1.2.1.1 A list of qualified personnel with the requisite experience, and license, if required, must be included in the work history.

1.2.2 Bidder References: Bidder shall have documented proven successful contracts from at least four (4) customers that the Bidder supports that are similar in scope, complexity, and cost to the requirements of this specification. Bidders must hold current Ohio Construction Industry Licensing Board (OCILB) Plumbing license(s).

1.3 Specification Questions: Questions regarding this bid must be submitted on the Vendor Services portal by 1:00 PM Thursday, October 11, 2018. Responses will be posted on the RFQ at Vendor Services website no later than Thursday, October 18, 2018 at 1:00 PM.

1.4 Contract: City of Columbus reserves the right to award multiple contracts from this request.

1.5 For additional information concerning RFQ010438, including procedures on how to submit a proposal, you must go to the City of Columbus Vendor Services web site at <http://vendors.columbus.gov/sites/public> and view this bid case number, RFQ010438.

RFQ010468 - Traffic Signal Strain Poles UTC

1.0. SCOPE AND CLASSIFICATION

1.1 Scope: This proposal is to provide the City of Columbus with a Universal Term Contract to purchase Traffic Signal Strain Pole Equipment, specified herein for use as supports for traffic signals and associated equipment along roadways throughout the City of Columbus. The proposed contract will be in effect through December 31, 2021.

1.2. Classification: The successful bidder will provide and delivery anchor base and embedded traffic signal strain poles in various sizes and with various color finishes. Bidders are required to show experience in providing this type of material and/or warranty service for the past five years.

1.2.1 Bidder Experience: The offeror must submit an outline of its experience and work history in these types of materials and/or warranty service for the past five years.

1.2.2 Bidder References: The offeror shall have documented proven successful



THE CITY BULLETIN  
BIDS WANTED - PURCHASING OFFICE AND OTHER DIVISIONS

contracts from at least four customers that the offeror supports that are similar in scope, complexity, and cost to the requirements of this specification.

1.3 For additional information concerning this bid, including procedures on how to submit a proposal, you must go to the City of Columbus Vendor Services web site at <http://vendors.columbus.gov/sites/public> and view this bid number.

RFQ010601 - DPU/POWER - 72KV OUTDOOR POWER CIRCUIT BREAKER

1.0 SCOPE AND CLASSIFICATION

1.1. SCOPE

It is the intent of the City of Columbus, Department of Public Utilities, Division of Power to obtain bids to establish a contract that will allow for the purchase of outdoor circuit breakers. The circuit breakers shall be furnished complete with all required accessories and components necessary to provide a complete operational unit. The circuit breakers are intended for use in a 72-kV outdoor substation.

1.2. CLASSIFICATION

The contract resulting from this proposal will provide for the purchase and delivery of eight (8) 72-kV, 1,200 AMP, SF6, outdoor substation, three-phase power circuit breaker. A webinar providing for initial drawing approvals is preferred, but another method may be acceptable. State in the "comments" section of the bid how initial drawing will be approved. If no alternative is provided, it will be assumed that a webinar will be provided. Bids are to provide for operating and maintenance manuals and shop drawings. Bids are to provide for testing and final commissioning of breakers once installed.

1.2.1. Bidder Experience

The equipment offeror must submit an outline of its experience and work history in this type of equipment for the past three (3) years.

1.3. ADDITIONAL INFORMATION

For additional information concerning this bid, including procedures on how to submit a proposal, you must go to the City of Columbus Vendor Services web site at <http://vendors.columbus.gov/sites/public> and view this bid number.

RFQ010682 - Crew Trucks

1.0 SCOPE AND CLASSIFICATION

1.1 Scope: It is the intent of the City of Columbus, Department of Public Utilities, Division of Water, to obtain formal bids to establish a contract for the purchase of two (2) single axle crew cab truck with a dedicated compressed natural gas engine and chassis with a minimum G.V.W. rating of 33,000 pounds equipped with a 133 in. maintenance body. The truck will be used by the Water Distribution Maintenance Section.

1.2 Classification: The contract resulting from this bid proposal will provide for the purchase and delivery of two (2) single axle crew cab truck with a dedicated compressed natural gas engine and chassis with a minimum G.V.W. rating of 33,000 pounds equipped with a 133 in. maintenance body. All offerors must document a single axle crew truck certified reseller partnership. Bidders are required to show experience in providing these types of equipment and warranty service as detailed in these specifications. Successful bidder shall provide an authorized facility/company in Franklin County, Ohio or contiguous county to do the warranty work.

THE CITY BULLETIN  
BIDS WANTED - PURCHASING OFFICE AND OTHER DIVISIONS

1.3 Specification Questions: Questions regarding this bid must be submitted on the Vendor Services portal by 11:00 am Thursday, October 25, 2018 at 11:00 am. Responses will be posted on the RFQ on Vendor Services no later than Monday, October 29, 2018 at 11:00 am.

1.4 For additional information concerning this bid, including procedures on how to submit a proposal, you must go to the City of Columbus Vendor Services web site at <http://vendors.columbus.gov/sites/public> and view this bid number.

RFQ010698 - DOT/SECURITY/PCI QSA Services 2018

This is a Request for Proposal for PCIQSA Services 2018 as detailed at <https://columbus.bonfirehub.com/opportunities/11232>

RFQ010709 - DOT/SECURITY/PENETRATION TESTING SERVICES 2018

This RFP including procedures on how to submit a proposal, as detailed at: <https://columbus.bonfirehub.com/opportunities/11249/>

BID OPENING DATE - 11/8/2018 1:00:00PM

RFQ010665 - Intersection Imp-Safety Study GE 2018

1.1 Scope: The City of Columbus, Department of Public Service is receiving proposals until November 8, 2018 at 1:00 P.M. local time, for professional services for the Intersection Improvements - Safety Studies General Engineering 2018 RFP. Proposals are being received electronically by the Department of Public Service, Office of Support Services via Bonfire at <https://columbus.bonfirehub.com/login>.

This project involves developing Safety Studies, School Circulation Studies/Analysis/Plans, and performing Traffic Engineering, Roadway Engineering, Survey/Data Collection, and other such work as may be necessary to complete the contract, as set forth in this Request for Proposals (RFP).

A pre-proposal meeting will not be held.

Published addenda will be posted on Bonfire at <https://columbus.bonfirehub.com/login>.

The selected Consultant shall attend a scope meeting anticipated to be held on/about December

THE CITY BULLETIN  
BIDS WANTED - PURCHASING OFFICE AND OTHER DIVISIONS

06, 2018. If the Project Manager is not available, the Consultant may designate an alternate to attend in their place.

1.2 Classification: All proposal documents (Request for Proposal, reference documents, addenda, etc.) are available for review and download once logged on Bonfire at <https://columbus.bonfirehub.com/login>. Firms wishing to submit a proposal must meet any mandatory requirements stated in the RFP. All questions concerning the RFP are to be sent to [capitalprojects@columbus.gov](mailto:capitalprojects@columbus.gov). The last day to submit questions is October 29, 2018; phone calls will not be accepted. Responses will be posted on Bonfire at <https://columbus.bonfirehub.com/login> as an addendum.

RFQ010702 - Operation Sidewalks-Maple Canyon Ave Sidewalks

1.1 Scope: The City of Columbus, Department of Public Service is receiving proposals until November 8, 2018 at 1:00 P.M. local time, for professional engineering consulting services for the Operation Sidewalks-Maple Canyon Ave Sidewalks RFP. Proposals are being received electronically by Department of Public Service, Office of Support Services. Proposals shall be submitted to <https://columbus.bonfirehub.com/login>.

The Department of Public Service is initiating a procurement effort that will result in the selection of a consultant to perform design services for a project that consists of installing sidewalk along the east side of Maple Canyon Avenue from the existing sidewalk installed at the Fire Station approximately 500 feet north of SR161 to Jewett Drive.

A pre-proposal meeting will not be held.

All questions concerning the RFP are to be sent to [capitalprojects@columbus.gov](mailto:capitalprojects@columbus.gov). The last day to submit questions is October 31, 2018. Responses will be posted as an addendum on the Bonfire website. Phone calls will not be accepted.

The selected Consultants shall attend a scope meeting anticipated to be held on/about December 5, 2018. If the Project Manager is not available, the Consultants may designate an alternate to attend in their place.

1.2 Classification: Firms wishing to submit a proposal must meet the mandatory requirements stated in the RFP.

BID OPENING DATE - 11/9/2018 9:00:00AM

RFQ010782 - Temp Staff Serv for Income Tax

Scope: It is the intent of the City of Columbus, Division of Income Tax to obtain formal bids to establish a twelve (12) month contract for temporary staffing services for, but not limited to, data entry, opening mail, preparing documents to be scanned, and the scanning of documents on a high speed scanner at the Division of Income Tax, as needed, or until the maximum obligation of up to \$100,000.00 is met, whichever comes first.

THE CITY BULLETIN  
BIDS WANTED - PURCHASING OFFICE AND OTHER DIVISIONS

BID OPENING DATE - 11/15/2018 11:00:00AM

RFQ010741 - Special Duty Software solution

1.0 SCOPE AND CLASSIFICATION

1.1 Scope: It is the intent of the City of Columbus, Division/Department of Public Safety to establish a contract for the purchase of an all-in-one turnkey Special Duty Software solution. The Division of Police allows officers to privately contract with companies to provide police-related services. The Division is responsible for the management, recordkeeping, and distribution of police secondary employment, including special duty/off-duty employment (jobs of a police nature). These jobs generally consist of traffic control or security for private entities. Additionally, the Division approves officers' secondary employment (jobs not of a police nature). Officers also self-report both special duty and secondary employment.

The Division currently uses a paper-based system to fill special duty jobs, track outside employment, and bill customers for police equipment use. The Division seeks an electronic-based system to: distribute special duty jobs to personnel; schedule work; invoice equipment payments; and to accurately track compliance with Division rules. By issuing this, the Division believes it can: fill positions more effectively and efficiently; reduce administrative workload; improve communications and customer service; and fully capture invoiced funds.

For additional information concerning this bid, including procedures on how to submit a proposal, you must go to the City of Columbus Vendor Services web site at <http://vendors.columbus.gov/sites/public> and view this bid number.

RFQ010787 - Folding Tables, Chairs and Carts UTC

1.1 Scope: This proposal is to provide the City of Columbus with a Universal Term Contract (blanket type) to purchase folding tables, chairs, and carts to be used by various City agencies. The proposed contract will be in effect through and including March 31, 2021.

1.2 Classification: The successful bidder will provide, deliver and unload fully assembled folding tables, chairs and carts at various City agencies. The cost of delivery shall be included in the stated pricing for each item. Bidders are required to show experience in providing this type of material and/or services as detailed in these specifications.

1.2.1 Bidder Experience: The offeror must submit an outline of its experience and work history in these types of materials and/or warranty service for the past five years.

1.2.2 Bidder References: The offeror shall have documented proven successful contracts from at least four customers that the offeror supports that are similar in scope, complexity, and cost to the requirements of this specification.

1.3 For additional information concerning this bid, including procedures on how to submit a proposal, you must go to the City of Columbus Vendor Services web site at <http://vendors.columbus.gov/sites/public> and view bid number RFQ010787.

BID OPENING DATE - 11/16/2018 11:00:00AM

THE CITY BULLETIN  
BIDS WANTED - PURCHASING OFFICE AND OTHER DIVISIONS

RFQ010505 - Facility Management Services

The City of Columbus invites submission of proposals by qualified businesses to perform facility management services for two (2) properties owned by the City and known as the Jerry Hammond Center (JHC), located at 1111 E. Broad Street, and the Franklin County Municipal Court Building (MCB), located at 375 S. High Street, together, the "Buildings". The Contractor awarded the bid will report directly to the Facilities Management Office of the Department of Finance and Management, located at 90 W. Broad Street, Columbus, Ohio, 43215 in accordance with the terms and conditions set forth in this Request for Proposals ("RFP"). The duties of the Building Manager are to be of a scope and quality generally performed by professional property managers and performed in a reasonable, diligent and careful manner so as to manage and supervise the operation, maintenance and servicing of the Buildings in a manner that is comparable to other "Class A" office properties located in Columbus, Ohio. Detailed descriptions of the buildings are included as Exhibit A - Jerry Hammond Center, and as Exhibit B - Municipal Court Building.

For additional information concerning this bid, including procedures on how to submit a proposal, you must go to the Bonfire portal at <https://columbus.bonfirehub.com/projects/view/10833>

BID OPENING DATE - 11/16/2018 1:00:00PM

RFQ010630 - 650252-100010 JWWTP Screening Improvements

The City of Columbus Division of Sewerage and Drainage is in the planning stages of implementing a Screening Improvements project at Jackson Pike Wastewater Treatment Plant located at 2104 Jackson Pike. Improvements are anticipated to include new screenings presses and related equipment and a new building including HVAC, electrical and other related items. All RFP documents shall be downloaded from Bonfire at <https://columbus.bonfirehub.com/opportunities/11033>. Hard copies will not be provided. Proposals will be received by the City until 1:00 PM Local Time on Friday, November 30, 2018. No proposals will be accepted thereafter. Direct Proposals to: Bonfire <https://columbus.bonfirehub.com/opportunities/11033>.

Questions:

Direct questions via e-mail only to:

Contract Manager, [DPUCapitalRFP@columbus.gov](mailto:DPUCapitalRFP@columbus.gov) No contact is to be made with the City other than with the Contract Manager through e-mail with respect to this proposal or its status. The deadline for questions is November 7, 2018. Answers to questions received will be posted on the City's Vendor Services web site by November 9, 2018.

RFQ010667 - Sustainable Columbus Climate Action Plan

THE CITY BULLETIN  
BIDS WANTED - PURCHASING OFFICE AND OTHER DIVISIONS

The City of Columbus is committed to taking steps to mitigate and adapt to our community's changing climate. Since 2005, the City has been working to reduce its greenhouse gas emissions through environmental policies memorialized in a series of green memos. The City of Columbus is seeking a consultant to develop a Climate Action Plan that is technically feasible and economically reasonable to mitigate GHG emissions. All RFP documents shall be downloaded from <https://columbus.bonfirehub.com/opportunities/11181>. Hard copies will not be provided. Proposals will be received by the City until 1:00PM Local Time on Friday, November 16, 2018. No proposals will be accepted thereafter. Direct questions via e-mail only to: Contract Manager, [DPUCapitalRFP@columbus.gov](mailto:DPUCapitalRFP@columbus.gov) The deadline for questions is October 26, 2018. Answers to questions received will be posted on the Bonfire site at <https://columbus.bonfirehub.com/opportunities/11181> by October 31, 2018.

RFQ010745 - ASR-Hudson St I71 to Cleveland Ave RFP

The City of Columbus, Department of Public Service is receiving proposals until November 16, 2018 at 1:00 P.M. local time, for professional services for the ASR-Hudson St - I71 to Cleveland Ave RFP. Proposals are being received electronically by the Department of Public Service, Office of Support Services via Bonfire at <https://columbus.bonfirehub.com/login>.

This project involves the design of a project along Hudson Street from I-71 to Cleveland Avenue to provide an east-west connection in the Central Ohio Greenways network. The project consists of detailed design for the reconstruction of Hudson Street, and other such work as may be necessary to complete the contract, as set forth in this Request for Proposals (RFP). The reconstructed section will include replacement of the pavement and the creation of an urban greenway. The existing 16", 20" and 2" waterlines will be replaced with a new system. Relocation of private utilities and the Division of Power (DOP) electric distribution system are a possibility and will need to be accounted for in the design. This task order contract will initially be funded with an allocation of \$650,000.

A pre-proposal meeting will not be held.

Published addenda will be posted on Bonfire at <https://columbus.bonfirehub.com/login>.

The selected Consultant shall attend a scope meeting anticipated to be held on/about November 30, 2018. If the Project Manager is not available, the Consultant may designate an alternate to attend in their place.

All proposal documents (Request for Proposal, addenda, etc.) are available for review and download on Bonfire at <https://columbus.bonfirehub.com/login>. Firms wishing to submit a proposal must meet the mandatory requirements stated in the RFP. All questions concerning the RFP are to be sent to [capitalprojects@columbus.gov](mailto:capitalprojects@columbus.gov). The last day to submit questions is November 7, 2018; no phone calls. Responses will be posted on Bonfire at <https://columbus.bonfirehub.com/login> as an addendum.

BID OPENING DATE - 11/16/2018 11:00:00PM

RFQ010110 - RFP - Indigent Burial Services

THE CITY BULLETIN  
BIDS WANTED - PURCHASING OFFICE AND OTHER DIVISIONS

It is the intent of the City of Columbus, Department of Public Safety to obtain proposals to establish an indigent burial services contract for February 1, 2019 through January 31, 2023.

Proposals can be submitted at <https://columbus.bonfirehub.com/projects/view/9930>

BID OPENING DATE - 11/19/2018 11:00:00AM

RFQ010757 - Planning of 2018 Small Business Conference

Planning of 2019 Small Business Conference and Opportunity Exchange.

Learn more and submit your proposal at: <https://columbus.bonfirehub.com/projects/view/11397>

BID OPENING DATE - 11/23/2018 12:00:00PM

RFQ010761 - DOT/DC W/RFSQ PM

<https://columbus.bonfirehub.com/opportunities/11401>

RFQ010773 - DOT/DC W/RFSQ/Cisco Expert Network Engineering Services

<https://columbus.bonfirehub.com/opportunities/11419>

BID OPENING DATE - 11/26/2018 12:00:00PM

RFQ010590 - HIV Prevention Services

THE CITY BULLETIN  
BIDS WANTED - PURCHASING OFFICE AND OTHER DIVISIONS

It is the intent of the City of Columbus, Columbus Public Health, to obtain proposals for HIV Prevention services with funding made available from the Ohio Department of Health.

Upload your submission at:

<https://columbus.bonfirehub.com/projects>

Your submission must be uploaded, submitted, and finalized prior to the Closing Time of November 26, 2018 12:00 PM EDT. We strongly recommend that you give yourself sufficient time and at least ONE (1) day before Closing Time to begin the uploading process and to finalize your submission.

You will receive an email confirmation receipt with a unique confirmation number once you finalize your submission.

Minimum system requirements: Internet Explorer 11, Microsoft Edge, Google Chrome, or Mozilla Firefox. Javascript must be enabled. Browser cookies must be enabled.

Need Help?

City of Columbus uses a Bonfire portal for accepting and evaluating proposals digitally. Please contact Bonfire at [Support@GoBonfire.com](mailto:Support@GoBonfire.com) for technical questions related to your submission.

You can also visit their help forum at <https://bonfirehub.zendesk.com/hc>

BID OPENING DATE - 11/29/2018 11:00:00AM

RFQ010776 - Sanitary Paper UTC

1.0 SCOPE AND CLASSIFICATION

1.1 Scope: This proposal is to provide the City of Columbus with a Universal Term Contract to purchase sanitary paper products, including, toilet paper, paper towels, paper wipes, feminine hygiene products, and dispensers, as needed to be used by various City of Columbus agencies. The proposed contract will be in effect through February 28, 2021.

1.2 Classification: The successful bidder will provide and deliver sanitary paper products. Bidders are asked to quote discounts off price list/catalog pricing. Any variations in a stated discount for size of a purchase, or other factors influencing the final price must be listed in detail. Bidders are required to show experience in providing this type of material as detailed in these specifications.

1.2.1 Bidder Experience: The offeror must submit an outline of its experience and work history in these types of materials and/or warranty service for the past five (5) years.

1.2.2 Bidder References: The offeror shall have documented proven successful contracts from at least four (4) customers that the offeror supports that are similar in scope, complexity, and cost to the requirements of this specification.

1.3 City of Columbus reserves the right to award multiple contracts from this request.

1.4 Specification Questions: Questions regarding this bid must be submitted on the Vendor Services portal by 1:00 PM EST, November 8, 2018. Responses will be posted on the RFQ on Vendor Services no later than November 15, 2018, at 1:00 PM EST.

1.5 For additional information concerning this request, RFQ010776, including procedures on how to submit a proposal, you must go to the City of Columbus Vendor Services web site at <http://vendors.columbus.gov/sites/public> and view this Case ID number, RFQ010776.



THE CITY BULLETIN  
BIDS WANTED - PURCHASING OFFICE AND OTHER DIVISIONS

BID OPENING DATE - 11/29/2018 1:00:00PM

RFQ010700 - STREET EQUIPMENT - REFUSE DATA COLLECTION SYSTEM

1.1 Scope: The City of Columbus, Department of Public Service is receiving proposals until November 29, 2018, at 1:00 P.M. local time, for professional engineering consulting services for the Street Equipment – Refuse Data Collection System RFP. Proposals are being received electronically by Department of Public Service, Office of Support Services. Proposals shall be submitted to <https://columbus.bonfirehub.com/portal/?tab=login>.

The Department of Public Service is initiating a procurement effort for The City of Columbus, Division of Refuse Collection, seeking a refuse data collection system that will gather routing and refuse collection data to allow reporting of collected data for management and efficiency purposes. This project will implement a data collection system to be installed in each refuse truck and to be used with the existing RouteSmart routing system to display routes to be followed by each vehicle.

A pre-proposal meeting will be held on November 5, 2018 from 8:00 A.M. to 3:00 P.M. Local Time, at 2100 Alum Creek Drive, Columbus, Ohio. Attendance is strongly encouraged. See the RFP for instructions as to how to submit questions.

All questions concerning the RFP are to be sent to [capitalprojects@columbus.gov](mailto:capitalprojects@columbus.gov). The last day to submit questions is November 14, 2018. Responses will be posted on Bonfire as an addendum with notification on the Vendor Services portal. Phone calls will not be accepted.

The selected Consultants shall attend a software demonstration anticipated to be held during the month of December, 2018. If the Project Manager is not available, the Consultants may designate an alternate to attend in their place.

1.2 Classification: Firms wishing to submit a proposal must meet the mandatory requirements stated in the RFP.

BID OPENING DATE - 11/30/2018 1:00:00PM

RFQ010668 - Barnett Rd. Stormwater Systems Improvement 611040-100000

This project will investigate existing stormwater drainage issues along Barnett Road between Main Street and Livingston Avenue. The scope of work for this Project is to design approximately: 7,640 linear feet (LF) of new storm sewer to mitigate roadway, yard and ditch flooding issues. Proposals shall be uploaded to the Bonfire website at <https://columbus.bonfirehub.com/opportunities/11380>. Proposals will be received by the City until 1:00 PM Local Time on Friday, November 30, 2018. No proposals will be accepted thereafter. Direct questions via e-mail only to: Contract Manager, [DPUCapitalRFP@columbus.gov](mailto:DPUCapitalRFP@columbus.gov). The deadline for questions is November 9, 2018. Answers to questions received will be posted on the City's Vendor Services web site by November 16, 2018.

THE CITY BULLETIN  
BIDS WANTED - PURCHASING OFFICE AND OTHER DIVISIONS

RFQ010775 - 2018 Sidewalk and Streetlight General Engineering

The Department of Public Utilities is initiating a procurement effort that will result in the award and execution of one engineering contract to a qualified consultant team. The intent of this contract is to provide the Department of Public Utilities, in conjunction with the Department of Public Service and the Department of Neighborhoods, with contractual access to additional resources that are necessary to perform professional engineering and survey services as well as provide technical expertise for the Department to implement sidewalk and streetlight projects for the City's Comprehensive Neighborhood Safety Strategy initiative. Proposals shall be uploaded to the Bonfire website at <https://columbus.bonfirehub.com/opportunities/11418>. Proposals will be received by the City until 1:00PM Local Time on Friday, November 30, 2018. No proposals will be accepted thereafter. No hard copy proposals will be received nor considered.

Direct questions via e-mail only to: Contract Manager, [DPUCapitalRFP@columbus.gov](mailto:DPUCapitalRFP@columbus.gov)

No contact is to be made with the City other than with the Contract Manager through e-mail with respect to this proposal or its status. The deadline for questions is November 16, 2018. Answers to questions received will be posted to the Bonfire web site by November 20, 2018.

# Public Notices

---

The link to the **Columbus City Health Code** pdf shall constitute publication in the City Bulletin of changes to the Columbus City Health Department's Health Code. To go to the Columbus City Health Code, click [here](#) (pdf).

The Columbus City Code's "**Title 7 -- Health Code**" is separate from the Columbus City Health Code. Changes to "Title 7 -- Health Code" are published in the City Bulletin. To go to the Columbus City Code's "Title 7 -- Health Code," click [here](#) (html).

**City of Columbus**  
**City Bulletin Report**

Office of City Clerk  
90 West Broad Street  
Columbus OH 43215-9015  
columbuscitycouncil.org

---

**Legislation Number:** PN0015-2015

**Drafting Date:** 1/27/2015

**Version:** 1

**Current Status:** Clerk's Office for Bulletin

**Matter Type:** Public Notice

**Notice/Advertisement Title:** Published Columbus City Health Code

**Contact Name:** Roger Cloern

**Contact Telephone Number:** 654-6444

**Contact Email Address:** rogerc@columbus.gov

"The Columbus City Health Code is updated and maintained by the Columbus Health Department.

To view the most current City Health Code, please visit:

[www.publichealth.columbus.gov](http://www.publichealth.columbus.gov)

---

**Legislation Number:** PN0089-2018

**Drafting Date:** 5/1/2018

**Version:** 1

**Current Status:** Clerk's Office for Bulletin

**Matter Type:** Public Notice

**Notice/Advertisement Title:** OFFICIAL NOTICE

**Contact Name:** Wendy Brinnon

**Contact Telephone Number:** (614) 645-7531

**Contact Email Address:** wcbriannon@columbus.gov

CIVIL SERVICE COMMISSION

COMPETITIVE EXAMINATION ANNOUNCEMENTS

APPLY ONLINE 24 HOURS A DAY, 7 DAYS A WEEK OR APPLY IN PERSON 9:00 A.M. TO 4:00 P.M. MONDAY THROUGH FRIDAY.

The Civil Service Commission continuously administers competitive examinations. Information regarding examinations, for which the Civil Service Commission is currently accepting applications, is located on our website at

[www.columbus.gov/civilservice](http://www.columbus.gov/civilservice) and is also posted at the Commission offices located at 77 North Front Street, 3rd Floor, Columbus, Ohio, as well as on the 1st Floor in the City Self-Serve Job Center. Please note that all visitors are required to produce a picture ID, authenticating their identity, in order to visit the applications area on the third floor. Applicants interested in City jobs or job announcement alerts should check our website or visit the Commission offices.

---

**Legislation Number:** PN0095-2018

**Drafting Date:** 5/10/2018

**Version:** 1

**Current Status:** Clerk's Office for Bulletin

**Matter Type:** Public Notice

**Notice/Advertisement Title:** German Village Commission 2018 Meeting Schedule - REVISED

**Contact Name:** Connie Torbeck  
**Contact Telephone Number:** (614) 645-0664  
**Contact Email Address:** cltorbeck@columbus.gov

The German Village Commission has its Regular Meeting the 1st Tuesday of every month (barring Holiday exceptions). Copies of the Agenda may be obtained by contacting the above staff.

It is the policy of the City of Columbus that all City-sponsored public meetings and events are accessible to people with disabilities. If you need assistance in participating in this meeting or event due to a disability as defined under the ADA, please call the City's ADA Coordinator at (614) 645-8871 or e-mail zdjones@columbus.gov at least three (3) business days prior to the scheduled meeting or event to request an accommodation

| Application Deadline<br>(111 N. Front St.<br>@BZS Counter) | Business Meeting Dates<br>(111 N. Front St 3rd Fl. Rm #312)<br>12:00pm | Regular Meeting Date<br>111 N. Front St., Hearing Rm #204<br>4:00pm |
|--|--|---|
| May 22, 2018   | May 29, 2018   | June 5, 2018  |
| June 19, 2018  | June 26, 2018  | Thurs., July 5, 2018*   |
| July 24, 2018  | July 31, 2018  | August 7, 2018  |
| August 21, 2018  | August 28, 2018  | Wed., September 5, 2018*  |
| September 18, 2018   | September 25, 2018   | October 2, 2018   |
| October 23, 2018   | October 30, 2018   | Wed., November 7, 2018*   |
| November 20, 2018  | November 27, 2018  | December 4, 2018  |
| December 18, 2019  | Thurs., December 27, 2018*   | *Wednesday, January 2, 2019*  |

NOTE:  
**\*Date change due to Holiday**

**Legislation Number:** PN0096-2018

**Drafting Date:** 5/10/2018

**Version:** 1

**Current Status:** Clerk's Office for Bulletin

**Matter Type:** Public Notice

**Notice/Advertisement Title:** Brewery District Commission 2018 Meeting Schedule - REVISED

**Contact Name:** Cristin Moody  
**Contact Telephone Number:** (614) 645-8040  
**Contact Email Address:** camoody@columbus.gov

The Brewery District Commission has its Regular Meeting the 1st Thursday of every month (barring Holiday exceptions). Copies of the Agenda may be obtained by contacting the above staff.

It is the policy of the City of Columbus that all City-sponsored public meetings and events are accessible to people with disabilities. If you need assistance in participating in this meeting or event due to a disability as defined under the ADA, please call the City's ADA Coordinator at (614) 645-8871 or e-mail zdjones@columbus.gov at least three (3) business days prior to the scheduled meeting or event to request an accommodation.

| Application Deadline<br>(111 N. Front St.<br>@BZS Counter) | Business Meeting Date<br>(111 N. Front St. Rm #312)<br>12:00p.m. | Hearing Date<br>(111 N. Front St. Hearing Rm. #204)<br>6:00p.m. |
|--|--|---|
| May 24, 2018   | May 31, 2018   | June 7, 2018  |
| June 21, 2018  | June 28, 2018  | <b>July 5, 2018 (Rm. #205)</b>                                  |
| July 19, 2018  | July 26, 2018     August 2, 2018                                 |   |
| August 23, 2018  | August 30, 2018  | September 6, 2018   |
| September 20, 2018   | September 27, 2018   | October 4, 2018   |
| October 18, 2018   | October 25, 2018   | November 1, 2018  |
| November 21, 2018*   |  |   |
| <b>(drop off by 12:00 pm)</b>                              | November 29, 2018  | December 6, 2018  |
| December 20, 2018  | December 27, 2018  | January 3, 2019   |

\* Date change due to Holiday

**Legislation Number:** PN0098-2018

**Drafting Date:** 5/10/2018

**Version:** 1

**Current Status:** Clerk's Office for Bulletin

**Matter Type:** Public Notice

**Notice/Advertisement Title:** Italian Village Commission 2018 Meeting Schedule - REVISED

**Contact Name:** James Goodman

**Contact Telephone Number:** (614) 645-7920

**Contact Email Address:** jagoodman@columbus.gov

The Italian Village Commission has its Regular Meeting the 3rd Tuesday of every month (barring Holiday exceptions). Copies of the Agenda may be obtained by contacting the above staff.

It is the policy of the City of Columbus that all City-sponsored public meetings and events are accessible to people with disabilities. If you need assistance in participating in this meeting or event due to a disability as defined under the ADA, please call the City's ADA Coordinator at (614) 645-8871 or e-mail zdjones@columbus.gov at least three (3) business days prior to the scheduled meeting or event to request an accommodation.

| Application Deadline<br>(111 N. Front St.<br>@BZS Counter) | Business Meeting Date<br>(111 N. Front St. Rm 312)<br>12:00p.m. | Hearing Date<br>(111 N. Front St. Hearing Rm. 204)<br>6:00p.m. |
|--|---|--|
| April 3, 2018  | April 10, 2018  | April 17, 2018   |
| May 1, 2018  | May 8, 2018   | May 15, 2018   |
| June 5, 2018   | June 12, 2018   | June 19, 2018  |
| July 3, 2018   | July 10, 2018   | July 17, 2018  |
| August 7, 2018   | August 14, 2018   | August 21, 2018  |

|                   |                    |                     |
|-------------------|--------------------|---------------------|
| September 4, 2018 | September 11, 2018 | September 18, 2018  |
| October 2, 2018   | October 9, 2018    | October 16, 2018    |
| November 6, 2018  | November 13, 2018  | November 20, 2018   |
| December 4, 2018  | December 11, 2018  | December 18, 2018 * |
| January 2, 2019*  | January 8, 2019    | January 15, 2019    |

\*Room location subject to change. Contact staff member

**Legislation Number:** PN0099-2018

**Drafting Date:** 5/10/2018

**Version:** 1

**Current Status:** Clerk's Office for Bulletin

**Matter Type:** Public Notice

**Notice/Advertisement Title:** Historic Resource Commission 2018 Meeting Schedule - REVISED

**Contact Name:** Connie Torbeck

**Contact Telephone Number:** (614) 645-0664

**Contact Email Address:** cltorbeck@columbus.gov

The Historic Resource Commission has its Regular Meeting the 3rd Thursday of every month (barring Holiday exceptions). Copies of the Agenda may be obtained by contacting the above staff.

It is the policy of the City of Columbus that all City-sponsored public meetings and events are accessible to people with disabilities. If you need assistance in participating in this meeting or event due to a disability as defined under the ADA, please call the City's ADA Coordinator at (614) 645-8871 or e-mail zdjones@columbus.gov at least three (3) business days prior to the scheduled meeting or event to request an accommodation.

| Application Deadline<br>(111 N. Front St.)<br>@BZS Counter) | Business Meeting Date<br>(111 N. Front St., Rm 312)<br>12:00p.m. | Hearing Date<br>(111 N. Front St. Hearing room HRm. 204)<br>6:00p.m. |
|---|--|--|
| May 3, 2018   | May 10, 2018   | May 17, 2018   |
| June 7, 2018  | June 14, 2018  | June 21, 2018  |
| July 5, 2018  | July 12, 2018 July 19, 2018                                      |  |
| August 2, 2018  | August 9, 2018   | August 16, 2018  |
| September 6, 2018   | September 13, 2018   | September 20, 2018   |
| October 4, 2018   | October 11, 2018   | October 18, 2018   |
| November 1, 2018  | November 8, 2018   | November 15, 2018  |
| December 6, 2018  | December 13, 2018  | December 20, 2018  |

**Legislation Number:** PN0100-2018

**Drafting Date:** 5/10/2018

**Version:** 1

**Current Status:** Clerk's Office for Bulletin

**Matter Type:** Public Notice

**Notice/Advertisement Title:** East Franklinton Review Board 2018 Meeting Schedule - REVISED

**Contact Name:** Dan Ferdelman  
**Contact Telephone Number:** (614) 645-6096  
**Contact Email Address:** dbferdelman@columbus.gov

Meeting Accommodations: It is the policy of the City of Columbus that all City-sponsored public meetings and events are accessible to people with disabilities. If you need assistance in participating in this meeting or event due to a disability as defined under the ADA, please call the City's ADA Coordinator at (614) 645-8871 or e-mail zdjones@columbus.gov at least three (3) business days prior to the scheduled meeting or event to request an accommodation.

|  |  |
|--|--|
| Application Deadline<br>(111 N. Front St.<br>@BZS Counter) | Regular Meeting*<br>(111 N. Front St.<br>Rm. #203)<br>3:00pm |
|--|--|

|                   |                    |
|-------------------|--------------------|
| May 1, 2018       | May 15, 2018       |
| June 5, 2018      | June 19, 2018      |
| July 3, 2018**    | July 17, 2018      |
| August 7, 2018    | August 21, 2018    |
| September 4, 2018 | September 18, 2018 |
| October 2, 2018   | October 16, 2018   |
| November 6, 2018  | November 20, 2018  |
| December 4, 2018  | December 18, 2018  |

\*Meetings subject to cancellation. Please contact staff to confirm.

\*\*Drop-off by Noon due to office closures for Holiday

Applications should be submitted by 5:00pm on deadline day.

---

**Legislation Number:** PN0101-2018

**Drafting Date:** 5/10/2018

**Version:** 1

**Current Status:** Clerk's Office for Bulletin

**Matter Type:** Public Notice

**Notice/Advertisement Title:** Downtown Commission 2018 Meeting Schedule - REVISED

**Contact Name:** Daniel Thomas

**Contact Telephone Number:** 614-645-8404

**Contact Email Address:** djthomas@columbus.gov

**DROP OFF:**

111 N. Front St., @BZS Counter

Regular Meeting  
111 N. Front St.  
Hearing Room #204



8:30am - 11:00am

May 22, 2018  
June 26, 2018  
July 24, 2018  
August 28, 2018  
September 25, 2018  
October 23, 2018  
November 20, 2018  
December 18, 2018

Meeting Accommodations: It is the policy of the City of Columbus that all City-sponsored public meetings and events are accessible to people with disabilities. If you need assistance in participating in this meeting or event due to a disability as defined under the ADA, please call the City's ADA Coordinator at (614) 645-8871 or e-mail [zdjones@columbus.gov](mailto:zdjones@columbus.gov) at least three (3) business days prior to the scheduled meeting or event to request an accommodation.

---

**Legislation Number:** PN0102-2018

**Drafting Date:** 5/10/2018

**Version:** 1

**Current Status:** Clerk's Office for Bulletin

**Matter** Public Notice

**Type:**

**Notice/Advertisement Title:** Land Review Commission 2018 Schedule -REVISED

**Contact Name:** Kevin Wheeler

**Contact Telephone Number:** 614-645-6057

**Contact Email Address:** [kjwheeler@columbus.gov](mailto:kjwheeler@columbus.gov)

The following scheduled Land Review Commission meetings are subject to cancellation. Please contact staff member to confirm.

111 N. Front St.  
Room # 312  
9:00am

May 17, 2018  
June 21, 2018  
July 19, 2018  
August 16, 2018  
September 20, 2018  
October 18, 2018  
November 15, 2018  
December 20, 2018

Meeting Accommodations: It is the policy of the City of Columbus that all City-sponsored public meetings and events are accessible to people with disabilities. If you need assistance in participating in this meeting or event due to a disability as defined under the ADA, please call the City's ADA Coordinator at (614) 645-8871 or e-mail

zdjones@columbus.gov at least three (3) business days prior to the scheduled meeting or event to request an accommodation

---

**Legislation Number:** PN0103-2018

**Drafting Date:** 5/10/2018

**Current Status:** Clerk's Office for Bulletin

**Version:** 1

**Matter Type:** Public Notice

**Notice/Advertisement Title:** Columbus Art Commission 2018 Meeting Schedule - REVISED

**Contact Name:** Lori Baudro

**Contact Telephone Number:** (614) 645-6986

**Contact Email Address:** lsbaudro@columbus.gov

Meeting Accommodations: It is the policy of the City of Columbus that all City-sponsored public meetings and events are accessible to people with disabilities. If you need assistance in participating in this meeting or event due to a disability as defined under the ADA, please call the City's ADA Coordinator at (614) 645-8871 or e-mail zdjones@columbus.gov at least three (3) business days prior to the scheduled meeting or event to request an accommodation.

| Application Deadline             | Hearing Dates                       |
|----------------------------------|-------------------------------------|
| 111 N. Front St<br>@BZS Counter) | 111 N. Front St., Rm. 203<br>5:00pm |

|                   |                    |
|-------------------|--------------------|
| May 4, 2018       | May 22, 2018       |
| June 1, 2018      | June 26, 2018      |
| July 6, 2018      | July 24, 2018      |
|                   | No August Meeting  |
| September 7, 2018 | September 25, 2018 |
| October 5, 2018   | October 23, 2018   |
| November 2, 2018  | November 27, 2018  |
| December 7, 2018  | December 18, 2018* |

\*Room is subject to change

---

**Legislation Number:** PN0106-2018

**Drafting Date:** 5/18/2018

**Current Status:** Clerk's Office for Bulletin

**Version:** 1

**Matter Type:** Public Notice

**Notice/Advertisement Title:** Westland Area Commission By-Laws

**Contact Name:** David Hooie

**Contact Telephone Number:** (614) 645-7343

**Contact Email Address:** dehooie@columbus.gov

see attachment

---

**Legislation Number:** PN0119-2018

**Drafting Date:** 6/4/2018

**Current Status:** Clerk's Office for Bulletin

**Version:** 1

**Matter** Public Notice

**Type:**

**Notice/Advertisement Title:** University Impact District Review Board 2018 Meeting Schedule - **REVISED**

**Contact Name:** Daniel Ferdelman, AIA

**Contact Telephone Number:** 614-645-6096 Fax: 614-645-6675

**Contact Email Address:** dbferdelman@columbus.gov

Date of Submittal  
(111 N. Front St.  
@ BZS Counter)

Date of Meeting  
111 N. Front St., Hearing Rm #204  
4:00pm

June 14, 2018

June 28, 2018

July 12, 2018

July 26, 2018

August 9, 2018

August 23, 2018

September 13, 2018

September 27, 2018

October 11, 2018

October 25 2018

November 1, 2018

November 15, 2018\*

December 6, 2018

December 20, 2018\*

Meeting Accommodations: It is the policy of the City of Columbus that all City-sponsored public meetings and events are accessible to people with disabilities. If you need assistance in participating in this meeting or event due to a disability as defined under the ADA, please call the City's ADA Coordinator at (614) 645-8871 or e-mail [zdjones@columbus.gov](mailto:zdjones@columbus.gov) at least three (3) business days prior to the scheduled meeting or event to request an accommodation.

\*Dates changed due to Holidays

Meetings held in Rm #205.

---

**Legislation Number:** PN0155-2018

**Drafting Date:** 7/10/2018

**Current Status:** Clerk's Office for Bulletin

**Version:** 1

**Matter** Public Notice

**Type:**

**Notice/Advertisement Title:** Victorian Village Commission 2018 Meeting Schedule - REVISED

**Contact Name:** Cristin Moody

**Contact Telephone Number:** (614) 645-8040

**Contact Email Address:** [camoody@columbus.gov](mailto:camoody@columbus.gov)

The Victorian Village Commission has its Regular Meeting the 2nd Wednesday of every month (barring Holiday exceptions).

Copies of the Agenda may be obtained by contacting the above staff.

It is the policy of the City of Columbus that all City-sponsored public meetings and events are accessible to people with disabilities. If you need assistance in participating in this meeting or event due to a disability as defined under the ADA, please call the City's ADA Coordinator at (614) 645-8871 or e-mail [zdjones@columbus.gov](mailto:zdjones@columbus.gov) at least three (3) business days prior to the scheduled meeting or event to request an accommodation.

| Application Deadline<br>(111 N. Front St<br>@BZS Counter) | Business Meeting Date<br>(111 N. Front St., Rm. #312)<br>12:00p.m. | Hearing Date<br>(111 N. Front St., Hearing Rm 204)<br>6:00p.m. |
|---|--|--|
| July 26, 2018   | August 2, 2018   | July 11, 2018  |
| August 30, 2018   | September 6, 2018  | August 8 2018  |
| September 27, 2018  | October 4, 2018  | September 12, 2018   |
| October 25, 2018  | November 1, 2018   | October 10, 2018   |
| November 29, 2018   | December 6, 2018   | November 14, 2018  |
| December 27, 2018   | January 3, 2019  | December 12, 2018  |
|   |  | January 9, 2019  |

---

**Legislation Number:** PN0170-2018

**Drafting Date:** 7/30/2018

**Version:** 1

**Current Status:** Clerk's Office for Bulletin

**Matter** Public Notice

**Type:**

**Notice/Advertisement Title:** Columbus Recreation and Parks 2018 Updated Commission Meetings

**Contact Name:** Stephanie Brock

**Contact Telephone Number:** 614-645-5932

**Contact Email Address:** [sybrock@columbus.gov](mailto:sybrock@columbus.gov)

**Columbus Recreation and Parks  
2018 Updated Commission Meetings**

***NOTICE OF REGULAR MEETINGS***

***COLUMBUS RECREATION AND PARKS COMMISSION***

The Recreation and Parks Commission, appointed and organized under the Charter of the City of Columbus, Section 112-1 is empowered to equip, operate, direct and maintain all the existing recreational and park facilities. In addition, said Commission exercises certain powers and duties as specified in Sections 112-1 and 112-2 of the Columbus City Charter.

Please take notice that meetings of the Recreation and Parks Commission will be held at 8:30a.m. on the following dates and locations (unless otherwise posted):

***Wednesday, January 10, 2018 - 1111 East Broad Street, 43205***

*Wednesday, February 14, 2018 - Sullivant Gardens Center, 755 Renick St., 43223*  
*Wednesday, March 14, 2018 - 1111 East Broad Street, 43205*  
*Wednesday, April 11, 2018 - Holton Community Center, 303 N. Eureka Ave., 43204*  
*Wednesday, May 9, 2018 - 1111 East Broad Street, 43205*  
*Wednesday, June 13, 2018 - 1111 East Broad Street, 43205*  
*Wednesday, July 11, 2018 - Mentel Golf Course, 6005 Alkire Rd., 43119*  
*August Recess - No Meeting*  
*Wednesday, September 12, 2018 - Westgate Community Center, 455 S. Westgate Ave., 43204*  
*Wednesday, October 10, 2018 - 1111 East Broad Street, 43205*  
*Wednesday, November 14, 2018 - CPAC, 549 Franklin Ave., 43215*  
*Wednesday, December 12, 2018 - 1111 East Broad Street, 43205*

In the event no proper business exists the meeting may be cancelled without further notice. For further information you may contact the Columbus Recreation and Parks Department, 1111 East Broad Street, Suite 200, Columbus, Ohio 43205 (Telephone: 614-645-3319).

Tony A. Collins, Director  
Columbus Recreation and Parks Department

---

**Legislation Number:** PN0193-2018

**Drafting Date:** 8/27/2018

**Version:** 1

**Current Status:** Clerk's Office for Bulletin

**Matter:** Public Notice

**Type:**

**Notice/Advertisement Title:** Southwest Area Commission Bylaws Revised

**Contact Name:** Beth Fairman Kinney

**Contact Telephone Number:** (614) 645-5220

**Contact Email Address:** bkinney@columbus.gov

Southwest Area  
Commission Bylaws  
Revised

These Bylaws establish the procedure under which the Southwest Area Commission shall execute those duties and functions set forth in and with authority granted under Chapters 3109 and 3111 of the Columbus City Codes (herein abbreviated as C.C.).

Article I. Name

The name of this organization shall be the Southwest Area Commission, herein referred to as the "Commission".

Article II. Area

The boundaries of the Commission are: to the north, Mound Street, Mt. Calvary and Greenlawn Avenues, to the east by the Scioto River, to the south by Interstate 270 and to the west by CSX Railroad tracks, or as detailed in C.C. 3111. The Commission serves the incorporated areas of the City of Columbus, and strives to maintain an effective working relationship with the jurisdictions that fall within the Commission's boundaries which include: Franklin County, Franklin Township, Urbancrest and Jackson Township.

#### Article III. Purpose

1. The purpose of this Commission shall be to afford additional voluntary citizen participation in decision making in an advisory capacity to the City Administration and City Council and to facilitate communication, understanding, and cooperation between neighborhood groups, city officials, and developers. The Commission shall:

A. In the interests of local planning for local needs, identify and study problems and requirements of the Commission Area in order to:

1. Create plans and policies, which will serve as guidelines for future development of the Area;
2. Bring the problems and needs of the Area to the attention of appropriate government agencies or residents; and
3. Recommend solutions or legislation.

B. Air and promote communication within the Commission Area and between it and the rest of the City by means of:

1. Regular and special meetings of the Commission which are open to the public;
2. Public hearings on problems, issues or proposals affecting the area;
3. Public forums and surveys to provide an opportunity for Area residents, businesses and organizations to state their problems and concerns.
4. Soliciting active cooperation of all segments of the Area and City, including organizations, institutions, and government.
5. Initiating proposals and supporting those introduced by individual citizens or area organizations, which will enhance the quality of life enjoyed by area residents and preserve the unique residential and commercial mix of the Area; and
6. Promoting and encouraging businesses whose functions, methods of operation, architectural appearance, and locations are consistent with the character and requirement of the Area.

C. Initiate, review, and recommend criteria and programs for the preservation, development and enhancement of the Commission Area, including, but not limited to, parks, recreation areas, sidewalks, street, and traffic, by means of:

1. Reviewing the proposed Capital Improvements Budget and proposing new items and changes relating to the Area;
2. Making recommendations for restoration and preservation of the historical elements within the Area; and
3. Receiving and reviewing for recommendation, prior to the adoption by governmental bodies, any new or revised comprehensive plan affecting the Area.

D. Recommend priorities for and review government services and operation of the various government departments in the Commission Area by means of:

1. Requesting and receiving from departments or agencies periodic reports concerning governmental services or practices in the Area;
2. Meeting with administrative heads of any department or agency, or any of their subordinates, to obtain additional information deemed necessary for the Commission to fulfill its functions.
3. Requesting and receiving from departments or agencies, prior to implementation, full reports on any proposed changes in service or practice in the Area, and recommending approval or disapproval of the proposed changes;
4. Reviewing and evaluating pending legislation substantially affecting the Area prior to its consideration by Council; and

5. Review and comment on zoning issues and demolitions presented to the Commission.

E. Recommend persons from the Commission Area for nomination to membership on City boards and commissions, which make decisions or recommendations affecting the Commission Area.

2. The Commission shall not endorse any candidate for public office.

Article  
IV.  
Membe  
rship

1. Appointment. All Commissioners shall be appointed by the Mayor of the City of Columbus in accordance with C.C. 3109. The Secretary shall notify the Mayor of all nominations, elections, and vacancies within ten days of such action.

A. Should the Mayor neither approve nor disapprove the action within thirty (30) days of notifications, the action shall be deemed approval until notice from the Mayor as specified in C.C.3109.

B. A copy of each notice shall be sent to the City Council in care of the City Clerk.

2. Members. The Commission shall consist of up to thirteen (13) members. Each member shall either reside, work or own property in the Commission Area and serve without compensation.

A. Nine (9) Elected Commissioners shall be selected from the Southwest Area. The nine (9) Commissioners shall be selected in accordance with the selection rules adopted by the Southwest Area Commission. Each elected Commissioner must be a resident in the City of Columbus.

B. Four (4) At-Large Commissioners, should either be employed, own real property or operate a business within the Area, shall be nominated by the Commission. The four (4) individuals nominated by the Commission may be from, but not limited to, the following: one (1) official from South-Western City Schools; one (1) from the fields of human services; one (1) representative of the Southwest Area clergy; and one (1) from the Southwest Area Business Association.

C. The Commission must maintain a majority of the members to be residents of the Southwest Area boundaries.

3. Terms. The term of membership of elected officials shall be three (3) years. All terms shall expire during the annual meeting in the year that the term expires; however, a member may continue to serve beyond term expiration until a successor is appointed. Terms shall be staggered so as to maintain continuity of experienced representation. As determined by lot, one-third of the initial membership shall serve for one (1) year; one third, for two (2) years; and the remaining one-third, for three (3) years or until their successors are appointed. Term of at-large commissioners shall be for three (3) years.

4. No Commission member shall represent the Commission in its official actions before any other public body or official, except as specifically authorized in writing by the Commission. This shall not be construed as a restriction upon the right of the individual members to represent their own views before public or private bodies, whether in agreement or disagreement with the official action of the Commission.

1. 5. Disqualification. Members shall maintain their residence, property or business in the Commission Area from which they were elected or appointed. Failure of a member to maintain his or her residence, property or business in the Southwest Commission Area, shall be deemed a resignation and the Secretary shall notify the Mayor, City Clerk and the Director of Development.

6. Attendance. The year starts with the annual meeting in September. Members shall, so far as possible, be regular in attendance. A member's absence from four (4) regular meetings in any one (1) year, shall be deemed a resignation from the Commission, unless a petition has been received by the Chairperson of the Commission. The Commission must act upon the petition after it is received at either the next regularly scheduled meeting or the following regularly scheduled meeting. The petition must be made in writing and received by the Chairperson at least eight (8) days prior to the next regular meeting following the fourth absence. The petition is to request that some or all of the absences

be excused due to extenuating circumstances. The nature of the extenuating circumstances shall be explained. If the Commission accepts, by majority vote, all or portion of the absences may be excused. If a petition is not received, it shall be deemed a resignation from the Commission and notice of such will be communicated to the City of Columbus. After the third missed meeting, the secretary will remind the member of the attendance policy. After the fourth missed meeting, the secretary will remind the member about the need to submit a petition to the Chairperson if the member would like to maintain their position. Members shall, so far as possible, inform either the Chairperson or the Secretary, prior to the meeting, when they know they will be absent.

7. The Commission shall nominate one or more candidates to fill any vacancy caused by death, disqualification, or other means for the remainder of the unexpired term by letter to the Mayor pursuant to C.C. 3109. When there is a vacancy, public notice will be made on the web site and/or emailed to the community member email list.

Arti  
cle  
V.  
Offi  
cers

1. The officers of the Commission shall be: Chairperson, Vice-Chairperson, Secretary and Fiscal Officer. At the first meeting of the Commission, officers shall be elected by majority vote of the members. Thereafter, election of officers shall be at the annual meeting. Officers shall serve one (1) year, or until a successor is elected. There is no limit to the number of terms that someone can serve in the same office. Each officer shall have the right to vote on any question

2. The Chairperson shall preside at all meetings of the Commission; in consultation with other Commission members, appoint standing and special committees of the Commission; serve as an ex-officio member of all committees; coordinate the actions of officers and committee chairperson; and perform other duties associated with the office as required.

3. The Vice-Chairperson shall assist the Chairperson; perform all the duties of the Chairperson in his or her absence; and perform other such duties as may be assigned by the Commission.

4. The Secretary shall call and record roll; remind a member of his or her absences per Article IV, section 6; record and maintain accurate voting records and meeting summaries which shall be open to public examination; maintain such other records as the Commission may direct; notify the Mayor of any vacancy; perform related duties as may be assigned by the Commission; and in the absence of both the Chairperson and the Vice-Chairperson, call the meeting to order and preside until the immediate election of a chairperson pro tempore.

5. The Fiscal Officer shall receive all funds and disburse all funds with the Commission's approval.

6. A vacancy in the office of the Chairperson shall be filled by the Vice-Chairperson. A vacancy in any other position shall be filled in the same manner as the original selection.

Arti  
cle  
VI.  
Mee  
ting

1. Regular meetings will be held quarterly in August, November, February and May on the third Wednesday of the month at 7:00 pm. Meetings will be held in January, March, April, June, July, September, October and December on the third

1. Wednesday of the month at 7:00 pm if an application for zoning, graphics or special permit has been received



and the applicant requests time on the agenda at least ten days prior to the third Wednesday of the month. Meetings will occur in this manner unless otherwise directed by the majority vote of the Commission in sufficient time to notify constituents and the City Administration of such change. Each meeting shall be held in the Commission Area unless suitable facilities are not available in which they may seek suitable facilities contiguous to the Commission Area in an appropriate, large room convenient for members and the public chosen by the Commission as its regular meeting place, unless otherwise specified at least fifteen (15) days prior to the meeting. Notice of the meeting with an agenda shall be published in the City Bulletin prior to changing meeting time or location.

2. The annual meeting shall be the first regular meeting in September at which time new members will be seated and new officers elected.

3. Special meetings may be called by Executive Committee, the Chairperson, or by majority of the members in a regular or special meeting. The meeting's purpose, date, time, and location shall be stated when the meeting is called. No business will be considered at a special meeting unless it was stated when the meeting was called. Except in cases of emergency, three (3) days notice shall be given for a special meeting.

4. All meetings shall be open to the public, and notice shall be published, when possible, at least seven (7) days in advance in a newspaper of general circulation in the Commission Area and on the web site and/or community member email list.

5. Quorum: A majority of the total membership shall constitute a quorum for conducting business.

6. Voting: A majority of the Commission members present and voting shall be required to approve any action. A tie vote is disapproval. The Chairperson shall state each issue in a positive form such as "The question before the Commission is: Shall the application (request approval) be approved?"

7. The Order of Business can be determined by the Chair. A suggested format is:

1. Pledge of Allegiance
2. Roll Call
3. Zoning
4. Invited Guests
5. Routine Business
6. New Business
  - A. Reports
  - B. Announcements
7. Old Business
8. Adjournment

8. The Chairperson shall recognize members of the public who wish to address the Commission concerning issues under discussion. The Chairperson shall uniformly limit debate to an equal amount of time for each side of the issue. Time limits may be set by the Commission. When appropriate, further action on the issue may be deferred to the next Commission meeting.

9. Dissenting or non-concurring reports may be filed with the Secretary by any Commission member and shall be attached to the majority report.

10. Individual citizens or Commissioners may be asked to research a specific topic and report findings to the Commission.

#### Article VII. Committees

1. The Chairperson shall appoint Commission members to standing committees giving due consideration to their individual preferences and subject to approval by a majority vote of the Commission members.

2. The Chairperson shall appoint non-members to Commission committees from recommendations by Commission members appointed to that particular committee subject to approval by a majority vote of the Commission members. Non-member appointees shall have full voting privileges in all proceedings of the committee to which they are appointed. The number of non-members on any committee shall not exceed the number of Commission members appointed.
3. Committee members shall serve at the pleasure of the Chairperson and their appointments shall expire at the next annual meeting.
4. The Chairperson shall be an ex-officio member of all committees, except the Nominating Committee.
5. After appointments are approved, the members of each committee shall select a Committee Chairperson from among the Commission members appointed to the committee.
6. Committees will be formed as needed.
7. Notice of all committee meetings and copies of all committee correspondence shall be filed with the Secretary and the Chairperson of the Commission. Committee findings which propose action or resolution shall be submitted at a regular meeting of the Commission for consideration.

#### Article VIII. Elections.

1. The Elections Board shall consist of a minimum of three (3) Commission Area residents appointed by the Chairperson with the approval of the Commission by the last regular meeting in April of each year. No individual running election night activities can be connected in any way with any candidate appearing on the ballot for the Commission. If no Elections Board is appointed, then all Commission members will make up the Elections Board.
2. The Board shall appoint any necessary officers; provide for printing and distributing necessary forms such as, but not limited to, petitions, ballots and tallies; receive petitions; certify persons who have qualified as candidates, locate polling places, conduct the election; tally the votes; hear and decide complaints concerning the election or campaign; and certify the winning candidates to the Commission pursuant to C.C. 3109 and the Selection Procedure, including all activities incidental thereto.
3. Candidates for selection shall not be polling staffs in year or years in which their names appear on the ballot.
4. Elections shall be by secret ballot and determined by plurality of vote if three (3) or more candidates vie for a single position, otherwise a majority of votes cast shall elect. Any person eighteen (18) years of age or older who is a resident of the Commission Area and the City of Columbus may be an elector. Electors need not be registered with the Franklin County Board of Elections. The initial election shall be conducted by a Task Force. Thereafter, each election shall be conducted by the Elections Board on the observance of "National Night Out" which is held on the first Tuesday in August. Members shall take office at the next annual meeting.
5. The Election Board shall adopt Election Rules for governing the elections by majority vote of its members provided such rules shall conform with these Bylaws and Selection Procedure. Such rules shall not be changed during the ninety (90) days before an election nor thirty (30) days after an election. The adoption of amendment of such Rules shall be presented to the Commission at the beginning of a regular meeting. Should the Commission not disapprove of them prior to adjournment, such Rules take effect. The Commission may amend the Election Rules without action by the Elections Board in the same manner as an amendment of these Bylaws.

#### Article IX. Parliamentary Authority

Robert's Rules of Order Newly Revised shall govern in all cases to which they are applicable and not inconsistent with these Bylaws and any special rules of order the Commission may adopt.

Article X.  
Amendments of  
Bylaws

These Bylaws may be amended at any regular meeting of the Commission by an affirmative vote of two-thirds (2/3) of the Commission Members provided that the amendment was submitted in writing at the previous regular meeting. The Secretary shall file any approved amendment immediately after its adoption with the City Clerk for publication in the City Bulletin. Such amendment shall take effect ten (10) days after such publication per C.C. 121.05.

Amended Bylaws as adopted this;  
Southwest Area Commission Chair

---

**Legislation Number:** PN0236-2018

**Drafting Date:** 9/20/2018

**Current Status:** Clerk's Office for Bulletin

**Version:** 1

**Matter** Public Notice

**Type:**

**Notice/Advertisement Title:** CITY TREASURER CITY OF COLUMBUS, OHIO APPLICATION FOR DEPOSIT OF PUBLIC MONEY

**Contact Name:** Deborah L. Klie

**Contact Telephone Number:** 614-645-7737

**Contact Email Address:** dlklie@columbus.gov

Notice is hereby given in accordance with Chapter 321 of the Columbus City Codes, 1959 to all banks, building and loan or savings associations or companies located in Franklin County, Ohio duly organized under the laws of the State of Ohio or of the United States, that application for deposit of public money for fiscal year 2019 will be accepted by the Columbus Depository Commission at the Office of the Columbus City Auditor, Secretary of said Commission, until 2:00 p.m., Tuesday, December 11, 2018.

Said application shall determine the eligibility of the applicant to receive active and inactive deposits from the Columbus City Treasurer for the period beginning January 1, 2019 and ending December 31, 2019. Said application shall be in such a form prescribed by the Commission and shall contain such information, as the Commission shall require.

Applications may be obtained from the Office of: Deborah L. Klie, City Treasurer, 90 West Broad Street, Columbus, Ohio 43215, telephone 645-7737.

All information and statements contained on said application shall be verified by affidavit.

Address envelope containing application to: Megan N. Kilgore, Secretary, Columbus Depository Commission, City Hall, 90 West Broad Street, Columbus, Ohio 43215.

By the order of the Columbus Depository Commission.

Deborah L. Klie, Chairperson

Megan N. Kilgore, Secretary

Joseph A. Lombardi, Member

---

**Legislation Number:** PN0247-2018

**Drafting Date:** 10/2/2018

**Current Status:** Clerk's Office for Bulletin

**Version:** 1

**Matter** Public Notice

**Type:**

**Notice/Advertisement Title:** The Columbus South Side Area Commission Election Dates

**Contact Name:** Paula J. Copeland, Esq.

**Contact Telephone Number:** 614-222-2145

**Contact Email Address:** [picopeland@sbcglobal.net](mailto:picopeland@sbcglobal.net) <<mailto:picopeland@sbcglobal.net>>

The Columbus South Side Area Commission Election Dates

October 1, 2018, 8 am. election packets ready for pick-up at Reeb Avenue Center

October 22, 2018 4:40 pm signed petitions due at Reeb Avenue Center

October 23, 2018, petitions reviewed

October 24, 2018, candidates notified

November 10, 2018, election day at Barack Recreation Center

---

**Legislation Number:** PN0261-2018

**Drafting Date:** 10/16/2018

**Current Status:** Clerk's Office for Bulletin

**Version:** 1

**Matter** Public Notice

**Type:**

**Notice/Advertisement Title:** Commission on Black Girls November Meeting

**Contact Name:** Nicole Harper

**Contact Telephone Number:** (614) 645-2933

**Contact Email Address:** [nnharper@columbus.gov](mailto:nnharper@columbus.gov)

The Commission on Black Girls will hold its November meeting on Thursday, November 15, 2018 beginning at 4 p.m. in the Central High Meeting Room at COSI, 333 W. Broad Street, Columbus, OH 43215.

Anyone who is interested in offering public testimony on the subject matter of the meeting (Justice, Child Welfare, and Safety) is invited to do so. Comments will be limited to three (3) minutes. If you wish to speak, a speaker slip must be completed. Speaker slips will be accepted between 8:00 a.m. until the meeting begins.

---

**Legislation Number:** PN0263-2018

**Drafting Date:** 10/17/2018

**Current Status:** Clerk's Office for Bulletin

**Version:** 1

**Matter** Public Notice

**Type:**

**Notice/Advertisement Title:** To Amend Chapter 251.03(a) of the Columbus City Health Code

**Contact Name:** Christina Wilson  
**Contact Telephone Number:** (614) 645-6197  
**Contact Email Address:** christinaw@columbus.gov

The following resolution will be presented at the Columbus Board of Health meeting on November 13, 2018 at 2:00 p.m.

**Resolution No. 18-20**

To amend Chapter 251.03(a) of the Columbus City Health Code in regard to the food service operation and retail food establishment fees in accordance with The State of Ohio Uniform Food Safety Code, law and rules.

**WHEREAS**, the staff of Columbus Public Health has traditionally provided licenses and conducted inspections for all food service operations and retail food establishments within the City of Columbus; and,

**WHEREAS**, the staff of Columbus Public Health has completed the cost analysis calculations required by Ohio Revised Code §3717.07 Uniform Cost Methodologies; Ohio Administrative Code, Cost Analysis and Calculations §3701-21-02.2; Cost Analysis and License Fee Calculation §901:3-4-04; and,

**WHEREAS**, the staff of Columbus Public Health recommend the following food service operation and retail food establishment license and facility layout & equipment specification review fees to recover current costs of the food protection program; and,

**WHEREAS**, the code establishes a new fee structure and cost methodology for establishing fees which is to go into effect on December 1, 2018; now, therefore

**BE IT RESOLVED BY THE BOARD OF HEALTH OF THE CITY OF COLUMBUS:**

**Section 1.** That licensing fees established by the state methodology be adopted by the Columbus Board of Health.

**Section 2.** That Section 251.03(a) of the Columbus City Health Code, Approval of Plans; Fees, be amended to read as follows:

Food Service Operation (FSO) and Retail Food Establishment (RFE) fees charged by Columbus Public Health shall be as follows (this amount is separate and in addition to the state fee that is included in the total license fee):

**2019 FEE SCHEDULE**

| TYPE   | CITY FEE   |
|--|------------|
| Risk Level 1 < 25,000 sq. ft. Commercial     | \$ 246.00  |
| Risk Level 2 < 25,000 sq. ft. Commercial     | \$ 270.00  |
| Risk Level 3 < 25,000 sq. ft. Commercial     | \$ 484.00  |
| Risk Level 4 < 25,000 sq. ft. Commercial     | \$ 600.00  |
| Risk Level 1 > 25,000 sq. ft. Commercial     | \$ 338.00  |
| Risk Level 2 > 25,000 sq. ft. Commercial     | \$ 338.00  |
| Risk Level 3 > 25,000 sq. ft. Commercial     | \$1,148.00 |
| Risk Level 4 > 25,000 sq. ft. Commercial     | \$1,214.00 |
| Risk Level 1 < 25,000 sq. ft. Non Commercial | \$ 123.00  |
| Risk Level 2 < 25,000 sq. ft. Non Commercial | \$ 135.00  |
| Risk Level 3 < 25,000 sq. ft. Non Commercial | \$ 242.00  |
| Risk Level 4 < 25,000 sq. ft. Non Commercial | \$ 300.00  |
| Risk Level 1 > 25,000 sq. ft. Non Commercial | \$ 169.00  |
| Risk Level 2 > 25,000 sq. ft. Non Commercial | \$ 169.00  |

|  |           |
|--|-----------|
| Risk Level 3 > 25,000 sq. ft. Non Commercial         | \$ 574.00 |
| Risk Level 4 > 25,000 sq. ft. Non Commercial         | \$ 607.00 |
| Mobile Food Service                                  | \$ 252.00 |
| Temporary Food Service Commercial (per day)          | \$ 48.00  |
| Temporary Food Service Non Commercial (per day)      | \$ 24.00  |
| Food Vending Locations                               | \$ 34.50  |
| Facility Layout & Equipment Specification Review     |           |
| Risk Level 1 < 25,000 sq. ft. Commercial             | \$ 200.00 |
| Risk Level 2-4 < 25,000 sq. ft. Commercial           | \$ 400.00 |
| Risk Level 1 > 25,000 sq. ft. Commercial             | \$ 400.00 |
| Risk Level 2-4 > 25,000 sq. ft. Commercial           | \$ 800.00 |
| Risk Level 1 < 25,000 sq. ft. Non Commercial         | \$ 100.00 |
| Risk Level 2-4 < 25,000 sq. ft. Non Commercial       | \$ 200.00 |
| Risk Level 1 > 25,000 sq. ft. Non Commercial         | \$ 200.00 |
| Risk Level 2-4 > 25,000 sq. ft. Non Commercial       | \$ 400.00 |
| Risk Level 1 Extensive Alteration < 25,000 sq. ft.   | \$ 100.00 |
| Risk Level 2-4 Extensive Alteration < 25,000 sq. ft. | \$ 200.00 |
| Risk Level 1 Extensive Alteration > 25,000 sq. ft.   | \$ 200.00 |
| Risk Level 2-4 Extensive Alteration > 25,000 sq. ft. | \$ 400.00 |

**Section 3.** That all previous fees specified in §251.03(a) for food service operation and retail food establishments be repealed. The expedited fees as specified in §251.03(b) shall remain unchanged.

**Legislation Number:** PN0264-2018

**Drafting Date:** 10/17/2018

**Version:** 1

**Current Status:** Clerk's Office for Bulletin

**Matter Type:** Public Notice

**Notice/Advertisement Title:** Livingston Area Commission Updated By-laws

**Contact Name:** Michael Herman

**Contact Telephone Number:** (614) 945-4105

**Contact Email Address:** mpjherman@gmail.com

The Livingston Avenue Area Commission has updated the commission by-laws. See attached.

**Legislation Number:** PN0266-2018

**Drafting Date:** 10/19/2018

**Version:** 1

**Current Status:** Clerk's Office for Bulletin

**Matter Type:** Public Notice

**Notice/Advertisement Title:** University Area Commission Elections

**Contact Name:** Doreen Uhas-Sauer

**Contact Telephone Number:** (614) 477-1124

**Contact Email Address:** Doreencolumbus@icloud.com

- o Oct. 27, 2018, Saturday, 10:00 am-4:00 pm: Election Day Polling locations are:
    - o Northside Branch of the Columbus Metropolitan Libraries, 1423 North High Street.
  - AND
  - o Northwood-High Building, 2231 N. High St.
- November 6, 6:30pm: Results certified by Election Committee.

**Legislation Number:** PN0267-2018

**Drafting Date:** 10/24/2018

**Current Status:** Clerk's Office for Bulletin

**Version:** 1

**Matter Type:** Public Notice

**Notice/Advertisement Title:** Development Commission Zoning Meeting Agenda - November 8, 2018

**Contact Name:** Shannon Pine

**Contact Telephone Number:** (614) 645-2208

**Contact Email Address:** spine@columbus.gov

The Development Commission of the City of Columbus will hold a public hearing on the following applications on **Thursday, November 8, 2018**, beginning at **6:00 P.M.** at the **MICHAEL B. COLEMAN GOVERNMENT CENTER** at 111 North Front Street, Columbus, OH 43215 in the **2ND FLOOR HEARING ROOM**.

Further information may be obtained by visiting the City of Columbus Zoning Office website at <http://www.columbus.gov/bzs/zoning/Development-Commission> or by calling the Department of Building and Zoning Services, Council Activities section at 614-645-4522.

**THE FOLLOWING APPLICATIONS WILL BE HEARD ON THE 6:00 PM AGENDA:**

**1. APPLICATION: Z17-033**

**Location:** 4970 SUNBURY ROAD (43230), being 22.58± acres located on the east side of Sunbury Road, 1,100± feet north of Morse Road (600-221810 & 600-233419; Northland Community Council).

**Existing Zoning:** L-R, Limited Rural District and L-C-3 and L-C-4, Limited Commercial districts.

**Request:** CPD, Commercial Planned Development District.

**Proposed Use:** Hotel.

**Applicant(s):** Key Hotel & Property Management, LLC; c/o Sean Mentel, Atty.; 100 South Fourth Street, Suite 100; Columbus, OH 43215.

**Property Owner(s):** SRI Easton Square LLC; 250 Civic Center Drive #500; Columbus, OH 43215.

**Planner:** Michael Maret; 614-645-2749; [mjmaret@columbus.gov](mailto:mjmaret@columbus.gov)

**2. APPLICATION: Z18-046**

**Location:** 2337 FUJI DRIVE (43229), being 1.2± acres located on the south side of Fuji Drive, 170± feet east of Spring Run Drive (010-104545; Northland Community Council).

**Existing Zoning:** P-1, Parking and L-C-4, Limited Commercial Districts.

**Request:** CPD, Commercial Planned Development District.

**Proposed Use:** Commercial uses.

**Applicant(s):** Mendoza Co., Inc; c/o Dave Perry, Agent; David Perry Company, Inc.; 411 East Town Street, 1st Floor; Columbus, OH 43215; and Donald Plank, Atty.; Plank Law Firm; 411 East Town Street, 2nd Floor; Columbus, OH 43215.

**Property Owner(s):** Central Ohio Community Improvement Corporation; c/o Curtiss L. Williams, Sr.;

845 Parsons Avenue; Columbus, OH 43206.

**Planner:** Michael Maret; 614-645-2749; [mjmaret@columbus.gov](mailto:mjmaret@columbus.gov)

### 3. APPLICATION: Z18-048

**Location:** 5721 CHERRY BOTTOM ROAD (43230), being 13.3± acres located on the west side of Cherry Bottom Road, 25± feet south of Clancy Court (111-298102 and 4 others; Northland Community Council).

**Existing Zoning:** R, Rural District.

**Request:** AR-1, Apartment Residential District.

**Proposed Use:** Multi-unit residential development.

**Applicant(s):** Oxford Circle LLC; c/o David Hodge, Atty.; Underhill & Hodge LLC; 8000 Walton Parkway, Suite 260; New Albany, OH 43054.

**Property Owner(s):** BZ Management Partners, et al.; 4444 Llewellyn Road; Columbus, OH 43230.

**Planner:** Michael Maret; 614-645-2749; [mjmaret@columbus.gov](mailto:mjmaret@columbus.gov)

### 4. APPLICATION: Z18-049

**Location:** 1367 FRANK ROAD (43223), being 0.70± acres located on the south side of Frank Road, 500± feet west of Hardy Parkway Street (570-126838 & 570-126305; Southwest Area Commission).

**Existing Zoning:** R-1, Residential District.

**Request:** M, Manufacturing District.

**Proposed Use:** Commercial vehicle parking.

**Applicant(s):** Sheryl A. Haushalter; 13670 US Highway 68; Kenton, OH 43326.

**Property Owner(s):** Breck's Real Estate, LLC; 13670 US Highway 68; Kenton, OH 43326.

**Planner:** Tim Dietrich; 614-645-6665; [tedietrich@columbus.gov](mailto:tedietrich@columbus.gov)

### 5. APPLICATION: Z18-051

**Location:** 5850 SUNBURY ROAD (43230), being 6.3± acres located on the east side of Sunbury Road, 1000± feet south of State Route 161 (110-000886 & 110-000698; Northland Community Council).

**Existing Zoning:** R, Rural District (Pending Annexation).

**Request:** L-ARLD, Limited Apartment Residential District.

**Proposed Use:** Multi-unit residential development.

**Applicant(s):** Metro Development LLC; c/o Jill S. Tangeman, Atty.; 52 East Gay Street; Columbus, OH 43215.

**Property Owner(s):** Lisa Pickens Silva; 5850 Sunbury Road; Columbus, OH 43230.

**Planner:** Michael Maret; 614-645-2749; [mjmaret@columbus.gov](mailto:mjmaret@columbus.gov)

### 6. APPLICATION: Z18-053

**Location:** 3522 WEST DUBLIN-GRANVILLE ROAD (43235), being 2.5± acres located at the northwest corner of West Dublin-Granville Road and Federated Boulevard (590-208810; Far Northwest Coalition).

**Existing Zoning:** CPD, Commercial Planned Developed District.

**Request:** CPD, Commercial Planned Developed District.

**Proposed Use:** Commercial development.

**Applicant(s):** 3540 WDG, LLC; c/o Jeffrey L. Brown, Atty.; 37 West Broad Street, Suite 460; Columbus, OH 43232.

**Property Owner(s):** 3540 WDG, LLC; 5087 Stonecroft Court; Hilliard, OH 43026.

**Planner:** Tim Dietrich; 614-645-6665; [tedietrich@columbus.gov](mailto:tedietrich@columbus.gov)

### 7. APPLICATION: Z18-055

**Location:** 5330 WARNER ROAD (43081), being 6.42± acres located at the northeast corner of Warner Road and North Hamilton Road (010-263114, 010-298433, 010-282434, and 010-2282435; Rocky Fork Blacklick Accord).

**Existing Zoning:** CPD, Commercial Planned Development District.

**Request:** CPD, Commercial Planned Development District.



**Proposed Use:** Commercial development.

**Applicant(s):** Sara Radcliffe, Atty.; 207 North Fourth Street; Columbus, OH 43215.

**Property Owner(s):** Christoff Land & Development LLC; 102 West Main Street, Suite 507; New Albany, OH 43054.

**Planner:** Michael Maret; 614-645-2749; [mjmaret@columbus.gov](mailto:mjmaret@columbus.gov)

**8. APPLICATION: Z18-044 (RECONSIDERATION)**

**Location:** 6069 ASTOR AVENUE (43232), being 0.52± acres located on the north and south sides of Astor Avenue, 215± feet west of Brice Road (550-156022 and 550-156023; Far East Area Commission).

**Existing Zoning:** R-1, Residential District.

**Request:** R-2F, Residential District.

**Proposed Use:** Two-unit dwellings.

**Applicant(s):** Greg Chalfant; 5801 East Livingston Avenue; Columbus, OH 43232.

**Property Owner(s):** The Applicant.

**Planner:** Tim Dietrich; 614-645-6665; [tedietrich@columbus.gov](mailto:tedietrich@columbus.gov)

**9. APPLICATION: Z18-047**

**Location:** 4464 PROFESSIONAL PARKWAY (43125), being 10.53± acres located on the north side of Professional Parkway, 860± feet east of Hamilton Square Boulevard, (010-215435 and 010-243274; Greater South East Area Commission).

**Existing Zoning:** L-C-2, Limited Commercial District.

**Request:** PUD-6, Planned Unit Development District.

**Proposed Use:** Multi-unit residential development.

**Applicant(s):** M Five LP; c/o Jill S. Tangeman, Atty.; 52 East Gay Street; Columbus, OH 43215.

**Property Owner(s):** The Applicant.

**Planner:** Shannon Pine; 614-645-2208; [spine@columbus.gov](mailto:spine@columbus.gov)

---

**Legislation Number:** PN0268-2018

**Drafting Date:** 10/25/2018

**Version:** 1

**Current Status:** Clerk's Office for Bulletin

**Matter** Public Notice

**Type:**

**Notice/Advertisement Title:** City Council Zoning Meeting, November 5, 2018

**Contact Name:** Monique Goins-Ransom

**Contact Telephone Number:** 614-645-0845

**Contact Email Address:** [mlgoins-ransom@columbus.gov](mailto:mlgoins-ransom@columbus.gov)

**REGULAR MEETING NO. 58 OF CITY COUNCIL (ZONING), NOVEMBER 5, 2018 AT 6:30 P.M. IN COUNCIL CHAMBERS.**

**ROLL CALL**

**READING AND DISPOSAL OF THE JOURNAL**

**EMERGENCY, TABLED AND 2ND READING OF 30 DAY LEGISLATION**

**ZONING: TYSON, CHR. E. BROWN M. BROWN PAGE REMY STINZIANO HARDIN**

**2528-2018** To grant a Variance from the provisions of Sections 3332.035, R-3, Residential District; 3312.21, Landscaping and screening; 3312.27(3),

Parking setback line; 3312.39, Striping and marking; 3312.43, Surface; 3312.49, Minimum number of parking spaces required; and 3321.07(B),

Landscaping, of the Columbus City codes, for the property located at 280 EAST INNIS AVENUE (43207), to permit a fraternal organization/private club with reduced parking and landscaping standards in the R-3, Residential District (Council Variance #CV18-014).

**2770-2018** To grant a Variance from the provisions of Section 3357.01, C-5 commercial district, of the Columbus City codes; for the property located at 865 NORTH WILSON ROAD (43204), to permit automotive sales in the C-5, Commercial District (Council Variance # CV18-018).

**2772-2018** To rezone 5020 GENDER ROAD (43110), 3.37± acres located at the southeast intersection of Gender Road and Chelsea Glen Drive, From: CPD, Commercial Planned Development and PUD-8, Planned Unit Development districts, To: CPD, Commercial Planned Development District (Rezoning #Z18-034).

**2928-2018** To grant a Variance from the provisions of Section 3356.03, C-4 permitted uses, of the Columbus City Codes; for the property located at 1581 PARSONS AVENUE (43207), to conform an existing single-unit dwelling in the C-4, Commercial District (Council Variance #CV16-020).

**2934-2018** To rezone 3700 PARSONS AVENUE (43207), being 0.43± acres located at the southeast corner of Parsons Avenue and Barcher Road, From: C-2, Commercial District, To: C-1, Commercial District (Rezoning#Z18-057).

**2935-2018** To grant a Variance from the provisions of Sections 3356.03, C-4 permitted uses; 3312.27, Parking setback line; 3372.804, Setback requirements; and 3377.05, Tables of elements for on-premises ground signs, of the Columbus City Codes; for the property located at 3469 SOUTH HIGH STREET (43207), to permit a self-storage facility with reduced development standards in the C-4, Commercial District, and to repeal Ordinance #0439-2014, passed July 28, 2014 (Council Variance #CV18-072).

**2940-2018** To rezone 6335 REFUGEE ROAD (43232), being 0.87± acres located on the west side of Gender Road, 330± feet south of Refugee Road, From: C-4, Commercial District, To: CPD, Commercial Planned Development District (Rezoning # Z18-032).

**2942-2018** To grant a Variance from the provisions of Sections 3332.035, R-3, residential district; and 3332.05(A)(4), Area district lot width requirements, of the Columbus City Codes; for the property located at 1515 OAK STREET (43205), to permit two-unit dwellings on two contiguous parcels with reduced lot width in the R-3, Residential District (Council Variance #CV18-038).

## ADJOURNMENT

---

**Legislation Number:** PN0271-2018

**Drafting Date:** 10/30/2018

**Version:** 1

**Current Status:** Clerk's Office for Bulletin

**Matter Type:** Public Notice

**Notice/Advertisement Title:** Columbus Graphics Commission November 13, 2018 Agenda

**Contact Name:** David Reiss

**Contact Telephone Number:** 645-7973  
**Contact Email Address:** djreiss@columbus.gov

**AGENDA**  
**GRAPHICS COMMISSION**  
**CITY OF COLUMBUS, OHIO**  
**NOVEMBER 13, 2018**

The City Graphics Commission will hold a public hearing on **TUESDAY, NOVEMBER 13, 2018 at 4:15 p.m.** in Room 205, 2nd floor of the Department of Building & Zoning Services, 111 North Front Street.

The City Graphics Commission hears requests for Variances, Special Permits, Appeals, Graphics Plans and certain Miscellaneous Graphics, as provided by the Columbus Graphics Code, Title 33, Article 15 of the City Codes.

**SPECIAL NOTE TO APPLICANT: YOU OR YOUR REPRESENTATIVE MUST ATTEND THIS MEETING.** It is the rule of the Commission to withdraw an application when a representative is not present.

**SIGN LANGUAGE INTERPRETER:** A Sign Language Interpreter, to “Sign” this meeting, will be made available for anyone with a need for this service, provided the Department of Building & Zoning Services is made aware of this need and given a reasonable notice of at least forty-eight (48) hours prior to the scheduled meeting time. To schedule an interpreter, please call 614-645-6373 or TDD 614-645-3293.

**01. Application No.: GC18-038**

**Location:** 3230 OLENTANGY RIVER ROAD (43202), located on the east side of Olentangy River Road, approximately 1500 feet south of West North Broadway. (010-266362)  
**Existing Zoning:** C-4, Commercial District  
**Request:** Variance(s) to Section(s):  
3372.806(A), Graphics.  
To allow automatic changeable copy in the Regional Commercial Overlay.  
**Proposal:** To legitimize an automatic changeable copy ground sign.  
**Applicant(s):** Morales Real Estate Investments  
3230 Olentangy River Road  
Columbus, Ohio 43202  
**Property Owner(s):** Applicant  
**Attorney/Agent:** Sign Affects, Ltd. c/o Brian Moody  
10079 Smith Calhoun Road  
Plain City, Ohio 43064  
**Planner:** Jamie Freise, (614) 645-6350; JFFreise@Columbus.gov

**02. Application No.: GC18-039**

**Location:** 1551 GEMINI PLACE (43240), located at the southwest corner of Gemini Place and Lyra Drive (318-431010180004; Far North Columbus Communities Coalition)  
**Existing Zoning:** L-C-4, Limited Commercial District  
**Request:** Variance(s) to Section(s):  
3377.10(B) Permanent on-premise ground signs.  
To install a ground sign directed to the same street as an existing side wall sign.  
**Proposal:** To install a ground sign.  
**Applicant(s):** Allen Industries, c/o David Brink  
7844 West Central Avenue  
Toledo, Ohio 43617  
**Property Owner(s):** Franz A. Geiger, Esq., N.P. Limited Partnership/Polaris AV, LLC  
880 Lyra Drive, Suite 550

Columbus, Ohio 43240

**Attorney/Agent:** Applicant

**Planner:** Eric R. Snowden, (614) 645-3526; [ERSnowden@Columbus.gov](mailto:ERSnowden@Columbus.gov)

[<mailto:ERSnowden@Columbus.gov>](mailto:ERSnowden@Columbus.gov)

**03. Application No.: GC18-040**

**Location:** **2200 IKEA WAY (43240)**, located on the north side of Ikea Way, approximately 900 feet east of Orion Place. (318-44202025006; Far North Columbus Communities Coalition)

**Existing Zoning:** L-C-4, Limited Commercial District

**Request:** Variance and Graphics Plan(s) to Section(s):  
3377.17, Setback regulations for permanent on-premises ground signs.  
To reduce the setback for ground signs from 15 feet to 11 feet.  
3377.26, Permanent on-premises roof signs.  
To allow a graphics for a roof sign.  
3377.22, Wall signs and building recesses.  
To allow wall signs to extend 2 feet 6 inches above the roofline.  
3377.24(D), Wall signs for individual uses.  
To allow a wall sign on an elevation that does not front a public right of way or have a public entrance, to allow it to be illuminated and to increase the allowable graphic area from 16 square feet to 80.6 square feet on the north elevation, to 86.2 square feet on the east elevation and to 86.2 square feet on the west elevation.  
3377.10(B), Permanent on-premises ground signs.  
To allow 2 projecting signs directed to the same street as a proposed ground sign.  
3377.18(A), Permanent on-premises projecting signs.  
To increase the number of allowed projecting signs from 1 to 2.

**Proposal:** A sign package to include multiple wall and ground signs as well as a sign that projects above the roof line.

**Applicant(s):** Swenson's Drive-In Restaurants  
680 East Cuyahoga Falls Avenue  
Akron, Ohio 44310

**Property Owner(s):** MG Rome Hilliard LLC  
3100 Tremont Road, Suite 200  
Columbus, Ohio 43221

**Attorney/Agent:** David Hodge, Arty  
8000 Walton Parkway, Ste. 260  
New Albany, Ohio 43054

**Planner:** Jamie Freise, (614) 645-6350; [JFFreise@Columbus.gov](mailto:JFFreise@Columbus.gov) [<mailto:JFFreise@Columbus.gov>](mailto:JFFreise@Columbus.gov)

**04. Application No.: GC18-042**

**Location:** **1103 MORSE ROAD (43224)**, located at the southeast corner of Morse Road and North 4th Street (010-103714; Northland Community Council)

**Existing Zoning:** CPD, Commercial Planned Development District

**Request:** Variance(s) to Section(s):  
3372.806(A)(C)(E), Graphics.  
To allow automatic changeable copy sign within the regional commercial overlay.

**Proposal:** To allow a gas price sign with automatic changeable copy.

**Applicant(s):** Speedway Superamerica, LLC  
539 South Main Street  
Findlay, Ohio 45840

**Property Owner(s):** Applicant  
**Attorney/Agent:** Stanley W. Young, III/Worthington Signs  
1510 Findlay Street  
Portsmouth, Ohio 45662  
**Planner:** Eric R. Snowden, (614) 645-3526; ERSnowden@Columbus.gov

**05. Application No.: GC18-045**

**Location:** **3430 OHIO HEALTH PARKWAY (43202)**, located at the terminus of Ohio Health Parkway, approximately 700 feet east of Olentangy River Road (010-183740)  
**Existing Zoning:** C-4, Commercial District  
**Request:** Graphics Plan(s) to Section(s):  
3377.26, Permanent on-premises roof signs.  
To allow a graphics plan for a roof sign.  
**Proposal:** To allow a graphics plan for two permanent on-premises roof signs.  
**Applicant(s):** Ohio Health Corporation  
3535 Olentangy River Road  
Columbus, Ohio 43202  
**Property Owner(s):** Applicant  
**Attorney/Agent:** SignCom, Inc., c/o Bruce Sommerfelt  
527 West Rich Street  
Columbus, Ohio 43215  
**Planner:** Jamie Freise, (614) 645-6350; JFFreise@Columbus.gov

**06. Application No.: GC18-036**

**Location:** **3740 WEST DUBLIN-GRANVILLE ROAD (43235)**, located on the northeast corner of Sawmill Road and West Dublin-Granville Road. (590-231114; Far Northwest Communities Coalition)  
**Existing Zoning:** CPD, Commercial Planned Development District  
**Request:** Special Permit & Variance(s) to Section(s):  
3377.11(A), Tenant panels and changeable copy.  
To increase the number of tenant panels for a ground sign from 4 to 10.  
3377.11(C), tenant panels and changeable copy.  
To increase the portion of a ground sign utilized to display tenant panels from 50% to 83%  
3377.11(D), Tenant panels and changeable copy.  
To reduce the portion of a ground sign utilized to identify the entire use from 50% to 17%.  
3378.01(D), General provisions.  
A special permit to allow the installation of a permanent off-premises ground sign.  
**Proposal:** To modify an existing ground sign by installing additional tenant panels and reducing the graphic area used to identify the entire use.  
**Applicant(s):** R&R Signs LLC/Tracy Fridenmaker  
11700 Winter Road  
Amanda, Ohio 43102  
**Property Owner(s):** The Huntington Bank  
5555 Cleveland Avenue  
Columbus, Ohio 43231  
**Attorney/Agent:** Applicant  
**Planner:** Eric R. Snowden, (614) 645-3526; ERSnowden@Columbus.gov

---

**Legislation Number:** PN0272-2018

**Drafting Date:** 10/30/2018

**Current Status:** Clerk's Office for Bulletin

**Version:** 1

**Matter** Public Notice

**Type:**

**Notice/Advertisement Title:** Design Rules and Regulations for Small Cells, Wireless Support Structures, & Associated Infrastructure

**Contact Name:** Frank Williams

**Contact Telephone Number:** 614-645-0584

**Contact Email Address:** fdwilliams@columbus.gov

**DEPARTMENT OF PUBLIC SERVICE**

**CITY OF COLUMBUS, OHIO**

**SUBJECT:** City Code Chapter 903 - Design Rules and Regulations for Small Cells, Wireless Support Structures, & Associated Infrastructure

**EFFECTIVE DATE:** November 13, 2018

**By:** Division of Infrastructure Management

## **1. Introduction**

### **1.1 Background**

Ohio House Bill 478 ("HB 478"), effective August 1, 2018, modifies the Ohio Revised Code concerning the regulation of wireless service deployed as small cell facilities within the municipal right-of-way. The law's intent is to promote the rapid deployment of small cell facilities within the right-of-way as part of the next generation of wireless service known as "5G". Municipalities are obligated to grant or deny consent in a timely manner, with the recognition that a municipality may adopt design guidelines for the purpose of reviewing proposed small cell facilities. Although exempt from HB 478, small cell facilities proposed for poles owned by the Department of Public Utilities should follow the design guidelines to follow.

### **1.2 Purpose**

The purpose of this document is to provide application procedures and design guidance for a number of potential buildout scenarios related to the deployment of small cell wireless facilities. The document will be used to:

- Provide uniformly applied criteria in a non-discriminatory fashion to all applicants;
- Support wireless service providers in the efficient deployment of small cell technology, to the benefit of residents, businesses, and visitors in the city of Columbus;
- Preserve and enhance the character of the city's neighborhoods and commercial corridors by ensuring that small cell deployments are appropriate for their given context;
- Inform the siting, design, landscaping, screening, camouflaging, public art opportunities, and other pertinent factors in the installation of small cell facilities;
- Promote small cell deployment that is of a high quality of design;
- Provide flexibility to allow for future technological advancements in small cells to be taken into account; and
- Comply with, rather than conflict with or preempt, all applicable state and federal laws, including relevant FCC rulings.

### **1.3 Applicability**

Placement or modification of a small cell facility and/or wireless support structure shall comply with these design guidelines at the time the permit for installation or modification is approved and as amended from time to time. These design guidelines are in addition to other rules and regulations promulgated pursuant to Title 9 and the Department of Public Service's ROW regulations. Wireless support structures owned by the Department of Public Utilities are exempt from the provisions of HB 478. Nonetheless, small cell facilities proposed on wireless support structures owned by the Department of Public Utilities should follow the design guidelines to follow, unless otherwise agreed to by written agreement with the Department of Public Utilities.

## 2. Application Types

### Existing Wireless Support Structure Applications

#### 2.1 Type 1: New Small Cell Facility

This type of application involves the installation of a new small cell facility on an existing structure within the right-of-way. This type of installation is referred to as collocation. This can occur on an existing utility pole, streetlight, traffic signal, or other existing pole. Attachments to poles owned by the Department of Public Utilities will require a separate agreement.

Standard Review Timeframe = 90 Days (Review timelines for attachment to poles owned by the Department of Public Utilities will comply with the pole attachment agreement.)

#### 2.2 Type 2: Substantial Modification of Small Cell Facility

This type of application involves the modification of a small cell facility on an existing structure within the right-of-way that is considered “substantial” under federal law, defined as:

- (1) *It increases the height of the structure by more than 10% or more than ten feet, whichever is greater;*
  - (a) *Changes in height should be measured from the original support structure in cases where deployments are or will be separated horizontally, such as on buildings’ rooftops; in other circumstances, changes in height should be measured from the dimensions of the wireless support structure, inclusive of originally approved appurtenances and any modifications that were approved prior to the passage of the Spectrum Act.*
- (2) *It involves adding an appurtenance to the body of the wireless support structure that would protrude from the edge of the structure by more than six feet;*
- (3) *It involves installation of more than the standard number of new equipment cabinets for the technology involved, but not to exceed four cabinets; or, for wireless support structures in the public rights-of-way, it involves installation of any new equipment cabinets on the ground if there are no pre-existing ground cabinets associated with the structure, or else involves installation of ground cabinets that are more than 10% larger in height or overall volume than any other ground cabinets associated with the structure; and/or*
- (4) *It entails any excavation or deployment outside the current site.*

Standard Review Timeframe = 90 Days

#### 2.3 Type 3: Non-Substantial Modification of Small Cell Facility

This type of application involves the modification of a new small cell facility on an existing structure within the right-of-way that is not considered “substantial” under federal law (see above definition of “substantial”). This type of install is referred to as an “eligible facility request”.

Standard Review Timeframe = 60 Days

### New Wireless Support Structure Application

#### 2.4 Type 4: New Small Cell Facility

This type of application involves the installation of a new small cell facility on a new wireless support structure within the right-of-way.

For Type 4 applications, the City of Columbus may request dedication of the new wireless support structure to the City of Columbus.

Standard Review Timeframe = 120 Days

### Replacement Wireless Support Structure Application

#### 2.5 Type 5: New Small Cell Facility

This type of application involves the installation of a new small cell facility on a new wireless support structure within the right-of-way that is replacing an existing wireless support structure at the same location. This may occur when the existing

pole does not meet the needs of the applicant or a proposed small cell facility would not meet the design guidelines as provided by the City of Columbus.

For Type 5 applications, the City of Columbus may request dedication of the new wireless support structure to the City of Columbus.

Standard Review Timeframe = 120 Days

### **3. Application Requirements**

#### **3.1 Pre-Application Meeting**

The City strongly recommends a pre-submittal meeting to meet with potential applicants and discuss projects on a conceptual level. The meeting is intended to identify the correct application type and content requirements for any given project, and also to create an informal forum in which applicants and the City can discuss any concerns that should be addressed as soon as possible to avoid any unnecessary delays in the processing of an application and deployment of wireless facilities in the City.

An appointment is required for all pre-submittal meetings. City staff may establish regular hours in which appointments are available. City staff will endeavor to provide applicants with an appointment within approximately five (5) business days after receipt of a written or email request. Each meeting is generally limited to discussion of up to five potential projects, but applicants may request to discuss additional projects provided that the additional time required does not impact other applicants' ability to obtain an appointment.

#### **3.2 Tolling of Applications**

The City will toll the timeline for review:

- (a) By mutual agreement between the applicant and the City,
- (b) In cases where the City determines the application is incomplete, or
- (c) When the number of applications is likely to result in difficulty processing them within the time limits noted under Application Types (Section 2) due to staff limitations. This would occur if the City received more than 90 applications within a consecutive 30 day period. For applications beyond the first 90, tolling shall be done as shown in Table 1 below.

Table 1 - Schedule of tolling of applications for small cell facility applications. (See page 5 of the attachment to this public notice named "PN0272-2018 - Design Document")

#### **3.3 Required Submittal Materials**

Prior to submitting an application, the applicant is strongly recommended to complete a pre-application meeting. Once completed, an official application may be submitted, to include:

1. A permit application per the Department of Public Service's requirements, to include, at a minimum:
  - a. Name of company seeking permit
  - b. Point of contact
    - i. Mailing address
    - ii. Email address
    - iii. Phone number
  - c. Written documentation of agent designation
2. Application Type (see Section 2).
  - a. For Type 1 and Type 2 applications, the City of Columbus, in order to encourage collocation of small cell facilities by different carriers, may request an access agreement allowing other carriers to use the same wireless support structure where technically feasible. Demonstrative proof must be provided as to why collocation is not feasible.
  - b. For Type 4 and Type 5 applications, the City of Columbus may request dedication of the new wireless support structure to the City of Columbus.



3. Permit Fee of \$250 (2018).
  - a. Future permit fees are as follow: \$275 (August 2023), \$300 (August 2028)
  - b. Fees for attachment to poles owned by the Department of Public Utilities will comply with the pole attachment agreement.
4. Fully dimensioned site plan (prepared, sealed, stamped, and signed by a Professional Engineer licensed and registered by the State of Ohio).
  - a. Must depict any existing nearby wireless facilities (including from other carriers), with all existing transmission equipment identified; other improvements; the proposed facility, with all proposed transmission equipment and other improvements; and the boundaries of the area surrounding the proposed facility and any associated access or utility easements and setbacks.
5. Fully dimensioned elevation drawings (prepared, sealed, stamped, and signed by a Professional Engineer licensed and registered by the State of Ohio).
6. Structural Calculations (prepared, sealed, stamped, and signed by a Professional Engineer licensed and registered by the State of Ohio).
7. Color sample of existing pole (if applicable) with proposed paint color for the small cell facility.
8. Photo simulations from a least three reasonable line-of-site locations near the proposed project site.
  - a. The photo sims must be taken from the viewpoints of the greatest pedestrian or vehicular traffic. Angle of photo sim separation must be at 90 degrees or greater and provide a full profile depiction.
  - b. Photo sims should include all cabling, conduit, RF stickers, and identification stickers.
  - c. For existing poles that are leaning and slated for replacement, the photo sim should show the proposed upright pole.
  - d. Photo sims should accurately reflect any proposed equipment offset from the pole
  - e. Include date of photo simulation
  - f. Photo sims should include all equipment proposed, including electric meter (if required), disconnect, and ground mounted equipment.
9. Equipment specifications:
  - a. Manufacturer name and model number
  - b. Physical dimensions including, without limitation, height, width, depth, volume and weight with mounts and other necessary hardware;
  - c. Technical rendering of all external components, including enclosures and all attachment hardware; and
  - d. The ambient noise level generated from the equipment, if any at 3 feet away and 10 feet away.
10. Landscape plans (for sites with ground-mounted equipment or cabinets)
  - a. Planting details
  - b. Plant species
  - c. Plant quantities
  - d. Spacing
  - e. Height/size at installation
  - f. Projected height/size at maturity
11. RF Compliance Affidavit
  - a. Applicants must submit a sworn affidavit prepared and signed by an RF engineer with knowledge about the proposed project that affirms the proposed project will be compliant with all applicable governmental regulations in connection with human exposure to radiofrequency emissions. The affidavit must include:
    - i. All frequencies on which the equipment will operate;
    - ii. How many channels will be used on each frequency;
    - iii. The effective radiated power ("ERP") output level in measured watts; and
    - iv. The height above ground for the lowest point on the lowest transmitter. The required disclosures above must be included for all transmitters on the support structure, which includes without limitation existing collocated antennas and a antennas used for wireless backhaul (such as microwave dish antenna or U/E relay).
12. A webmap with publicly downloadable GIS data displaying a current accounting of active small cell facility locations within the City of Columbus as of the application date (maintained in an ongoing fashion).

### 3.4 Incomplete Applications

If the City determines during its review that the application is incomplete, the City will notify the applicant and suspend further review until the missing items are provided. Consistent with state and federal requirements, the City will toll the

review timeline for incomplete applications. If the City determines the application is still incomplete after receipt of additional application materials, the City will toll the timeline again until the application is deemed complete

#### **4. Siting**

##### **4.1 Existing Utility Pole Siting Preferences**

The City of Columbus recognizes that every location is unique, however, the following list represents the City's preferences when siting small cells on existing City and non-City owned utility poles. The list is provided in order of preference, with number 1 being the most preferred.

1. Poles that have an existing small cell facility.
2. Guy stubs - Poles that do not have any electrical or communications; they simply provide a structural tie point for a guy wire for a neighboring pole
3. Poles with overhead secondary power conductors only (600 volts or less)
4. Primary electric poles with no attached equipment (with specific City approval for facilities owned by the Department of Public Utilities). Equipment includes transformers, reclosers, switches, capacitors, etc.)

##### **4.2 General Restrictions on New Wood Poles**

Collocation of small cell facilities on existing poles is a priority. Where a new pole is proposed at any location, the City reserves the right to require a metal pole rather than a wood pole based on the character of the proposed site location. In particular, new wood poles are strongly discouraged within the following areas:

1. Downtown District
2. East Franklinton District
3. University District
4. Historic Districts
  - a. Brewery District
  - b. German Village
  - c. Italian Village
  - d. Victorian Village
  - e. Other Historic Districts under the purview of the Historic Resources Commission
  - f. Other Historic Districts on the National Register of Historic Places
5. Areas with underground utilities

##### **4.3 New Pole Siting Preferences**

In all locations, the City reserves the right to require a metal pole rather than a wood pole based on the character of the proposed site location. New freestanding poles acting as wireless support structures for small cells should be located:

1. At the intersecting property line (parcel line) of two adjoining parcels wherever possible.
2. A minimum of 15 feet away from existing or planned street trees to avoid disturbing the root zone,
3. Spaced an equal distance between trees.
4. So as to not obstruct access to fire hydrants.
5. A minimum of 5 feet from driveways, entrances, or walkways.
6. Outside of the perpendicular extension of the primary street-facing wall plane for single unit and two unit residential buildings (see Figure 1 below)
7. At least 250 feet from other wireless support structures (proposed or existing), not including existing streetlights or utility poles.
8. Aligned within the same plane as existing trees, streetlights, utility poles, and other street furniture located in the amenity zone.
9. So as to not impede, obstruct, or hinder pedestrian, bicyclist, or vehicular travel
10. At least 2 feet from the travel way, edge line, face of curb, sidewalk, bike lane, or shared use path.
11. So as to adhere to existing neighborhood or district based streetscape improvement guidelines.
12. So as to not violate the Americans with Disabilities Act (ADA).
13. Outside of the clear vision triangle as determined by the Department of Public Service.

14. Away from storefront windows, when in a commercial areas, so as to not negatively impact said commercial establishment.

15. So as to not be positioned in front of an individually listed historic building, property or landmark (does not apply to buildings deemed historic as part of a historic district).

Figure 1 - (See page 9 of the attachment to this public notice named "PN0272-2018 - Design Document")

#### **4.4 Collocation on Existing Poles:**

In order to reduce visual clutter, the City encourages the collocation of small cell facilities on existing poles where feasible. If the applicant chooses not to collocate when options appear available, a statement must be provided as to why collocation is not feasible.

#### **4.5 Collocation with other Wireless Carriers:**

As noted previously, the City of Columbus seeks to support wireless service providers in the efficient deployment of small cell technology, to the benefit of residents, businesses, and visitors in the city of Columbus. To that end, the City supports the collocation of small cell facilities by different carriers on the same wireless support structure wherever possible. If the applicant chooses to not collocate when options appear available, a statement must be provided as to why collocation is not feasible.

#### **4.6 Existing Small Cell Facility Designs:**

Type 2 and Type 3 applications (i.e. modifications to existing small cell facilities) are to be reviewed for consistency with the Design Guidelines. At the time of the application for modifications, the City may request reasonable, technically achievable modifications that are consistent with the Design Guidelines. Additionally, the City encourages the modification of existing non-compliant small cell facilities that would result in facilities that are more consistent with the Design Guidelines.

### **5. Design Guidelines**

#### **5.1 General Design Guidance:**

1. **Concealment:** The design of any small cell facility should include concealment elements, including camouflaging and shrouding.

2. **Cabling:**

a. All cabling shall be hidden within conduit, shrouds, or by other concealment techniques.

b. For non-wood poles, underground cable or wires should transition directly into the pole base without any external junction box.

c. Excess cable shall not be spooled, coiled, or stored on the pole except within the approved shroud or cabinet

3. **Paint:** Antennas, brackets (mounting), equipment boxes (excluding ground mounted equipment), shrouds, meters, disconnects, conduits, and all other components of the small cell facility should be painted to match the color of the pole.

4. **Equipment Lighting:** Unless otherwise required for compliance with FAA or FCC regulations, the facility shall not include any permanently installed lights. Any lights associated with the electronic equipment shall be appropriately shielded from public view. This guideline is not meant to prohibit installations on streetlights or the installation of luminaires or additional street lighting on new poles when required by the City.

5. **Advertisement:** All manufacture equipment labels shall be removed, covered (i.e. by shrouding), or painted to match the pole and other equipment. Visibly depressed or indented manufacturer logos or names should be avoided, or filled in to match the equipment.

6. **Vaulting:** Installation in Underground Area: Where existing equipment and utilities are located underground, the City may at its discretion, require the installation of pad-mounted or vault-mounted equipment. Undergrounding of utilities is generally encouraged throughout the City.

7. **Height:**

a. The height of new wireless support structures, including the small cell facility itself, should not exceed 40 feet, except in areas where the predominant character is industrial in nature, in which case the height should not exceed 50 feet.

b. For an existing wireless support structure, the antenna and any associated shroud may be located at the top of the existing structure, but may not increase the height be more than 5 feet.

8. **Stickers:** Excessive stickers are discouraged. Where stickers are required by FCC regulation or for identification, the

background of the sticker should match the color of the equipment, with black lettering, unless otherwise required by law.

a. **RF Warning Labels:** Utilize the smallest and lowest visibility RF warning stickers required by law, with the sticker placed as close to the antenna as possible.

- i. For areas with nearby residential, place the sticker facing the street.
- ii. Otherwise, place the sticker facing away from the street.

b. **Identification Label:** Identification of the small cell facility owner should be limited to a single sticker no larger than 4 inches by 6 inches. The background of the sticker should be the same color as the equipment, and should be placed on the bottom of the equipment shroud if possible. Alternatively, the label may be placed on the equipment opposite the direction of vehicular travel on the adjacent roadway. The label should include:

- i. Carrier name
- ii. Location identification information
- iii. Emergency telephone number

## 5.2 Antenna Design Guidance:

### 1. Antennas:

a. The antenna(s) associated with the first installation should be top-mounted and concealed within a radome that also conceals the cable connections, antenna mount and other hardware.

b. Top-mounted antennas should be directly mounted to the pole or utilize a short extension that is full shrouded. Very tall extensions are generally not supported.

c. Top-mounted antennas should be centered on the pole, not offset.

d. Top-mounted antennas should be the same diameter of the pole at the point of attachment, and should appear as a seamless vertical extension of the pole.

e. When a larger diameter antenna is required, the diameter should be no larger than 14 inches in diameter and include a smooth tapered shroud from the pole to the antenna.

f. Top-mounted antennas should be no larger than 5 feet tall, including the antenna itself, radio head, mounting bracket, and all other hardware necessary for a complete installation.

g. The antennas should be non-reflective and painted to match the pole (wireless support structure).

h. Top-mounted antennas should not be installed on poles with primary electric wires. All antennas on primary electric poles shall be installed in the pole's communication space.

i. The City may approve one side-mounted antenna per pole with the initial installation, in lieu of a top-mounted antenna, if, in the City's discretion, the side-mounted antenna would be more appropriate given the built environment, neighborhood character, and overall site appearance.

j. Side-mounted antennas should conceal all cabling within the antenna arm extension.

k. Side-mounted antennas should be installed parallel to the roadway.

l. Antenna may not exceed 6 cubic feet in volume

2. **Wireless Backhaul:** The City generally discourages the use of microwave or other wireless backhaul that requires additional or separate antennas, with wired backhaul being preferred.

3. **GPS Antennas:** Where necessary for the operations of the small cell facility, GPS antennas should be built into the proposed primary antenna rather than added after the fact.

## 5.3 Electric Meter Design Guidance:

1. **Flat Rate:** Generally, utility-grade metering is preferred. However, flat rate electric service may be negotiated for installations where a "glass bubble" meter is impractical.

2. **Glass Bubble Meter:** If a glass bubble meter is proposed, the applicant should use a meter with a slim profile cabinet as shown in Figure 2.

3. **One Meter:** For poles with multiple wireless carriers, one electric meter (if present, or required) should serve all carriers, if feasible.

4. **Disconnect Switches:** Place disconnect switches above or below the meter (when present) rather than to the side of the meter.

Figure 2 - (See page 13 of the attachment to this public notice named "PN0272-2018 - Design Document")

#### 5.4 General Equipment Design Guidance:

1. **Number of Shrouds:** Generally, only one equipment shroud, containing all required small cell equipment, should be installed per pole. In cases where there are multiple wireless carriers using a pole, equipment shrouds should be the same width and color and stacked to present a unified design aesthetic.

2. **Sound:** Passive cooling (no noise generation) is preferred. If active cooling is required, the following guidelines apply for sound limits.

- a. Goal of less than 30 decibels within 3 feet of any property line.
- b. Maximum of 45 decibels within 3 feet of any residential property line or park
- c. Maximum of 55 decibels within 10 feet of all other property lines

3. **Equipment, Cabling, & Conduit Attachments:**

a. For existing and proposed wood poles, all equipment, cabling, & conduit attachments should be flush with the pole.

b. All wires, cables, and connections shall be located within the smallest diameter channel, conduit, u-guard, or shroud feasible, with a maximum diameter of 4", painted to match the pole.

c. If existing pole limitations restrict this, pole replacement should be considered.

d. If an offset from the pole is necessary for equipment, the shroud should include wings that fully conceal the offset.

#### 5.5 Pole Mounted Equipment:

1. When pole-mounted equipment is either permitted or required, all equipment other than the antenna(s), electric meter and disconnect switch must be concealed within an equipment shroud.

2. The equipment should be installed no lower than 15 feet above ground level.

3. The equipment shroud must be non-reflective and painted to match the existing pole.

4. It is preferred that equipment shrouds be mounted flush to the pole, subject to the pole owner's approval.

5. Standoff mounts are permitted for the equipment shroud, but may not exceed six (6") inches and must include metal flaps (or "wings") to conceal the space between the shroud and the pole.

5. Pole mounted equipment, including shrouds, should be long and narrow, with a target width equal to that of the pole.

6. Pole mounted equipment, including shrouds, should face away from nearby residential windows, where present.

7. The equipment shroud, electric meter, and disconnect should be placed on the same side of the pole and stacked as closely as possible along a common centerline.

8. Equipment may not exceed 28 cubic feet in volume

#### 5.6 Ground Mounted Equipment Design Guidance:

1. Where ground mounted equipment or boxes are proposed the following apply:

a. **Suburban Commercial Areas -**

i. Ground mounted equipment should be 100% screened using evergreen plant material and shown on the landscape plan.

ii. The ground mounted equipment should be painted to blend in with the landscaped screening to the greatest extent possible.

b. **Urban Commercial Areas -**

i. Ground mounted equipment is discouraged, with vaulting encouraged for areas where utilities are located underground.

ii. Ground mounted equipment may be supportable if located in a box with a public art wrap (Columbus Art Commission review may be necessary) or camouflaged as part of a street furniture option or bus shelter. See Figure 3 for an example of each.

Figure 3 - (See page 15 of the attachment to this public notice named "PN0272-2018 - Design Document")

#### 5.7 New Pole Design Guidance:

1. **New Poles with Blank Connections:** The City may require that for Type 4 and Type 5 applications, that the new

pole include blank connections for City use such as cameras, food truck connections, wi-fi, wayfinding signage, or banners.

- a. A minimum of 15% of the pole design structural capacity shall be reserved for future City installations.

**2. New Integrated & Standalone Metal Poles:**

- a. Base equipment cabinet should be round to match diameter below.
- b. Base equipment cabinet preferred diameter is 16 inches, with a maximum of 20 inches.
- c. A decorative transition or base cover should be installed as a transition to the pole
- d. Base equipment cabinet should be no taller than 5 feet in height.
- e. Base equipment cabinet shall not have a continuous horizontal surface greater than 1.5 inches, to avoid accumulation of debris and litter,
- f. Pole should create a cohesive architectural aesthetic

Figure 4 - (See page 17 of the attachment to this public notice named "PN0272-2018 - Design Document")

Figure 5 - (See page 18 of the attachment to this public notice named "PN0272-2018 - Design Document")

BY ORDER:

JENNIFER GALLAGHER, DIRECTOR  
DEPARTMENT OF PUBLIC SERVICE



---

**Legislation Number:** PN0274-2018

**Drafting Date:** 10/30/2018

**Current Status:** Clerk's Office for Bulletin

**Version:** 1

**Matter** Public Notice

**Type:**

**Notice/Advertisement Title:** Public Hearing on 2019 Proposed Utilities Rate Adjustments

**Contact Name:** Kevin McCain

**Contact Telephone Number:** (614) 645-5829

**Contact Email Address:** KBMcCain@columbus.gov

Columbus City Council invites interested persons to attend a public hearing on Thursday - November 15, 2018 at 5:00 P.M. in City Council Chambers. The purpose of the hearing is to review and comment on the proposed 2019 Water and Sewage Rates for the City of Columbus. Also being discussed will be payment assistance programs for low income residents and seniors using City of Columbus Utilities. Representatives from the Department of Public Utilities will be on hand to answer questions.

**Date:** Thursday - November 15, 2018

**Time:** 5:00pm

**Location:**

City Hall

Columbus City Council Chambers

90 West Broad Street

Columbus, OH 43215

Public testimony will be accepted. Those wishing to address City Council regarding this issue can fill out a speaker slip at City Hall between the hours of 8:00am and 5:00pm on the day of the hearing.

This hearing will be available streaming live on the CTV website. It will also be made available to the public on the Columbus.gov YouTube channel after the event.

---

**Legislation Number:** PN0275-2018

**Drafting Date:** 10/31/2018

**Current Status:** Clerk's Office for Bulletin

**Version:** 1

**Matter** Public Notice

**Type:**

**Notice/Advertisement Title:** Board of Industrial Relations

**Contact Name:** William Gaines

**Contact Telephone Number:** 614-645-5436

**Contact Email Address:** wgaines@columbus.gov

The Board of Industrial Relations holds regular meetings on the 3rd Monday of each month at 1:30pm in Hearing Room #134, 77 N. Front Street, Columbus Ohio 43215

---

**Legislation Number:** PN0276-2018

**Drafting Date:** 10/31/2018

**Current Status:** Clerk's Office for Bulletin



Version: 1

Matter Public Notice  
Type:

Notice/Advertisement Title: Civil Service Commission Public Notice

Contact Name: Wendy Brinnon

Contact Telephone Number: (614) 645-7531

Contact Email Address: wcbriannon@columbus.gov

During its regular meeting held on Monday, October 29, 2018, the Civil Service Commission passed a motion to revise the specification for the classification Sports Field Maintenance Worker, assign a probationary period of 365 days, designate the examination type as competitive, and amend Rule XI accordingly.

During its regular meeting held on Monday, October 29, 2018, the Civil Service Commission passed a motion to amend Rule VII (B)(7)(a), (b) and (c) to expand available opportunities for examination candidates to roll previous exam results to newly administered exams for the same job classification for which they have been approved to test.

During its regular meeting held on Monday, July 30, 2018, the Civil Service Commission passed a motion to revise Rule XV(B)(1) pertaining to Leaves of Absence Without Pay.

---

Legislation Number: PN0279-2018

Drafting Date: 11/1/2018

Current Status: Clerk's Office for Bulletin

Version: 1

Matter Public Notice  
Type:

Notice/Title: RULE AND REGULATION NO. 18-02/WATER TAP SERVICE REQUIREMENTS

Contact Name: Virginia Dorsey

Contact Telephone Number: (614) 645-7541

Contact Email Address: vldorsey@columbus.gov

OFFICIAL NOTICE

WATER SERVICE TAP REQUIREMENTS

RULES AND REGULATIONS NO. 18-02

Division of Water Department of Public Utilities

See Attached

---

Legislation Number: PN0280-2018

Drafting Date: 11/1/2018

Current Status: Clerk's Office for Bulletin

Version: 1

Matter Public Notice  
Type:

Notice/Advertisement Title: Building and Zoning Services Proposed Changes to the Fee Schedule

Contact Name: Carl G. Williams

Contact Telephone Number: (614) 645-0854

Contact Email Address: [cgwilliams@columbus.gov](mailto:cgwilliams@columbus.gov) <<mailto:cgwilliams@columbus.gov>>

**What:** Columbus City Council Member Priscilla R Tyson, Chair of Columbus City Council's Zoning Committee will host a public hearing to review changes which have been proposed to the fee schedule for the Department of Building and Zoning Services. The Director of the Department of Building and Zoning Services and his staff will present an overview of the proposed changes.

**When:** Wednesday, November 14, 2018 at 4:00 p.m.

**Where:** Columbus City Hall  
City Council Chambers, 2nd Floor  
90 West Broad Street  
Columbus, OH 43215

**Public Testimony:**

Public testimony will be accepted. Anyone wishing to address City Council on this matter must fill out a speaker slip before 4:00 p.m., on the day of the said hearing. The meeting will broadcast live on CTV, Columbus' cable access Channel 3.

---

**Legislation Number:** PN0281-2018

**Drafting Date:** 11/1/2018

**Version:** 1

**Current Status:** Clerk's Office for Bulletin

**Matter Type:** Public Notice

**Notice/Advertisement Title:** LOCAL LIMITS FOR THE CONTROL OF DISCHARGES OF WASTEWATER TO THE COLUMBUS SEWERAGE SYSTEM

**Contact Name:** Virginia Dorsey

**Contact Telephone Number:** (614) 645-7541

**Contact Email Address:** vldorsey@columbus.gov

OFFICIAL NOTICE

LOCAL LIMITS FOR THE CONTROL OF DISCHARGES OF WASTEWATER TO THE COLUMBUS SEWERAGE SYSTEM

RULES AND REGULATIONS NO. 18-03

Division of Sewerage and Drainage Department of Public Utilities

See Attached

---

**Legislation Number:** PN0282-2018

**Drafting Date:** 11/2/2018

**Version:** 1

**Current Status:** Clerk's Office for Bulletin

**Matter Type:** Public Notice

**Notice/Advertisement Title:** Livingston Avenue Area Commission Election Results

**Contact Name:** Michael Herman  
**Contact Telephone Number:** (614)580-8365  
**Contact Email Address:** mpherman@gmail.com

The Livingston Avenue Area Commission (LAVA-C) Election for the office of Commissioner was held November 1, 2018.

**The official election results are as follows:**

David Gray - 78 votes  
Jennifer Thomas - 69 votes  
Jeremy Wachtel - 62 votes  
Andrew Verhage - 61 votes  
Mustafaa Shabazz - 54 votes  
Brenten Johnson - 48 votes  
Mario Fleming - 45 votes

David Gray, Jennifer Thomas and Jeremy Wachtel will serve in the three (3) open seats for a full three year term (Jan 2019 - Dec 2021); Andrew Verhage will serve the remainder of the vacant seat for a one (1) year term (Jan 2019 - Dec 2019).

On behalf of the Election Committee I would like to thank everyone who came out to vote last night.

Michael P.

---

**Legislation Number:** PN0283-2018

**Drafting Date:** 11/2/2018

**Version:** 1

**Current Status:** Clerk's Office for Bulletin

**Matter** Public Notice

**Type:**

**Notice/Advertisement Title:** September 2018 Update Period List of Registered Active Legislative Agents

**Contact Name:** James Lewis

**Contact Telephone Number:** (614) 724-4690

**Contact Email Address:** jalewis@columbus.gov

[See Attached.](#)

---

**Legislation Number:** PN0289-2017

**Drafting Date:** 12/19/2017

**Version:** 1

**Current Status:** Clerk's Office for Bulletin

**Matter** Public Notice

**Type:**

**Notice/Advertisement Title:** Big Darby Accord Advisory Panel 2018 Schedule

**Contact Name:** Festus Manly-Spain

**Contact Telephone Number:** (614) 645-8062

**Contact Email Address:** famanly-spain@columbus.gov

Meeting Accommodations: It is the policy of the City of Columbus that all City-sponsored public meetings and events are accessible to people with disabilities. If you need assistance in participating in this meeting or event due to a disability as defined under the ADA, please call the City's ADA Coordinator at (614) 645-8871 or e-mail [zdjones@columbus.gov](mailto:zdjones@columbus.gov) at least three (3) business days prior to the scheduled meeting or event to request an accommodation.

Application Deadline                      Hearing Date  
Franklin County Courthouse  
373 S. High St., 25th Fl. - Room B  
1:30PM

|                    |                    |
|--------------------|--------------------|
| December 12, 2017  | January 9, 2018    |
| January 16, 2018   | February 13, 2018  |
| February 13, 2018  | March 13, 2018     |
| March 13, 2018     | April 10, 2018     |
| April 10, 2018     | May 8, 2018        |
| May 15, 2018       | June 12, 2018      |
| June 12, 2018      | July 10, 2018      |
| July 17, 2018      | August 14, 2018    |
| August 14, 2018    | September 11, 2018 |
| September 11, 2018 | October 9, 2018    |
| October 16, 2018   | November 13, 2018  |
| November 13, 2018  | December 11, 2018  |

Applications should be submitted by 5:00pm on deadline day to:

City of Columbus Planning Division  
Attn: Festus Manly-Spain  
50 W. Gay St. 4th Fl.  
Columbus OH 43215

**NOTE:**

Application delivery will be 111 N. Front St., 3rd floor. starting in March.  
You may also check the Commission webpage for information.

---

**Legislation Number:** PN0290-2017

**Drafting Date:** 12/19/2017

**Version:** 1

**Current Status:** Clerk's Office for Bulletin

**Matter** Public Notice

**Type:**

**Notice/Advertisement Title:** Rocky Fork-Blacklick Accord 2018 Meeting Schedule

**Contact Name:** Festus Manly-Spain

**Contact Telephone Number:** (614) 645-8062

**Contact Email Address:** famanly-spain@columbus.gov

Meeting Accommodations: It is the policy of the City of Columbus that all City-sponsored public meetings and events are accessible to people with disabilities. If you need assistance in participating in this meeting or event due to a disability as defined under the ADA, please call the City's ADA Coordinator at (614) 645-8871 or e-mail [zdjones@columbus.gov](mailto:zdjones@columbus.gov) at least three (3) business days prior to the scheduled meeting or event to request an accommodation.

Application Deadline                      Hearing Dates

New Albany Village Hall  
99 W. Main St.  
New Albany, OH 43054

6:00pm

December 21, 2017  
January 18, 2018  
February 15, 2018  
March 22, 2018  
April 19, 2018  
May 24, 2018  
June 21, 2018  
July 19, 2018  
August 3, 2018  
September 20, 2018  
October 18, 2018  
November 22, 2018\*

January 18, 2018  
February 15, 2018  
March 15, 2018  
April 19, 2018  
May 17, 2018  
June 21, 2018  
July 19, 2018  
August 16, 2018  
September 20, 2018  
October 18, 2018  
November 15, 2018  
December 20, 2018

\*Application deadline date changed due to Holiday...office may close early

Applications should be submitted by 5:00pm on deadline day to:

City of Columbus Planning Division  
Attn: Festus Manly-Spain  
50 W. Gay St. 4th Fl.  
Columbus OH 43215

**NOTE:**

Application delivery will be 111 N. Front St., 3rd floor. starting in March.  
You may also check the Commission webpage for information.

## **WESTLAND AREA COMMISSION BY-LAWS**

### **ARTICLE I. PURPOSE**

The Commission shall be an advisory body, established to participate in planning, decision making and to facilitate communication, understanding and cooperation between neighborhood groups, city officials and developers in the Westland Area including:

- A. The Commission shall in the interests of local planning for local needs, identify and study the problems and requirements of the commission area in order to create plans and policies which will serve as guidelines for future development of the area; bring the problems and needs of the area to the attention of appropriate government agencies; recommend solutions or legislation.
- B. To aid and promote communications within the commission area and between it and the rest of the city, including public forums and surveys to provide opportunity for area residents, businesses and organizations to state their problems and concerns; also to solicit active participation and open communication with all segments of the commission area organizations, associations, institutions, businesses and governmental entities, including but not limited to Prairie, Franklin, Pleasant, and Jackson townships.
- C. To initiate, review and recommend criteria and programs for the preservation, development and enhancement of the commission area, including but not limited to parks, recreational areas, schools, traffic and streets, be they commercial or residential.
- D. To recommend priorities for and review of government services and the operation of the various government departments in the commission area by means of:
  - 1. Requesting and receiving from departments or agencies, prior to implementation, full reports concerning governmental services or practices in the area.
  - 2. Meeting with administrative heads of any department or agency, or any of their subordinates, to obtain additional information deemed necessary for the commission to fulfill its functions.
  - 3. Requesting and receiving from departments or agencies, prior to implementation, full reports on any proposed changes in service or practice in the area and recommending approval or disapproval of the proposed changes.
  - 4. Reviewing and evaluating pending legislation substantially affecting the area prior to its consideration by council; and
  - 5. Regularly receiving for review, comment and recommendation from the Division of Regulations copies of applications and notices of all public hearings related to rezoning, special permits, variances, demolitions and zoning appeals regarding property located wholly or partially within the area.

## WAC BY-LAWS 2018

- E. To recommend persons for nomination to membership on city boards and commissions which make decisions or recommendations affecting the commission area.
- F. No duty or function of the Westland Area Commission shall invalidate any action of Council.

## ARTICLE II. BORDERS

### Section 1. WESTLAND AREA COMMISSION

The borders of the Westland Area Commission shall be from the junction of the centerline of I-270 and the centerline of Big Run South Road:  
thence north along the centerline of I-270 to the Conrail RR tracks,  
thence west to the western fork of Hellbranch Creek,  
thence south along the creek to its intersection with the centerline of Grove City Road,  
thence east by northeast along the centerline of Grove City Road to the centerline of Big Run South Road,  
thence northeast along the centerline of Big Run South Road to its intersection with the centerline of I-270.

## ARTICLE III. MEMBERSHIP

**Section 1.** All commissioners shall be appointed by the Mayor of the City of Columbus in accordance with Chapter 3313 of the City Codes. The Recording Officer shall notify the Mayor of all nominations, elections, and vacancies within ten days of such action.

- A. Should the Mayor neither approve nor disapprove of the action within thirty days of notification, the action shall be deemed approved.
- B. A copy of each such notice shall be sent to the City council (care of the City Clerk) and to the proper official of the Division of Neighborhood Services.

**Section 2.** The Westland Area Commission (WAC) shall consist of twenty-one commissioners.

- A. Fourteen (14) commissioners shall be elected from the Westland Area. The 14 commissioners shall be elected in accordance to the Selection Rules adopted by the WAC. All elected commissioners shall maintain a residence, work or own property in the Westland Area during their term of office.
- B. Seven (7) commissioners, who need not be Westland Area residents, shall be nominated by the Commission. The five (5) individuals nominated by the commission will be made from professionals and individuals as follows, but not limited to, one (1) official from South-Western City Schools; one (1) Doctor Hospital, one (1) from the Southwest Public Library and three (3) representatives from businesses, one of which shall be from the Westland Area Business Association

WAC BY-LAWS 2018

(WABA), one (1) community leader.

C. All commissioners shall have equal voting rights.

**Section 3.** Terms of offices for all commissioners, both selected and nominated shall be three years..

A. Westland Area Commission commissioners shall serve without compensation.

B. The Commission year shall commence at the annual meeting, which is the October meeting, and shall last for twelve (12) consecutive months ending in September.

C. Absence from four regular, special and interim meetings in one year shall be considered a resignation from the Commission. The Recording Officer shall give notice to both the Chairperson and the individual commissioner after that person has been absent for three total meetings.

1. Absence from a commission meeting shall be excused when the commissioner acts as an official representative of the Westland Area Commission at a meeting which conflicts with the Westland Area Commission meeting date and time.
2. Absence from a commission meeting shall be excused when the commissioner notifies the Recording Officer in writing at least three days in advance of the meeting that the Commissioner is unable to attend. An emergency excuse will be granted if the Commissioner contacts at least one the of the Commission officers before the meeting starts. If any three commissioners indicate disagreement with the excused status in this paragraph, they may call for a ballot and deny the "excused" with a two-thirds vote of the full commission.
3. The Recording Officer shall maintain an attendance roster indicating "Present", "Unexcused", or "Excused" for each meeting. Tardiness and leaving before adjournment shall be recorded in the official records unless excused the Chairperson.

D. Vacancies shall be filled according to the following procedures:

1. If the vacancy occurs in a position and the time remaining is less than five months, the position shall be declared vacant by the Chairperson until the next election date.
2. If the vacancy occurs in an elected position, replacement commissioners shall be selected from the candidates nominated at a regularly scheduled meeting either by the nominating committee or from the floor. This will be done by a vote of the commissioners present. A yes vote by a majority of the commissioners present shall upon approval by the Mayor fill the position until the next annual election.

E. No commissioner shall represent the WAC in its official actions except as specifically authorized by a majority at a regular or special meeting. This shall not be construed as a restriction upon the rights of individual commissioners to represent their own views before public or private bodies, whether in agreement or disagreement with the official actions of the Commission.



F. All terms shall be for three years, except for the appointed terms as described in section 3(D)2.

## ARTICLE IV. OFFICERS

**Section 1.** The officers of the Westland Area Commission shall be: Chairperson, Vice-Chairperson, Recording Officer and Fiscal Officer.

**Section 2.** Officers shall be elected for a term of three years.

**Section 3.** Elections of officers shall be held at the first regular meeting after the annual (October) meeting by approval of a majority vote of those commissioners present at the meeting.

A. The Nominating Committee shall, two regular meetings prior to the elections of officers, request that any commissioners interested in becoming officers notify the Committee of their intent. One regular meeting prior to the election date, the Nominating Committee shall present the proposed slate of candidates to the Commission. Nominations for the candidates shall be accepted by the Chairperson on the day of the election. Only commissioners who have served on the Commission for at least nine months may run for an office.

**Section 4.** Duties of the officers shall be as follows:

- A. **The Chairperson** shall preside at all meetings of the Commission. The Chairperson shall prepare an agenda for all meetings and appoint commissioners and Chairpersons for all standing and special committees, with the advisement of other officers. Standing committee Chairpersons and commissioners shall be appointed at a regular meeting following the election of the Commission Chairperson. The Chairperson shall perform other duties associated with the position as required, including to fill officer positions that become vacant during the Chairperson's term.
- B. **The Vice Chairperson** shall perform the duties of the Chairperson in the absence of that officer and shall perform such special duties that may arise, at the request of the Chairperson.
- C. **The Recording Officer** shall call and record the roll, record all voting results, record the minutes of the Commission meetings (the taking of minutes may be designated to an individual, approved by the commission, and not a part of the commission), maintain a file of Commission correspondence and other records as directed by the Chairperson. Additionally, the Recording Officer shall provide a quarterly attendance roster to the Chairperson. The Recording Officer shall notify the Mayor of all nominations, elections, and vacancies within ten days of such action. Minutes of all meetings, voting results and attendance records shall be maintained by the Recording Officer at a public facility for examination by any interested party. The Recording Officer shall provide copies, at a reasonable charge, of any WAC documents to any person requesting them.
- D. **The Fiscal Officer** shall receive, disburse and record all funds of the Commission. Expenditures over \$20.00 require advance permission from the Chairperson. Quarterly financial records shall

## WAC BY-LAWS 2018

be furnished to the Recording Officer for inclusion in the Commission records maintained for public examination.

### **Section 5.** The order of succession.

- A. If the Chairperson resigns, then the Vice Chairperson will assume the position for the remainder of the Chairperson's term of office. At the next regular meeting, the first order of business will be the election of a new Vice Chairperson from the slate presented by the Nominating Committee. The nominee receiving the plurality of the votes cast by those in attendance at the meeting will fill the position of Vice Chairperson for the remainder of the term of office.
- B. Should the Vice Chairperson be unable or unwilling to assume the position, then the Recording Officer will assume the position until the next regular meeting, where the first order of business will be the election of a new Chairperson and Vice Chairperson from the slate presented by the Nominating Committee. These new officers should remain in office for the remainder of the term of office.
- C. If all of the officers resign, then the Nominating Committee shall request that any commissioners interested in becoming officers notify the Committee of their intent. At the next regularly scheduled meeting, the Nominating Committee shall present the proposed slate of candidates to the Commission. Nominations for the candidates shall also be accepted by the Chairperson of the Nominating Committee at that meeting. Only commissioners who have served on the Commission for at least nine months may run for an office. Approval of the candidates will be passed by a majority vote of the currently seated commissioners.

## **ARTICLE V. MEETINGS**

**Section 1.** All meetings are open to the public. Regular meetings shall be held on the third Wednesday each month at 7:00 pm. Timely and proper notice shall be made in local publications of this meeting time and date. If this meeting place or time is changed, every effort will be made to notify the public as far ahead as possible.

**Section 2.** Interim meetings are held on the second Tuesday of each month at 7:00 pm or at the discretion of the committee chair. The primary purpose of the interim meetings shall be to conduct zoning committee business. Other committees may use this date.

**Section 3.** Special meetings may be called by the Chairperson, Vice Chairperson, or upon the written request of at least six WAC commissioners. The purpose of the meeting, date and location shall be stated in the call. Notice of a special meeting shall be given to each commissioner. Except in an emergency, at least three days written notice shall be given.

**Section 4.** A quorum shall consist of fifty percent plus one of the current membership roster.

**Section 5.** The order of business of Commission meetings shall be as follows:

- A. Roll Call

## WAC BY-LAWS 2018

- B. Minutes of the previous meetings
- C. Zoning applications
- D. Committee Reports
- E. Old Business
- F. New Business
- G. Announcements
- H. Adjournment

The Chairperson shall indicate on the agenda approximate time schedules for each part of the program. Regular meetings shall begin no earlier than 7:00 pm and end no later than 10:00 pm. Adjustments to this time schedule shall be at the discretion of the Chairperson; however, every effort should be made to conform to the written agenda.

**Section 6.** The Chairperson may recognize members of the public who wish to address the Commission concerning issues under discussion. Uniform time limits for such presentations shall be determined by the Chairperson.

**Section 7.** Commissioners may file written dissenting opinions with the Recording Officer for any WAC majority report or voting decision.

**Section 8.** Unless otherwise specified, meetings of the Commission shall be conducted according to the current edition of "Robert's Rules of Order."

**Section 9.** Commissioners are required to attend all meetings unless excused. (see Article III, Section 3, Paragraph C-1 & 2)

## ARTICLE VII. COMMITTEES

**Section 1.** Appointment of both standing and special committee members shall be made by the Chairperson, with the advisement of other officers.

**Section 2.** The members shall designate a Committee Chairperson from the members of the committee, subject to the approval of the Commission Chairperson.

**Section 3.** All standing committee positions must be assigned at a regular meeting following the annual election of commissioners.

**Section 4.** All committee members shall have equal voting rights within that committee.

**Section 5.** Official notification of all committee meetings shall be made to the members by the committee chairperson. Copies of all committee correspondence shall be forwarded to the Commission Chairperson and filed by the Recording Officer.

**Section 6.** The Chairperson of the Commission shall be an ex-officio member of all committees.

**Section 7.** The standing committees of the Westland Area Commission shall be:

1. By-Laws
2. Community Relations
3. Education
4. Nominating
5. Planning & Development
6. Public Health & Safety
7. Recreation & Parks
8. Zoning

The committees' duties are described below and may take on whatever other duties or tasks that are deemed appropriate by a majority commission vote.

1. The **By-Laws Committee** shall review and recommend any amendments to the By-Laws.
2. The **Community Relations Committee** shall act on behalf of the Westland Area Commission to forge partnerships with other community-based organizations, promote the activities of the Commission to the wider Westland community, and cooperate with all segments of the Westland Area including residents, organizations, associations, businesses and institutions. The Committee shall also recommend community-wide events, such as parades or special events to aid in the development of community identity.
3. The **Education Committee** shall work with the Southwestern City School District, Columbus Public School District, and any other training facility to ensure high quality educational opportunities for all residents. The Committee shall also review existing area employment and educational opportunities for residents of the area and recommend guidelines for the comprehensive short and long term planning concerning the same.
4. The **Nominating Committee** shall keep a list of potential candidates to recommend to the Commission in case a vacancy occurs.
5. The **Planning & Development Committee** shall review the existing area plan and recommend guidelines for the comprehensive short and long range planning of the Westland Area, including traffic, economic and physical aspects, monitor federal, state and local funding programs that affect the Westland Area; and develop means for citizen participation in planning which affects the Westland Area.
6. **Public Health & Safety Committee** shall monitor and review the adequacy and appropriateness of services provided by the City of Columbus and other public agencies in the Westland Area, including but not limited to: health, housing, natural resources, recreation, safety, and sanitation.

## WAC BY-LAWS 2018

The Committee shall also make recommendations for improvements in existing services.

7. **The Recreation & Parks Committee** shall ensure the provision of adequate recreation and open space for residents of the Westland Area. The Committee shall also make recommendations for improvements in existing facilities and parks, as well as for the addition of new facilities and parks. The Recreation & Parks committee shall also help to preserve the historic character and structures/monuments in the Westland Area.
8. The **Zoning Committee** shall monitor, review and make recommendations on all applications for re-zonings, variances, special permits, and appeals to the Board of Zoning Adjustment and other such matters regarding land-use and properties located within the boundaries of the Westland Area Commission. The Committee shall also negotiate with developers to ensure the most appropriate development.

**Section 8.** Special committees may be established for a specific purpose by the Chairperson, but must be reviewed by WAC every year.

**Section 9.** Individuals other than Commissioners may be appointed to serve on any committees.

**Section 10.** All findings of committees which result in proposed action or resolutions shall be submitted for consideration by the Commission at a regular or special meeting.

**Section 11.** Written dissenting opinions may be filed with the Recording Officer by Commissioners and shall be attached to a Committee's majority report.

## ARTICLE VIII. ELECTION

### SELECTION DATE:

The annual selection for members of the Westland Area Commission shall be held during the month of June, only if the number of petitions exceed the number of open seats.

The commission will make a public announcement on the open positions and how to obtain petitions no later than April 1.

Polling locations and times shall be announced no later than the June full commission meeting.

Candidates for selection to the Commission shall not be members of polling staff in the year in which their names shall appear on the ballot for election.

Each candidate to be placed on ballot must file a nomination petition, completed pursuant to the requirements set forth below, for candidacy with the Committee at least thirty calendar days prior to the selection date.

## WAC BY-LAWS 2018

Candidates in this non-partisan selection are not required to, in fact are encouraged NOT to declare any party affiliation.

**Section 1.** The election day shall be the last Saturday in June, only if the number of petitions exceed the number of open positions. If the number of petitioners do not exceed the open positions then the commissioners may appoint the petitioners by plurality vote at the next regularly scheduled commission meeting for the three year term. All elections, if held, shall be by secret ballot. Elections shall be determined by a plurality vote.

**Section 2.** Any person at least eighteen years old and who resides, works or owns property in the Westland Area shall be an elector. Electors need not be registered with the Franklin County Board of Elections.

**Section 3.** All nominations shall be by a petition as provided in the election rules. All candidates must be qualified to vote for themselves.

**Section 4.** There shall be an Election Board, consisting of up to seven commissioners not currently running for re-election. The Board shall:

- A. Provide for the appointment of necessary election officers.
- B. Devise the necessary forms, arrange for their reproduction and distribution.
- C. Provide the official ballots.
- D. Certify persons as candidates who have qualified.
- E. Hear and decide upon any complaints concerning the election or campaign.
- F. Tally the ballots and certify to the Westland Area Commission the winning candidates and the positions they will hold.
- G. Serve a term of one year, or until their successors are chosen and qualified.

**Section 5.** The Elections Board shall adopt election rules for governing the elections.

- A. Such rules shall be adopted by a majority vote of the Board.
- B. Such rules shall be in conformity with these By-Laws.
- C. Such rules shall not be changed in the thirty days after an election nor in the ninety days before an election.
- D. Any adoption or amendment of the Election Rules shall be presented to the Commission at the beginning of a regular meeting. Should the Commission not disapprove of them by the end of that meeting, they shall take effect.
- E. The Commission may amend the Election Rules without action by the Election Board in the same manner as a By-Law.

**Section 6.** Write-in candidates

- A. Write- in candidates are not permitted

WAC BY-LAWS 2018

**ARTICLE IX. ENDORSEMENTS**

**Section 1.** The Commission may not endorse any individual candidate for public office.

**Section 2.** If the membership desires to support specific issues which would benefit the Westland Area, the Commission may, by vote of the Commissioners present at the meeting and with an affirmative vote of two-thirds of the commissioners voting, decide to publicly support the issue(s). Dissenting voters may request voting results be included within the correspondence indicating the Commission's endorsements of the issue(s). Written dissenting opinions shall also be included.

**ARTICLE X. AMENDMENT OF BY-LAWS**

These by-laws, except as otherwise specified, may be amended at a regular or special meeting of the Commission by an affirmative vote of two-thirds of the commissioners present and voting, providing that the proposed amendment was submitted in writing at the previous regular meeting. In accordance with Chapter 3313 of the Columbus City Code, the approved amendment shall be filed immediately with the City Clerk. Such amendment shall take effect thirty days after publication in the City Bulletin.

I, Scott Taylor, Chairperson of the Westland Area Commission certify the foregoing to be a true and exact copy of the By-Laws of this Commission as adopted by the Westland Area Task force on the second day of November, 1990 and amended on the nineteenth day of June, 1991, and as amended on the twentieth day of October, 1992, and as amended on the seventeenth day of November, 1993, and as amended on the nineteenth day of January 1994, and as amended on the seventeenth day of January 1996, and as amended on the twenty-first day of August 1996, and as amended on the twenty-first day of June 2000, and as amended on the seventeenth day of January 2001, and as amended on the nineteenth day of January, 2011, and as amended on the twentieth of April, 2011, and amended on the 14<sup>th</sup> day of January 2015, and amended on the 18<sup>st</sup> day of April 2018 according to the records in our possession.

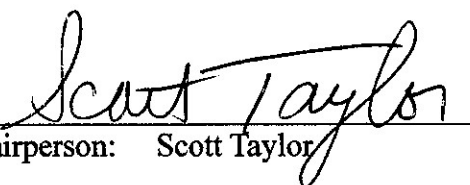
  
Chairperson: Scott Taylor

Attest: \_\_\_\_\_  
Recording Officer: Marian Hymer

**LIVINGSTON AVENUE AREA  
COMMISSION  
BYLAWS**



**PREAMBLE**

These Bylaws shall establish the order of procedures under which the LIVINGSTON AVENUE AREA COMMISSION (LAVA-C) shall execute those duties and functions set forth in and with the authority granted under Chapter 3109 of Columbus City Code. The commission shall not endorse any candidate for public office.

**Article I. GENERAL PROVISIONS**

Section 1. The name of this organization shall be the Livingston Avenue Area Commission, herein referred to as "Commission" or "LAVA-C".

Section 2. The boundaries of the Livingston Avenue Area Commission shall incorporate our 3111.03 boundaries:



West: West side of Lathrop Avenue and its extended line north of Livingston Avenue to Interstate 70; west side of Studer Avenue North: Interstate 70  
South: North side of Whittier Avenue; south side of Memory Ln; and the north side of Livingston Avenue  
East: Interstate 70

Section 3. These bylaws establish the procedure under which the Commission shall execute those duties and functions set forth in and with authority granted under chapters 3109 and 3111 of the Columbus City Codes (herein abbreviated as C.C.) and the Columbus City Charter sections 60 and 61.

Section 4. The Commission, and all of its bodies thereof, shall be governed by Robert's Rules of Order Newly Revised, except as inconsistent with these bylaws and except that:

- a. A quorum shall be two-thirds of the commissioners present.
- b. The voting shall be by roll call.
- c. All votes by the commission regarding matters of business and procedures other than those outlined specifically in these bylaws, shall be precedent for future legal or procedural matters. If there is no clear precedent or provision in the by-laws, there shall be a request set forth to the Columbus City Attorney for clarification and final decision.
- d. In the event of an even number of commissioners present at a meeting during a vote, the Commission President or presiding commissioner in the absence of the President shall abstain from voting. This will restore an odd number of voting commissioners.

Section 5. No Commission member shall represent the Commission in its official actions before any other public body or official, except as specifically authorized by the Commission. This shall not be construed as a restriction upon the right of the individual members to represent their own views before public or private bodies, whether

in agreement or disagreement with the official action of the Commission, provided they do not represent themselves as speaking for the Commission.

Section 6. No monies shall be expended or encumbered save pursuant to the Annual Budget.

- a. Within thirty (30) days of receipt of the draft annual agreement with the City of Columbus, the Treasurer and President shall propose the annual budget to the Commission. At the next regular meeting, the annual budget shall be adopted when approved by a majority of the Commission.
- b. Any monies received shall be deposited immediately by the Treasurer in an account at a financial institution designated by the current commissioners.
- c. All purchases must follow the guidelines allowed in current Columbus City Code for Commissioners.
- d. For purchases for Commission activities that are itemized in the approved annual budget, any Commissioner may request reimbursement by providing the Treasurer with a written, dated request explaining the purchase along with a paper copy of the receipt for the purchase. Permission to grant reimbursement may be given by the Treasurer.

Section 7. Election Committee: See **Article VI**.

Section 8. The Commission shall also facilitate communication, understanding, and cooperation among citizens, neighborhood groups, city officials and staff, and other stakeholders by performing those functions and duties set out in C.C. 3109.14.

## **Article II. MEMBERS**

Section 1. There shall be nine (9) members of the Commission.

- a. Nine (9) members, to be known as "Livingston Avenue Area Commissioners," shall be elected at-large.

Section 2. Members shall serve the following terms of office:

- a. A term of office for a Commissioner shall be three (3) years.

Section 3. Members shall take office at the Annual Meeting following the LAVA-C Election Committee official report as set forth in **Article IV**, Section 2.

- a. The annual meeting will be the second (2<sup>nd</sup>) Saturday in January.

Section 4. Vacancies shall be filled as follows:

- a. If a vacancy occurs on the Commission because of resignation, death, disqualification, or other means, the Secretary shall give public notice of the vacancy at least thirty (30) days before the date on which the Commission will vote to endorse a candidate to fill the vacancy. After providing an opportunity for persons interested in filling the vacancy to indicate their interest to the Commission, the Commission shall vote by individual, private public ballots to endorse a candidate to fill the vacated active term.

1. Notice of a vacancy shall be given in the agenda, and shall be made known to the public. The options may include but not be limited to: newspaper notice, flyers, television, radio, electronic media, community newspapers, and postings.
2. The Secretary shall send written notice of the candidate endorsed by the Commission to the Office of the Mayor and the Department of Development, pursuant to C.C. 3109.08.

Section 5. The Commissioners shall retain their residence within the Livingston Avenue Area Commission boundaries as set forth in **Article 1**, Section 2. from which they were elected. Commissioners can meet this residency requirement by owning, a business or religious institution in the LAVA-C boundaries. Failure to maintain their residence shall constitute resignation from the Commission. A Commissioner who has failed to maintain his/her residence in the community may petition the Commission to grant a waiver to this bylaw and the Commission may grant this waiver by a two-thirds vote. Notice of this waiver must be given in the meeting. If a waiver is granted, the Commissioner shall retain that seat only until the next Commission election.

Section 6. Three (3) absences from regular Commission meetings between annual meetings shall constitute voluntary resignation from the Commission. The

Chair of the Government and Legislation Committee shall notify, in writing or by electronic correspondence, a Commissioner who has been absent from two such meetings within fifteen (15) days of the second absence. Absent Commissioners may petition the President for approval of an absence from the Commission. This petition for approval of an absence as excusable shall be in writing or electronic form and submitted to the Chair of the Government and Legislation Committee thirty (30) calendar days prior to the absence or within ten (10) calendar days after the absence. Extenuating circumstances shall be considered and an absence may be excused by a two-thirds (2/3) vote of the Commissioners. Tardiness exceeding one half (1/2) hour from the start of a regular meeting shall be deemed an absence; tardiness of less than one half (1/2) hour from the start of a regular meeting shall be deemed attendance.

Section 7. The members of the Commission shall be approved and appointed by the Mayor of Columbus in accordance with C.C. 3109.08. The Secretary shall notify the Mayor and the Department of Development of all appointments, elections, and vacancies within thirty (30) days of such action.

- a. Should the Mayor neither approve nor disapprove within thirty (30) days of notification, the action shall be deemed approved as set forth in C.C 3109.12.
- b. A copy of each such notice shall be sent to the City Council (care of the City Clerk) and to the proper official with the Department of Development.
- c. New members of the Commission will attend orientation training as provided by the City of Columbus, or by the Commission, as soon as possible.

### **Article III. OFFICERS**

Section 1. The officers of the Commission shall be President, Vice President, Treasurer, and Secretary.

- a. The officers shall be elected by the Commission at the meeting preceding the annual meeting and shall take office at the annual meeting in January.
- b. All officers shall serve a term of three (3) years, or until their successors are elected and the process of certification is completed by the appropriate City of Columbus official.
- c. With the exception of the Executive Committee of which they are all a part, officers are allowed to chair a committee, but are not required to do so.

Section 2. The President shall:

- a. Chair all meetings of the Commission;
- b. Coordinate the actions of all officers and representatives of the Commission;
- c. Chair all public hearings called by the Commission;
- d. Select, supervise, direct or delegate any volunteers or staff hired by or assigned to the Commission;
- e.
- f. Represent or appoint a Commissioner to represent the Livingston Avenue Area Commission at City Council meetings and other meetings affecting the Livingston Avenue Area Commission;
- g. Appoint all chairpersons of standing committees.
- h. Approval of news stories and press releases pertaining to LAVA-C.

Section 3. The Vice President shall:

- a. Assist the President;
- b. Preside at meetings in the absence of the President;
- c. Assist the President in establishing and distributing the monthly agenda.
- d. The Vice President shall fill a vacancy in the office of President. A vacancy in any other position shall be filled in the same manner as the original selection process as set forth in **Article II**, Section-4.

Section 4. The Secretary shall:

- a. Keep and permanently file all resolutions considered by the Commission, as well as a record of all actions taken;
- b. Call the roll at each meeting of the Commission and record times of arrival and departure of Commissioners after roll has been taken or before the adjournment of the meeting;
- c. Correspond at the direction of the Commission;
- d. Keep on file all correspondence of the Commission;
- e. Provide copies of any Commission documents at a reasonable charge to any person requesting them;
- f. Notify the Mayor and the Department of Development of all appointments, elections, and vacancies within thirty (30) days of such action.
- g. Maintain all historic records of the Livingston Avenue Area Commission; maintain newsletter and photographs of the Livingston Avenue Area Commission.

Section 5. The Treasurer shall:

- a. Receive all monies and approve all payments for the Commission in accordance with **Article I**, Section 6;
- b. Prepare and present an Annual Budget, with the President, for the Commission in accordance with **Article I**, Section 6;
- c. Report on the financial condition of the Commission at each regular meeting;
- d. Submit a written report of the finances of the Commission at the Annual Meeting;
- e. Participate in the preparation of budget and expenditure of any grant monies; and
- f. Manage the distribution and administration of grant monies;
- g. Exercise all duties incident to the office of Treasurer, including compliance with all fiscal requirements within the memorandum of agreement with the city.
- h. Preside at meetings in the absence of the President and Vice President.

Section 6. The Commission may create additional officers or representatives. The Commission shall elect representatives with a majority vote of those commissioners present.

#### Article IV. MEETINGS

Section 1. The Commission shall hold a regular monthly meeting on the third (3<sup>rd</sup>) Tuesday of each month.

- a. A regular meeting may be cancelled or rescheduled by a two-thirds vote of the Commission at the regularly scheduled prior meeting of the Commission.

Section 2. The annual meeting in January shall be the meeting at which new Commissioners take office and annual reports from the committees are received.

- a. The first item of business for the meeting preceding the annual meeting will be the election of Commission officers.
- b. The election of officers shall be conducted by public ballot, the results of which shall be tallied immediately by the Election Committee Chairman, or a designated member, and announced to the Commission. A voice vote may be held if there are no contested offices.

Section 3. At least a five (5) day notice of all meetings shall be given. All meetings of the Commission shall be open to the public and comply with the Ohio open meeting law and the open meeting requirements pursuant to C.C. 121.01.

Section 4. The Commission shall consider no business unless introduced by a Commissioner or a committee of the Commission. No person shall speak during a Commission meeting except when recognized by the presiding officer. This can be subject to approval of the Commission by a majority vote.

- a. Allowance shall be made for public comment on any issue to be voted on by the Commission or a committee of the Commission. Each speaker shall be limited to three (3) minutes. This limit may be extended by a vote of the members present upon a motion of any Commissioner to do so. Time shall be allowed following each presentation for Commissioners to discuss and ask questions of the speaker. At his/her discretion, the presiding officer may limit the number of speakers on

each side of the issue to three (3). Such limitation shall be announced at the beginning of the public comments on that issue.

Section 5. Special meetings may be called by the President or by the Commission if five (5) of the Commissioners in office sign a petition to do so and submit it to the President.

- a. Any such petition shall specify the date, time, and place of the special meeting and shall include all business to be conducted at the meeting.
- b. No business shall be conducted at a special meeting unless explicitly included in the petition.

Section 6. At the direction of the Commission, by a majority vote, or a committee with the President's approval, a public hearing may be held.

- a. With the permission of a majority vote of the Commission, a public hearing may be held in conjunction with a Commission meeting.
- b. The Secretary, or other provided recording officer, shall keep a record of each public hearing.
- c. If a committee has called a public hearing, it shall provide the presiding officer and recording officer.
- d. At least a fifteen (15) day public notice shall be given for all public hearings unless extenuating circumstances warrant otherwise.

## Article V. COMMITTEES

Section 1. The President shall appoint Commissioners to the standing committees subject to approval by the Commission. The President shall consider requests for assignments from all Commissioners but is not bound by those requests. The standing committees are as follows: Public Safety; Zoning and Development Regulation; Recreation & Parks; Government & Legislation; Housing, Health, and Human Services; Education; Public Service; History and Community Relations; and Economic Development. The President shall appoint a Sergeant at Arms.

- a. The initial appointments shall be made at the meeting following the annual meeting.
- b. The President shall be ex officio a member of all committees and may elect to be a voting member of any committee at the meeting following the annual meeting.



- c. The President shall designate a Committee Chairman to convene each committee.
- d. Each committee may select other officers and adopt internal rules.
- e. All committees shall meet on a need to basis and are *required* to submit a written report, including attendance, at each general Commission meeting as well as reading that report at the meeting.
- f. A vacancy in a committee shall be filled in the manner of original selection.
- g. Each Commissioner must chair at least one (1) but no more than two (2) of the standing committees

Section 2. The Executive Committee shall meet annually or as needed and:

- a. Consist of the President, Vice President, Secretary, immediate past President (if still a Commissioner), and the Treasurer.
- b. Develop the annual budget
- c. Evaluate and plan the direction and scope of the Commission activities.

Section 3. The Chair of the Public Safety Committee shall:

- a. Conduct research, analysis, and make proposal recommendations on criminal justice issues and any city, state, or federal plans that affect the area;
- b. Encourage, support, conduct research, and make recommendations on criminal justice issues within the area;
- c. Research, monitor, and make recommendations on any federal, state, or local funds and grant monies that are available to implement criminal justice projects in the area;

- d. Conduct research, analysis, and make proposal recommendations on fire department issues and any city, state or federal plan that affects the area.
- e. The Committee's area of responsibility should include but is not limited to: the division of police, division of fire, division of communication, community relations between the fire and police departments, U.S. Justice Department, Drug Enforcement Administration, Ohio Department of Rehabilitation and Correction, adult and junior block programs, citizens on patrol, vehicle and control maintenance, and acting as a liaison to city public safety and to the Franklin County Sheriffs Department.

Section 4. The Zoning and Development Regulation Committee shall regularly receive, review, and make recommendations on all applications for rezoning, variances, and other zoning adjustments; all appeals; all requests for demolition permits, graphic permits, and special permits; and all applications for city historical designations pertaining to property wholly or partially within the Livingston Avenue Area Commission boundaries. The Committee shall also review existing zoning, building practices, and administrative procedures as well as make recommendations for proposed changes.

- a. The Zoning and Development Regulation Committee shall meet at least once per month.
- b. In the event that a recommendation on the zoning matter must be reported to a City Government Body before the full Commission can properly meet and take action upon it, the Zoning and Development Regulation Committee may proceed to make the recommendation on the Commission's behalf if prior to making such recommendation, the Committee obtains approval of the LAVA-C President and two (2) other Commissioners who are not members of the Zoning and Development Regulation Committee.
- c. In the event that the Commission receives from the City's Department of Regulation a demolition request for an accessory use building in a residential district from a private home owner; the Chairperson of the Zoning and Development Regulation Committee, the Chairperson of the Public Service Committee, the LAVA-C President, the Commissioners in the respective zone for which the demolition request is received and a resident of the Livingston Avenue Area who is not a Commissioner, **may** review the demolition request without a full meeting of the Commission. They shall review the proposed demolition; if all agree, the demolition is then deemed to be approved. If one disagrees, the matter shall be held over until the next regular LAVA-C meeting.
- d. The Zoning and Development Regulation Committee shall regularly receive, review with each applicant, and make recommendations to the

Commission on all applications for rezoning, variances, graphics and other zoning adjustment appeals, and special permits located wholly or partially in the area;

- e. The Zoning and Development Regulation Committee shall review, monitor, and approve all requests for demolitions. The decision of this committee on all such requests must be reported to the Commission at the next regularly scheduled meeting and is not final until that time. Upon a motion by any Commissioner, requests may be reconsidered by the entire Commission and approved by majority vote;

The Chair of the Zoning and Regulation Committee's area of responsibility shall include, but is not limited to: code enforcement and zoning, housing code violations, weed and grass violations, hazards and broken glass and trash on property, BET Environment health, board houses and garages, garbage and debris, off-street parking, signs and banners, inoperable vehicles, storage of RV's, boats, campers trailers and other vehicles, evictions and move out cleanups and act as a liaison to the Development Regulation Division.

- f. The Chair of the Zoning and Regulation Committee may select a Deputy Chair whose duties will be the same as that of the Chair.
- g. For all matters considering zoning and regulation, the Livingston Avenue Area Commission shall have two (2) Zones.
- h. **Zone West** shall be comprised of the Livingston Park Neighborhood Improvement Association and the Old Oaks Civic Association. The Livingston Park Neighborhood Improvement Association shall have the boundaries consisting of 1-70 to the north; the north side of Livingston Avenue to the south; the alley (Granger Alley) west of Ohio Avenue to the east; and the west side of Third Street to the West. The Old Oaks Civic Association shall have the boundaries consisting of 1-70 to the north; the north side of Livingston Avenue to the south; the alley (Lockbourne Rd.) east of Kimball Place to the east; and the alley (Granger Alley) west of Ohio Avenue to the west.

- i. **Zone East** shall be comprised of the Driving Park Civic Association and Hanford Village. The Driving Park Civic Association shall have the boundaries consisting of I-70 to the north; the north side of Whittier and the south side of Memory Lane to the south; 1-70 to the east; and the alley (Lockbourne Rd.) east of Kimball Place and the east side of Studer Avenue to the west. Hanford Village shall have the boundaries consisting of 1-70 to the north; the north side of Livingston Avenue to the south; 1-70 to the east; the east Side of Nelson Road to the west; and the area including the ,four properties Street off of Alum Creek Drive.
  
- k. All zoning matters, including all mentioned above, must be presented to the respective civic organizations or groups representing or comprised of either Zone West or Zone East. If a request for zoning or demolition falls within the boundaries of a zone and/or civic organization, a recommendation must be received by the commission from that group before it will be reviewed by the Livingston Avenue Area Commission. All persons or organizations making a request for zoning must attend Zone West, Zone East or civic association meeting and present their plans before the Commission will consider a request.

Section 6. The Chair of the Recreation and Parks Committee shall:

- a. Address, research, and make recommendations on recreation and parks issues in the area;
- b. Make recommendations to change city codes applicable to recreation and park issues;
- c. The area of responsibility of the Chair of Recreation and Parks Committee shall include, but not be limited to: recreation and park programs and facilities within LAVA-C; liaison to the city's Department of Recreation and Parks; inspection of grounds, benches, chairs, and equipment in the area.

Section 7. The Chair of the Government and Legislation  
Committee shall:

- a. Implement these bylaws and election rules as required;
- b. Research the effectiveness and applicability of these bylaws and make recommendations to the Commission for amendments to the bylaws;
- c. Conduct the orientation of new Commissioners;
- d. Coordinate the internal activities of the Commission as it relates to proper procedure and accountability.
- e. Conduct all elections; make recommendations to the President regarding candidates for vacancies; and educate residents on voting.

Section 8. The Chair of the Housing, Health, and Human Services Committee's area of responsibility shall include, but not be limited to: preservation of neighborhoods; provision of social service; consumer education courses to community; social services and programs; health care; disease control; ADAMH; health department (city and state).

Section 9. The Chair of the Education Committee's area of responsibility shall include, but not be limited to: promoting the quality of education in the LAVA-C area and making recommendations when appropriate. It shall ensure that area students receive the highest standard of education offered by the Columbus Public Schools. The Committee shall work with local school officials to institute measures pertaining to the safety of area students. It shall work with area Parent-Teacher Organizations on programs involving the community and the schools as well as other area organizations pertaining to educational programming. It shall interact with the Columbus City School Board. The Committee shall have knowledge of educational funding and its effect on local schools.

Section 10. The Chair of the Public Service Committee's area of responsibility shall include, but not be limited to: public and private construction; street maintenance; refuse collection; public utilities; traffic control; snow and ice removal; involvement with the Mid Ohio Regional Planning Commission and Columbus Compact.

Section 11. The Chair of the Economic Development Committee's area of responsibility shall include, but not be limited to: business concerns in the Livingston Avenue Area; economic planning in LAVA-C; Liaison to Economic Development Division; Historic Preservation Officer; forestry; Columbus chamber of Commerce; Columbus Urban Growth; and Columbus Compact.

Section 12. The Chair of the History and Community Relations Committee's area of responsibility shall include, but not be limited to: promoting mutual understanding and respect among all racial, religious, national, cultural, and ethnic groups within the Livingston Avenue Area Commission and suggesting ways to prevent discriminatory practices against such behavior. The Committee will work with community organizations to develop programs and educational campaigns devoted to the elimination of group prejudices, racial or neighborhood tensions, conduct research on the status and treatment of religious and ethnic groups in the LAVA-C area and enforce the City of Columbus Civil Rights Code.

The Committee will also actively participate in all such organizations dedicated to preserving the History of Columbus and actively solicit oral and written histories from residents past and present of the LAVA-C area.

Section 13. The Sergeant at Arms may be a non-Commissioner. The responsibility shall be to help maintain order and security at all meetings of the Commission.

Section 14. An Ad Hoc Committee may be established or dissolved by a majority vote of the Commission. Its size, powers, and duties shall be specified by the creating

resolution. Unless otherwise specified, the term of a special committee shall be one (1) year.

Section 15. All reports to the commission shall be delivered by the person chairing the committee (unless the committee directs otherwise). If a minority of a committee wishes to make a report, it may do so after the committee reports as an addition to the report.

Section 16. All committee meetings shall be open to the public.

Section 17. In the event that a matter overlaps the area of two or more committees, the President of the Commission shall have the authority to assign such issues to a specific standing committee, or charge two or more of the committees to work as a special combined committee for the issue.

## ARTICLE VI. ELECTIONS

Section 1. Elections will be held in the first week of November of each year. All elections shall be by secret ballot and determined by plurality vote. The exact date and location of the election is to be determined by the Election Committee.

a. The Election Committee shall have all necessary authority to conduct the election, including the counting of ballots.

b. Candidates for election to the Commission shall not be members of the Election Committee or polling staff in the years in which their names will appear upon the ballot for election.

Section 2. Any person who is eighteen years of age or older and has been a resident of the Commission area for a minimum of thirty (30) days prior to the election, shall be an elector. Electors need to be registered voters with the Franklin County Board of Elections.

Section 3. All nominations shall be by petition as provided in the Election Rules. All candidates must be qualified to vote for themselves and be a resident of the Livingston Avenue Area Commission community at least thirty (30) days prior to the election as set forth in the Election Rules, All candidates must provide a current typed resume covering at minimum the last five (5) years of work, professional and community activity at the time they receive deliver a petition.

Section 4. There shall be a LAVA-C Election Committee appointed by the President with the approval of the Commission. The Election Committee shall perform all duties set forth in the Election Rules. This Election Committee shall only be assembled in the years that there are elections. In election years the Election Committee is to be assembled ninety (90) days before the election and disbanded immediately after the election results are certified.

- a. Petitions shall be made available no later than sixty (60) days prior to the election. Petitions and typed resumes must be hard copies and hand delivered. Electronic mail and facsimiles will not be accepted.
- b. Petitions are to be circulated personally by the candidate(s).
- c. Each candidate must sign and date each petition page and hand deliver, with proof of identification, their petition and typed resume to the Election Committee no later than the final delivery date as determined by the Election Committee.
- d. The Election Committee may grant exception to the requirement that a petition be circulated personally by the candidate due to disability demonstrated by the circulator. This exception may be granted only upon written application submitted by the circulator to the Election Committee. If granted, a written statement to that effect must be issued by the Committee within seven (7) days after the Committee has



received the written application. A proxy shall be designated to collect the signatures.

- e. Each petition must be signed by at least fifteen (15) persons, aged 18 or over, and residing in the LAVA-C boundaries for at least thirty (30) days prior to the signing.
- f. There shall be a \$75.00 limit on campaign expenditures. A campaign expense is any applicable goods or services acquired primarily for campaign purposes. Each candidate must file a report of campaign expenditures within seven (7) calendar days after the election. There shall be no gifting of goods or services or in kind goods or services.
- g. Campaigning of any kind (including the posting of campaign materials, as well as any other activity that would amount to campaigning) within 100 feet of the polling place is prohibited.
- h. It is the candidate's responsibility to remove any campaign posters, fliers, etc. within 48 hours following Election Day.
- j. All polling records shall be placed in the custody of the Secretary of the Commission after the election is completed and retained in a secure place for three (3) years.
- k. The ballots shall be kept in a secure place until three (3) weeks after the election, at which time they may be destroyed under the supervision of the Election Committee.
- l. Election challenges must be presented in writing to the Election Committee on or by 5:00 p.m. on the seventh (7) day following the election.
- m. In the event of an election challenge, an immediate fact finding hearing will be held by the Election Committee for the purpose of receiving relevant testimony and receiving other evidence. The Election Committee shall not deliberate upon or make any determination in

regard to oral or other evidence received in the fact finding hearing. In a second hearing, which shall be open to the public, the Election Committee shall describe the evidence previously received, hear arguments relating to the evidence and make its decision. The decision of the Election Committee shall be taken to the full Commission. The decision of the Commission is final.

- n. Deadlines as they pertain to the election rules shall be strictly adhered to and shall be final in regard to the items to which they related. No person shall have the right to an extension of any election deadline.
- o. Violation of any rule shall result in the disqualification of the candidate.

Section 5. All candidates and electors must provide identification and proof of residence within the LAVA-C boundaries in which they intend to run or vote. Such identification may: be a valid driver's license, state-issued ID, other photo ID, Military ID or non-photo ID accompanied by another document to show residency within the LAVA-C boundaries. The Election Committee's determination of acceptable ID shall be final. Affidavits and other sworn statements, by themselves, shall never be sufficient.

A statement of the identification provided by electors, in instances where the sufficiency is uncertain, shall be written by the poll worker on the envelope in which the ballot is placed. The Election Committee shall determine the sufficiency of the identification before the envelope is opened. If it is the decision of the Election Committee that the identification is not sufficient, the envelope shall be retained unopened.

Successful candidates shall provide identification at the meeting of the Commission in which the election results are reported and approved. Should it be determined by vote of the Commission that the candidate has not established verification of

residency, the candidate receiving the next highest number of votes shall be declared the winner-

At any time prior to the day of the election, any Commissioner may dispute the residency of any candidate by so informing the Election Committee. In such case, the shall attempt to verify residency.

Each candidate shall have the right to have one challenger present when the votes are cast and when they are tabulated, provided such challenger has lived in the Livingston Avenue Area Commission community a minimum of thirty (30) days prior to the election.

Section 6. The LAVA-C Election Committee shall adopt Election Rules for governing the elections.

- a. Such rules shall be adopted by a majority vote of the-Election Committee.
- b. Such rules shall be in conformity with these bylaws.
- c. Such rules shall not be changed within the forty five (45) days before an election.
- d. Any adoption or amendment of the Election Rules shall be presented to the Commission at the beginning of a regularly scheduled meeting. Should the Commission not disapprove of them by the end of that meeting, they shall take effect.
- e. The Commission may amend the Election Rules without action by the Election Committee in the same manner as set forth in **Article VII**.

Section 7. Counting of the Ballots:

- a. The counting of the ballots shall be done by the Election Committee immediately following the conclusion of all voting.
- b. Candidates may have an observer present at the counting of the ballots.
- c. Results of the balloting shall be certified by the Election Committee to the Commission at the

next regularly scheduled meeting following the election and shall, thereafter, be certified by the Secretary of the Commission to the Appropriate City Official within thirty (30) days.

Section 8. Results:

- a. The candidate(s) receiving a plurality of votes cast shall be the winner(s).
- b. In the event of tie votes, the winner shall be decided by the majority of the Commission only after a recount of the ballots.

Section 9. Election Deadlines:

When a date is set as a deadline for the elections, and that date falls on a Sunday or a State (Ohio) or national holiday, then the deadline shall be extended to the next regular business day following the aforesaid weekend day or holiday. Deadlines as they pertain to the election rules shall be strictly adhered to and shall be final in regard to the items to which they are related. No person shall have the right to an extension of any election deadline.

Article VII. AMENDMENT OF BYLAWS

- Section 1. As permitted per C.C. 3109.13, these bylaws may be amended in part or in whole at any regularly scheduled meeting of the Commission by an affirmative vote of a two-thirds (2/3) majority of all Commission members provided that the amendments were submitted in writing at the previous regularly scheduled meeting. The Secretary shall file any approved amendments immediately after its adoption with the city clerk for publication in the City Bulletin, Such amendments shall take effect ten (10) days after such publication per C.C. 121.05.

For questions regarding any changes to the by-laws, please contact:

Michael Herman  
(614)945-4105  
mpjherman@gmail.com



# Design Guidelines for Small Cells, Wireless Support Structures, & Associated Infrastructure

First Edition

July 2018

Revised October 2018

# 1. Introduction

## 1.1 Background

Ohio House Bill 478 (“HB 478”), effective August 1, 2018, modifies the Ohio Revised Code concerning the regulation of wireless service deployed as small cell facilities within the municipal right-of-way.

The law’s intent is to promote the rapid deployment of small cell facilities within the right-of-way as part of the next generation of wireless service known as “5G”. Municipalities are obligated to grant or deny consent in a timely manner, with the recognition that a municipality may adopt design guidelines for the purpose of reviewing proposed small cell facilities. Although exempt from HB 478, small cell facilities proposed for poles owned by the Department of Public Utilities should follow the design guidelines to follow.

## 1.2 Purpose

The purpose of this document is to provide application procedures and design guidance for a number of potential buildout scenarios related to the deployment of small cell wireless facilities. The document will be used to:

- Provide uniformly applied criteria in a non-discriminatory fashion to all applicants;
- Support wireless service providers in the efficient deployment of small cell technology, to the benefit of residents, businesses, and visitors in the city of Columbus;
- Preserve and enhance the character of the city’s neighborhoods and commercial corridors by ensuring that small cell deployments are appropriate for their given context;
- Inform the siting, design, landscaping, screening, camouflaging, public art opportunities, and other pertinent factors in the installation of small cell facilities;
- Promote small cell deployment that is of a high quality of design;
- Provide flexibility to allow for future technological advancements in small cells to be taken into account; and
- Comply with, rather than conflict with or preempt, all applicable state and federal laws, including relevant FCC rulings.

### **1.3 Applicability**

Placement or modification of a small cell facility and/or wireless support structure shall comply with these design guidelines at the time the permit for installation or modification is approved and as amended from time to time. These design guidelines are in addition to other rules and regulations promulgated pursuant to Title 9 and the Department of Public Service's ROW regulations. Wireless support structures owned by the Department of Public Utilities are exempt from the provisions of HB 478. Nonetheless, small cell facilities proposed on wireless support structures owned by the Department of Public Utilities should follow the design guidelines to follow, unless otherwise agreed to by written agreement with the Department of Public Utilities.



## 2. Application Types

### Existing Wireless Support Structure Applications

#### **2.1 Type 1: New Small Cell Facility**

This type of application involves the installation of a new small cell facility on an existing structure within the right-of-way. This type of installation is referred to as collocation. This can occur on an existing utility pole, streetlight, traffic signal, or other existing pole. Attachments to poles owned by the Department of Public Utilities will require a separate agreement.

Standard Review Timeframe = 90 Days (Review timelines for attachment to poles owned by the Department of Public Utilities will comply with the pole attachment agreement.)

#### **2.2 Type 2: Substantial Modification of Small Cell Facility**

This type of application involves the modification of a small cell facility on an existing structure within the right-of-way that is considered “substantial” under federal law, defined as:

- (1) *It increases the height of the structure by more than 10% or more than ten feet, whichever is greater;*
  - (a) *Changes in height should be measured from the original support structure in cases where deployments are or will be separated horizontally, such as on buildings’ rooftops; in other circumstances, changes in height should be measured from the dimensions of the wireless support structure, inclusive of originally approved appurtenances and any modifications that were approved prior to the passage of the Spectrum Act.*
- (2) *It involves adding an appurtenance to the body of the wireless support structure that would protrude from the edge of the structure by more than six feet;*
- (3) *It involves installation of more than the standard number of new equipment cabinets for the technology involved, but not to exceed four cabinets; or, for wireless support structures in the public rights-of-way, it involves installation of any new equipment cabinets on the ground if there are no pre-existing ground cabinets associated with the structure, or else involves installation of ground cabinets that are more than 10% larger in height or overall volume than any other ground cabinets associated with the structure; and/or*
- (4) *It entails any excavation or deployment outside the current site.*

Standard Review Timeframe = 90 Days

#### **2.3 Type 3: Non-Substantial Modification of Small Cell Facility**

This type of application involves the modification of a new small cell facility on an existing structure within the right-of-way that is not considered “substantial” under federal law (see above definition of “substantial”). This type of install is referred to as an “eligible facility request”.

Standard Review Timeframe = 60 Days

## New Wireless Support Structure Application

### **2.4 Type 4: New Small Cell Facility**

This type of application involves the installation of a new small cell facility on a new wireless support structure within the right-of-way.

For Type 4 applications, the City of Columbus may request dedication of the new wireless support structure to the City of Columbus.

Standard Review Timeframe = 120 Days

## Replacement Wireless Support Structure Application

### **2.5 Type 5: New Small Cell Facility**

This type of application involves the installation of a new small cell facility on a new wireless support structure within the right-of-way that is replacing an existing wireless support structure at the same location. This may occur when the existing pole does not meet the needs of the applicant or a proposed small cell facility would not meet the design guidelines as provided by the City of Columbus.

For Type 5 applications, the City of Columbus may request dedication of the new wireless support structure to the City of Columbus.

Standard Review Timeframe = 120 Days

### 3. Application Requirements

#### 3.1 Pre-Application Meeting

The City strongly recommends a pre-submittal meeting to meet with potential applicants and discuss projects on a conceptual level. The meeting is intended to identify the correct application type and content requirements for any given project, and also to create an informal forum in which applicants and the City can discuss any concerns that should be addressed as soon as possible to avoid any unnecessary delays in the processing of an application and deployment of wireless facilities in the City.

An appointment is required for all pre-submittal meetings. City staff may establish regular hours in which appointments are available. City staff will endeavor to provide applicants with an appointment within approximately five (5) business days after receipt of a written or email request. Each meeting is generally limited to discussion of up to five potential projects, but applicants may request to discuss additional projects provided that the additional time required does not impact other applicants' ability to obtain an appointment.

#### 3.2 Tolling of Applications

The City will toll the timeline for review:

- (a) By mutual agreement between the applicant and the City,
- (b) In cases where the City determines the application is incomplete, or
- (c) When the number of applications is likely to result in difficulty processing them within the time limits noted under Application Types (Section 2) due to staff limitations. This would occur if the City received more than 90 applications within a consecutive 30 day period. For applications beyond the first 90, tolling shall be done as shown in Table 1 below.

| Population threshold | Application threshold | Applications for 1st tolling period (21 days) | Applications for 2nd tolling period (15 days) | Applications for 3rd tolling period (15 days) |
|----------------------|-----------------------|---|---|---|
| 100,001 or more      | 90                    | 91-120  | 121-150                                       | 151-180                                       |

Table 1 –  
Schedule of tolling of applications for small cell facility applications

### 3.3 Required Submittal Materials

Prior to submitting an application, the applicant is strongly recommended to complete a pre-application meeting. Once completed, an official application may be submitted, to include:

1. A permit application per the Department of Public Service's requirements, to include, at a minimum:
  - a. Name of company seeking permit
  - b. Point of contact
    - i. Mailing address
    - ii. Email address
    - iii. Phone number
  - c. Written documentation of agent designation
2. Application Type (see Section 2).
  - a. For Type 1 and Type 2 applications, the City of Columbus, in order to encourage collocation of small cell facilities by different carriers, may request an access agreement allowing other carriers to use the same wireless support structure where technically feasible. Demonstrative proof must be provided as to why collocation is not feasible.
  - b. For Type 4 and Type 5 applications, the City of Columbus may request dedication of the new wireless support structure to the City of Columbus.
3. Permit Fee of \$250 (2018).
  - a. Future permit fees are as follow: \$275 (August 2023), \$300 (August 2028)
  - b. Fees for attachment to poles owned by the Department of Public Utilities will comply with the pole attachment agreement.
4. Fully dimensioned site plan (prepared, sealed, stamped, and signed by a Professional Engineer licensed and registered by the State of Ohio).
  - a. Must depict any existing nearby wireless facilities (including from other carriers), with all existing transmission equipment identified; other improvements; the proposed facility, with all proposed transmission equipment and other improvements; and the boundaries of the area surrounding the proposed facility and any associated access or utility easements and setbacks.
5. Fully dimensioned elevation drawings (prepared, sealed, stamped, and signed by a Professional Engineer licensed and registered by the State of Ohio).
6. Structural Calculations (prepared, sealed, stamped, and signed by a Professional Engineer licensed and registered by the State of Ohio).
7. Color sample of existing pole (if applicable) with proposed paint color for the small cell facility.
8. Photo simulations from a least three reasonable line-of-site locations near the proposed project site.
  - a. The photo sims must be taken from the viewpoints of the greatest pedestrian or vehicular traffic. Angle of photo sim separation must be at 90 degrees or greater and provide a full profile depiction.
  - b. Photo sims should include all cabling, conduit, RF stickers, and identification stickers.
  - c. For existing poles that are leaning and slated for replacement, the photo sim should show the proposed upright pole.

- d. Photo sims should accurately reflect any proposed equipment offset from the pole
  - e. Include date of photo simulation
  - f. Photo sims should include all equipment proposed, including electric meter (if required), disconnect, and ground mounted equipment.
9. Equipment specifications:
- a. Manufacturer name and model number
  - b. Physical dimensions including, without limitation, height, width, depth, volume and weight with mounts and other necessary hardware;
  - c. Technical rendering of all external components, including enclosures and all attachment hardware; and
  - d. The ambient noise level generated from the equipment, if any at 3 feet away and 10 feet away.
10. Landscape plans (for sites with ground-mounted equipment or cabinets)
- a. Planting details
  - b. Plant species
  - c. Plant quantities
  - d. Spacing
  - e. Height/size at installation
  - f. Projected height/size at maturity
11. RF Compliance Affidavit
- a. Applicants must submit a sworn affidavit prepared and signed by an RF engineer with knowledge about the proposed project that affirms the proposed project will be compliant with all applicable governmental regulations in connection with human exposure to radiofrequency emissions. The affidavit must include:
    - i. All frequencies on which the equipment will operate;
    - ii. How many channels will be used on each frequency;
    - iii. The effective radiated power ("ERP") output level in measured watts; and
    - iv. The height above ground for the lowest point on the lowest transmitter. The required disclosures above must be included for all transmitters on the support structure, which includes without limitation existing collocated antennas and antennas used for wireless backhaul (such as microwave dish antenna or U/E relay).
12. A webmap with publicly downloadable GIS data displaying a current accounting of active small cell facility locations within the City of Columbus as of the application date (maintained in an ongoing fashion).

### **3.4 Incomplete Applications**

If the City determines during its review that the application is incomplete, the City will notify the applicant and suspend further review until the missing items are provided. Consistent with state and federal requirements, the City will toll the review timeline for incomplete applications. If the City determines the application is still incomplete after receipt of additional application materials, the City will toll the timeline again until the application is deemed complete

## 4. Siting

### 4.1 Existing Utility Pole Siting Preferences

The City of Columbus recognizes that every location is unique, however, the following list represents the City's preferences when siting small cells on existing City and non-City owned utility poles. The list is provided in order of preference, with number 1 being the most preferred.

1. Poles that have an existing small cell facility.
2. Guy stubs - Poles that do not have any electrical or communications; they simply provide a structural tie point for a guy wire for a neighboring pole
3. Poles with overhead secondary power conductors only (600 volts or less)
4. Primary electric poles with no attached equipment (with specific City approval for facilities owned by the Department of Public Utilities) Equipment includes transformers, reclosers, switches, capacitors, etc.)

### 4.2 General Restrictions on New Wood Poles

Collocation of small cell facilities on existing poles is a priority. Where a new pole is proposed at any location, the City reserves the right to require a metal pole rather than a wood pole based on the character of the proposed site location. In particular, new wood poles are strongly discouraged within the following areas:

1. Downtown District
2. East Franklinton District
3. University District
4. Historic Districts
  - a. Brewery District
  - b. German Village
  - c. Italian Village
  - d. Victorian Village
  - e. Other Historic Districts under the purview of the Historic Resources Commission
  - f. Other Historic Districts on the National Register of Historic Places
5. Areas with underground utilities

### 4.3 New Pole Siting Preferences

In all locations, the City reserves the right to require a metal pole rather than a wood pole based on the character of the proposed site location. New freestanding poles acting as wireless support structures for small cells should be located:

1. At the intersecting property line (parcel line) of two adjoining parcels wherever possible.
2. A minimum of 15 feet away from existing or planned street trees to avoid disturbing the root zone,
3. Spaced an equal distance between trees.
4. So as to not obstruct access to fire hydrants.
5. A minimum of 5 feet from driveways, entrances, or walkways.
6. Outside of the perpendicular extension of the primary street-facing wall plane for single unit and two unit residential buildings (see Figure 1 below)
7. At least 250 feet from other wireless support structures (proposed or existing), not including existing streetlights or utility poles.
8. Aligned within the same plane as existing trees, streetlights, utility poles, and other street furniture located in the amenity zone.
9. So as to not impede, obstruct, or hinder pedestrian, bicyclist, or vehicular travel
10. At least 2 feet from the travel way, edge line, face of curb, sidewalk, bike lane, or shared use path.
11. So as to adhere to existing neighborhood or district based streetscape improvement guidelines.
12. So as to not violate the Americans with Disabilities Act (ADA).
13. Outside of the clear vision triangle as determined by the Department of Public Service.
14. Away from storefront windows, when in a commercial areas, so as to not negatively impact said commercial establishment.
15. So as to not be positioned in front of an individually listed historic building, property or landmark (does not apply to buildings deemed historic as part of a historic district).

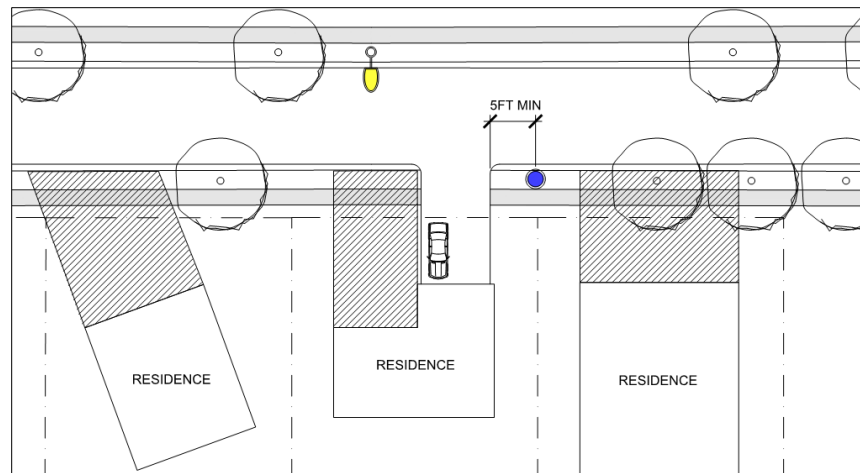

Figure 1 -

Proposed Small Cell Facility located on a new freestanding pole shown in blue. Hatched area shown is the perpendicular extension of the primary street-facing wall where new freestanding poles are discouraged.

#### **4.4 Collocation on Existing Poles:**

In order to reduce visual clutter, the City encourages the collocation of small cell facilities on existing poles where feasible. If the applicant chooses not to collocate when options appear available, a statement must be provided as to why collocation is not feasible.

#### **4.5 Collocation with other Wireless Carriers:**

As noted previously, the City of Columbus seeks to support wireless service providers in the efficient deployment of small cell technology, to the benefit of residents, businesses, and visitors in the city of Columbus. To that end, the City supports the collocation of small cell facilities by different carriers on the same wireless support structure wherever possible. If the applicant chooses to not collocate when options appear available, a statement must be provided as to why collocation is not feasible.

#### **4.6 Existing Small Cell Facility Designs:**

Type 2 and Type 3 applications (i.e. modifications to existing small cell facilities) are to be reviewed for consistency with the Design Guidelines. At the time of the application for modifications, the City may request reasonable, technically achievable modifications that are consistent with the Design Guidelines. Additionally, the City encourages the modification of existing non-compliant small cell facilities that would result in facilities that are more consistent with the Design Guidelines.



## 5. Design Guidelines

### 5.1 General Design Guidance:

1. **Concealment:** The design of any small cell facility should include concealment elements, including camouflaging and shrouding.
2. **Cabling:**
  - a. All cabling shall be hidden within conduit, shrouds, or by other concealment techniques.
  - b. For non-wood poles, underground cable or wires should transition directly into the pole base without any external junction box.
  - c. Excess cable shall not be spooled, coiled, or stored on the pole except within the approved shroud or cabinet
3. **Paint:** Antennas, brackets (mounting), equipment boxes (excluding ground mounted equipment), shrouds, meters, disconnects, conduits, and all other components of the small cell facility should be painted to match the color of the pole.
4. **Equipment Lighting:** Unless otherwise required for compliance with FAA or FCC regulations, the facility shall not include any permanently installed lights. Any lights associated with the electronic equipment shall be appropriately shielded from public view. This guideline is not meant to prohibit installations on streetlights or the installation of luminaires or additional street lighting on new poles when required by the City.
5. **Advertisement:** All manufacture equipment labels shall be removed, covered (i.e. by shrouding), or painted to match the pole and other equipment. Visibly depressed or indented manufacturer logos or names should be avoided, or filled in to match the equipment.
6. **Vaulting:** Installation in Underground Area: Where existing equipment and utilities are located underground, the City may at its discretion, require the installation of pad-mounted or vault-mounted equipment. Undergrounding of utilities is generally encouraged throughout the City.
7. **Height:**
  - a. The height of new wireless support structures, including the small cell facility itself, should not exceed 40 feet, except in areas where the predominant character is industrial in nature, in which case the height should not exceed 50 feet.
  - b. For an existing wireless support structure, the antenna and any associated shroud may be located at the top of the existing structure, but may not increase the height be more than 5 feet.
8. **Stickers:** Excessive stickers are discouraged. Where stickers are required by FCC regulation or for identification, the background of the sticker should match the color of the equipment, with black lettering, unless otherwise required by law.
  - a. **RF Warning Labels:** Utilize the smallest and lowest visibility RF warning stickers required by law, with the sticker placed as close to the antenna as possible.
    - i. For areas with nearby residential, place the sticker facing the street.
    - ii. Otherwise, place the sticker facing away from the street.
  - b. **Identification Label:** Identification of the small cell facility owner should be limited to a single sticker no larger than 4 inches by 6 inches. The background of the sticker should be the same color as the equipment, and should be placed on the bottom of

the equipment shroud if possible. Alternatively, the label may be placed on the equipment opposite the direction of vehicular travel on the adjacent roadway. The label should include:

- i. Carrier name
- ii. Location identification information
- iii. Emergency telephone number

## 5.2 Antenna Design Guidance:

### 1. Antennas:

- a. The antenna(s) associated with the first installation should be top-mounted and concealed within a radome that also conceals the cable connections, antenna mount and other hardware.
- b. Top-mounted antennas should be directly mounted to the pole or utilize a short extension that is full shrouded. Very tall extensions are generally not supported.
- c. Top-mounted antennas should be centered on the pole, not offset.
- d. Top-mounted antennas should be the same diameter of the pole at the point of attachment, and should appear as a seamless vertical extension of the pole.
- e. When a larger diameter antenna is required, the diameter should be no larger than 14 inches in diameter and include a smooth tapered shroud from the pole to the antenna.
- f. Top-mounted antennas should be no larger than 5 feet tall, including the antenna itself, radio head, mounting bracket, and all other hardware necessary for a complete installation.
- g. The antennas should be non-reflective and painted to match the pole (wireless support structure).
- h. Top-mounted antennas should not be installed on poles with primary electric wires. All antennas on primary electric poles shall be installed in the pole's communication space.
- i. The City may approve one side-mounted antenna per pole with the initial installation, in lieu of a top-mounted antenna, if, in the City's discretion, the side-mounted antenna would be more appropriate given the built environment, neighborhood character, and overall site appearance.
- j. Side-mounted antennas should conceal all cabling within the antenna arm extension.
- k. Side-mounted antennas should be installed parallel to the roadway.
- l. Antenna may not exceed 6 cubic feet in volume

2. **Wireless Backhaul:** The City generally discourages the use of microwave or other wireless backhaul that requires additional or separate antennas, with wired backhaul being preferred.

3. **GPS Antennas:** Where necessary for the operations of the small cell facility, GPS antennas should be built into the proposed primary antenna rather than added after the fact.

### 5.3 Electric Meter Design Guidance:

1. **Flat Rate:** Generally, utility-grade metering is preferred. However, flat rate electric service may be negotiated for installations where a “glass bubble” meter is impractical.
2. **Glass Bubble Meter:** If a glass bubble meter is proposed, the applicant should use a meter with a slim profile cabinet as shown in Figure 2,
3. **One Meter:** For poles with multiple wireless carriers, one electric meter (if present, or required) should serve all carriers, if feasible.



Figure 2 –

Slim profile electric meter on an existing wood pole. Note, however that it is not painted to match the pole per City of Columbus guidance.

4. **Disconnect Switches:** Place disconnect switches above or below the meter (when present) rather than to the side of the meter.

### 5.4 General Equipment Design Guidance:

1. **Number of Shrouds:** Generally, only one equipment shroud, containing all required small cell equipment, should be installed per pole. In cases where there are multiple wireless carriers using a pole, equipment shrouds should be the same width and color and stacked to present a unified design aesthetic.
2. **Sound:** Passive cooling (no noise generation) is preferred. If active cooling is required, the following guidelines apply for sound limits.
  - a. Goal of less than 30 decibels within 3 feet of any property line.
  - b. Maximum of 45 decibels within 3 feet of any residential property line or park
  - c. Maximum of 55 decibels within 10 feet of all other property lines
3. **Equipment, Cabling, & Conduit Attachments:**
  - a. For existing and proposed wood poles, all equipment, cabling, & conduit attachments should be flush with the pole.

- b. All wires, cables, and connections shall be located within the smallest diameter channel, conduit, u-guard, or shroud feasible, with a maximum diameter of 4", painted to match the pole.
- c. If existing pole limitations restrict this, pole replacement should be considered.
- d. If an offset from the pole is necessary for equipment, the shroud should include wings that fully conceal the offset.

### **5.5 Pole Mounted Equipment:**

1. When pole-mounted equipment is either permitted or required, all equipment other than the antenna(s), electric meter and disconnect switch must be concealed within an equipment shroud.
2. The equipment should be installed no lower than 15 feet above ground level.
3. The equipment shroud must be non-reflective and painted to match the existing pole.
4. It is preferred that equipment shrouds be mounted flush to the pole, subject to the pole owner's approval.
5. Standoff mounts are permitted for the equipment shroud, but may not exceed six (6") inches and must include metal flaps (or "wings") to conceal the space between the shroud and the pole.
5. Pole mounted equipment, including shrouds, should be long and narrow, with a target width equal to that of the pole.
6. Pole mounted equipment, including shrouds, should face away from nearby residential windows, where present.
7. The equipment shroud, electric meter, and disconnect should be placed on the same side of the pole and stacked as closely as possible along a common centerline.
8. Equipment may not exceed 28 cubic feet in volume

## 5.6 Ground Mounted Equipment Design Guidance:

1. Where ground mounted equipment or boxes are proposed the following apply:
  - a. **Suburban Commercial Areas** –
    - i. Ground mounted equipment should be 100% screened using evergreen plant material and shown on the landscape plan.
    - ii. The ground mounted equipment should be painted to blend in with the landscaped screening to the greatest extent possible.
  - b. **Urban Commercial Areas** –
    - i. Ground mounted equipment is discouraged, with vaulting encouraged for areas where utilities are located underground.
    - ii. Ground mounted equipment may be supportable if located in a box with a public art wrap (Columbus Art Commission review may be necessary) or camouflaged as part of a street furniture option or bus shelter. See Figure 3 for an example of each.

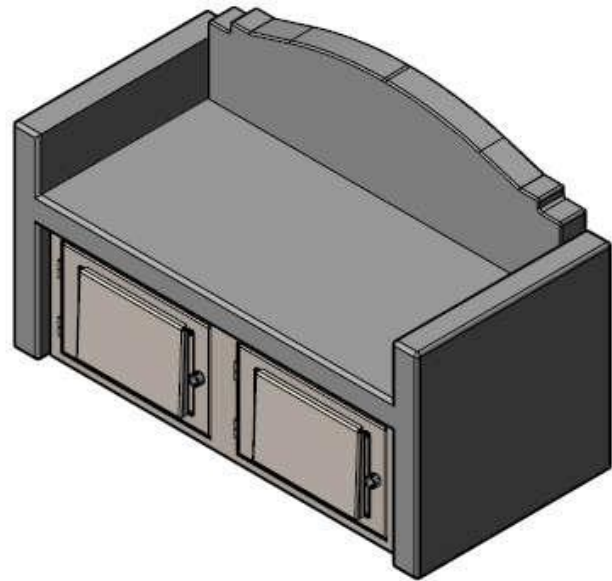

Figure 3 –

Example of a public art wrap on ground mounted equipment in an urban commercial area, and a bench with equipment cabinet below.

## 5.7 New Pole Design Guidance:

1. **New Poles with Blank Connections:** The City may require that for Type 4 and Type 5 applications, that the new pole include blank connections for City use such as cameras, food truck connections, wi-fi, wayfinding signage, or banners.
  - a. A minimum of 15% of the pole design structural capacity shall be reserved for future City installations.
2. **New Integrated & Standalone Metal Poles:**
  - a. Base equipment cabinet should be round to match diameter below.
  - b. Base equipment cabinet preferred diameter is 16 inches, with a maximum of 20 inches.
  - c. A decorative transition or base cover should be installed as a transition to the pole
  - d. Base equipment cabinet should be no taller than 5 feet in height.
  - e. Base equipment cabinet shall not have a continuous horizontal surface greater than 1.5 inches, to avoid accumulation of debris and litter,
  - f. Pole should create a cohesive architectural aesthetic

IFICATIONS

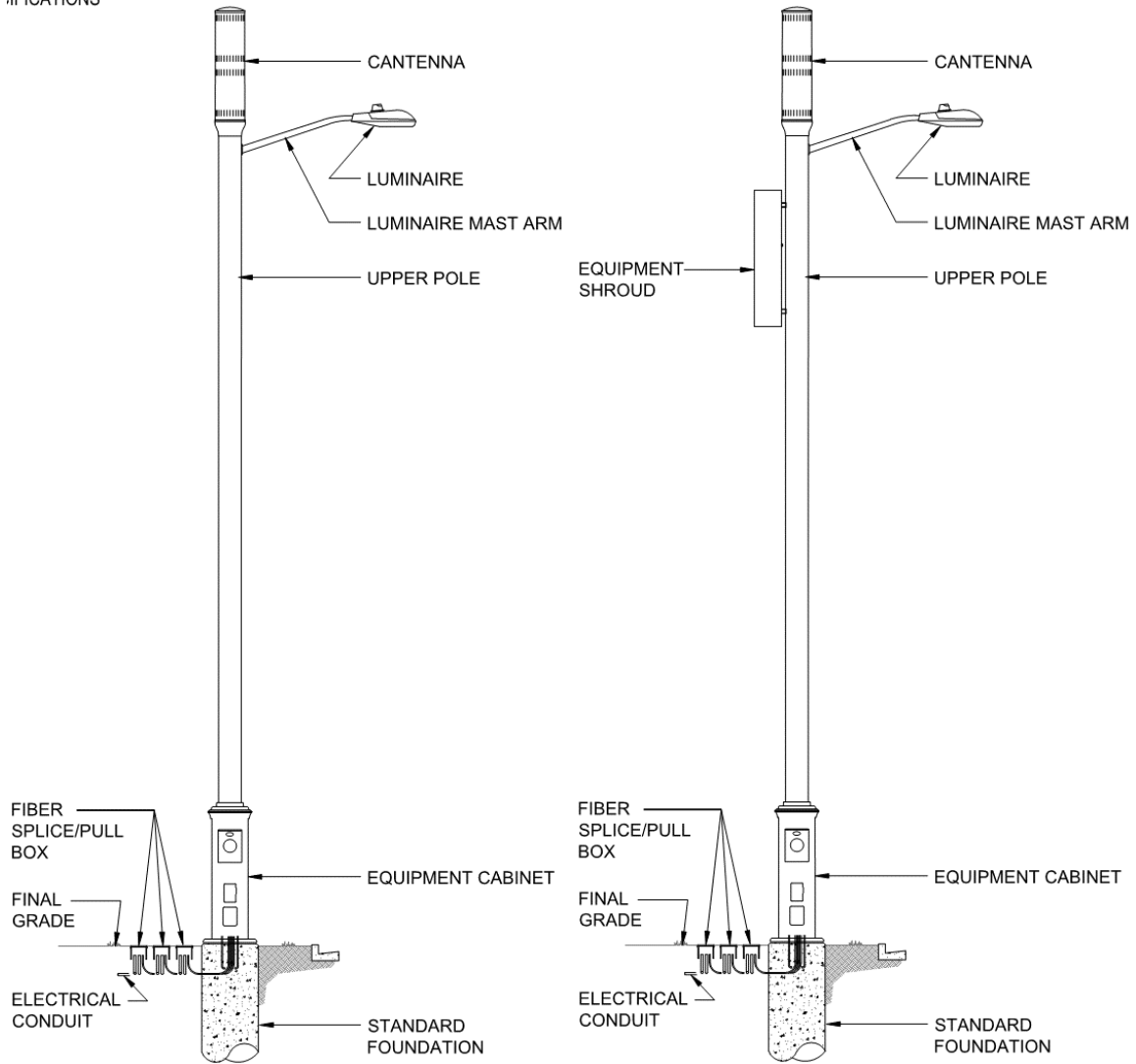

Figure 4 -

Examples of integrated street light with small cell facility

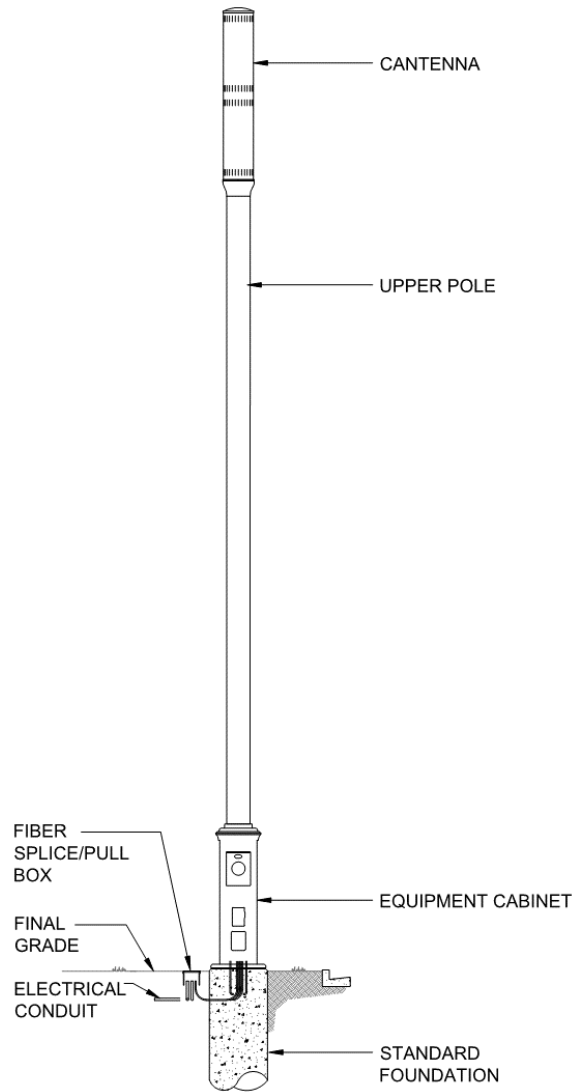

Figure 5 -  
Example of standalone small cell facility



**SUBJECT: WATER SERVICE TAP REQUIREMENTS**

Pursuant to the authority granted under Columbus City Codes Chapter 1101, the Director of the Department of Public Utilities hereby adopts, establishes, and publishes this rule and regulation to be effective at the earliest date allowed by law. This rule and regulation supersedes Division of Water Rule and Regulation 15-03, published February 7, 2015, in the *Columbus City Bulletin*, Columbus, Ohio. This rule and regulation is in addition to any established requirements that have not been superseded or rescinded by this or any previous act.

**APPLICATION:**

This regulation applies to every building, structure, or parcel of land requiring Water Service from the City of Columbus, Division of Water, including retail contract areas. This rule and regulation excludes Water Service in wholesale contract areas.

**DEFINITIONS:**

**Owner:** A person or entity whose name appears on the recorded deed of ownership with the pertinent County Auditor's Office.

**Water Service:** water supplied from a tap and service line connected to the City of Columbus, Division of Water distribution system.

**Private Water System:** A water system, owned and maintained by the property owner, extending from the tap, as defined by City Code, onto the premises to be served. It shall include the connection to the tap and all necessary piping and appurtenances before, after and including the meter for both the domestic and fire protection service lines.

**GENERAL REGULATION:**

The following are required to receive Water Service from the City of Columbus, Division of Water.

1. An application for Water Service shall be submitted for all new service connections or when a change occurs to an existing tap's service area. A plat or deed shall be submitted as part of the application process.
2. Except as permitted under subparagraphs (a), (b), (c), (d) or (e) below, Water Service from a single tap will only be permitted to buildings or structures located on a single parcel of land and which single parcel of land is identified by a single tax parcel identification number. Whenever any parcel of land is split or divided and the split or divided parcel(s) are assigned separate tax parcel identification numbers, such split or divided parcel(s) shall require a separate tap.

The foregoing limitations notwithstanding, Water Service may be provided by a single tap upon approval of the Director of the Department of Public Utilities under the following circumstances:

- (a) to real property comprised of residential units that are individually owned and are subject to a condominium declaration pursuant to Ohio R.C. Chapter 5311; or
- (b) to residential real property that is authorized by Columbus City Council as a Traditional Neighborhood Development (TND) or as a Planned Unit Development (PUD), and that is subject to a mandatory homeowners association that will be responsible for payment to the City of Columbus for water consumption and any other water-related charges, and for the maintenance of said real property's Private Water System. Authorization of residential real property as a TND or PUD by the legislative authority of a retail contract municipality may, subject to the approval of the Director of the Department of Public Utilities, be acceptable if such zoning is equivalent to the TND or PUD zoning for the City of Columbus, and a mandatory home owners association shall be responsible for payment to the City of Columbus for water consumption and any other water-related charges and for the maintenance of said real property's Private Water System, or
- (c) to real property that is authorized by Columbus City Council as a New Community District (NCD) under Ohio Revised Code Chapter 349, of which at least 50 percent of the total area is comprised of a former landfill or other brownfield site that is, and will in perpetuity remain, subject to oversight by the Ohio Environmental Protection Agency for any filling, grading, excavation, construction, or other related activities. The New Community Authority (NCA) associated with the NCD shall be responsible for payment to the City of Columbus for water consumption and any other water-related charges and for the maintenance of the NCD's Private Water System. The NCA shall notify each owner of property within the NCD of the NCA's responsibilities as related to water service. If the NCD or NCA should at any time cease to exist, construction of separate water service lines for each parcel will be required. If any parcel is removed from the NCD, construction of separate water service lines for such parcel will be required.
- (d)
  - i. to residential real properties that are part of an approved phased development, of which more than one phase has been constructed prior to the adoption of this rule and regulation, with previously constructed phase(s) receiving Water Service from a single tap and that the City of Columbus anticipated the subsequent phases would receive Water Service from a single tap, or
  - ii. to residential real properties constructed for the purpose of providing affordable senior or low-income housing, the owners of which are affiliated with a single non-profit organization recognized by the Director of the Department of Public Utilities as being established for the purpose of providing affordable senior or low-income housing, or
  - iii. to residential real properties owned by a single person or entity that, due to the annexation of one or more of the parcels, are located within different property tax districts and therefore cannot be combined into a single tax parcel, provided that, upon any a subsequent reclassification of property tax districts such that the properties can be combined, the parcels shall be combined within ninety (90) days of such reclassification.

However, the foregoing “i, ii, iii” only apply provided that the tap is sized sufficiently for all properties to be served by it, and further provided that all properties receiving Water Service from such tap are subject to binding covenants or other declarations running with the land containing terms as required by the Director of the Department of Public Utilities, including but not limited to the following provisions:

- a restriction on the transfer of the properties to different owners
- waterline cross easements for access, maintenance and repair
- common management of water and sewer accounts by a single owner
- compliance with applicable drinking water rules

The recorded instrument shall be recorded prior to plan approval, and shall not be modified or terminated without the prior written approval of the Director of the Department of Public Utilities. If the terms of the recorded instrument are not met, each property will be subject to termination of Water Service, and construction of separate water service lines for each parcel will be required; or

(e) to any tract of land that includes a building or structure that is listed on the National Register of Historic Places or the Columbus Register of Historic Properties, and the Water Service to said property as a result of practical difficulties owing to the historic character of the property and its registration cannot be separated readily, and the owner of all such divided historic parcels of land, buildings or structures have executed binding covenants or other declarations running with the land for the benefit of the City that shall obligate all property owners jointly and severally for the payment of the water consumption and any other water-related charges to the City and maintenance of said real property’s Private Water System.

3. Unless approved by the Director of the Department of Public Utilities, a Private Water System shall not cross through a public right of way, public access easement, or water main easement.
4. There shall be only one (1) City owned meter per tap; and one (1) tap per City owned meter and all outlets shall be after the meter.

APPROVED: RC Westerfield  
RICHARD C. WESTERFIELD, P.E., Ph.D.  
ADMINISTRATOR  
DIVISION OF WATER

10/30/18  
DATE

APPROVED: Tracie Davies by AMT  
TRACIE DAVIES  
DIRECTOR  
DEPARTMENT OF PUBLIC UTILITIES

10.30.2018  
DATE

Published in City Bulletin: \_\_\_\_\_

RULES AND REGULATIONS 18-03  
Division of Sewerage and Drainage  
Department of Public Utilities

October 23, 2018

Subject: Local Limits for the Control of Discharges of Wastewater to the Columbus Sewerage System

Pursuant to the authority granted under Columbus City Codes Section §1145.11 and §1145.23, the Director of Public Utilities hereby adopts, establishes and publishes this rule. This rule shall become effective at the earliest time allowed by law. This rule specifically replaces and supersedes the previous Director's Regulation promulgated October 1, 2013 titled "LOCAL LIMITS FOR THE CONTROL OF DISCHARGES OF WASTEWATER TO THE COLUMBUS SEWERAGE SYSTEM."

This rule and regulation is in addition to any established requirements that have not been superseded or rescinded by this or any previous act.

Purpose: The purpose of local limits is to restrict the discharge of pollutants which could harm the Columbus sewerage system if discharged in excess.

Table 1 represents the maximum concentrations of specific pollutants ("Local Limits") for wastewater discharges to the POTW by any Users. Dilution of any wastewater discharge for the purpose of satisfying these requirements is a violation of this Regulation and the Sewer Use Ordinance, Columbus City Code Chapter 1145.

On or after the Effective Date, no person shall discharge or cause to be discharged wastewaters with concentrations that exceed the following local limits:

| <b>TABLE 1</b>   | <b>Maximum Composite Sample</b> | <b>Maximum Daily Mass</b> |
|------------------|---------------------------------|---------------------------|
| <b>Pollutant</b> | <b>ug/L</b>                     | <b>Grams/day</b>          |
| Arsenic          | 1,000                           | 38                        |
| Cadmium          | 500                             | 19                        |
| Chromium, Total  | 20,000                          | 757                       |
| Copper           | 2,700                           | 102                       |
| Cyanide          | 5,000                           | 189                       |
| Hydrocarbon FOG  | 200,000                         | 7573                      |
| Lead             | 4,000                           | 151                       |
| Mercury          | 20                              | 1                         |
| Nickel           | 5,000                           | 189                       |
| Selenium         | 10,000                          | 379                       |
| Silver           | 3,000                           | 114                       |
| Zinc             | 5,500                           | 209                       |

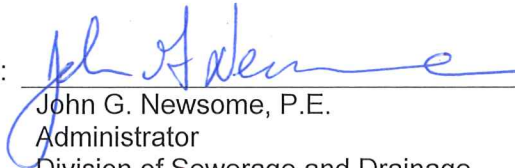

Customer Service | Telephone (614) 645-8276 | Fax (614) 645-0222 | TDD (614) 645-7188  
Power Division | 3500 Indianola Avenue | Columbus, OH 43214 | Telephone (614) 645-8371 | Fax (614) 645-7830  
Sewerage and Drainage | 1250 Fairwood Avenue | Columbus OH 43206 | Telephone (614) 645-7175 | Fax (614) 645-3801  
Water Administration | 910 Dublin Road Columbus OH | 43215 | Telephone (614) 645-7020 | Fax (614) 645-3993  
Director's Office | 910 Dublin Road | Columbus OH 43215 | Telephone (614) 645-6141 | Fax (614) 645-8019  
columbus.gov

Approved:  \_\_\_\_\_ 10-27-18  
John G. Newsome, P.E.  
Administrator  
Division of Sewerage and Drainage (Date)

Approved:  \_\_\_\_\_ 11/1/18  
Tracie Davies  
Director  
Department of Public Utilities (Date)

Published in the City Bulletin: \_\_\_\_\_  
(Date)

\_\_\_\_\_  
(Date)



John R. Kasich, Governor  
 Mary Taylor, Lt. Governor  
 Craig W. Butler, Director

September 18, 2018

Re: NPDES Permit No.: 4PF00000\*PD  
 Pretreatment Program modification - Local  
 Industrial Discharge Limitations

Mayor and Council, City of Columbus  
 90 East Broad Street  
 Columbus, OH, 43215

Ladies and Gentlemen:

Pursuant to the requirements of Chapter 6111 of the Ohio Revised Code and Ohio Administrative Code 3745-3-03, the application submitted by the City of Columbus for approval of modification to its Publicly Owned Treatment Works (POTW) Pretreatment Program is hereby approved.

**Purpose, Abbreviated:** Local Industrial Discharge Limitations

**Purpose, Expanded:** The City of Columbus has proposed to remove the beryllium local limit and continue all other existing local limits. The industrial discharge limitations applicable to both Jackson Pike and Southerly wastewater treatment plant are the summarized below:

| Pollutants            | Existing Limit (mg/L) | Proposed Limit (mg/L) |
|-----------------------|-----------------------|-----------------------|
| Arsenic               | 1.0                   | 1.0                   |
| Beryllium             | Below Detection       | None                  |
| Cadmium               | 0.5                   | 0.5                   |
| Chromium              | 20                    | 20                    |
| Chromium (hexavalent) | None                  | None                  |
| Copper                | 2.7                   | 2.7                   |
| Cyanide               | 5                     | 5                     |
| Lead                  | 4                     | 4                     |
| Mercury               | 0.02                  | 0.02                  |
| Molybdenum            | None                  | None                  |
| Nickel                | 5                     | 5                     |
| Selenium              | 10                    | 10                    |
| Silver                | 3                     | 3                     |
| Zinc                  | 5.5                   | 5.5                   |

This limit is technically based in order to prevent pass-through water quality violations, contamination of sludge, and the inhibition of biological wastewater treatment processes.

This approval is conditioned on the City of Columbus's compliance with terms of and the commitments made in this modification and the final application for the approval; and with all applicable provisions of the state and federal law governing POTW pretreatment programs. The

City of Columbus' NPDES permit will be modified to incorporate terms of and commitments made in the final application.

You are hereby notified that this action of the Director is final and may be appealed to the Environmental Review Appeals Commission pursuant to Section 3745.04 of the Ohio Revised Code. The appeal must be in writing and set forth the action complained of and the grounds upon which the appeal is based. The appeal must be filed with the Commission within thirty (30) days after notice of the Director's action. The appeal must be accompanied by a filing fee of \$70.00, made payable to "Ohio Treasurer Josh Mandel", which the Commission, in its discretion, may reduce if by affidavit you demonstrate that payment of the full amount of the fee would cause extreme hardship. Notice of the filing of the appeal shall be filed with the Director within three (3) days of filing with the Commission. Ohio EPA requests that a copy of the appeal be served upon the Ohio Attorney General's Office, Environmental Enforcement Section. An appeal may be filed with the Environmental Review Appeals Commission at the following address:

Environmental Review Appeals Commission  
30 East Broad Street, 4<sup>th</sup> floor  
Columbus, OH 43215

Sincerely,

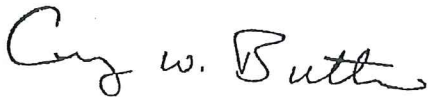

Craig W. Butler  
Director

CWB/kep

**CERTIFIED MAIL**

cc: Dax Blake, Div. Sewerage and Drainage  
Jeffery Bettacchi, Div. Sewerage and Drainage  
Greg Sanders, CDO  
Phoebe Low, CDO  
Franklin County Public Health  
Journal Room  
Pretreatment File

**..Title**

**Notice/Advertisement Title:** September 2018 Update Period List of Registered Active Legislative Agents

**Contact Name:** James Lewis

**Contact Telephone Number:** (614) 724-4690

**Contact Email Address:** jalewis@columbus.gov

**..Body**

All Legislative Agents -

**Agent name (status):** Lewis W. Adkins, Jr. (Active)

**Clients:** CGI Technologies and Solutions, Inc.; GPD Group; Jacobs; Kokosing Construction Company, Inc.; Miles McClellan Construction Company; Resource International

**Agent name (status):** Cresha Auck (Active)

**Clients:** < No records found >

**Agent name (status):** Trudy Bartley (Active)

**Clients:** The Ohio State University; The Ohio State Wexner Medical Center

**Agent name (status):** Phillip Bayt (Active)

**Clients:** The Columbus Downtown Development Corporation

**Agent name (status):** Barbara Benham (Active)

**Clients:** Huntington Bancshares Incorporated

**Agent name (status):** Greg Bennett (Active)

**Clients:** American Cancer Society Cancer Action Network Inc ; Community Shelter Board ; Rev1 Ventures; U.S. Green Building Council

**Agent name (status):** Krista Bistline (Active)

**Clients:** < No records found >

**Agent name (status):** Alex Boehnke (Active)

**Clients:** < No records found >

**Agent name (status):** Darnita Bradley (Active)

**Clients:** < No records found >

**Agent name (status):** Jeffrey Brown (Active)

**Clients:** 1000 S Front LLC ; 1354 Ida Avenue LLC ; 14th Hole Development LLC ; 14th Hole Development LLC ; 1774 LLC ; 3540 WDG LLC ; 907 West Broad Real Estate LLC; ABR Holdings; AED Enterprises LLC; AI Limited ; American Commerce Insurance Co.; Andrew Losinske; Anthony Thomas Company; Arlington Properties ; Avalon Acquisition LLC ; Avenue Partners LLC ; BB Building Company of Western Ohio LLC ; BB&S Laser Systems, LLC; BLK Properties Inc.; Banyon Park Resources LLC ; Bear Creek Capital Company; Benjie Lewis; Black Wilshire Ridgely LLC ; Brick Investments Corp.; Bristol Group Inc.; Brookside Country Club LLC ; Brookwood Construction; Buckeye Express Wash ; Buckeye Terminals ; Buckeye Wayfaring Hostel; Burroughs Property Holdings, LLC; Burwell Investments LLC ; Byers Chevrolet; Byers Mazda; CA Ventures ; CB Busch Office Portfolio; CVCO, Inc.; Canini & Associates ; Cap City Hotel LLC; Capital Park Family Health Center Corp.; Capital Towing & Recovery ; Casto Edwards Hayden Run Ltd; Casto Organization;



Catherine Adams ; Cavin Carmell; Cela Real Estate Investment LLC; Charles J. Kistler ; Charlies Corner II; Chemlawn Commercial LLC ; Chris Sherman ; Church of Scientology; Clintonville Academy; Colony Capital Inc; Columbus Bituminous Concrete Corp; Columbus Country Club ; Columbus Foundation Properties, LLC; Columbus Regional Airport Authority ; Comfy Couch Company; Community Development for All People; Conrad's College Gifts; Continental Bell, Ltd.; Continental Builders Inc.; Continental Real Estate Companies; Continental Real Estate Companies ; Cooper Lakes II,LLC; Core Resources, Inc.; Core Resources, Inc.; Cornerstone Capital Partners Corporation; Costco Wholesale; Cup O' Joe Holdings, Inc.; DGJL,LLC; DMI Metals ; Dan Tobin Buick GMC ; David Woods ; Dennis Koon ; Don Compton ; Don M. Casto Organization; Donald W. Kelley & Associates; Donley Concrete Cutting Co; Doug Tenenbaum; Dr. Chris Smiley; Duke Realty Corporation; E.V. Bishoff Company; Edwards Communities Development Company; Edwards Companies ; Elford Development ; Energy Management LLC ; Envisionpoint LLC; Epcon Communities Inc.; Estate of George C. Smith ; Estate of Rebecca Larkins ; Evergreen Cemetery ; Evergreen Ventures, LLC; FST Logistics; First Community Church of Columbus Ohio; Flexicom LLC; Four String Brewing Co; Furniture Bank of Central Ohio; Garry Rowe; Germain Lexus of Easton; Giant Eagle Inc.; Giuseppe Holdings LLC ; Gray Gables Realty Inc.; Grismer Tire ; Hanks Holdings Ltd ; Hayden Development LLC; Home Designs, Ltd.; Homewood Corp; Indus Companies ; Info Depot LLC; Integrated Partners Development ; Integration Resources Inc; Integrity Cycles; J. Johnson Investments LLC ; JC Roofing Supply ; JDS Acquisitions LLC; JVL Properties ; Jack and Ruth Strader; Joe Dirt Central Ohio LLC ; Jupiter Ohio Inc; Just 1 LLC ; Kevin Mullins; Kristin Boggs & Adam Ward ; LAMS UNITED PROPERTIES, LLC; LDK Land, LLC; Lahoti Properties, Ltd.; Lawyers Property Development Corporation; Lifestyle Communities; Lifestyle Communities ; Limited Brands; Lockbourne DG, LLC; Long & Wilcox LLC; Low Country Imports; Lurie Family LP; Lutheran Social Services ; Lutheran Social Services of Central Ohio; M/I Homes of Central Ohio, LLC ; Marathon Petroleum Company LLC; Marathon Petroleum Company LP; Marillian LLC; Marillian LLC ; Masjid as Sahaba; Matt Vekasy ; Menard, Inc.; Metropolitan Holdings LLC ; Metropolitan Partners; Michael Sabo, Sharon Sabo, David Sabo Sandra Sabo; Morso Holding Co; Mosaica Education Inc.; Mouth of Wilson LLC ; New Village Communities LLC ; Nicholas J. Ford ; Northstar Realty; Northstar Realty; Northwest Property Management ; Oakstone Academy; Ohio Hospital for Psychiatry ; Ohio Mulch; Ohio Mulch Supply Incorporated; Olympic Beach Acquisitions LLC; Orange Barrel Media LLC ; PAR Electrical Contractors Inc.; Parson One LLC ; Pat Grabill & Company; Penn National Gaming, Inc.; Pet Palace Enterprises LLC ; PetSuites of America, Inc.; Peter & Jill Dole; Phil Fulton; Platinum Lodging LLC ; Plaza Properties ; Provident Partners ; Provident United Inc; Public Storage Inc; RPMD LLC; Rajesh Lahoti; Ramseyer Presbyterian Church ; Ray Wilson Homes ; Redwood Acquisition LLC ; Ricart Properties Ltd.; Robbins Realty ; Robert Lytle; Ron & Guy Blauser ; Ross Development ; Ruben-Lorek LLC ; S&Y Property Inc; SV Inc.; Sam Kahwach; Sarepta Therapeutics ; Schottenstein Real Estate Group ; Sean & Barbara Brogan; Snyder-Barker Investment LLC ; Steve & Linda Genteline; Steve Jefferis; Stock Development Company LLC; TDH Investments ; TH Midwest Inc.; TOW Ltd.; Tansky's Sawmill Toyota, Inc.; Ted Lawson; The Ellis Company, Ltd.; The Ellis Company, Ltd.; The Kroger Co.; The Limited ; The Linden Cleve Theater; The NRP Group LLC; The New Albany Company; The Ohio State University ; The Ohio State University ; The Stonehenge Company; The Witness Group; Thomas C. Smith; Thorntons Inc.; Today's Child Montessori School; Val Boehm; Village Communities; W2S3, Inc.; Wagenbrenner Company; Wal-Mart Stores Inc.; Wallick Asset Management LLC; Weber Holdings South LLC ; Westwood Cabinetry & Millwork LLC ; Will-Seff Properties ; Wilmont Consultants; Workspace Arlington; ZBP Properties; deMonye's Greenhouse, Inc.

**Agent name (status):** William Byers (Active)

**Clients:** Alvis, Inc.; American Cancer Society Cancer Action Network Inc ; Battelle Memorial Institute ; Community Shelter Board; Danny Wimmer Presents, LLC ; Equality Ohio; Homeport; Lutheran Social Services of Central Ohio; Nationwide Children's Hospital; Ohio Quarter Horse Association ; Print Syndicate, Inc.; RadiOhio; Rev1 Ventures; The Columbus Crew; U.S. Green Building Council

**Agent name (status):** Louis Capobianco (Active)

**Clients:** Anthem Blue Cross & Blue Shield; CGI; Crown Castle; Ofo; RA Consultants; RAMA Consulting Group; The Efficiency Network

**Agent name (status):** Juan Cespedes (Active)

**Clients:** < No records found >

**Agent name (status):** Derrick Clay (Active)

**Clients:** 3SG Technology Co-Sourcing; AT&T Ohio; American Traffic Solutions; Borrer Properties; CT Consultants; Classic Productions; Coleman Spohn Corporation; David and Mary Ann Pemberton; Direct Energy Services LLC; Dynotec, Inc.; Emergitech; First Energy Solutions; Garth's Auctions, Inc.; Human Services Advocates; Loud Hailer Incorporated; M.I.A. Hookah Cafe LLC; Mangos LLC; Marsy's Law; Medical Mutual; Midnight Hookah Lounge ; Ricart Automotive, Inc.; Sahara Shisha LLC; Sutphen Corporation; TMT Consolidated LLC; The Success Group; TowLogic Incorporated; Veolia Water North America/Indiana Region

**Agent name (status):** Michael Coleman (Active)

**Clients:** Columbus Apartment Association; Columbus Regional Airport Authority; Connect Realty; DLZ Corporation; Franklin County Convention Authority; Kaufman Development; Ohio Health Corporation; Schiff Capital Group; Stonehenge Company; The Columbus Downtown Development Corporation; Wagenbrenner Development

**Agent name (status):** Laura Comek (Active)

**Clients:** 3700 Parsons LLC; 503 S. Front Street LP; 503 South Front Street LP; 800 Frank Road LLC; B&I Group, LLC; Charles and Cynthia Herndon, Trs. ; Ciminello's Inc.; City of Columbus - Dept. of Development; Columbus Housing Partnership; Columbus Limestone; Columbus Regional Airport Authority; Columbus Urban Growth; DCR Commercial Development, LLC; Electronic Classroom of Tomorrow; Englefield Oil Co.; Giuseppe Gioffre, et al. (Gioffre Family); Gowdy Partners III, LLC; Homewood Corporation; ISL Communities; Inland Products, Inc.; Insituform Technologies, Inc.; Joe Ciminello; Jonathan R. Pavey, Su-Trustee; Kurtz Bros. Central Ohio; Lincoln Theatre Association; MCCORKLE SOARING EAGLES LLC; MI Homes; Mr. and Mrs. John Bocook; Palmetto Construction Services LLC; Pulte Homes; R.W. Setterlin Building Company; Rockford Homes; ShadoArt, Inc.; ShadoArt, Inc.; Shelly Materials, Inc.; TechCenter South Development Company; The Anchor Companies; The Hutton Company; Transfuels, LLC; WXZ Retail Group; Wagenbrenner Development Company; William R. Alsnauer & Karen E. Asmus-Alsnauer

**Agent name (status):** Deanna Cook (Active)

**Clients:** < No records found >

**Agent name (status):** Steven Cuckler (Active)

**Clients:** < No records found >

**Agent name (status):** Shawna Davis (Active)

**Clients:** < No records found >

**Agent name (status):** Glen Dugger (Active)

**Clients:** 1000 S Front LLC ; 1354 Ida Avenue LLC ; 14th Hole Development LLC; 3540 WDG LLC; 3728 Agler Road LLC; 907 West Broad Real Estate LLC; ABL Group Ltd.; ABR Holdings ; AED Enterprises LLC; AI Limited ; American Commerce Insurance Co.; Andrew Losinske; Anthony Thomas Company ; Arlington Properties; Avalon Acquisition LLC ; Avenue Partners LLC; BB Building Company of Western Ohio LLC; BB&S Laser Systems, LLC; BLK Properties Inc; Banyon Park Resources LLC; Bear Creek Capital Company ; Benjie Lewis; Black Wilshire Ridgely LLC; Brick Investments Corp.; Bristol Group Inc.; Brookside Country Club LLC; Brookwood Construction; Buckeye Express Wash; Buckeye Terminals ; Buckeye Wayfaring Hostel; Burroughs Property Holdings LLC; Burwell Investments LLC; Byers Chevrolet ; Byers Mazda ; CA Ventures; CB Busch Office Portfolio; CVCO, Inc.; Canini & Associates ; Canini & Associates ; Cap City Hotel LLC; Capital Park Family Health Center Corp.; Capital Towing & Recovery; Casto Edwards Hayden Run Ltd; Casto Organization; Catherine Adams ; Cavin Carmell; Cela Real Estate Investment LLC; Charles J. Kistler ; Charlies Corner II; Chemlawn Commercial LLC ; Chris Sherman; Church of Scientology; Clintonville Academy; Colony Capital Inc; Columbus Bituminus Concrete Corp; Columbus Country Club ; Columbus Foundation Properties LLC; Columbus Regional Airport Authority ; Comfy Couch Company; Community Development for All People; Conrad's College Gifts; Continental Bell, Ltd.; Continental Builders Inc.; Continental Real Estate Companies; Continental Real Estate Companies ; Cooper Lakes II, LLC; Core Resources, Inc.; Core Resources, Inc.; Cornerstone Capital Partners Corporation; Costco Wholesale; Cup O' Joe Holdings, Inc.; DGJL, LLC; DMI Metals ; Dan Tobin Buick GMC ; David Woods; Dennis Koon; Don Compton ; Don M. Casto Organization; Donald W. Kelley & Associates; Donley Concrete Cutting Co; Doug Tenenbaum; Dr. Chris Smiley; Duke Realty Corporation; E.V. Bishoff Company ; Edwards

Communities Development Company; Edwards Companies ; Elford Development ; Energy Management LLC; Envisionpoint LLC; Epcon Communities Inc.; Erickson Retirement Communities, Inc.; Estate of George C. Smith ; Estate of Rebecca Larkins ; Evergreen Cemetery ; Evergreen Ventures, LLC; FST Logistics ; First Community Church of Columbus Ohio; Flexicom LLC; Four String Brewing Co; Furniture Bank of Central Ohio; Garry Rowe; Germain Lexus of Easton; Giant Eagle Inc.; Giuseppe Holdings LLC; Gray Gables Realty Inc.; Grismer Tire ; Hanks Holdings Ltd; Hayden Development LLC; Home Designs, Ltd.; Homewood Corp; Indus Companies ; Info Depot LLC; Integrated Partners Development; Integration Resources Inc; Integrity Cycles; J. Johnson Investments LLC ; JC Roofing Supply ; JDS Acquisitions LLC; JVL Properties ; Jack and Ruth Strader; Joe Dirt Central Ohio LLC; Jupiter Ohio Inc; Just 1 LLC; Kevin Mullins; Kristin Boggs & Adam Ward; LAMS UNITED PROPERTIES, LLC; LDK Land, LLC; Lahoti Properties Ltd.; Lawyers Property Development Corporation; Lifestyle Communities ; Limited Brands; Lockbourne DG LLC; Long & Wilcox LLC; Low Country Imports; Lurie Family LP; Lutheran Social Services; Lutheran Social Services of Central Ohio; M/I Homes of Central Ohio, LLC ; Marathon Petroleum Company LLC; Marathon Petroleum Company LP; Marillian LLC; Masjid as Sahaba; Matt Vekasy ; Menard, Inc.; Metropolitan Holdings LLC ; Metropolitan Partners; Michael Sabo, Sharon Sabo, David Sabo, Sandra Sabo; Morso Holding Co; Mosaica Education Inc.; Mouth of Wilson LLC; New Village Communities LLC ; Nicholas J. Ford ; Northstar Realty; Northstar Realty; Northwest Property Management; Oakstone Academy; Ohio Hospital for Psychiatry ; Ohio Mulch; Ohio Mulch Supply Incorporated; Olympic Beach Acquisitions LLC; Orange Barrel Media LLC ; PAR Electrical Contractors Inc.; Parson One LLC ; Pat Grabill & Company; Penn National Gaming, Inc.; Pet Palace Enterprises LLC; PetSuites of America Inc; Peter & Jill Dole; Phil Fulton; Platinum Lodging LLC ; Plaza Properties ; Provident Partners ; Provident United Inc; Public Storage Inc; RPMD, LLC; Rajesh Lahoti; Ramseyer Presbyterian Church; Ray Wilson Homes ; Redwood Acquisition LLC; Ricart Properties Ltd.; Robbins Realty; Robert Lytle ; Ron & Guy Blauser ; Ross Development ; Ruben-Lorek LLC ; S&Y Property Inc; SV Inc; Sam Kahwach; Sarepta Therapeutics; Schottenstein Real Estate Group; Sean & Barbara Brogan; Snyder-Barker Investment LLC ; Steve & Linda Genteline; Steve Jefferis; Stock Development Company LLC; TDH Investments ; TH Midwest Inc.; TOW Ltd.; Tansky's Sawmill Toyota, Inc.; Ted Lawson; The Ellis Company, Ltd.; The Ellis Company, Ltd.; The Kroger Co.; The Limited ; The Linden Cleve Theater; The NRP Group LLC; The New Albany Company ; The Ohio State University; The Ohio State University; The Stonehenge Company; The Witness Group; Thomas C. Smith; Thorntons Inc.; Today's Child Montessori School; Val Boehm; Village Communities; W2S3 Inc.; Wagbrenner Company; Wal-Mart Stores Inc.; Wallick Asset Management LLC; Weber Holdings South LLC; Westwood Cabinetry & Millwork LLC ; Will-Seff Properties; Wilmont Consultants; Workspace Arlington; ZBP Properties; deMonye's Greenhouse, Inc.

**Agent name (status):** ROB Eshenbaugh (Active)

**Clients:** AMAZON.COM, INC; Marathon Petroleum Corporation & its Subsidiaries ; VERIZON COMMUNICATIONS & AFFILIATES

**Agent name (status):** Patricia Eshman (Active)

**Clients:** < No records found >

**Agent name (status):** Keith Ferrell (Active)

**Clients:** Fraternal Order of Police Capital City Lodge 9

**Agent name (status):** Anthonio Fiore (Active)

**Clients:** < No records found >

**Agent name (status):** Adam Flatto (Active)

**Clients:** The Georgetown Company

**Agent name (status):** Bradley Frick (Active)

**Clients:** Dublin Taxi

**Agent name (status):** Kevin Futryk (Active)

**Clients:** KidSMILES Pediatric Dental Clinic; Ohio Living Corporate; Outdoor Advertising Association of Ohio

**Agent name (status):** Lou Gentile (Active)

**Clients:** BIRD RIDES, Inc.

**Agent name (status):** Joanne Goldhand (Active)

**Clients:** Columbus Regional Airport

**Agent name (status):** Erik Greathouse (Active)

**Clients:** AMG Peterbilt; RICHARD L. BOWEN + ASSOCIATES INC.; Woolpert

**Agent name (status):** James Groner (Active)

**Clients:** Battelle Memorial Institute ; Bernard Radio LLC; Crew Soccer Stadium Limited Liability Company; Lutheran Social Services of Central Ohio; Mount Carmel Health System

**Agent name (status):** Holly Gross (Active)

**Clients:** Columbus Chamber of Commerce

**Agent name (status):** DANIEL HILSON (Active)

**Clients:** The John Gore Organization

**Agent name (status):** Deb Hackathorn (Active)

**Clients:** TMH Solutions

**Agent name (status):** Thomas L. Hart (Active)

**Clients:** Adept Properties, c/o Bowser Morner; Boys & Girls Clubs; Central Ohio Restaurant Association; Columbus KTC; Compass Homes; Epcon Communities; Harmony Development Group LLC; Landmark Properties; Pulte Homes of Ohio LLC; R M McFadyen Holdings Limited; Scene 75; Shannon D&B LLC; Summit Realty Investors LLC

**Agent name (status):** Brandon Hatton (Active)

**Clients:** Airbnb, Inc.

**Agent name (status):** David Hodge (Active)

**Clients:** Burwell Investments LLC; CA Ventures; Caldwell Automotive; CarCorp, Inc.; Center State Enterprises; DHOD, Inc.; DNC Hamilton Crossing LLC; DeVore Real Estate; Dennis Koon; Evergreen Cemetery Association; Fairway Realty; Furniture Bank of Central Ohio; HP Land Development, Ltd.; Hamilton Crossing LLC; Hondros Family of Companies; JTW Investment Group LLC; Katz Tires; Lane and Tuttle LLC; M/I Homes of Central Ohio, LLC; Metropolitan Holdings; Orange Barrel Media; Oxford Circle LLC; Oxide Real Estate; Parsons Parc II LLC; Preferred Living; Preferred Living Acquisitions; Sam Kahwach; Swensons Drive-In Restaurants; Target Corp.; The Casto Organization; The Kroger Co.; The New Albany Company LLC; Thorntons, Inc.; Wayfaring Buckeye Hostel

**Agent name (status):** Larry James (Active)

**Clients:** Boys & Girls Clubs of Columbus; Campus Partners; Columbus Limestone; Columbus Regional Airport Authority; Columbus Urban Growth; Homeport by Columbus Housing Partnership; Insituform Technologies, Inc.; Joseph Skilken & Company; King Arts Complex; King Lincoln District Plan; Kokosing Construction Company, Inc.; Lincoln Theatre Association; Shelly Materials, Inc.; TechCenter South Development Company; The Anchor Companies

**Agent name (status):** Belinda Jones (Active)

**Clients:** American Heart Association

**Agent name (status):** Matthew Kallner (Active)

**Clients:** Alliance Data Systems; COSI Columbus; Centric Consulting, LLC; Children's Hospital; LimitedBrands; Lyft; NetJets Inc.; Rave Mobile Safety; Snyder Barker Investments; The Georgetown Company

**Agent name (status):** Jeffrey Kasler (Active)

**Clients:** < No records found >

**Agent name (status):** Thomas Katzenmeyer (Active)

**Clients:** Greater Columbus Arts Council

**Agent name (status):** Caryn Kaufman (Active)

**Clients:** CKE Management, LLC; GourMED, LLC

**Agent name (status):** John Kennedy (Active)

**Clients:** Cambridge Health Care Development Corporation; Columbus Museum of Art; EP Ferris; Franklin Park Conservatory; Greater Columbus Arts Council; HNTB Engineering; Kaufman Development; L Brands; Lifestyles Communities; New Albany Company; Verizon; wagenbremmer Development

**Agent name (status):** John Anthony Kington (Active)

**Clients:** Citynet, LLC; IGS Ventures; Randy Belden

**Agent name (status):** Connie Klema (Active)

**Clients:** Anne Boninsegna; Borrer Properties; Charles Arida; Christen Corey; DAY COMPANIES; Emily Noble; Kerr St Place ; Kerr Street Place; Land Use Plan Ltd; Mark Heatwole; New Victorians; Nicholas Savko & Sons, Inc. Properties; Urban Restorations LLC; Victor Investment Ltd; Vision Development Inc.

**Agent name (status):** Adam Knowlden (Active)

**Clients:** Test

**Agent name (status):** Jason Koma (Active)

**Clients:** < No records found >

**Agent name (status):** Matt Koppitch (Active)

**Clients:** 82 Price Ave Owner, LLC; Renovate America; Southeast, Inc.

**Agent name (status):** Kurt Leib (Active)

**Clients:** Amazon Corporate LLC; Marathon Petroleum Corporation; Verizon Communications and Affiliates

**Agent name (status):** Gregory Lestini (Active)

**Clients:** Ameresco; Consider Biking; Grubb & Ellis Realty Investors; Hexion; Human Service Chamber of Franklin County; Southeast, Inc; The Tomko Company; Verizon Wireless; Whirlpool Corporation

**Agent name (status):** Annie Marsico (Active)

**Clients:** The Ohio State University Wexner Medical Center

**Agent name (status):** George McCue (Active)

**Clients:** United HealthCare Services, Inc.

**Agent name (status):** Michael Mentel (Active)

**Clients:** 182 SC LLC; Citynet, LLC; First LeVeque, LLC; IGS Ventures, Inc. ; Jerome Solove Development, Inc.; Northwest Neighbors ; Randy Belden

**Agent name (status):** Sean Mentel (Active)

**Clients:** Aetna Inc.; AutoReturn; Borrer Properties; Brown and Caldwell; C.T.L. Engineering Inc.; CT Consultants; CompManagement Health Systems, Inc.; EmNet; GPD Group; H. R. Gray & Associates, Inc; HAVA Partners; Halliday Technologies; Infor (US), Inc.; Kokosing Construction Company, Inc; Lifestyle Communities LTD; Manheim Ohio Auto Auction; Medical Mutual of Ohio; Orange Barrel Media; RGM Real Estate, LLC; Rehrig Pacific Company; Scioto Downs Inc.; Skilken Development LLC; Stavroff Ventures IV; Uber Technologies, Inc.

**Agent name (status):** Angela Mingo (Active)

**Clients:** < No records found >

**Agent name (status):** Craig Moncrief (Active)

**Clients:** < No records found >

**Agent name (status):** Karen Morrison (Active)

**Clients:** < No records found >

**Agent name (status):** Rebecca Mott (Active)

**Clients:** 398 S Central LLC; Ancient Order of Hibernians in America; Cedar Square LLC; Custom Built Homes, Inc.; Donald W. Kelley and Associates, Inc.; Fairfield Commercial Properties LLC; Hinely, Aubrey L.; Holiday Inn; Holiday Inn; Laurel Health Care; Liberty Place, LLC; Marshall Acquisitions; N.P. Limited; Roof to Road; United Dairy Farmers; Wagenbrenner Company, The

**Agent name (status):** Josh Motzer (Active)

**Clients:** CenturyLink, Inc.

**Agent name (status):** Timothy Nagy (Active)

**Clients:** CKE Management, LLC; GourMED, LLC

**Agent name (status):** Stephen Nielson (Active)

**Clients:** Alvis, Inc. ; Columbus Crew SC; Homeport; Lutheran Social Services of Central Ohio; Nationwide Children's Hospital, Inc.

**Agent name (status):** Dannette Palmore (Active)

**Clients:** Chester Engineers; Hatch Chester, Ltd.

**Agent name (status):** Leah Pappas Porner (Active)

**Clients:** Continental Tire the Americas, LLC & Subsidiaries ; Rumpke Consolidated Companies ; Teradata

**Agent name (status):** David Paragas (Active)

**Clients:** Borrer Properties; Ernst & Young LLP; Exelon Generation Company; Mobilitie Management, LLC; Ruscilli Construction Co., Inc.

**Agent name (status):** David Perry (Active)

**Clients:** 1199 Franklin Investments, LLC; 1341 Norton Partners LLC; 1872 South Third Street LLC; 313 Livingston 2010 LLC; 328 St. Clair, LLC; 3332 W Henderson Road LLC; 49 E Third, LLC; 5151, LLC; 810 Grandview LLC; 876 S Front LLC; Adcon Developments, LLC; Airport Land, LLC; Ann S. Ford Trust; Antares Park at Polaris LLC; Architectural Alliance; AutoZone, Inc.; Avenue Partners; Blankenship Family LLC; Blue Chip Development Group, LLC; Borrer Properties; Breco Properties; Brent L. Beatty; Buckeye Express Wash LLC; Buckeye Real Estate; CAD Capital LLC; CASTO; CCBI Homes ; CCBI Homes (Paul Cugini); Case Road Holdings, Ltd./River Highlands Developme; Centex Homes, Ohio Division; Certified Oil Company; Ciminello's, Inc; Claypool Electric; Claypool Electric (Chris Claypool) ; Cliffel and Cliffel, LLC; Cole Tar LLC; Columbus Storage Developers, LLC; Community Housing Network ; Core Properties, LLC; Core Resources, Inc.; Covelli Enterprises; Crestpoint Development Company; Cugini Enterprises, LLC; DACOH Holdings LLC; DCH Architects, LLC; Dalicandro; David Cattee; David Kozar; Dennis and Cathy Hecker; Dewcar LLC; Donald W. Kelley & Associates, Inc. ; Douglas - CBP, LLC; Dublin Building Systems; Easton Hotel Holdings LLC; Ed Mershad; Egan Ryan Funeral Service; Eleventh Avenue Properties; Elford Development Ltd; Epic Development Group LLC; Epic Realty of Ohio I, LLC; Fairfax Properties, LLC; Fairway Realty; Frankbank, LLC; GDT, LLC; Gallas Zadeh Development LLC; George Kanellopoulos; George and Laura Kanellopoulos; Grandview 1341 LLC; Greenlawn Realty Company; Gregg Allwine; Hamme and West Enterprises LTD c/o George Bellows; Harrison West Ventures LLC; Hi-Five Development Services; Historic Dennison Hotel LLC; Home Designs, Ltd.; Homeport Ohio; Hometeam Properties, LLC; Hometown Development Co., LLC; Indus Hotels ; JDS So Cal LTD; Jeffrey New Day LLC; Jerry Lee; Joe Ciminello; KAC Management, Inc; KM22 Investments LLC; Kalamata, LLC; Kinnear Road Redevelopment LLC; LS Development Systems, LLC; Laurel Healthcare; Luteg High, LLC; Lykens Companies; Marous Brothers Construction; Michael Amicon c/o Rockbridge Capital; Michael DiCarlo; Michael McDermott; Midnight Blue LLC; Mohammed Alwazan; Moo Moo Car Wash LLC; Mount Properties, LLC; Mulberry Development; NAPA Holdings, LLC; NP Limited; NP/FG, LLC; OSU Properties LLC; PETSuites; Park Property Investment,s LLC; Paul Cugini ; Peak Property Group LLC; Performance

Automotive Network; Perry Street, LLC; Pickett Companies; Place Properties; Polaris 91, LLC ; Portrait Homes Columbus, LLC; Portrait Homes Columbus, LLC; RCG Ventures; Radha Corp.; Randall Hall; Resource Property Investments, LLC; Right Property Group; Riverwood Partners; Robert C. Talbott; Roof to Road LLC; Royal Tallow, Ltd; SB ECP Broadview, LLC; SB ECP Broadview, LLC; Saint Charles Preparatory School; Scioto Retirement Community, Inc; Scott Pickett; Scott T Mackey; Signature Millshop; Suncole LLC; Terry Mathews; Terry O'Keefe; The Bigler Company; The NRP Group LLC; The Pagura Company; The Richard J. Conie Company; The WODA Group LLC; The Wagenbrenner Company; Trabue Road Townhomes LLC; Tulsu Hotels, LLC; UHaul Company of Ohio; Urban Revival, LLC; VanTrust Real Estate; Victorian Heritage Homes LLC; Villas of Scioto, Inc; WODA Group, LLC; WTOL, LLC; Weinland Park Properties LLC; Weinland Senior LLC; Wills Creek Capital Management LLC; Wills Creek Capital Management LLC; Wills Group, LLC; Winham Investments LLC; Woda Cooper Companies, Inc.; Wood Companies; Yaw And Delahi Aguekum

**Agent name (status):** Lloyd Pierre-Louis (Active)

**Clients:** Charles Street Investment Partners

**Agent name (status):** Donald Plank (Active)

**Clients:** 1341 Norton Partners, LLC; 1374 King Avenue LLC; 313 Livingston 2010 LLC; 3342 Henderson Rd LLC; 398 S Central LLC; 876 S. Front LLC; Albany Place Investment LTD; Ancient Order of Hibernians in America; Antares Park at Polaris LLC; Beatty, Brent L.; Bloom, Don; Buckeye Real Estate; CAD Capital LLC; Cedar Square LLC; Certified Oil Company; Core Resources, Inc.; Covelli Enterprises; Custom Built Homes, Inc.; DACOH Holdings LLC; DeRolph, Brianne E.; DealPoint Merrill, LLC; Dean W. Fried Trust; Dinsmore & Shohl LLP; Dominic Howley; Donald W. Kelley and Associates, Inc.; DriftIndustry, LLC; Easton Hotel Holdings, LLC; Eleventh Avenue Properties; Equity; Fairfield Commercial Properties LLC; Fairway Acquisitions, LLC; Family Dollar; Garland Properties, Ltd.; Grandview 1341, LLC; Greenlawn Realty Company; Harrison West Ventures LLC; Hentsch, Ronald J.; Hinely, Aubrey L.; Historic Dennison Hotel LLC; Holiday Inn; Homeport; Howley, Dominic; JDS So Cal LTD; Jeffrey New Day Community Center LLC; John & Helen Wilt; Julia Pfeiffer; Kanellopoulos, George; Kanellopoulos, George & Laura; Kinnear Road Redevelopment LLC; Laurel Health Care; Liberty Place, LLC; Luteg High LLC; Lykens Companies; Mackey, Scott, T.; Marshall Acquisitions; Mid-City Electric Company; Moo Moo Express Car Wash LLC; N.P. Limited; NRP Group LLC, The; Nichols, James R. & Kelly J.; O'Keefe, Terry; OSU Properties LLC; Pagura Company; Peak Property Group; Roof to Road; Royal Tallow Holdings, Ltd.; Snyder-Barker Investments; St. Charles Preparatory; The Wood Companies; United Dairy Farmers; Victorian Heritage Homes LLC; Wagenbrenner Company, The; Walgreen Co.; Weinland Park Development LLC; Weinland Park Properties LLC; Weinland Senior LLC; Winham Investments LLC

**Agent name (status):** Malcolm Porter (Active)

**Clients:** BIA of Central Ohio; Central Ohio Trauma System; Columbus Medical Association; Columbus Medical Association Foundaton; Physicians Care Connection (Free Clinic/VCN)

**Agent name (status):** Larry Price (Active)

**Clients:** MWH Inc.; Resource International, Inc; Ribway engineering group, Inc.

**Agent name (status):** Daniel Rajaiah (Active)

**Clients:** Thirteenth Floor Entertainment Group

**Agent name (status):** Michael Reese (Active)

**Clients:** Columbus Apartment Association; DLZ Corporation; Kaufman Development; Neutron Holdings; Preferred Real Estate Investments, Inc; URM Services LLC

**Agent name (status):** Jackson Reynolds, III (Active)

**Clients:** 1000 S Front LLC ; 1354 Ida Avenue LLC ; 14th Hole Development LLC; 1774 LLC; 3540 WDG LLC; 3728 Agler Road LLC; 907 West Broad Real Estate LLC; ABL Group, Ltd.; ABR Holdings ; AED Enterprises LLC; AI Limited ; American Commerce Insurance Co.; Andrew Losinske; Anthony Thomas Company; Arlington Properties; Avalon Acquisition LLC; Avenue Partners LLC; BB Building Company of Western Ohio LLC; BB&S Laswer Systems, LLC; BLK Properties Inc.; Banyon Park Resources LLC; Bear Creek Capital Company ; Benjie Lewis; Black Wilshire Ridgely LLC ; Brick Investments Corp.; Bristol Group Inc.; Brookside Country Club LLC; Brookwood Construction; Buckeye

Express Wash; Buckeye Terminals ; Buckeye Wayfaring Hostel; Burroughs Property Holdings LLC; Burwell Investments LLC; Byers Chevrolet; Byers Mazda; CA Ventures; CB Busch Office Portfolio; CVCO, Inc.; Canini & Associates ; Cap City Hotel LLC; Capital Park Family Health Center Corp.; Capital Towing & Recovery; Casto Edwards Hayden Run Ltd; Casto Organization; Catherine Adams ; Cavin Carmell; Cela Real Estate Investment LLC; Charles J. Kistler ; Charlies Corner II ; Chemlawn Commercial LLC ; Chris Sherman; Church o f Scientology; Clintonville Academy; Colony Capital Inc; Columbus Bituminous Concrete Corp; Columbus Country Club ; Columbus Foundation Properties, LLC; Columbus Regional Airport Authority ; Comfy Couch Company; Community Development for All People; Conrad's College Gifts; Continental Bell, Ltd.; Continental Builders, Inc.; Continental Real Estate Companies; Continental Real Estate Companies ; Cooper Lakes II, LLC; Core Resources, Inc.; Core Resources, Inc.; Cornerstone Capital Partners Corporation; Costco Wholesale ; Cup O' Joe Holdings, Inc.; DGJL, LLC; DMI Metals ; Dan Tobin Buick GMC ; David Woods; Dennis Koon; Don Compton ; Don M. Casto Organization; Donald W. Kelley & Associates; Donley Concrete Cutting Co; Doug Tenenbaum; Dr. Chris Smiley; Duke Realty Corporation; E.V. Bishoff Company ; Edwards Communities Development Company; Edwards Companies ; Elford Development ; Energy Management LLC; Envisionpoint LLC; Epcon Communities ; Estate of George C. Smith ; Estate of Rebecca Larkins ; Evergreen Cemetery ; Evergreen Ventures, LLC; FST Logistics ; First Community Church of Columbus Ohio; Flexicom LLC; Four String Brewing Co; Furniture Bank of Central Ohio; Garry Rowe; Germain Lexus of Easton; Giant Eagle Inc.; Giuseppe Holdings LLC; Gray Gables Realty Inc.; Grismer Tire ; Hanks Holdings Ltd; Hayden Development LLC; Home Designs, Ltd.; Homewood Corp; Indus Companies; Info Depot LLC; Integrated Partners Development; Integration Resources Inc; Integrity Cycles; J. Johnson Investments LLC ; JC Roofing Supply ; JDS Acquisitions LLC; JVL Properties ; Jack and Ruth Strader; Joe Dirt Central Ohio LLC; Jupiter Ohio Inc; Just 1 LLC; Kevin Mullins; Kristin Boggs & Adam Ward; LAMS UNITED PROPERTIES, LLC; LDK Land, LLC; Lahoti Properties Ltd.; Lawyers Property Development Corporation; Lifestyle Communities ; Limited Brands; Lockbourne DG LLC; Long & Wilcox LLC; Low Country Imports; Lurie Family LP; Lutheran Social Services ; Lutheran Social Services of Central Ohio; M/I Homes of Central Ohio, LLC ; Marathon Petroleum Company LLC; Marathon Petroleum Company LP; Marillian LLC; Masjid as Sahaba; Matt Vekasy ; Menard, Inc.; Metropolitan Holdings LLC ; Metropolitan Partners; Michael Sabo, Sharon Sabo, David Sabo, Sandra Sabo; Morso Holding Co; Mosiaca Education Inc.; Mouth of Wilson LLC; New Village Communities LLC ; Nicholas J. Ford ; Northstar Realty; Northstar Realty; Northwest Property Management; Oakstone Academy; Ohio Hospital for Psychiatry ; Ohio Mulch; Ohio Mulch Incorporated; Olympic Beach Acquisitions LLC; Orange Barrel Media LLC ; PAR Electrical Contractors Inc.; Parson One LLC ; Pat Grabill & Company; Penn National Gaming, Inc.; Pet Palace Enterprises LLC; PetSuites of America, Inc.; Peter & Jill Dole; Phil Fulton; Platinum Lodging LLC ; Plaza Properties ; Provident Partners ; Provident United Inc; Public Storage Inc; RPMD, LLC; Rajesh Lahoti; Ramseyer Presbyterian Church; Ray Wilson Homes ; Redwood Acquisition LLC; Ricart Properties Ltd.; Robbins Realty; Robert Lytle ; Ron & Guy Blausner ; Ross Development ; Ruben-Lorek LLC ; S&Y Property Inc; SV Inc.; Sam Kahwach; Sarepta Therapeutics; Schottenstein Real Estate Group ; Sean & Barbara Brogan; Snyder-Barker Investment LLC ; Steve & Linda Genteline; Steve Jefferis; Stock Development Company LLC; TDH Investments ; TH Midwest Inc.; TOW Ltd.; Tansky's Sawmill Toyota, Inc.; Ted Lawson; The Ellis Company, Ltd.; The Ellis Company, Ltd.; The Ellis Company, Ltd.; The Kroger Co.; The Limited ; The Linden Cleve Theater ; The NRP Group LLC; The New Albany Company; The Ohio State University; The Ohio State University; The Stonehenge Company; The Witness Group; Thomas C. Smith; Thorntons Inc.; Today's Child Montessori School; Val Boehm; Village Communities; W2S3, Inc.; Wagbrenner Company; Wal-Mart Stores Inc.; Wallick Asset Management LLC; Weber Holdings South LLC; Westwood Cabinetry & Millwork LLC ; Will-Seff Properties; Wilmont Consultants; Workspace Arlington; ZBP Properties; deMonye's Greenhouse, Inc.

**Agent name (status):** Christopher Rinehart (Active)

**Clients:** John Stephenson; Local Mkt LLC; Regulator Properties ; Ronald and Ramona Whisler ; TH Midwest, Inc. (Turkey Hill); The Kroger Co.

**Agent name (status):** Brent Rosenthal (Active)

**Clients:** < No records found >

**Agent name (status):** James Rost (Active)

**Clients:** < No records found >



**Agent name (status):** David Schatz (Active)

**Clients:** < No records found >

**Agent name (status):** Ryan Schick (Active)

**Clients:** 182 SC LLC; Ameresco; Autonomy Hub; Blueline Training Solutions, LLC; Botavi Labs, LLC; CityNet, LLC; IGS Ventures, Inc. ; LOUD Capital; Make Columbus LLC; Mowtivate to Build, LLC; Multivarious, LLC; Varsity Club; Zoot Company

**Agent name (status):** Michael Shannon (Active)

**Clients:** A.J. Capital Partners; Campus Partners; Continental Real Estate Companies; Continental Real Estate Companies; Crossroads Group; Edwards Companies; Elsey Partners; Epcon Group, Inc.; Jared Schiff; Jay Schottenstein; Kaufman Development; Lifestyle Communities; Mike Baumann Plumbing, Inc.; Pizzuti Companies; Prospect Wango LLC; Quantum Health; Renewal Housing Associates, LLC; Robert Weiler Company; Schiff Capital Group, c/o Continental Development; Schiff Properties; Schmidt's Restaurant Haus; Schmidt's Sausage Haus; Skip Weiler; T&R Properties; T&R Properties; The Pizzuti Companies; The Robert Weiler Company; The Wood Companies; The Wood Companies; Thorntons, Inc.; Tom Bell Properties Ltd.

**Agent name (status):** John Singleton (Active)

**Clients:** Sandy Hook Promise; Volunteers of America

**Agent name (status):** Christopher Slagle (Active)

**Clients:** Verizon Wireless; Whirlpool Corporation

**Agent name (status):** Lee Smith (Active)

**Clients:** CompManagement Health Systems, Inc.; CompManagement, Inc.; Fifth Third Bank; GPD Group, Inc.; Ribway Engineering Group, Inc.

**Agent name (status):** Jeff Stephens (Active)

**Clients:** < No records found >

**Agent name (status):** Jill Tangeman (Active)

**Clients:** Grange Mutual Casualty Company; Nationwide Children's Hospital; Preferred Real Estate Investments II, LLC; Triangle Real Estate, Inc.; Village Communities, Inc.

**Agent name (status):** Test Test (Active)

**Clients:** Test Co 1

**Agent name (status):** Steve Tugend (Active)

**Clients:** < No records found >

**Agent name (status):** Aaron Underhill (Active)

**Clients:** Ben Rory LLC; Burwell Investments LLC; CA Ventures; CarCorp, Inc.; Center State Enterprises, LLC; DHOD, Inc.; DNC Hamilton Crossing LLC; DeVore Real Estate; Double D SC LLC; Evergreen Cemetery Association; HP Land Development, Ltd.; Hamilton Crossing LLC; Katz Tires; LMC (Lennar); Lane and Tuttle LLC; Lorri & Douglas Wolfe; M/I Homes of Central Ohio, LLC; Mark Alderman; Metropolitan Holdings; Ohio Attorney General/The Ohio State University; Preferred Living; Target Corp.; The Casto Organization; The Kroger Co.; The New Albany Company LLC; The Pharm Ohio LLC; Thorntons, Inc.; Village Network, Inc.

**Agent name (status):** MADISON WHALEN (Active)

**Clients:** The John Gore Organization

**Agent name (status):** Ian Weir (Active)

**Clients:** Citelum US

**Agent name (status):** Garth Weithman (Active)

**Clients:** < No records found >

**Agent name (status):** Nathan P. Wymer (Active)  
**Clients:** Nationwide

End of record.

Certification

Party did 'agree' to the registration and stated that all reasonable efforts and due diligence have been undertaken in the preparation and completion of the statement and that the contents are true and accurate to the best of the party's knowledge.