

Columbus City Bulletin



**Bulletin #31
August 5, 2023**

Proceedings of City Council

Saturday, August 5, 2023



SIGNING OF LEGISLATION

(Legislation was signed by Council President Shannon G. Hardin on the night of the Council meeting, *Monday, July 31, 2023*; by Mayor, Andrew J. Ginther on *Wednesday August 2, 2023*; and attested by Acting City Clerk, Jacob A. Dilley on *Wednesday August 2, 2023* prior to Bulletin publishing)

The City Bulletin Official Publication of the City of Columbus

Published weekly under authority of the City Charter and direction of the City Clerk. The Office of Publication is the City Clerk's Office, 90 W. Broad Street, Columbus, Ohio 43215, 614-645-7380. The City Bulletin contains the official report of the proceedings of Council. The Bulletin also contains all ordinances and resolutions acted upon by council, civil service notices and announcements of examinations, advertisements for bids and requests for professional services, public notices; and details pertaining to official actions of all city departments. If noted within ordinance text, supplemental and support documents are available upon request to the City Clerk's Office.

Council Journal (Minutes)



City of Columbus

Office of City Clerk
90 West Broad Street
Columbus OH
43215-9015
columbuscitycouncil.org

Minutes - Final Columbus City Council

Monday, July 31, 2023

5:00 PM

City Council Chambers, Rm 231

REGULAR MEETING NO. 40 OF COLUMBUS CITY COUNCIL, JULY 31, 2023 at 5:00 P.M. IN COUNCIL CHAMBERS.

ROLL CALL

Present: 7 - Nicholas Bankston, Lourdes Barroso De Padilla, Mitchell Brown, Rob Dorans, Shayla Favor, Emmanuel Remy, and Shannon Hardin

READING AND DISPOSAL OF THE JOURNAL

A motion was made by Emmanuel V. Remy, seconded by Rob Dorans, to Dispense with the reading of the Journal and Approve. The motion carried by the following vote:

Affirmative: 7 - Nicholas Bankston, Lourdes Barroso De Padilla, Mitchell Brown, Rob Dorans, Shayla Favor, Emmanuel Remy, and Shannon Hardin

ADDITIONS OR CORRECTIONS TO THE JOURNAL

COMMUNICATIONS AND REPORTS RECEIVED BY CITY CLERK'S OFFICE

- 1 [C0021-2023](#) THE FOLLOWING COMMUNICATIONS WERE RECEIVED BY THE CITY CLERK'S OFFICE AS OF WEDNESDAY JULY 26, 2023.

Transfer Type: D5 D6
To: Xiang Feast LLC
DBA Pacific Eatery & Catering
4514 Kenny Rd Ste B
Columbus, OH 43220
From: E M Chung LLC
DBA Pacific Eatery & Catering
4515 Kenny Rd Ste B
Columbus, OH 43220
Permit #: 9804439

New Type: D1
To: North City Tavern LLC
& Patio
46 Dillmont Dr
Columbus, OH 43235
Permit #: 6458712

New Type: D5
To: Seitans Realm LLC
3494-3496 N High St
Columbus, OH 43214
Permit #: 79482270005

New Type: D2
To: Hogan Hospitality LLC
DBA Lotus Lounge
6068 Channingway Blvd
Columbus, OH 43232
Permit #: 3906068

New Type: D2
To: Kyashu Ramen LLC
1280 W 5th Ave
Columbus, OH 43212
Permit #: 4940690

New Type: D1
To: Thai On High LLC
DBA Khaotown Bar
972 N High St
Columbus, OH 43201
Permit #: 88712610005

Transfer Type: D5
To: Skats LLC
8701 Lyra Dr
Columbus, OH 43240
From: Dive Bars of Ohio Corp
3024 Sullivant Ave
Columbus, OH 43204
Permit #: 9219518

Transfer Type: C1 C2 D6
To: Beechcroft 1935 Newsstand Corp
1935 E Dublin Granville Rd
Columbus, OH 43229
From: Carlas Newstand LLC
1935 E Dublin Granville Rd
Columbus, OH 43229
Permit #: 0570675

Advertise Date: 8/5/23

Agenda Date: 7/31/23

Return Date: 8/10/23

Read and Filed

RESOLUTIONS OF EXPRESSION

FAVOR

- 2 [0150X-2023](#) To Designate August 31st, 2023 as International Overdose Awareness Day in the City of Columbus

Sponsors: Shayla Favor, Nicholas Bankston, Lourdes Barroso De Padilla, Mitchell Brown, Rob Dorans, Emmanuel V. Remy and Shannon G. Hardin

A motion was made by Shayla Favor, seconded by Emmanuel V. Remy, that this Ceremonial Resolution be Adopted. The motion carried by the following vote:

Affirmative: 7 - Nicholas Bankston, Lourdes Barroso De Padilla, Mitchell Brown, Rob Dorans, Shayla Favor, Emmanuel Remy, and Shannon Hardin

ADDITIONS OR CORRECTIONS TO THE AGENDA

THE FOLLOWING ORDINANCE WAS REMOVED FROM THE CONSENT PORTION OF THE AGENDA AND VOTED ON LATER IN THE MEETING. RECREATION AND PARKS COMMITTEE: 1552-2023

FR FIRST READING OF 30-DAY LEGISLATION

A motion was made by Shayla Favor, seconded by Rob Dorans, to waive the reading of the titles of first reading legislation. The motion carried by the following vote:

Affirmative: 7 - Nicholas Bankston, Lourdes Barroso De Padilla, Mitchell Brown, Rob Dorans, Shayla Favor, Emmanuel Remy, and Shannon Hardin

ECONOMIC DEVELOPMENT: BANKSTON, CHR. REMY DORANS HARDIN

- FR-1 [1831-2023](#) To authorize the Director of the Department of Development to enter into a grant agreement with St. Mary School, Inc.; to authorize the expenditure of \$500,000.00 from the Development Taxable Bond Fund and to allow for expenditures prior to the Purchase Order. (\$500,000.00)

Read for the First Time

- FR-2 [1833-2023](#) To authorize the Director of the Department of Development to enter into a Grant Agreement with Elevate Northland in an amount of up to \$500,000.00, to advance the planning, design and construction of new

community center space to continue providing training and business incubation assistance to the Northland community; and to authorize the expenditure of \$500,000.00 from the Development Taxable Bond Fund and to allow for expenditures prior to the Purchase Order. (\$500,000.00)

Read for the First Time

FR-3 [2186-2023](#)

To authorize the Director of the Department of Development to enter into a Grant Agreement with Ronald McDonald House Charities of Central Ohio, Inc., in an amount not to exceed \$1,000,000.00, to advance the planning, design and construction of the new expansion to their facility located at 711 E. Livingston Avenue across from Nationwide Children's Hospital; and to authorize the expenditure of \$1,000,000.00 from the Development Taxable Bond Fund. (\$1,000,000.00)

Read for the First Time

FR-4 [2228-2023](#)

This legislation is to authorize the Director of the Department of Development to amend the City of Columbus Community Reinvestment Area Agreement for the third time to right size the job creation commitment based on the revised reduced amount of square footage of the project per the Tax Incentive Review Council ("TIRC") recommendations, and to determine the current Carryforward Amount.

Read for the First Time

FR-5 [2305-2023](#)

To authorize the Director of the Department of Development to enter into a contract with Priscilla Tyson Consulting, LLC to assist in the completion and opening of the Poindexter Village Museum and Cultural Center (PVMCC); to authorize the appropriation and expenditure within the Neighborhood Initiatives subfund; and to waive the competitive bidding provisions of the Columbus City Codes. (\$100,000.00)

Sponsors: Shannon G. Hardin, Mitchell Brown and Nicholas Bankston

Read for the First Time

SMALL & MINORITY BUSINESS: BANKSTON, CHR. REMY BARROSO DE PADILLA HARDIN

FR-6 [2187-2023](#)

To authorize the Director of the Department of Development to enter into a grant agreement with Freedom Equity, Inc. in an amount up to \$1,500,000.00 for a micro loan program to support small minority businesses; to authorize the transfer of \$1,500,000.00 between the Citywide Account and the Department of Development; to authorize the expenditure of up to \$1,500,000.00 from the General Fund; and to authorize the advancement of funds on a pre-determined schedule

during the term of the agreement. (\$1,500,000.00)

Read for the First Time

TECHNOLOGY: BANKSTON, CHR. DORANS BROWN HARDIN

- FR-7** [2147-2023](#) To authorize the Director of the Department of Technology to renew an agreement with Columbus Fibernet, LLC (CFN) for fiber optic cable maintenance services for the CFN fiber duct system in support of the City's fiber optic infrastructure; and to authorize the expenditure of \$82,746.45 from the Department of Technology, Information Services Division, Information Services Operating Fund. (\$82,746.45)

Read for the First Time

- FR-8** [2266-2023](#) To appropriate \$610,000.00 to the Department of Technology, Information Services Division, from the unappropriated cash balance of the Information Services Operating Fund; to authorize the Director of the Department of Technology to enter into a non-profit services contract with Smart Columbus LLC in an amount up to \$610,000.00 to support the ongoing efforts and work of the Smart Columbus organization; and to authorize the expenditure of \$610,000.00 from the Information Services Operating Fund. (\$610,000.00)

Read for the First Time

PUBLIC SERVICE & TRANSPORTATION: BARROSO DE PADILLA, CHR. FAVOR BANKSTON HARDIN

- FR-9** [2198-2023](#) To dedicate a tract of real property owned by the City of Columbus as road right-of-way; to name said public right-of way as Central College Road. (\$0.00)

Read for the First Time

- FR-10** [2249-2023](#) To extinguish a 7.195 acre portion of right-of-way north of Aircenter Drive and east of Stelzer Road; and to transfer the asset to Columbus Regional Airport Authority.

Read for the First Time

RECREATION & PARKS: BROWN, CHR. DORANS BANKSTON HARDIN

- FR-11** [2096-2023](#) To authorize the Director of Recreation and Parks to apply for grant funding from the Ohio Department of Natural Resources (ODNR) H2Ohio water quality initiative which will be used to restore wetlands at Three Creeks Park. (\$0.00)

Read for the First Time

FR-12 [2099-2023](#) To authorize the Director of the Recreation and Parks Department to issue a nonexclusive sewer easement to the Village of Galena for installation of a subsurface sanitary sewer to provide services to their Miller Farms development. (\$0.00)

Read for the First Time

FR-13 [2100-2023](#) To authorize the Director of the Recreation and Parks Department to issue a nonexclusive sewer easement to the YWCA for installation of storm water services at Franklin County Tax Parcel 010-261917-00, which is managed as the Majestic Paint Parkland by the Recreation and Parks Department. (\$0.00)

Read for the First Time

EDUCATION: BROWN, CHR. FAVOR BARROSO DE PADILLA HARDIN

FR-14 [2148-2023](#) To authorize the Director of the Office of Education to enter into a contract with the Crane Center for Early Childhood Research and Policy at The Ohio State University to implement Ready4Success, a screening and improvement strategy, and Read It Again, Read it Again - Math, and to provide mid-year student assessment; and to authorize the expenditure of \$491,000.00 from the General Fund. (\$491,000.00)

Read for the First Time

PUBLIC UTILITIES: DORANS, CHR. BANKSTON REMY HARDIN

FR-15 [1880-2023](#) To authorize the Director of Public Utilities to enter into a service agreement in accordance with the relevant provisions of Chapter 329 of the City Code pertaining to waiver of competitive bidding, with The Ohio State University, Office of Sponsored Programs, for the NPDES Stormwater and Clintonville Blueprint Monitoring Project for the Division of Sewerage and Drainage, Stormwater and Regulatory Management Section; and to authorize the expenditure of \$275,000.00 from the Storm Sewer Operating Fund. (\$275,000.00)

Read for the First Time

WORKFORCE DEVELOPMENT: DORANS, CHR. FAVOR BROWN HARDIN

FR-16 [2276-2023](#) To authorize the City Clerk to enter into contract with Wentz, McInerney, Peifer & Petroff, LLC for legal and educational services in support of the work of the Community Benefits Agreement Advisory Committee; to authorize an appropriation and expenditure of \$20,000.00 from the Job Growth subfund. (\$20,000.00)

Sponsors: Rob Dorans

Read for the First Time

HOUSING: FAVOR, CHR. BROWN BANKSTON HARDIN

- FR-17 [2013-2023](#) To authorize the Director of Development to enter into a First Amendment to the Bond Funded Grant Agreement with Erie Ohio Capital CDFI Fund, LLC, to permit the reimbursement of project costs incurred prior to the creation of the purchase order. (\$0.00)

Read for the First Time

- FR-18 [2268-2023](#) To authorize the Director of Development to execute a Grant Agreement with Rebuilding Together Central Ohio dba ModCon Living, in an amount up to \$270,000.00 towards providing home repair services to residents of the North Central community; and to authorize an appropriation and expenditure of \$270,000.00 within the Neighborhood Initiatives Subfund; and to authorize reimbursement of expenses incurred prior to execution of the purchase order. (\$270,000.00)

Sponsors: Emmanuel V. Remy

Read for the First Time

HEALTH & HUMAN SERVICES: FAVOR, CHR. BARROSO DE PADILLA BROWN HARDIN

- FR-19 [2233-2023](#) To authorize the Finance and Management Director to enter into a Universal Term Contract for the option to purchase Child and Infant Car Safety Seats with Evenflo Co., Inc.; and to authorize the expenditure of \$1.00. (\$1.00)

Read for the First Time

PUBLIC SAFETY: REMY, CHR. BARROSO DE PADILLA DORANS HARDIN

- FR-20 [2242-2023](#) To authorize the Finance and Management Director to associate all general budget reservations resulting from this ordinance with the appropriate Universal Term Contract Purchase Agreement with Brown Enterprise Solutions, LLC for the purchase of computers, monitors, and accessories, on behalf of the Department of Public Safety, Division of Support Services; to authorize the expenditure of \$179,303.12 from the Division of Support Services' general fund operating budget. (\$179,303.12)

Read for the First Time

ENVIRONMENT: REMY, CHR. BARROSO DE PADILLA FAVOR HARDIN

- FR-21** [2291-2023](#) To authorize the City Clerk to enter into a grant agreement with the Garden Club Project; and to authorize an appropriation and expenditure within the Neighborhood Initiatives subfund. (\$10,000.00)

Sponsors: Mitchell Brown and Emmanuel V. Remy

Read for the First Time

RULES & REFERENCE: HARDIN, CHR. BROWN REMY FAVOR

DORANS

- FR-22** [1945-2023](#) To amend various sections of Title 11, Chapters 1145 and 1147, of the Columbus City Codes to make changes to the restrictions, prohibitions, and prohibited activities related to trucked wastes and dumping procedures at a specific facility, referred to as the TWDS (Trucked Waste Discharge Station).

Sponsors: Rob Dorans

Read for the First Time

CA CONSENT ACTIONS

RESOLUTIONS OF EXPRESSION:

FAVOR

- CA-1** [0151X-2023](#) To Commend the Columbus Women's Commission on their Advocacy for Black Women's Pay Equity

Sponsors: Shayla Favor, Nicholas Bankston, Lourdes Barroso De Padilla, Mitchell Brown, Rob Dorans, Emmanuel V. Remy and Shannon G. Hardin

This item was approved on the Consent Agenda.

REMY

- CA-2** [0145X-2023](#) To recognize and celebrate the 50th Annual Greek Festival in Columbus.

Sponsors: Emmanuel V. Remy, Nicholas Bankston, Lourdes Barroso De Padilla, Mitchell Brown, Rob Dorans, Shayla Favor and Shannon G. Hardin

This item was approved on the Consent Agenda.

ECONOMIC DEVELOPMENT: BANKSTON, CHR. REMY DORANS HARDIN

- CA-3** [1866-2023](#) To authorize the Director of the Department of Development to enter into an Economic Development Agreement with WESTBEND QOZB, LLC to outline the mutual plans and certain commitments of the parties as it relates to the WestBend development on the former site of Buckeye Auto Parks property on McKinley Avenue.
- This item was approved on the Consent Agenda.**
- CA-4** [1961-2023](#) To accept the application (AN23-003) of Airport Commerce Park LLC for the annexation of certain territory containing 2.3± acres in Mifflin Township.
- This item was approved on the Consent Agenda.**
- CA-5** [1963-2023](#) To accept the application (AN23-004) of Michael and Lindy McGaughey for the annexation of certain territory containing 0.1± acres in Sharon Township.
- This item was approved on the Consent Agenda.**
- CA-6** [1964-2023](#) To accept the application (AN23-005) of Michael and Lindy McGaughey for the annexation of certain territory containing 0.1± acres in Sharon Township.
- This item was approved on the Consent Agenda.**
- CA-7** [1966-2023](#) To accept the application (AN23-008) of John Martin & David Martin for the annexation of certain territory containing 0.8± acres in Jackson Township.
- This item was approved on the Consent Agenda.**
- CA-8** [2093-2023](#) To authorize the appropriation and transfer of \$10,000.00 of service payments in lieu of taxes between the Milo-Grogan TIF Fund and the Housing Business Tax Incentive Fund; to authorize the appropriation and transfer of \$5,000.00 annually of service payments in lieu of taxes between the Milo-Grogan TIF Fund and the Housing Business Tax Incentive Fund during the term of the tax increment financing agreement; to appropriate and authorize the expenditure of service payments in lieu of taxes deposited, or to be deposited, into the Milo-Grogan TIF Fund to the developer or its designee; to authorize the Director of the Department of Development, on behalf of the City, to enter into a tax increment financing agreement between the City and Half Baked Holdings, LLC for reimbursement of certain public infrastructure improvements, as defined by R.C. 5709.40(A)(8). (\$10,000.00)
- This item was approved on the Consent Agenda.**
- CA-9** [2171-2023](#) To accept the application (AN23-011) of Bachman Farm Ltd. for the

annexation of certain territory containing 63.8± acres in Madison Township.

This item was approved on the Consent Agenda.

CA-10 [2173-2023](#)

To accept the application (AN23-011) of Bachman Farm Ltd. for the annexation of certain territory containing 30.7± acres in Madison Township.

This item was approved on the Consent Agenda.

CA-11 [2230-2023](#)

To set forth a statement of municipal services and zoning conditions to be provided to the area contained in a proposed annexation (AN23-016) of 22.7± Acres in Prairie Township to the city of Columbus as required by the Ohio Revised Code; and to declare an emergency.

This item was approved on the Consent Agenda.

SMALL & MINORITY BUSINESS: BANKSTON, CHR. REMY BARROSO DE PADILLA HARDIN

CA-12 [2299-2023](#)

To authorize the City Clerk to enter into a grant agreement with Columbus Fashion Council to support the Fashion Week event and programming; to authorize an appropriation within the Job Growth subfund; to authorize a transfer of appropriations within the general fund; to authorize an expenditure from the general fund; and to declare an emergency. (\$50,000.00)

Sponsors: Nicholas Bankston and Lourdes Barroso De Padilla

A motion was made by Emmanuel V. Remy, seconded by Mitchell Brown, that this Ordinance be Approved. The motion carried by the following vote:

Abstained: 1 - Shayla Favor

Affirmative: 6 - Nicholas Bankston, Lourdes Barroso De Padilla, Mitchell Brown, Rob Dorans, Emmanuel Remy, and Shannon Hardin

TECHNOLOGY: BANKSTON, CHR. DORANS BROWN HARDIN

CA-13 [2142-2023](#)

To authorize the Director of the Department of Technology to renew a contract with Brown Enterprises LLC for Smartsheet Control Center subscriptions and licenses; to authorize the expenditure of up to \$158,529.00 from the Department of Technology, Information Services Operating Fund for the above-mentioned purpose; and to declare an emergency. (\$158,529.00)

This item was approved on the Consent Agenda.

CA-14 [2174-2023](#)

To authorize the Director of the Department of Technology, for various Departments, to enter into a renewal agreement with VCloud Tech,

Inc. for the renewal of annual software support and maintenance for Netmotion software licenses; to authorize the expenditure of \$89,722.95 from the Department of Technology, Information Services Operating Fund; and to declare an emergency (\$89,722.95).

This item was approved on the Consent Agenda.

**PUBLIC SERVICE & TRANSPORTATION: BARROSO DE PADILLA, CHR.
FAVOR BANKSTON HARDIN**

CA-15 [2118-2023](#) To authorize the Director of the Department of Public Service to execute those documents necessary for the transfer of a 0.055 acre portion of the un-named alley that is adjacent to 1954 Kenton Avenue to Molly C. Mount. (\$23,950.00)

This item was approved on the Consent Agenda.

CA-16 [2157-2023](#) To authorize the establishment of an Auditor's Certificate for construction inspection and administration fees; and to authorize the expenditure of up to \$300,000.00 from the Streets and Highways Bond Fund for the purpose of providing sufficient funding for construction inspection and administration services on Public Service projects. (\$300,000.00)

This item was approved on the Consent Agenda.

CA-17 [2201-2023](#) To authorize and direct the City Auditor to set up a certificate in the amount of \$80,000.00 for the purchase and installation of snow and lighting equipment for the Department of Public Service, Division of Traffic Management; to authorize and direct the Director of Finance and Management to solicit bids and enter into contract for the purchase and installation of snow and lighting equipment on behalf of the Department of Public Service, Division of Traffic Management; to authorize the expenditure of up to \$80,000.00 from the Municipal Motor Vehicle Tax Fund; and to declare an emergency. (\$80,000.00).

This item was approved on the Consent Agenda.

CA-18 [2243-2023](#) To authorize the Director of the Department of Public Service to enter into agreements with Norfolk Southern Railway Company, and other railroad companies as needed, relative to the Bridge Rehabilitation - Front St and Nationwide Blvd project; to authorize the expenditure of up to \$40,000.00 from the Streets and Highways Bond Fund for this project; and to declare an emergency. (\$40,000.00)

This item was approved on the Consent Agenda.

**NEIGHBORHOODS AND IMMIGRANT, REFUGEE, AND MIGRANT
AFFAIRS: BARROSO DE PADILLA, CHR. DORANS REMY HARDIN**

CA-19 [2212-2023](#) To authorize the Director of the Department of Neighborhoods to enter into grant agreements with the following not-for-profit agencies in support of summer youth employment and programs: Liberians in Columbus Inc.; to authorize the transfer, appropriation and expenditure of \$50,000.00 within the general fund; to authorize the payment of expenses starting May 22, 2023; and to declare an emergency. (\$50,000.00)

This item was approved on the Consent Agenda.

CA-20 [2213-2023](#) This ordinance will modify Ordinance 1585-2023 passed on May 22, 2023 to correct the organization name originally listed as Ohio Black Dance to OhioDance on behalf of Ohio Black Dance and authorize the Director of the Department of Neighborhoods to enter into a service agreement with the not-for-profit agency OhioDance on behalf of Ohio Black Dance; and to declare an emergency.

This item was approved on the Consent Agenda.

CA-21 [2214-2023](#) This ordinance will modify Ordinance 1582-2023 passed on May 22, 2023 to correct the organization name originally listed as Legacy Youth Academy to Legacy Youth Sports Academy and authorize the Director of the Department of Neighborhoods to enter into a service agreement with the not-for-profit agency Legacy Youth Sports Academy; and to declare and emergency.

This item was approved on the Consent Agenda.

CA-22 [2277-2023](#) To authorize the City Clerk to enter into a grant agreement with the Columbus Association for the Performing Arts (CAPA) in support of the Little Amal event; to authorize an appropriation and expenditure within the Neighborhood Initiatives subfund; and to declare an emergency. (\$10,000.00)

Sponsors: Emmanuel V. Remy

This item was approved on the Consent Agenda.

CA-23 [2284-2023](#) To authorize the City Clerk to enter into a grant agreement with People Like Me Project, Inc. for youth community engagement programming; to authorize an appropriation and expenditure of \$5,500.00 from the Neighborhood Initiatives subfund; and to declare an emergency (\$5,500.00).

Sponsors: Nicholas Bankston

This item was approved on the Consent Agenda.

CA-24 [2290-2023](#) To authorize the City Clerk to enter into a grant agreement with the New American Community Information Center in support of the New

Americans Book Fair; to authorize an appropriation and expenditure within the Neighborhood Initiatives subfund; and to declare an emergency. (\$10,000.00)

Sponsors: Lourdes Barroso De Padilla and Emmanuel V. Remy

This item was approved on the Consent Agenda.

VETERANS, SENIOR, & DISABILITY AFFAIRS: BARROSO DE PADILLA, CHR. BROWN FAVOR HARDIN

CA-25 [2158-2023](#) To authorize and direct the Director of Recreation and Parks to enter into a non-profit service contract with The Gladden Community House to provide supportive and home modification services to older adults in Central Ohio for the period of July 1, 2023, to September 30, 2024; to authorize the expenditure of \$60,000.00 from the Recreation and Parks Grant Fund; and to declare an emergency. (\$60,000.00)

A motion was made by Emmanuel V. Remy, seconded by Mitchell Brown, that this Ordinance be Approved. The motion carried by the following vote:

Abstained: 1 - Nicholas Bankston

Affirmative: 6 - Lourdes Barroso De Padilla, Mitchell Brown, Rob Dorans, Shayla Favor, Emmanuel Remy, and Shannon Hardin

CA-26 [2294-2023](#) To amend Ordinance No. 1710-2023, passed by Columbus City Council on July 10, 2023, to allow for a correction of the name of two (2) of the organizations in Exhibit A, from "Avalon Adult Day Service Corp. dba: Complete Adult Day Service Corp" to "Complete Adult Day Service", "Lancaster-Fairfield Community Action Program Commission" to "Community Action Program Commission of the Lancaster Fairfield County Area Inc"; and to declare an emergency.

This item was approved on the Consent Agenda.

RECREATION & PARKS: BROWN, CHR. DORANS BANKSTON HARDIN

CA-28 [2098-2023](#) To authorize the Director of Recreation and Parks to modify an existing contract with Pavement Protectors, Inc. DBA M&D Blacktop for the Hard Surface Improvements 2021-2022 Project; to authorize the transfer of \$135,000.00 within the Recreation and Parks Voted Bond Fund, to authorize the amendment of the 2023 Capital Improvements Budget; to authorize the expenditure of \$135,000.00 from the Recreation and Parks Voted Bond Fund; and to declare an emergency. (\$135,000.00)

This item was approved on the Consent Agenda.

CA-29 [2102-2023](#) To authorize the Director of the Recreation and Parks Department to execute and acknowledge any documents or agreements, as

approved by the City Attorney, to amend, release, modify, or enter into new Environmental Covenants involving City owned real property located near Rocky Fork Creek; to grant a sewer easement to the City of New Albany for a new public park (Taylor Farm); and to declare an emergency. (\$0)

This item was approved on the Consent Agenda.

CA-30 [2227-2023](#)

To amend ordinance 1521-2023 to authorize the Director of the Recreation and Parks Department to enter into a City funded grant agreement for youth programming with Telos Training, Inc DBA The Charles Madison Nabrit Memorial Garden instead of The Charles Madison Nabrit Memorial Garden; to authorize the purchase of food by grantees authorized under 1521-2023; and to declare an emergency. (\$0.00)

This item was approved on the Consent Agenda.

PUBLIC UTILITIES: DORANS, CHR. BANKSTON REMY HARDIN

CA-31 [1975-2023](#)

To authorize the Finance and Management Director to associate all General Budget Reservations resulting from this ordinance with the appropriate Universal Term Contract Purchase Agreements for the purchase of lamps for the Division of Power; and to authorize the expenditure of \$60,000.00 from the Electricity Operating Fund. (\$60,000.00)

This item was approved on the Consent Agenda.

CA-32 [1998-2023](#)

To authorize the Director of the Department of Finance and Management to enter into a contract with White Oak Environmental & Safety for the purchase of a Blackline Gas Detectors and Accessories for the Division of Sewerage and Drainage; and to authorize the expenditure of \$93,389.00 from the Division of Sewer Operating Fund; (\$93,389.00)

This item was approved on the Consent Agenda.

CA-33 [2043-2023](#)

To authorize the Director of Public Utilities to modify an Indefinite Quantity Agreement Contract with Deere Valley Farms for the Class B Liquid Biosolids Land Application Program; and to authorize the expenditure of \$562,515.00 from the Sanitary Sewerage Operating Fund; (\$562,515.00)

This item was approved on the Consent Agenda.

CA-34 [2082-2023](#)

To authorize the Director of the Department of Finance and Management to enter into a contract with Brown Enterprise Solutions, LLC for the purchase of a Dell servers and tape drives for the Division of Sewerage and Drainage; and to authorize the expenditure of

\$81,285.00 from the Sanitary Sewer Operating Fund. (\$81,285.00)

This item was approved on the Consent Agenda.

CA-35 [2105-2023](#)

To authorize the Director of the Department of Public Utilities to modify and increase the contract with T&M Associates for the DPU General Engineering Consultant Services #5 Project; to authorize an amendment to the 2023 Capital Improvement Budget; and to authorize an expenditure of up to \$500,000.00 within the Sanitary Bond Fund to pay for the contract modification. (\$500,000.00)

This item was approved on the Consent Agenda.

CA-36 [2271-2023](#)

To authorize the Director of the Department of Public Utilities to enter into a non-profit service contract with Solar United Neighbors for implementation of the Solar Co-op Management Program, a low- to moderate-income (LMI) solar program that increases engagement of low-income communities and maximizes the benefits that low-income households receive from solar; to appropriate \$499,500.00 from the unappropriated balance of the Sustainable Columbus Fund; to authorize the expenditure of \$499,500.00 from the Sustainable Columbus Fund; and to declare an emergency. (\$499,500.00)

This item was approved on the Consent Agenda.

BUILDING AND ZONING POLICY: DORANS, CHR. BANKSTON FAVOR HARDIN

CA-37 [2119-2023](#)

To authorize the Director of Finance and Management to establish a purchase order for the purchase of vehicles for the Department of Building and Zoning Services; to authorize an expenditure from the Development Services Fund; and to declare an emergency. (\$209,952.00)

This item was approved on the Consent Agenda.

HOUSING: FAVOR, CHR. BROWN BANKSTON HARDIN

CA-38 [2126-2023](#)

To authorize the Director of the Department of Development to enter into the necessary lease agreement as needed for the use, operation, lease, and management of 925-927 Mt. Vernon Avenue, Columbus, Ohio 43203 (010-041015) by Maroon Arts Group.

A motion was made by Emmanuel V. Remy, seconded by Mitchell Brown, that this Ordinance be Approved. The motion carried by the following vote:

Abstained: 1 - Shayla Favor

Affirmative: 6 - Nicholas Bankston, Lourdes Barroso De Padilla, Mitchell Brown, Rob Dorans, Emmanuel Remy, and Shannon Hardin

CA-39 [2178-2023](#) To authorize the Director of Development to execute a Grant Agreement with Columbus State Community College for the provision of funding housing-focused case management positions within the Success Bridge program, in an amount up to \$400,000.00 of U.S. Department of Treasury Emergency Rental Assistance 2 (ERA 2) funds; to authorize an agreement start date of August 1, 2023; to authorized the expenditure of up to \$400,000.00 from the Emergency Rental Assistance 2 Fund; and to declare an emergency. (\$400,000.00)

This item was approved on the Consent Agenda.

CA-40 [2179-2023](#) To authorize the Director of the Department of Development to execute a Grant Agreement with Gladden Community House Inc., in an amount up to \$155,890.00, of U.S. Department of Treasury Emergency Rental Assistance 2 (ERA 2) funds to eligible recipients as part of the department's ERA 2 Strategy; to authorize an agreement start date of August 1, 2023; to authorize the payment of eligible expenses through September 30, 2025; to authorized the advancement of funds on a pre-determined schedule during the term of the agreement; to authorized the expenditure of up to \$155,890.00 from the Emergency Rental Assistance 2 Fund; and to declare an emergency. (\$155,890.00)

A motion was made by Emmanuel V. Remy, seconded by Mitchell Brown, that this Ordinance be Approved. The motion carried by the following vote:

Abstained: 1 - Nicholas Bankston

Affirmative: 6 - Lourdes Barroso De Padilla, Mitchell Brown, Rob Dorans, Shayla Favor, Emmanuel Remy, and Shannon Hardin

CRIMINAL JUSTICE & JUDICIARY: FAVOR, CHR. DORANS BARROSO DE PADILLA HARDIN

CA-41 [2192-2023](#) To authorize the City Clerk to enter into a \$20,000.00 grant agreement with Winbush Enterprises Inc. in support of their WEI Pardon/Re-entry Initiative; and to authorize an appropriation and expenditure within the Neighborhood Initiatives subfund. (\$20,000.00)

Sponsors: Shannon G. Hardin, Rob Dorans and Shayla Favor

This item was approved on the Consent Agenda.

HEALTH & HUMAN SERVICES: FAVOR, CHR. BARROSO DE PADILLA BROWN HARDIN

CA-42 [2006-2023](#) To authorize and direct the Office of CelebrateOne to accept funds from the Central Ohio Hospital Council on behalf of Ohio Better Birth Outcomes, in the amount of \$100,000.00 to support operational

capacity of CelebrateOne; and to authorize the appropriation of \$100,000.00 to the City's Private Grants Fund 2291. (\$100,000.00)

This item was approved on the Consent Agenda.

CA-43 [2074-2023](#)

To authorize the Director of the Department of Development to modify the scope of services in a Not for Profit Services Contract with Community Shelter and to extend the agreement term to June 30, 2025. (\$0.00)

This item was approved on the Consent Agenda.

CA-44 [2077-2023](#)

To authorize and direct the Board of Health to accept a grant from the Ohio Environmental Protection Agency in the amount of \$50,000.00 for the 2023 WPCLF program; to authorize the appropriation of \$50,000.00 and any additional funds from the unappropriated balance of the Health Department Grants Fund; and to authorize the City Auditor to transfer appropriations between object classes for the 2023 WPCLF program; (\$50,000.00)

This item was approved on the Consent Agenda.

CA-45 [2087-2023](#)

To authorize the Board of Health to accept a grant from the ADAMH Board of Franklin County in the amount of \$5,000.00; to authorize the appropriation of \$5,000.00 to the Health Department in the Health Department Grants Fund; and to declare an emergency. (\$5,000.00)

This item was approved on the Consent Agenda.

CA-46 [2091-2023](#)

To authorize the appropriation for the Health Department's Alcohol and Drug Services Division Grant Fund, Performance Incentive Fund, in various object classes, for the continued operations of the Performance Incentive Fund grant program; to authorize the Board of Health to appropriate and/or transfer any additional Performance Incentive Fund grant funds moving forward. (\$137,958.53)

This item was approved on the Consent Agenda.

CA-47 [2181-2023](#)

To authorize and direct the Board of Health to accept a 2023-2024 STD Surveillance (SSuN) Grant from the Centers for Disease Control and Prevention; to authorize the appropriation of \$250,000.00 from the unappropriated balance of the Health Department Grants Fund; and to declare an emergency. (\$250,000.00)

This item was approved on the Consent Agenda.

CA-48 [2262-2023](#)

To authorize the Director of the Department of Development to enter into a Beneficiary Grant Agreement with Besa Community Inc., in an amount up to \$300,000.00, using federal American Rescue Plan Act (ARPA) funds to support and increase the organizational capacity of the not-for-profit to service disproportionately impacted census tracts

and to pay for operational expenses starting January 1, 2023; to authorize the Director of the Department of Development to modify the terms and conditions of the Beneficiary Grant Agreement as needed without seeking further City Council approval in order to align with the most current version of the laws, regulations, and guidance; to authorize the expenditure of up to \$300,000.00 of ARPA funds; and to declare an emergency. (\$300,000.00)

This item was approved on the Consent Agenda.

CA-49 [2278-2023](#)

To authorize the City Clerk to enter into a grant agreement with Kaleidoscope Youth Center in support of their Wellness Initiative and Emergency Housing programs; to authorize an appropriation and expenditure within the Neighborhood Initiatives subfund; and to declare an emergency. (\$250,000.00)

Sponsors: Shannon G. Hardin

This item was approved on the Consent Agenda.

CA-50 [2279-2023](#)

To authorize the City Clerk to enter into a grant agreement with the Columbus Kappa Foundation in support of their Opiate Community Connectors Program; to authorize an appropriation and expenditure within the Neighborhood Initiatives subfund; and to declare an emergency. (\$25,000.00)

Sponsors: Shayla Favor, Shannon G. Hardin and Emmanuel V. Remy

This item was approved on the Consent Agenda.

PUBLIC SAFETY: REMY, CHR. BARROSO DE PADILLA DORANS HARDIN

CA-51 [2250-2023](#)

To authorize the Director of the Department of Public Safety to enter into contract with Idemia Identity & Security USA, LLC., to continue payments for the upgraded Automated Fingerprint Identification System (AFIS) for the Division of Police in accordance with the sole source provisions of the Columbus City Codes; to authorize the appropriation of \$491,711.50 within the Special Income Tax Debt Fund; to authorize an expenditure of \$983,423.00 from the General Fund and Special Income Tax Fund; and to declare an emergency. (\$983,423.00)

This item was approved on the Consent Agenda.

CA-52 [2280-2023](#)

To appropriate \$106,000.00 within the Public Safety Initiative subfund to the Department of Public Safety to provide forgivable home loans for the Safety Forces Residential Incentive Program; and to declare an emergency. (\$106,000.00)

Sponsors: Emmanuel V. Remy

This item was approved on the Consent Agenda.

- CA-53** [2286-2023](#) To authorize the Director of Finance and Management to enter into a grant agreement with End the Violence in support of community violence intervention; to authorize an appropriation and expenditure of \$500,000.00 within the Public Safety Initiatives subfund; and to declare an emergency. (\$500,000.00)

This item was approved on the Consent Agenda.

ENVIRONMENT: REMY, CHR. BARROSO DE PADILLA FAVOR HARDIN

- CA-54** [2258-2023](#) To authorize the Finance and Management Director to enter into a Universal Term Contract for the option to purchase 300 Gallon Refuse Containers with Tank Holding Corp. dba Snyder Industries Inc.; to authorize the expenditure of \$1.00; and to declare an emergency. (\$1.00).

This item was approved on the Consent Agenda.

ADMINISTRATION: REMY, CHR. BROWN DORANS HARDIN

- CA-55** [2041-2023](#) To authorize the Executive Director of the Civil Service Commission to modify the current contract with Mount Carmel Health Providers, Inc. for the administration of pre-employment physicals and cardiovascular stress testing of public safety recruits; to authorize the additional expenditure of \$70,000.00 from the General Fund (\$70,000.00).

This item was approved on the Consent Agenda.

- CA-56** [2134-2023](#) To amend the Management Compensation Plan, Ordinance No. 2713-2013, as amended, by amending Sections 4(D) and 5(E); and to declare an emergency.

This item was approved on the Consent Agenda.

FINANCE: HARDIN, CHR. BANKSTON REMY BARROSO DE PADILLA

- CA-57** [2065-2023](#) To authorize the Director of Finance and Management to correct the transactions for the Community Development Block Grant (CDBG) program and Housing Opportunities for Persons With AIDS (HOPWA) program funded by the U.S. Department of Housing and Urban Development (HUD), in the amounts of \$600.24, \$192,559.94, and \$312,445.77 (total of \$505,605.95); to authorize the transfer of \$312,445.77 within the General Government Grants Fund; to authorize the expenditure of \$312,445.77 from the General Government Grants Fund; to authorize the transfer of \$193,160.18 within the General Fund; to authorize the expenditure of \$193,160.18

from the General Fund; and to declare an emergency. (\$505,605.95)

This item was approved on the Consent Agenda.

CA-58 [2121-2023](#)

To authorize the Finance and Management Director, on behalf of the Fleet Management Division, to establish purchase orders with The Dexter Company (\$73,138.36) and Kueper North America (\$7,440.00) for the purchase of After Market Snow Plow Parts; to authorize the expenditure of \$80,578.36 from the Fleet Management Operating Fund; and to declare an emergency. (\$80,578.36)

This item was approved on the Consent Agenda.

CA-59 [2122-2023](#)

To authorize the Finance and Management Director, on behalf of the Fleet Management Division, to establish purchase orders with Grimco Inc and Hyatt's Graphic Supply Co. Inc, for the purchase of Gerber and 3M films and foils; and to authorize the expenditure of \$69,376.95 from 2023 Fleet Purchase Plan (ACPR002432); and to declare an emergency. (\$69,376.95)

This item was approved on the Consent Agenda.

CA-60 [2125-2023](#)

To formally accept certain real estate conveyed to the City that is being used for various public purposes; and to authorize the directors of the Departments of Public Utilities, Public Service, Finance and Management, Development, and Recreation and Parks to enter into any necessary agreements, as approved by the City Attorney's Office, in order to address any real estate tax or assessment issues. (\$0.00)

This item was approved on the Consent Agenda.

CA-61 [2150-2023](#)

To authorize the Director of the Department of Finance and Management to modify a contract with Booth Management Consulting, LLC, to provide subrecipient monitoring, technical assistance, and training related to the City's administration of Federal Grant Awards; to authorize the appropriation and expenditure of \$8,841.25 from the Community Development Block Grant Fund; to authorize the transfer and expenditure of \$28,780.00 from the Emergency Rental Assistance fund and \$269,575.00 from the Recovery Fund; and to declare an emergency (\$307,196.25).

This item was approved on the Consent Agenda.

CA-62 [2151-2023](#)

To authorize the Finance and Management Director to enter into a Universal Term Contract for the option to purchase Oils, Greases, and Fluids with Glockner Oil Company, Inc.; and to authorize the expenditure of \$1.00. (\$1.00)

This item was approved on the Consent Agenda.

CA-63 [2155-2023](#)

To authorize the Finance and Management Director to enter into

Universal Term Contracts for the option to purchase Aftermarket Truck Parts with Rush Truck Centers of Ohio, Inc. and Fyda Freightliner Columbus, Inc.; and to authorize the expenditure of \$2.00. (\$2.00)

This item was approved on the Consent Agenda.

CA-64 [2224-2023](#)

To authorize the City Auditor to enter into contract with Johnson Mirmiran & Thompson, Inc. dba JMT Technology Group; to authorize the expenditure of \$470,000.00 from the Auditor Bond Fund. (\$470,000.00); and to declare an emergency.

This item was approved on the Consent Agenda.

CA-65 [2263-2023](#)

To authorize the Director of the Department of Finance and Management to issue a purchase order to Heritage Fire Equipment for body repairs for Fire Engine 24 in accordance with the universal term contract established for such purpose; to authorize the expenditure of \$109,092.50 from the Safety Bond Fund; and to declare an emergency. (\$109,092.50)

This item was approved on the Consent Agenda.

CA-66 [2264-2023](#)

To authorize a transfer between projects within the Safety Bond Fund and to amend the 2023 Capital Improvements Budget; to authorize the Director of Finance and Management to issue a purchase order to The WW Williams Company LLC for engine replacement services for Fire Engine XE-25 in accordance with the universal term contract established for such purpose; to authorize the expenditure of \$47,978.91 from the Safety Bond Fund; and to declare an emergency. (\$47,978.91)

This item was approved on the Consent Agenda.

CA-67 [2270-2023](#)

To authorize the Director of the Department of Finance and Management to execute a Fifth Amendment to Lease Agreement with KA Restaurant Concepts LLC to reduce the rent during the period of the construction project to replace the Scioto Mile Fountain; and to declare an emergency.

This item was approved on the Consent Agenda.

APPOINTMENTS

CA-68 [A0156-2023](#)

Re-appointment of Kathy Owens, Director, Department of Finance and Management, City of Columbus, 90 West Broad Street, Columbus, OH 43215, to serve on the Solid Waste Authority of Central Ohio Board of Trustees, with a new term expiration date of June 20, 2025 (biography attached).

This item was approved on the Consent Agenda.

- CA-69** [A0157-2023](#) Reappointment of Darci Congrove, CPA, Managing Director, GBQ Partners LLC, 230 West State Street, Suite 700, Columbus, Ohio 43215, to serve on the Columbus-Franklin County Finance Authority Board of Trustees, with a new term expiration date of April 30, 2027 (biography attached).
- This item was approved on the Consent Agenda.**
- CA-70** [A0158-2023](#) Appointment of Michael S. Brown, Chief of Staff to the Council President, 90 West Broad Street, Columbus, Ohio, 43215, to serve on the Columbus Zoological Park Association Board of Directors, with a new term expiration date of July 31, 2026 (profile attached).
- This item was approved on the Consent Agenda.**
- CA-71** [A0159-2023](#) Appointment of Kathy A. Owens, Director, Columbus Department of Finance and Management, 90 West Broad Street, Columbus, Ohio 43215, to serve on the Columbus Zoological Park Association Board of Directors, with a new term expiration date of July 31, 2026 (biography attached).
- This item was approved on the Consent Agenda.**
- CA-72** [A0160-2023](#) Appointment of Pamela Hykes O'Grady, Deputy Director, Department of Technology, City of Columbus, to serve on the Columbus Zoological Park Association Board of Directors, with a new term expiration date of July 31, 2026 (biography attached).
- This item was approved on the Consent Agenda.**
- CA-73** [A0161-2023](#) Appointment of Kenneth C. Paul, Chief of Staff, Office of the Mayor, 90 West Broad Street, Columbus, Ohio 43215, to serve on the Columbus Zoological Park Association Board of Directors, with a new term expiration date of July 31, 2026 (biography attached).
- This item was approved on the Consent Agenda.**
- CA-74** [A0162-2023](#) Reappointment of Jeff Edwards, President, CEO & Chairman, Installed Building Products, to serve on the Columbus Downtown Development Corporation Board of Directors, with a term expiration date of July 8, 2026 (biography attached).
- This item was approved on the Consent Agenda.**
- CA-75** [A0163-2023](#) Reappointment of Alex Fischer, Former President and CEO, The Columbus Partnership, to serve on the Columbus Downtown Development Corporation Board of Directors, with a term expiration date of July 8, 2026 (profile attached).
- This item was approved on the Consent Agenda.**
- CA-76** [A0164-2023](#) Reappointment of Matt Scantland, Founder and CEO, AndHealth, to

serve on the Columbus Downtown Development Corporation Board of Directors, with a new term expiration date of July 8, 2026 (profile attached).

This item was approved on the Consent Agenda.

CA-77 [A0165-2023](#)

Reappointment of Dr. Sharon Parsons, 2862 East Main Street, Columbus, Ohio, 43209, to serve on the OneOhio Region 1 Board of Governance, representing the Central Ohio Mayors and Managers Association, with a new term expiration date of July 25, 2027 (biography attached).

This item was approved on the Consent Agenda.

Approval of the Consent Agenda

A motion was made by Emmanuel V. Remy, seconded by Mitchell Brown, including all the preceding items marked as having been approved on the Consent Agenda. The motion carried by the following vote

Affirmative: 7 - Nicholas Bankston, Lourdes Barroso De Padilla, Mitchell Brown, Rob Dorans, Shayla Favor, Emmanuel Remy, and Shannon Hardin

SR EMERGENCY, POSTPONED AND 2ND READING OF 30-DAY LEGISLATION

SMALL & MINORITY BUSINESS: BANKSTON, CHR. REMY BARROSO DE PADILLA HARDIN

SR-1 [2044-2023](#)

To authorize the Director of Development to enter into a contract with Columbus Compact Corporation, a non-profit organization, for business advising services for the Downtown Commercial Marketplace Program, to authorize an appropriation and expenditure of up to \$150,000.00 within the Jobs Growth subfund. (\$150,000.00)

Sponsors: Nicholas Bankston

A motion was made by Nicholas Bankston, seconded by Emmanuel V. Remy, that this Ordinance be Approved. The motion carried by the following vote:

Affirmative: 7 - Nicholas Bankston, Lourdes Barroso De Padilla, Mitchell Brown, Rob Dorans, Shayla Favor, Emmanuel Remy, and Shannon Hardin

[2187-2023](#)

To authorize the Director of the Department of Development to enter into a grant agreement with Freedom Equity, Inc. in an amount up to \$1,500,000.00 for a micro loan program to support small minority businesses; to authorize the transfer of \$1,500,000.00 between the Citywide Account and the Department of Development; to authorize the expenditure of up to \$1,500,000.00 from the General Fund; and to authorize the advancement of funds on a pre-determined schedule during the term of the agreement. (\$1,500,000.00)

A motion was made by Emmanuel V. Remy, seconded by Rob Dorans, to Waive

the 2nd Reading. The motion carried by the following vote:

Affirmative: 7 - Nicholas Bankston, Lourdes Barroso De Padilla, Mitchell Brown, Rob Dorans, Shayla Favor, Emmanuel Remy, and Shannon Hardin

A motion was made by Nicholas Bankston, seconded by Lourdes Barroso De Padilla, that this Ordinance be Approved. The motion carried by the following vote:

Affirmative: 7 - Nicholas Bankston, Lourdes Barroso De Padilla, Mitchell Brown, Rob Dorans, Shayla Favor, Emmanuel Remy, and Shannon Hardin

TECHNOLOGY: BANKSTON, CHR. DORANS BROWN HARDIN

2147-2023

To authorize the Director of the Department of Technology to renew an agreement with Columbus Fibernet, LLC (CFN) for fiber optic cable maintenance services for the CFN fiber duct system in support of the City's fiber optic infrastructure; and to authorize the expenditure of \$82,746.45 from the Department of Technology, Information Services Division, Information Services Operating Fund. (\$82,746.45)

A motion was made by Emmanuel V. Remy, seconded by Rob Dorans, to Waive the 2nd Reading. The motion carried by the following vote:

Affirmative: 7 - Nicholas Bankston, Lourdes Barroso De Padilla, Mitchell Brown, Rob Dorans, Shayla Favor, Emmanuel Remy, and Shannon Hardin

A motion was made by Nicholas Bankston, seconded by Emmanuel V. Remy, that this Ordinance be Approved. The motion carried by the following vote:

Affirmative: 7 - Nicholas Bankston, Lourdes Barroso De Padilla, Mitchell Brown, Rob Dorans, Shayla Favor, Emmanuel Remy, and Shannon Hardin

2266-2023

To appropriate \$610,000.00 to the Department of Technology, Information Services Division, from the unappropriated cash balance of the Information Services Operating Fund; to authorize the Director of the Department of Technology to enter into a non-profit services contract with Smart Columbus LLC in an amount up to \$610,000.00 to support the ongoing efforts and work of the Smart Columbus organization; and to authorize the expenditure of \$610,000.00 from the Information Services Operating Fund. (\$610,000.00)

A motion was made by Emmanuel V. Remy, seconded by Rob Dorans, to Waive the 2nd Reading. The motion carried by the following vote:

Affirmative: 7 - Nicholas Bankston, Lourdes Barroso De Padilla, Mitchell Brown, Rob Dorans, Shayla Favor, Emmanuel Remy, and Shannon Hardin

A motion was made by Nicholas Bankston, seconded by Mitchell Brown, that this Ordinance be Approved. The motion carried by the following vote:

Affirmative: 7 - Nicholas Bankston, Lourdes Barroso De Padilla, Mitchell Brown, Rob Dorans, Shayla Favor, Emmanuel Remy, and Shannon Hardin

ECONOMIC DEVELOPMENT: BANKSTON, CHR. REMY DORANS HARDIN

[1831-2023](#)

To authorize the Director of the Department of Development to enter into a grant agreement with St. Mary School, Inc.; to authorize the expenditure of \$500,000.00 from the Development Taxable Bond Fund and to allow for expenditures prior to the Purchase Order. (\$500,000.00)

A motion was made by Emmanuel V. Remy, seconded by Rob Dorans, to Waive the 2nd Reading. The motion carried by the following vote:

Affirmative: 7 - Nicholas Bankston, Lourdes Barroso De Padilla, Mitchell Brown, Rob Dorans, Shayla Favor, Emmanuel Remy, and Shannon Hardin

A motion was made by Nicholas Bankston, seconded by Mitchell Brown, that this Ordinance be Approved. The motion carried by the following vote:

Affirmative: 7 - Nicholas Bankston, Lourdes Barroso De Padilla, Mitchell Brown, Rob Dorans, Shayla Favor, Emmanuel Remy, and Shannon Hardin

[1833-2023](#)

To authorize the Director of the Department of Development to enter into a Grant Agreement with Elevate Northland in an amount of up to \$500,000.00, to advance the planning, design and construction of new community center space to continue providing training and business incubation assistance to the Northland community; and to authorize the expenditure of \$500,000.00 from the Development Taxable Bond Fund and to allow for expenditures prior to the Purchase Order. (\$500,000.00)

A motion was made by Emmanuel V. Remy, seconded by Rob Dorans, to Waive the 2nd Reading. The motion carried by the following vote:

Affirmative: 7 - Nicholas Bankston, Lourdes Barroso De Padilla, Mitchell Brown, Rob Dorans, Shayla Favor, Emmanuel Remy, and Shannon Hardin

A motion was made by Nicholas Bankston, seconded by Mitchell Brown, that this Ordinance be Approved. The motion carried by the following vote:

Affirmative: 7 - Nicholas Bankston, Lourdes Barroso De Padilla, Mitchell Brown, Rob Dorans, Shayla Favor, Emmanuel Remy, and Shannon Hardin

[2186-2023](#)

To authorize the Director of the Department of Development to enter into a Grant Agreement with Ronald McDonald House Charities of Central Ohio, Inc., in an amount not to exceed \$1,000,000.00, to advance the planning, design and construction of the new expansion to their facility located at 711 E. Livingston Avenue across from Nationwide Children's Hospital; and to authorize the expenditure of \$1,000,000.00 from the Development Taxable Bond Fund. (\$1,000,000.00)

A motion was made by Emmanuel V. Remy, seconded by Rob Dorans, to Waive the 2nd Reading. The motion carried by the following vote:

Affirmative: 7 - Nicholas Bankston, Lourdes Barroso De Padilla, Mitchell Brown, Rob Dorans, Shayla Favor, Emmanuel Remy, and Shannon Hardin

A motion was made by Nicholas Bankston, seconded by Emmanuel V. Remy, that this Ordinance be Approved. The motion carried by the following vote:

Affirmative: 7 - Nicholas Bankston, Lourdes Barroso De Padilla, Mitchell Brown, Rob Dorans, Shayla Favor, Emmanuel Remy, and Shannon Hardin

[2228-2023](#)

This legislation is to authorize the Director of the Department of Development to amend the City of Columbus Community Reinvestment Area Agreement for the third time to right size the job creation commitment based on the revised reduced amount of square footage of the project per the Tax Incentive Review Council ("TIRC") recommendations, and to determine the current Carryforward Amount.

A motion was made by Emmanuel V. Remy, seconded by Rob Dorans, to Waive the 2nd Reading. The motion carried by the following vote:

Affirmative: 7 - Nicholas Bankston, Lourdes Barroso De Padilla, Mitchell Brown, Rob Dorans, Shayla Favor, Emmanuel Remy, and Shannon Hardin

A motion was made by Nicholas Bankston, seconded by Mitchell Brown, that this Ordinance be Approved. The motion carried by the following vote:

Affirmative: 7 - Nicholas Bankston, Lourdes Barroso De Padilla, Mitchell Brown, Rob Dorans, Shayla Favor, Emmanuel Remy, and Shannon Hardin

[2305-2023](#)

To authorize the Director of the Department of Development to enter into a contract with Priscilla Tyson Consulting, LLC to assist in the completion and opening of the Poindexter Village Museum and Cultural Center (PVMCC); to authorize the appropriation and expenditure within the Neighborhood Initiatives subfund; and to waive the competitive bidding provisions of the Columbus City Codes. (\$100,000.00)

Sponsors: Shannon G. Hardin, Mitchell Brown and Nicholas Bankston

A motion was made by Emmanuel V. Remy, seconded by Rob Dorans, to Waive the 2nd Reading. The motion carried by the following vote:

Affirmative: 7 - Nicholas Bankston, Lourdes Barroso De Padilla, Mitchell Brown, Rob Dorans, Shayla Favor, Emmanuel Remy, and Shannon Hardin

A motion was made by Nicholas Bankston, seconded by Mitchell Brown, that this Ordinance be Approved. The motion carried by the following vote:

Affirmative: 7 - Nicholas Bankston, Lourdes Barroso De Padilla, Mitchell Brown, Rob Dorans, Shayla Favor, Emmanuel Remy, and Shannon Hardin

PUBLIC SERVICE & TRANSPORTATION: BARROSO DE PADILLA, CHR. FAVOR BANKSTON HARDIN

SR-2 [2081-2023](#)

To amend the 2023 Capital Improvement budget; to authorize and direct the City Auditor to appropriate and transfer funds from the Special Income Tax Fund to the Streets and Highways Bond Fund; to appropriate funds within the Streets and Highways Bond Fund; to authorize the Director of Public Service to enter into contract with Strawser Paving Company for the Resurfacing - 2023 Project 2; to authorize the expenditure of up to \$13,056,064.97 from the Streets

and Highways Bonds Fund for the project; and to declare an emergency. (\$13,056,064.97)

A motion was made by Lourdes Barroso De Padilla, seconded by Mitchell Brown, that this Ordinance be Approved. The motion carried by the following vote:

Affirmative: 7 - Nicholas Bankston, Lourdes Barroso De Padilla, Mitchell Brown, Rob Dorans, Shayla Favor, Emmanuel Remy, and Shannon Hardin

NEIGHBORHOODS AND IMMIGRANT, REFUGEE, AND MIGRANT AFFAIRS: BARROSO DE PADILLA, CHR. DORANS REMY HARDIN

SR-3 [2189-2023](#)

To authorize the transfer of appropriation between object classes within the general fund to align with the City of Columbus Grant Guidance; and to declare an emergency. (\$1,015,000.00).

A motion was made by Lourdes Barroso De Padilla, seconded by Mitchell Brown, that this Ordinance be Approved. The motion carried by the following vote:

Affirmative: 7 - Nicholas Bankston, Lourdes Barroso De Padilla, Mitchell Brown, Rob Dorans, Shayla Favor, Emmanuel Remy, and Shannon Hardin

RULES & REFERENCE: HARDIN, CHR. BROWN REMY FAVOR

BARROSO DE PADILLA

SR-20 [1984-2023](#)

To enact, amend, and repeal various sections and chapters of Title 9 of the Columbus City Codes to improve operational efficiencies, provide better services to the public and provide for better enforcement of Title 9 violations through civil penalties and fines.

Sponsors: Lourdes Barroso De Padilla

A motion was made by Lourdes Barroso De Padilla, seconded by Nicholas Bankston, that this Ordinance be Approved. The motion carried by the following vote:

Affirmative: 7 - Nicholas Bankston, Lourdes Barroso De Padilla, Mitchell Brown, Rob Dorans, Shayla Favor, Emmanuel Remy, and Shannon Hardin

SR-21 [2053-2023](#)

To enact, amend, and repeal various sections of Chapter 219, Chapter 919, and Title 21 of the Columbus City Codes to improve operational efficiencies by updating the division's name, to give the director the ability to promulgate rules and regulations related to shared mobility devices, and to establish the collection of correct vehicle information, mobility zone number, and any other information required to complete a parking transaction.

Sponsors: Lourdes Barroso De Padilla

A motion was made by Lourdes Barroso De Padilla, seconded by Mitchell

Brown, that this Ordinance be Approved. The motion carried by the following vote:

Affirmative: 7 - Nicholas Bankston, Lourdes Barroso De Padilla, Mitchell Brown, Rob Dorans, Shayla Favor, Emmanuel Remy, and Shannon Hardin

RECESS

A motion was made by Emmanuel V. Remy, seconded by Rob Dorans, to Recess the Regular Meeting. The motion carried by the following vote:

Affirmative: 7 - Nicholas Bankston, Lourdes Barroso De Padilla, Mitchell Brown, Rob Dorans, Shayla Favor, Emmanuel Remy, and Shannon Hardin

RECESSED AT 6:29 P.M.

RECONVENE

A motion was made by Rob Dorans, seconded by Shayla Favor, to Reconvene the Regular Meeting. The motion carried by the following vote:

Affirmative: 7 - Nicholas Bankston, Lourdes Barroso De Padilla, Mitchell Brown, Rob Dorans, Shayla Favor, Emmanuel Remy, and Shannon Hardin

RECONVENED AT 6:59 P.M.

RECREATION & PARKS: BROWN, CHR. DORANS BANKSTON HARDIN

SR-4 [2097-2023](#) To authorize the Director of the Department of Recreation and Parks to enter into contract with GTC for the HVAC Equipment Upgrades 2020-2022 Project; to authorize the transfer of \$3,976,500.00 within the Recreation and Parks Voted Bond Fund, to authorize the amendment of the 2023 Capital Improvements Budget; and to authorize the expenditure of \$3,976,500.00 from the Recreation and Parks Voted Bond Fund. (\$3,976,500.00)

A motion was made by Nicholas Bankston, seconded by Shayla Favor, that this Ordinance be Approved. The motion carried by the following vote:

Affirmative: 7 - Nicholas Bankston, Lourdes Barroso De Padilla, Mitchell Brown, Rob Dorans, Shayla Favor, Emmanuel Remy, and Shannon Hardin

SR-5 [2124-2023](#) To authorize the appropriation of \$1,797,205.00 within the CDBG Fund in accordance with the 2020 Amended Annual Action Plan; to authorize an expenditure correction of \$1,797,205.00 from the Recreation and Parks Voted Bond Fund to the CDBG Fund for the Glenwood and Windsor Pool Replacements Project; and to declare an emergency. (\$1,797,205.00)

A motion was made by Mitchell Brown, seconded by Nicholas Bankston, that this Ordinance be Approved. The motion carried by the following vote:

Affirmative: 7 - Nicholas Bankston, Lourdes Barroso De Padilla, Mitchell Brown, Rob Dorans, Shayla Favor, Emmanuel Remy, and Shannon Hardin

CA-27 [1552-2023](#)

To authorize the Director of Recreation and Parks to enter into a non-profit grant agreement with Gladden Community House in support of summer programming to youth; to authorize an appropriation within the Recreation and Parks Operating and Extension Fund; to authorize the expenditure of \$50,000.00 from the Recreation and Parks Operating Fund. (\$50,000.00)

A motion was made by Mitchell Brown, seconded by Emmanuel V. Remy, that this Ordinance be Amended as submitted to the Clerk. The motion carried by the following vote:

Abstained: 2 - Nicholas Bankston, and Shayla Favor

Affirmative: 5 - Lourdes Barroso De Padilla, Mitchell Brown, Rob Dorans, Emmanuel Remy, and Shannon Hardin

A motion was made by Mitchell Brown, seconded by Emmanuel V. Remy, that this Ordinance be Approved as Amended. The motion carried by the following vote:

Abstained: 1 - Nicholas Bankston

Affirmative: 6 - Lourdes Barroso De Padilla, Mitchell Brown, Rob Dorans, Shayla Favor, Emmanuel Remy, and Shannon Hardin

EDUCATION: BROWN, CHR. FAVOR BARROSO DE PADILLA HARDIN

SR-6 [1931-2023](#)

To authorize and direct the Executive Director of the Mayor's Office of Education to enter into contracts with high-quality pre-kindergarten organizations, selected via a competitive application process, to provide educational services; and to authorize the expenditure not to exceed \$5,931,325.00 from the General Fund; (\$5,931,325.00)

A motion was made by Mitchell Brown, seconded by Emmanuel V. Remy, that this Ordinance be Approved. The motion carried by the following vote:

Abstained: 2 - Nicholas Bankston, and Shayla Favor

Affirmative: 5 - Lourdes Barroso De Padilla, Mitchell Brown, Rob Dorans, Emmanuel Remy, and Shannon Hardin

[2148-2023](#)

To authorize the Director of the Office of Education to enter into a contract with the Crane Center for Early Childhood Research and Policy at The Ohio State University to implement Ready4Success, a screening and improvement strategy, and Read It Again, Read it Again - Math, and to provide mid-year student assessment; and to authorize the expenditure of \$491,000.00 from the General Fund. (\$491,000.00)

A motion was made by Emmanuel V. Remy, seconded by Rob Dorans, to Waive the 2nd Reading. The motion carried by the following vote:

Abstained: 1 - Shayla Favor

Affirmative: 6 - Nicholas Bankston, Lourdes Barroso De Padilla, Mitchell Brown, Rob Dorans, Emmanuel Remy, and Shannon Hardin

A motion was made by Mitchell Brown, seconded by Lourdes Barroso De Padilla, that this Ordinance be Approved. The motion carried by the following vote:

Abstained: 1 - Shayla Favor

Affirmative: 6 - Nicholas Bankston, Lourdes Barroso De Padilla, Mitchell Brown, Rob Dorans, Emmanuel Remy, and Shannon Hardin

PUBLIC UTILITIES: DORANS, CHR. BANKSTON REMY HARDIN

[1880-2023](#)

To authorize the Director of Public Utilities to enter into a service agreement in accordance with the relevant provisions of Chapter 329 of the City Code pertaining to waiver of competitive bidding, with The Ohio State University, Office of Sponsored Programs, for the NPDES Stormwater and Clintonville Blueprint Monitoring Project for the Division of Sewerage and Drainage, Stormwater and Regulatory Management Section; and to authorize the expenditure of \$275,000.00 from the Storm Sewer Operating Fund. (\$275,000.00)

A motion was made by Emmanuel V. Remy, seconded by Rob Dorans, to Waive the 2nd Reading. The motion carried by the following vote:

Abstained: 1 - Shayla Favor

Affirmative: 6 - Nicholas Bankston, Lourdes Barroso De Padilla, Mitchell Brown, Rob Dorans, Emmanuel Remy, and Shannon Hardin

A motion was made by Rob Dorans, seconded by Lourdes Barroso De Padilla, that this Ordinance be Approved. The motion carried by the following vote:

Abstained: 1 - Shayla Favor

Affirmative: 6 - Nicholas Bankston, Lourdes Barroso De Padilla, Mitchell Brown, Rob Dorans, Emmanuel Remy, and Shannon Hardin

WORKFORCE DEVELOPMENT: DORANS, CHR. FAVOR BROWN HARDIN

[2276-2023](#)

To authorize the City Clerk to enter into contract with Wentz, McInerney, Peifer & Petroff, LLC for legal and educational services in support of the work of the Community Benefits Agreement Advisory Committee; to authorize an appropriation and expenditure of \$20,000.00 from the Job Growth subfund. (\$20,000.00)

Sponsors: Rob Dorans

A motion was made by Emmanuel V. Remy, seconded by Rob Dorans, to Waive the 2nd Reading. The motion carried by the following vote:

Affirmative: 7 - Nicholas Bankston, Lourdes Barroso De Padilla, Mitchell Brown, Rob Dorans, Shayla Favor, Emmanuel Remy, and Shannon Hardin

A motion was made by Rob Dorans, seconded by Mitchell Brown, that this Ordinance be Approved. The motion carried by the following vote:

Affirmative: 7 - Nicholas Bankston, Lourdes Barroso De Padilla, Mitchell Brown, Rob Dorans, Shayla Favor, Emmanuel Remy, and Shannon Hardin

RULES & REFERENCE: HARDIN, CHR. BROWN REMY FAVOR

DORANS

SR-22 [1871-2023](#) To repeal and amend various sections in Title 33 of the Columbus City Codes, entitled "Zoning Code," in order to update and modernize terms, correct typographic mistakes, to clarify that automobile maintenance and repair is an allowable use in the M-1 and M-2 Manufacturing zoning districts, and to allow one- and two-units dwellings in apartment residential zoning districts.

Sponsors: Rob Dorans

A motion was made by Rob Dorans, seconded by Mitchell Brown, that this Ordinance be Approved. The motion carried by the following vote:

Affirmative: 7 - Nicholas Bankston, Lourdes Barroso De Padilla, Mitchell Brown, Rob Dorans, Shayla Favor, Emmanuel Remy, and Shannon Hardin

SR-23 [1872-2023](#) To repeal and replace various sections in Chapter 3312, "Off-Street Parking and Loading" of the Columbus City Codes in order to update and modernize the minimum number of off-street parking and loading spaces required by code, and to update overall off-street parking and loading space regulations.

Sponsors: Rob Dorans

A motion was made by Rob Dorans, seconded by Lourdes Barroso De Padilla, that this Ordinance be Approved. The motion carried by the following vote:

Affirmative: 7 - Nicholas Bankston, Lourdes Barroso De Padilla, Mitchell Brown, Rob Dorans, Shayla Favor, Emmanuel Remy, and Shannon Hardin

HOUSING: FAVOR, CHR. BROWN BANKSTON HARDIN

SR-7 [2011-2023](#) To amend Ordinance No. 3296-2022 to authorize the additional expenditure of \$1,250,000.00 to Columbus Housing Partnership, Inc., (aka "Homeport") for the Easton Place Homes Phase II development (the "Project"); to amend the 2023 Capital Improvement Budget; to authorize the City Auditor to transfer funds within the Affordable Housing Bond Fund; to authorize a third amendment to the Bond Funded Grant Agreement; to authorize the filing of a restrictive

covenant on the Project; to authorize the assignment of some or all duties and responsibilities under the Bond Funded Grant Agreement to the project owner; and to declare an emergency. (\$1,250,000.00)

A motion was made by Shayla Favor, seconded by Emmanuel V. Remy, that this Ordinance be Approved. The motion carried by the following vote:

Affirmative: 7 - Nicholas Bankston, Lourdes Barroso De Padilla, Mitchell Brown, Rob Dorans, Shayla Favor, Emmanuel Remy, and Shannon Hardin

RULES & REFERENCE: HARDIN, CHR. BROWN REMY FAVOR

FAVOR

SR-24 [2108-2023](#) To amend Chapters 4501 and 4551 of the Columbus City Codes to ensure that no operator shall refuse to accept tender on behalf of a tenant on the basis that the tender was proffered by a person other than the tenant.

Sponsors: Shayla Favor

A motion was made by Shayla Favor, seconded by Emmanuel V. Remy, that this Ordinance be Approved. The motion carried by the following vote:

Affirmative: 7 - Nicholas Bankston, Lourdes Barroso De Padilla, Mitchell Brown, Rob Dorans, Shayla Favor, Emmanuel Remy, and Shannon Hardin

SR-25 [2109-2023](#) To amend Chapter 4551 of the Columbus City Codes to ensure that occupants in residential rental properties are afforded the right to assert tender of rent as an affirmative defense to an eviction action filed on the basis of nonpayment of rent.

Sponsors: Shayla Favor

A motion was made by Shayla Favor, seconded by Rob Dorans, that this Ordinance be Amended as submitted to the Clerk. The motion carried by the following vote:

Affirmative: 7 - Nicholas Bankston, Lourdes Barroso De Padilla, Mitchell Brown, Rob Dorans, Shayla Favor, Emmanuel Remy, and Shannon Hardin

A motion was made by Shayla Favor, seconded by Rob Dorans, that this Ordinance be Approved as Amended. The motion carried by the following vote:

Affirmative: 7 - Nicholas Bankston, Lourdes Barroso De Padilla, Mitchell Brown, Rob Dorans, Shayla Favor, Emmanuel Remy, and Shannon Hardin

HOUSING: FAVOR, CHR. BROWN BANKSTON HARDIN

SR-8 [2177-2023](#) To authorize the Director of the Department of Development to execute Grant Agreements with numerous not-for-profit, social service agencies, in an amount up to \$4,396,924.32, of U.S. Department of Treasury Emergency Rental Assistance 2 (ERA 2) funds to eligible

recipients as part of the department's ERA 2 Strategy; to authorize an agreement start date of August 1, 2023; to authorize the payment of eligible expenses through September 30, 2025; to authorized the advancement of funds on a pre-determined schedule during the term of the agreement; to authorized the expenditure of up to \$4,396,924.32 from the Emergency Rental Assistance 2 Fund; and to declare an emergency. (\$4,396,924.32)

A motion was made by Shayla Favor, seconded by Emmanuel V. Remy, that this Ordinance be Approved. The motion carried by the following vote:

Affirmative: 7 - Nicholas Bankston, Lourdes Barroso De Padilla, Mitchell Brown, Rob Dorans, Shayla Favor, Emmanuel Remy, and Shannon Hardin

SR-9 [2089-2023](#)

To authorize the Director of the Department of Development to enter into a not-for-profit service agreement with the Legal Aid Society of Columbus in an amount up to \$1,500,000.00 in support of the Tenant Advocacy Project (TAP) to provide legal representation to residents facing an eviction; to authorize an appropriation and expenditure within the Public Safety Initiative subfund; and to declare an emergency. (\$1,500,000.00)

Sponsors: Shayla Favor

A motion was made by Shayla Favor, seconded by Emmanuel V. Remy, that this Ordinance be Approved. The motion carried by the following vote:

Affirmative: 7 - Nicholas Bankston, Lourdes Barroso De Padilla, Mitchell Brown, Rob Dorans, Shayla Favor, Emmanuel Remy, and Shannon Hardin

SR-10 [2146-2023](#)

To authorize the Director of the Department of Development to enter into a grant agreement with Columbus Housing Partnership Inc, dba Homeport, in support of the Homeownership fund which will provide targeted down payment assistance and housing counseling services; to authorize an appropriation and expenditure within the Easton TIF Fund; and to declare an emergency. (\$350,000.00)

Sponsors: Shayla Favor and Lourdes Barroso De Padilla

A motion was made by Shayla Favor, seconded by Emmanuel V. Remy, that this Ordinance be Approved. The motion carried by the following vote:

Affirmative: 7 - Nicholas Bankston, Lourdes Barroso De Padilla, Mitchell Brown, Rob Dorans, Shayla Favor, Emmanuel Remy, and Shannon Hardin

SR-11 [2156-2023](#)

To authorize the City Attorney to modify an existing contract with Columbus Next Generation Corporation; to authorize an appropriation and expenditure within the general fund; and to declare an emergency. (\$500,000.00)

Sponsors: Mitchell Brown

A motion was made by Mitchell Brown, seconded by Emmanuel V. Remy, that this Ordinance be Approved. The motion carried by the following vote:

Abstained: 1 - Shayla Favor

Affirmative: 6 - Nicholas Bankston, Lourdes Barroso De Padilla, Mitchell Brown, Rob Dorans, Emmanuel Remy, and Shannon Hardin

[2268-2023](#)

To authorize the Director of Development to execute a Grant Agreement with Rebuilding Together Central Ohio dba ModCon Living, in an amount up to \$270,000.00 towards providing home repair services to residents of the North Central community; and to authorize an appropriation and expenditure of \$270,000.00 within the Neighborhood Initiatives Subfund; and to authorize reimbursement of expenses incurred prior to execution of the purchase order. (\$270,000.00)

Sponsors: Emmanuel V. Remy

A motion was made by Emmanuel V. Remy, seconded by Rob Dorans, to Waive the 2nd Reading. The motion carried by the following vote:

Affirmative: 7 - Nicholas Bankston, Lourdes Barroso De Padilla, Mitchell Brown, Rob Dorans, Shayla Favor, Emmanuel Remy, and Shannon Hardin

A motion was made by Shayla Favor, seconded by Emmanuel V. Remy, that this Ordinance be Approved. The motion carried by the following vote:

Affirmative: 7 - Nicholas Bankston, Lourdes Barroso De Padilla, Mitchell Brown, Rob Dorans, Shayla Favor, Emmanuel Remy, and Shannon Hardin

PUBLIC SAFETY: REMY, CHR. BARROSO DE PADILLA DORANS HARDIN

SR-12 [2167-2023](#)

To authorize the Director of the Department of Public Safety to enter into a contract with Crowd and Conflict Management Ltd. to implement the first phase of "ENABLE Columbus," a project that aims to develop research expertise and enhance crowd management strategies, foster dialogue between police and demonstrators and safeguard First Amendment rights in the City of Columbus; to authorize the expenditure of \$94,200.00 from the General Fund; to waive the competitive bidding provisions of the Columbus City Codes; and to declare an emergency. (\$94,200.00)

A motion was made by Emmanuel V. Remy, seconded by Shayla Favor, that this Ordinance be Approved. The motion carried by the following vote:

Affirmative: 7 - Nicholas Bankston, Lourdes Barroso De Padilla, Mitchell Brown, Rob Dorans, Shayla Favor, Emmanuel Remy, and Shannon Hardin

SR-13 [2231-2023](#)

To authorize the Director of the Department of Public Safety to enter into contract with Motorola Solutions, DBA Vigilant Solutions, for the purchase of commercial license subscriptions for the Investigative Data Platform; to waive the competitive bidding provisions of the Columbus City Codes; to authorize an expenditure of \$99,995.00 from the Law Enforcement Seizure Fund; and to declare an emergency

(\$99,995.00)

A motion was made by Emmanuel V. Remy, seconded by Mitchell Brown, that this Ordinance be Approved. The motion carried by the following vote:

Affirmative: 7 - Nicholas Bankston, Lourdes Barroso De Padilla, Mitchell Brown, Rob Dorans, Shayla Favor, Emmanuel Remy, and Shannon Hardin

[2242-2023](#)

To authorize the Finance and Management Director to associate all general budget reservations resulting from this ordinance with the appropriate Universal Term Contract Purchase Agreement with Brown Enterprise Solutions, LLC for the purchase of computers, monitors, and accessories, on behalf of the Department of Public Safety, Division of Support Services; to authorize the expenditure of \$179,303.12 from the Division of Support Services' general fund operating budget. (\$179,303.12)

A motion was made by Emmanuel V. Remy, seconded by Rob Dorans, to Waive the 2nd Reading. The motion carried by the following vote:

Affirmative: 7 - Nicholas Bankston, Lourdes Barroso De Padilla, Mitchell Brown, Rob Dorans, Shayla Favor, Emmanuel Remy, and Shannon Hardin

A motion was made by Emmanuel V. Remy, seconded by Mitchell Brown, that this Ordinance be Approved. The motion carried by the following vote:

Affirmative: 7 - Nicholas Bankston, Lourdes Barroso De Padilla, Mitchell Brown, Rob Dorans, Shayla Favor, Emmanuel Remy, and Shannon Hardin

ENVIRONMENT: REMY, CHR. BARROSO DE PADILLA FAVOR HARDIN

SR-14 [2185-2023](#)

To authorize the Director of the Department of Finance and Management to associate all General Budget reservations resulting from this ordinance with the appropriate Universal Term Contract Purchase Agreement for Front End and Rear End Loading Refuse Trucks for the Division of Refuse Collection with Ohio Machinery Co. dba Ohio Peterbilt; to authorize the expenditure of up to \$3,040,618.00 from the Refuse Bond Fund for these trucks; and to declare an emergency. (\$3,040,618.00)

A motion was made by Emmanuel V. Remy, seconded by Mitchell Brown, that this Ordinance be Approved. The motion carried by the following vote:

Affirmative: 7 - Nicholas Bankston, Lourdes Barroso De Padilla, Mitchell Brown, Rob Dorans, Shayla Favor, Emmanuel Remy, and Shannon Hardin

SR-15 [2191-2023](#)

To authorize the Director of Finance and Management to establish a purchase order with Fyda Freightliner Columbus, Inc. for purchase of one (1) Diesel-Powered Isuzu NPRHD Flatbed for the Division of Refuse Collection; to authorize the expenditure of up to \$94,378.00 from the Refuse Bond Fund; to authorize the waiver of the competitive bidding requirements of the Columbus City Code; and to declare an emergency. (\$94,378.00)

A motion was made by Emmanuel V. Remy, seconded by Nicholas Bankston, that this Ordinance be Approved. The motion carried by the following vote:

Affirmative: 7 - Nicholas Bankston, Lourdes Barroso De Padilla, Mitchell Brown, Rob Dorans, Shayla Favor, Emmanuel Remy, and Shannon Hardin

SR-16 [2202-2023](#)

To authorize the Director of Finance and Management to associate all General Budget reservations resulting from this ordinance with the appropriate Universal Term Contract Purchase Agreement for Knuckle Boom Waste Trucks for the Division of Refuse Collection with Ohio Machinery Company dba Ohio Peterbilt; to authorize the expenditure of up to \$1,987,487.00 from the Refuse Bond Fund for these trucks; and to declare an emergency. (\$1, 987,487.00)

A motion was made by Emmanuel V. Remy, seconded by Mitchell Brown, that this Ordinance be Approved. The motion carried by the following vote:

Affirmative: 7 - Nicholas Bankston, Lourdes Barroso De Padilla, Mitchell Brown, Rob Dorans, Shayla Favor, Emmanuel Remy, and Shannon Hardin

[2291-2023](#)

To authorize the City Clerk to enter into a grant agreement with the Garden Club Project; and to authorize an appropriation and expenditure within the Neighborhood Initiatives subfund. (\$10,000.00)

Sponsors: Mitchell Brown and Emmanuel V. Remy

A motion was made by Emmanuel V. Remy, seconded by Rob Dorans, to Waive the 2nd Reading. The motion carried by the following vote:

Affirmative: 7 - Nicholas Bankston, Lourdes Barroso De Padilla, Mitchell Brown, Rob Dorans, Shayla Favor, Emmanuel Remy, and Shannon Hardin

A motion was made by Emmanuel V. Remy, seconded by Rob Dorans, that this Ordinance be Approved. The motion carried by the following vote:

Affirmative: 7 - Nicholas Bankston, Lourdes Barroso De Padilla, Mitchell Brown, Rob Dorans, Shayla Favor, Emmanuel Remy, and Shannon Hardin

RULES & REFERENCE: HARDIN, CHR. BROWN REMY FAVOR

REMY

SR-26 [2275-2023](#)

To amend various sections in Chapters 501, 573, and 585 of the Columbus City Codes to allow flexibility in license renewal and alter frequency of regular meetings and quorum for the Vehicle for Hire Board and Mobile Food Vending Advisory Board.

Sponsors: Emmanuel V. Remy

A motion was made by Emmanuel V. Remy, seconded by Mitchell Brown, that this Ordinance be Approved. The motion carried by the following vote:

Affirmative: 7 - Nicholas Bankston, Lourdes Barroso De Padilla, Mitchell Brown, Rob Dorans, Shayla Favor, Emmanuel Remy, and Shannon Hardin

SR-27 [2297-2023](#) To amend the Columbus District Map to reflect any annexations to the city from 2021 through July 2023; to enact Chapter 104 of the Columbus City Codes, Administrative Code to memorialize the Columbus District Map within the Columbus City Codes; and to declare an emergency.

Sponsors: Emmanuel V. Remy and Shannon G. Hardin

A motion was made by Emmanuel V. Remy, seconded by Mitchell Brown, that this Ordinance be Approved. The motion carried by the following vote:

Affirmative: 7 - Nicholas Bankston, Lourdes Barroso De Padilla, Mitchell Brown, Rob Dorans, Shayla Favor, Emmanuel Remy, and Shannon Hardin

FINANCE: HARDIN, CHR. BANKSTON REMY BARROSO DE PADILLA

SR-17 [1990-2023](#) To authorize the Director of Finance and Management, on behalf of the Office of Construction Management, to enter into a construction contract with 2K General Company for the Health Department Expansion Renovation Project; to waive the provisions of Columbus City Codes, Chapter 378, in regards to approval by the Community Benefits Agreement Advisory Committee; to authorize transfers and expenditures up to \$21,493,900.00 within the Safety General Obligation Bond Fund, the Health General Obligations Bond Fund, and the Construction Management Capital Improvement Fund; and to authorize an amendment to the 2023 Capital Improvements Budget. (\$21,493,900.00)

A motion was made by Shannon G. Hardin, seconded by Emmanuel V. Remy, that this Ordinance be Approved. The motion carried by the following vote:

Affirmative: 7 - Nicholas Bankston, Lourdes Barroso De Padilla, Mitchell Brown, Rob Dorans, Shayla Favor, Emmanuel Remy, and Shannon Hardin

SR-18 [2219-2023](#) To authorize the City Auditor to modify and extend the contract with OnActuate Consulting and to modify the contract for Microsoft licensing and services through Dell Marketing LP; to waive the competitive bidding provisions of Columbus City Code to extend such contracts; to authorize the expenditure of \$450,000.00 from the Auditor Bond fund; and to declare an emergency. (\$450,000.00)

A motion was made by Shannon G. Hardin, seconded by Emmanuel V. Remy, that this Ordinance be Approved. The motion carried by the following vote:

Affirmative: 7 - Nicholas Bankston, Lourdes Barroso De Padilla, Mitchell Brown, Rob Dorans, Shayla Favor, Emmanuel Remy, and Shannon Hardin

SR-19 [2283-2023](#) To authorize the Director of Finance and Management to execute those documents necessary to acquire fee simple title and lesser interests to real property identified as Franklin County Tax Parcel 010-201154 located at 4285 Groves Road; to amend the 2023 Capital Improvement Budget; to authorize the transfer of cash and appropriation within the Construction Management Capital

Improvements Fund, Fund 7733; to authorize the expenditure of up to \$2,650,000.00 from the Construction Management Capital Improvements Fund, Fund No. 7733; and to declare an emergency. (\$2,650,000.00).

A motion was made by Shannon G. Hardin, seconded by Emmanuel V. Remy, that this Ordinance be Approved. The motion carried by the following vote:

Affirmative: 7 - Nicholas Bankston, Lourdes Barroso De Padilla, Mitchell Brown, Rob Dorans, Shayla Favor, Emmanuel Remy, and Shannon Hardin

RULES & REFERENCE: HARDIN, CHR. BROWN REMY FAVOR

HARDIN

SR-28 [2265-2023](#) To amend chapter 111 of the Columbus City Codes, pertaining to the ability of Council to hold virtual meetings.

Sponsors: Shannon G. Hardin

A motion was made by Shannon G. Hardin, seconded by Emmanuel V. Remy, that this Ordinance be Approved. The motion carried by the following vote:

Affirmative: 7 - Nicholas Bankston, Lourdes Barroso De Padilla, Mitchell Brown, Rob Dorans, Shayla Favor, Emmanuel Remy, and Shannon Hardin

RECESS

A motion was made by Emmanuel V. Remy, seconded by Rob Dorans, to Recess the Regular Meeting. The motion carried by the following vote:

Affirmative: 7 - Nicholas Bankston, Lourdes Barroso De Padilla, Mitchell Brown, Rob Dorans, Shayla Favor, Emmanuel Remy, and Shannon Hardin

RECESSED AT 8:40 P.M.

THE NEXT REGULAR MEETING OF COUNCIL WILL BE SEPTEMBER 11, 2023.



City of Columbus

Office of City Clerk
90 West Broad Street
Columbus OH
43215-9015
columbuscitycouncil.org

Minutes - Final Zoning Committee

Monday, July 31, 2023

6:30 PM

City Council Chambers, Rm 231

REGULAR MEETING NO.41 OF CITY COUNCIL (ZONING), JULY 31, 2023 AT 6:30 P.M. IN COUNCIL CHAMBERS.

ROLL CALL

Present 7 - Nicholas Bankston, Lourdes Barroso De Padilla, Mitchell Brown, Rob Dorans, Shayla Favor, Emmanuel Remy, and Shannon Hardin

READING AND DISPOSAL OF THE JOURNAL

A motion was made by Emmanuel V. Remy, seconded by Rob Dorans, to Dispense with the reading of the Journal and Approve. The motion carried by the following vote:

Affirmative: 7 - Nicholas Bankston, Lourdes Barroso De Padilla, Mitchell Brown, Rob Dorans, Shayla Favor, Emmanuel Remy, and Shannon Hardin

EMERGENCY, POSTPONED AND 2ND READING OF 30 DAY LEGISLATION

ZONING: DORANS, CHR. BANKSTON BARROSO DE PADILLA BROWN FAVOR REMY HARDIN

REZONINGS/AMENDMENTS

[2188-2023](#)

To rezone 210 WINNER AVE. (43203), being 3.12± acres located at the northeast corner of Hawthorne Avenue and Winner Avenue, From: ARLD, Apartment Residential District and I, Institutional District, To: CPD, Commercial Planned Development District and to declare an emergency.(Rezoning #Z23-019).

A motion was made by Rob Dorans, seconded by Emmanuel V. Remy, that this Ordinance be Amended to Emergency. The motion carried by the following vote:

Affirmative: 7 - Nicholas Bankston, Lourdes Barroso De Padilla, Mitchell Brown, Rob Dorans, Shayla Favor, Emmanuel Remy, and Shannon Hardin

A motion was made by Rob Dorans, seconded by Shayla Favor, that this Ordinance be Approved as Amended. The motion carried by the following vote:

Affirmative: 7 - Nicholas Bankston, Lourdes Barroso De Padilla, Mitchell Brown, Rob Dorans, Shayla Favor, Emmanuel Remy, and Shannon Hardin

[2210-2023](#)

To rezone 4300 ALKIRE RD. (43228), being 6.38± acres located on the north side of Alkire Road, 400± feet west side of Demorest Road, From: R, Rural District, To: L-AR-1, Limited Apartment Residential District (Rezoning #Z23-024).

A motion was made by Rob Dorans, seconded by Shayla Favor, that this Ordinance be Approved. The motion carried by the following vote:

Affirmative: 7 - Nicholas Bankston, Lourdes Barroso De Padilla, Mitchell Brown, Rob Dorans, Shayla Favor, Emmanuel Remy, and Shannon Hardin

[2215-2023](#)

To rezone 5200 WINCHESTER PIKE (43110), being 27.56± acres located on the north side of Winchester Pike, 1,650± feet east of Shannon Road, From: R, Rural District, To: L-M, Limited Manufacturing District (Rezoning #Z23-004).

A motion was made by Rob Dorans, seconded by Shayla Favor, that this Ordinance be Approved. The motion carried by the following vote:

Affirmative: 7 - Nicholas Bankston, Lourdes Barroso De Padilla, Mitchell Brown, Rob Dorans, Shayla Favor, Emmanuel Remy, and Shannon Hardin

VARIANCES

[2183-2023](#)

To grant a Variance from the provisions of Sections 3332.037, R-2F, Residential district; 3312.25, Maneuvering; 3312.21(D)(1), Landscaping and screening; 3321.05(B)(2), Vision clearance; 3332.05, Area district lot width requirements; 3332.14, R-2F area district requirements; 3332.18(D), Basis of computing area; 3332.19, Fronting; 3332.21, Building lines; 3332.25, Maximum side yards required; 3332.26, Minimum side yard permitted; 3332.27, Rear yard; and 3332.28(E), Private garage, of the Columbus City Codes; for the property located at 133 THURMAN AVE. (43206), to permit a non-accessory parking lot, vehicular access, and reduced development standards for single-unit dwellings in the R-2F, Residential District (Council Variance #CV21-096).

A motion was made by Rob Dorans, seconded by Nicholas Bankston, to Accept entire staff report into evidence as an exhibit. The motion carried by the following vote:

Affirmative: 7 - Nicholas Bankston, Lourdes Barroso De Padilla, Mitchell Brown, Rob Dorans, Shayla Favor, Emmanuel Remy, and Shannon Hardin

A motion was made by Rob Dorans, seconded by Nicholas Bankston, to Adopt the findings of staff as the findings of Council. The motion carried by the following vote:

Affirmative: 7 - Nicholas Bankston, Lourdes Barroso De Padilla, Mitchell Brown, Rob Dorans, Shayla Favor, Emmanuel Remy, and Shannon Hardin

A motion was made by Rob Dorans, seconded by Nicholas Bankston, that this Ordinance be Approved. The motion carried by the following vote:

Affirmative: 7 - Nicholas Bankston, Lourdes Barroso De Padilla, Mitchell Brown, Rob Dorans, Shayla Favor, Emmanuel Remy, and Shannon Hardin

[2203-2023](#)

To grant a Variance from the provisions of Sections 3332.039, R-4 residential district; 3312.13, Driveway; 3312.25, Maneuvering; 3312.29, Parking space; 3312.49(C), Minimum numbers of parking spaces required; 3332.05, Area district lot width requirements; 3332.15, R-4 area district requirements; 3332.18(C), Basis of computing area; 3332.21, Building lines; 3332.25, Maximum side yards required; 3332.26, Minimum side yard permitted, of the Columbus City Codes; for the property located at 172-180 N. CENTRAL AVE. (43222), to permit a mixed use development with reduced development standards in the R-4, Residential District (Council Variance #CV23-048).

A motion was made by Rob Dorans, seconded by Nicholas Bankston, to Accept entire staff report into evidence as an exhibit. The motion carried by the following vote:

Affirmative: 7 - Nicholas Bankston, Lourdes Barroso De Padilla, Mitchell Brown, Rob Dorans, Shayla Favor, Emmanuel Remy, and Shannon Hardin

A motion was made by Rob Dorans, seconded by Shayla Favor, to Adopt the findings of staff as the findings of Council. The motion carried by the following vote:

Affirmative: 7 - Nicholas Bankston, Lourdes Barroso De Padilla, Mitchell Brown, Rob Dorans, Shayla Favor, Emmanuel Remy, and Shannon Hardin

A motion was made by Rob Dorans, seconded by Shayla Favor, that this Ordinance be Approved. The motion carried by the following vote:

Affirmative: 7 - Nicholas Bankston, Lourdes Barroso De Padilla, Mitchell Brown, Rob Dorans, Shayla Favor, Emmanuel Remy, and Shannon Hardin

[2211-2023](#)

To grant a Variance from the provisions of Sections 3333.18, Building lines; 3333.255, Perimeter yard; and 3333.35(G), Private garage, of the Columbus City Codes; for the property located at 4300 ALKIRE RD. (43228), to permit reduced development standards for an apartment complex in the L-AR-1, Limited Apartment Residential District (Council Variance #CV23-036).

A motion was made by Rob Dorans, seconded by Shayla Favor, to Accept entire staff report into evidence as an exhibit. The motion carried by the following vote:

Affirmative: 7 - Nicholas Bankston, Lourdes Barroso De Padilla, Mitchell Brown, Rob Dorans, Shayla Favor, Emmanuel Remy, and Shannon Hardin

A motion was made by Rob Dorans, seconded by Shayla Favor, to Adopt the findings of staff as the findings of Council. The motion carried by the following vote:

Affirmative: 7 - Nicholas Bankston, Lourdes Barroso De Padilla, Mitchell Brown, Rob Dorans, Shayla Favor, Emmanuel Remy, and Shannon Hardin

A motion was made by Rob Dorans, seconded by Shayla Favor, that this Ordinance be Approved. The motion carried by the following vote:

Affirmative: 7 - Nicholas Bankston, Lourdes Barroso De Padilla, Mitchell Brown, Rob Dorans, Shayla Favor, Emmanuel Remy, and Shannon Hardin

[2216-2023](#)

To grant a Variance from the provisions of Sections 3311.28(b), More objectionable uses; 3312.27(2), Parking setback line; 3312.43, Required surface for parking; 3321.01, Dumpster area; 3363.24, Building lines in an M-manufacturing district; and 3363.41(a), Storage; for the property located at 5200 WINCHESTER PIKE (43110), to permit reduced development standards for manufacturing uses in the L-M, Limited Manufacturing District (Council Variance #CV23-010).

A motion was made by Rob Dorans, seconded by Nicholas Bankston, to Accept entire staff report into evidence as an exhibit. The motion carried by the following vote:

Affirmative: 7 - Nicholas Bankston, Lourdes Barroso De Padilla, Mitchell Brown, Rob Dorans, Shayla Favor, Emmanuel Remy, and Shannon Hardin

A motion was made by Rob Dorans, seconded by Nicholas Bankston, to Adopt the findings of staff as the findings of Council. The motion carried by the following vote:

Affirmative: 7 - Nicholas Bankston, Lourdes Barroso De Padilla, Mitchell Brown, Rob Dorans, Shayla Favor, Emmanuel Remy, and Shannon Hardin

A motion was made by Rob Dorans, seconded by Nicholas Bankston, that this Ordinance be Approved. The motion carried by the following vote:

Affirmative: 7 - Nicholas Bankston, Lourdes Barroso De Padilla, Mitchell Brown, Rob Dorans, Shayla Favor, Emmanuel Remy, and Shannon Hardin

[2217-2023](#)

To grant a Variance from the provisions of Sections 3332.035, R-3 residential district; and 3312.49(C), Minimum numbers of parking spaces required, of the Columbus City Codes; for the property located at 803 BARNETT RD. (43227), to permit a non-assembly catering service business with a reduction in the minimum numbers of parking spaces required in the R-3, Residential District (Council Variance #CV23-021).

A motion was made by Rob Dorans, seconded by Shayla Favor, to Accept entire staff report into evidence as an exhibit. The motion carried by the following vote:

Affirmative: 7 - Nicholas Bankston, Lourdes Barroso De Padilla, Mitchell Brown, Rob Dorans, Shayla Favor, Emmanuel Remy, and Shannon Hardin

A motion was made by Rob Dorans, seconded by Shayla Favor, to Adopt the findings of staff as the findings of Council. The motion carried by the following vote:

Affirmative: 7 - Nicholas Bankston, Lourdes Barroso De Padilla, Mitchell Brown, Rob Dorans, Shayla Favor, Emmanuel Remy, and Shannon Hardin

A motion was made by Rob Dorans, seconded by Shayla Favor, that this Ordinance be Approved. The motion carried by the following vote:

Affirmative: 7 - Nicholas Bankston, Lourdes Barroso De Padilla, Mitchell Brown, Rob Dorans, Shayla Favor, Emmanuel Remy, and Shannon Hardin

[2218-2023](#)

To grant a Variance from the provisions of Section 3333.02, AR-12, ARLD and AR-1 apartment residential district use, of the Columbus City Codes; for the property located at 1291 OAK ST. (43205), to permit commercial office uses in the ARLD, Apartment Residential District (Council Variance #CV23-039).

A motion was made by Rob Dorans, seconded by Shayla Favor, to Accept entire staff report into evidence as an exhibit. The motion carried by the following vote:

Affirmative: 7 - Nicholas Bankston, Lourdes Barroso De Padilla, Mitchell Brown, Rob Dorans, Shayla Favor, Emmanuel Remy, and Shannon Hardin

A motion was made by Rob Dorans, seconded by Shayla Favor, to Adopt the findings of staff as the findings of Council. The motion carried by the following vote:

Affirmative: 7 - Nicholas Bankston, Lourdes Barroso De Padilla, Mitchell Brown, Rob Dorans, Shayla Favor, Emmanuel Remy, and Shannon Hardin

A motion was made by Rob Dorans, seconded by Shayla Favor, that this Ordinance be Approved. The motion carried by the following vote:

Affirmative: 7 - Nicholas Bankston, Lourdes Barroso De Padilla, Mitchell Brown, Rob Dorans, Shayla Favor, Emmanuel Remy, and Shannon Hardin

[2221-2023](#)

To grant a Variance from the provisions of Section 3363.01, Manufacturing districts, of the Columbus City Codes; for the property located at 1728 MARYLAND AVE. (43203), to permit a multi-unit residential development in the M, Manufacturing District (Council Variance #CV23-049).

A motion was made by Rob Dorans, seconded by Nicholas Bankston, to Accept entire staff report into evidence as an exhibit. The motion carried by the following vote:

Abstained: 1 - Shayla Favor

Affirmative: 6 - Nicholas Bankston, Lourdes Barroso De Padilla, Mitchell Brown, Rob Dorans, Emmanuel Remy, and Shannon Hardin

A motion was made by Rob Dorans, seconded by Nicholas Bankston, to Adopt the findings of staff as the findings of Council. The motion carried by the following vote:

Abstained: 1 - Shayla Favor

Affirmative: 6 - Nicholas Bankston, Lourdes Barroso De Padilla, Mitchell Brown, Rob Dorans, Emmanuel Remy, and Shannon Hardin

A motion was made by Rob Dorans, seconded by Nicholas Bankston, that this Ordinance be Approved. The motion carried by the following vote:

Abstained: 1 - Shayla Favor

Affirmative: 6 - Nicholas Bankston, Lourdes Barroso De Padilla, Mitchell Brown, Rob Dorans, Emmanuel Remy, and Shannon Hardin

ADJOURNMENT

A motion was made by Emmanuel V. Remy, seconded by Rob Dorans, to adjourn this Regular Meeting. The motion carried by the following vote:

Affirmative: 7 - Nicholas Bankston, Lourdes Barroso De Padilla, Mitchell Brown, Rob Dorans, Shayla Favor, Emmanuel Remy, and Shannon Hardin

ADJOURNED AT 6:47 P.M.

Ordinances and Resolutions

City of Columbus
City Bulletin Report

Office of City Clerk
90 West Broad Street
Columbus OH 43215-9015
columbuscitycouncil.org

Legislation Number: 0145X-2023

Drafting Date: 7/18/2023

Current Status: Passed

Version: 1

Matter Type: Ceremonial Resolution

To recognize and celebrate the 50th Annual Greek Festival in Columbus.

WHEREAS, the parishioners of the Annunciation Greek Orthodox Cathedral host the Greek Festival annually, providing tours of their Cathedral, seeking out vendors, artists, and performers, investing countless time and resources into creating an excellent guest experience; and

WHEREAS, over the past 50 years, the Greek Festival has grown from a single evening event to a four-day celebration through the hard work and dedication of the Annunciation Church; and

WHEREAS, the Greek Festival welcomes thousands of guests annually, allowing them to experience various aspects of the Greek culture, traditions, and lifestyle and providing opportunities to learn about Greece’s history; and

WHEREAS, the Greek Festival has introduced many Columbus residents and guests to Greek music, dance, art, and cuisine through numerous musical performances, an abundance of authentic food selections, and intricate art displays; and

WHEREAS, the Greek Festival helps to celebrate the Columbus Greek-American community for their commitment to hosting the Greek Festival; now, therefore

BE IT RESOLVED BY THE COUNCIL OF THE CITY OF COLUMBUS: That this Council does hereby recognize and celebrate the 50th Annual Greek Festival, which will take place from September 1, 2023 to September 4, 2023.

Legislation Number: 0150X-2023

Drafting Date: 7/26/2023

Current Status: Passed

Version: 1

Matter Type: Ceremonial Resolution

To Designate August 31st, 2023 as International Overdose Awareness Day in the City of Columbus

WHEREAS, International Overdose Awareness Day is recognized on August 31, 2023; and,

WHEREAS, International Overdose Awareness Day is to pause, honor and reflect on the lives of those who have died from an overdose; and,

WHEREAS, the drug overdose epidemic has plagued the state of Ohio and the City of Columbus for the past 10 years; and,

WHEREAS, The mission of the Columbus and Franklin County Addiction Plan, led by the Columbus Public Health and the partners who represent people with lived experience, government, prevention, treatment and recovery support agencies, is to decrease overdose deaths, decrease overdose incidents and decrease infectious disease; and,

WHEREAS, The Columbus and Franklin County Addiction Plan partners will hold prevention, treatment linkage and recovery support events throughout the month of August to recognize this date; and,

WHEREAS, On August 31st, 2023, from 12p - 6pm, the Columbus and Franklin County Addiction Plan will hold a day of remembrance and memorial at St. Stephen’s Community Center with the event, “Time to Remember. Time to Act. Time to Step on Overdose & Addiction;” and,

WHEREAS, this event will provide free access to Fentanyl test strips, Naloxone, substance abuse treatment information and support to connect individuals to treatment, vaccines and other resources; and,
WHEREAS, the City extends our sorrow to the friends and family who have had their lives forever changed by these untimely deaths and extend to them strength and empathy, and commits itself toward ending the drug epidemic plaguing Central Ohio; now, therefore:
BE IT RESOLVED BY THE COUNCIL OF THE CITY OF COLUMBUS: That this Council designates August 31st, 2023 as International Overdose Awareness Day in the City of Columbus and encourages Columbus residents to observe the month with appropriate awareness and educational activities.

Legislation Number: 0151X-2023

Drafting Date: 7/26/2023

Current Status: Passed

Version: 1

Matter Type: Ceremonial Resolution

To Commend the Columbus Women’s Commission on their Advocacy for Black Women’s Pay Equity

WHEREAS, it is estimated that on average Black women make \$0.58 for every \$1.00 earned by White men, with this discrepancy costing Black women upwards of \$900,000 in lost earnings over the course of a 40-year career; and

WHEREAS, Black women are faced with a unique burden: they are impacted by both a pervasive racial income gap and gender-based pay disparities; and

WHEREAS, the COVID-19 impacted many families, including financially, but Black women have shouldered a disproportionate share of the burden. In 2020, the unemployment rate for Black women peaked at 16.6%, and in August 2022, that rate decreased to 5.9%, 2.8 percentage points higher than their White male counterparts; and

WHEREAS, this pay inequality has a multitude of secondary effects, including food insecurity, the perpetuation of the racial and gender wealth gap, financial precarity, and housing insecurity; and

WHEREAS, recent estimates have shown that single Black women own \$200 in wealth for every \$28,900 single White men own, a staggering disparity that is due in part because of pay inequality; and

WHEREAS, the Columbus Women’s Commission is hosting a “Black Women’s Equal Pay Signing Event” to secure commitments from business leaders and organizations across the city to work towards eliminating pay disparities among their workers; and,

WHEREAS, the Columbus Women’s Commission has been a tireless advocate of advancing gender and racial pay equity, launching the Columbus Commitment: Achieving Pay Equity campaign; and,

WHEREAS under the leadership of First Lady Shannon Ginther, the Commission has played a critical role in the progress the City has had as it relates to gender equality within the areas of housing, workforce development, equity in the workplace, and health; Now, therefore, be it: and,

BE IT RESOLVED BY THE COUNCIL OF THE CITY OF COLUMBUS: That this Council commends the Columbus Women’s Commission on their advocacy for Black Women’s Pay Equity and expresses its gratitude for the Commission’s leadership on gender equality issues within the City

Legislation Number: 1552-2023

Drafting Date: 5/17/2023

Current Status: Passed

Version: 2

Matter Type: Ordinance

Background:

This ordinance authorizes awarding \$50,000.00 in summer programming funds for a grant to the following 501(c)(3) nonprofit organization:

- Gladden Community House-\$50,000.00

This grant award will be used to expand quality summer programming for youth residing within the city’s geographical boundaries. Funding will support nonprofit (501c3) organizations looking to establish or grow programs focused on education, arts and crafts, workforce development, financial literacy and more. The term of this grant agreements will begin on June 1, 2023 and will end on December 31, 2023 and the grant shall be paid to awardee in advance.

Emergency Designation: N/A

Fiscal Impact: This ordinance will and authorize the expenditure of \$50,000 from the Recreation and Parks Operating fund where it is budgeted and available. This legislation is contingent on 1521-2023 providing the appropriate appropriation.

To authorize the Director of Recreation and Parks to enter into a non-profit grant agreement with Gladden Community House in support of summer programming to youth; to authorize an appropriation within the Recreation and Parks Operating and Extension Fund; to authorize the expenditure of \$50,000.00 from the Recreation and Parks Operating Fund. (\$50,000.00)

WHEREAS, the Department of Recreation and Parks desires to enter into an advance paid grant agreement with registered non-profit Gladden Community House to help fund summer 2023 programming; and

WHEREAS, funds for the above-described contract are budgeted and available for the above-mentioned purpose in the Recreation and Parks Operating Fund; and

WHEREAS, it is necessary to authorize the expenditure of \$50,000.00 from the Recreation and Parks Operating Fund 2285; **NOW, THEREFORE:**

BE IT ORDAINED BY THE COUNCIL OF THE CITY OF COLUMBUS:

SECTION 1: That the Director of Recreation and Parks be and is hereby authorized to enter into an advance paid grant agreement with non-profit Gladden Community House for summer 2023 programming opportunities, the term of which will begin on June 21, 2023 and end on December 31, 2023.

SECTION 2. That the Auditor is hereby authorized and directed to appropriate \$50,000.00 within the Recreation and Parks Operating and Extension fund, fund 2285, per the accounting codes in the attachment to this ordinance.

See attachment: 1552-2023 AMENDED

SECTION 32. That the expenditure of \$50,000.00, or so much thereof as may be needed, is hereby authorized in Fund 2285 Recreation & Parks Operating Fund in main account 65025 Non-tax reportable grants to others

per the accounting codes in the attachment to this ordinance.

SECTION 43. That the funds necessary to carry out the purpose of this ordinance are hereby deemed appropriated, and the City Auditor shall establish such accounting codes as necessary.

SECTION 54. That the City Auditor is authorized to make any accounting changes to revise the funding source for all contracts or contract modifications associated with this legislation.

SECTION 65. That this agreement is awarded pursuant to the relevant provisions of Chapter 329 of City Code relating to the process for awarding not-for-profit grant agreements.

SECTION 76. That this ordinance shall take effect and be in full force and effect from and after the earliest period allowed by law.

Legislation Number: 1831-2023

Drafting Date: 6/13/2023

Current Status: Passed

Version: 1

Matter Type: Ordinance

This ordinance authorizes the Director of Development to enter into a grant agreement with St. Mary School, Inc. for infrastructure improvements located at St. Mary School.

St. Mary School has experienced unprecedented growth over the last five years, increasing from 244 to nearly 400 students in pre-K through 8th grade for the 2020-2021 year. With increased enrollment comes crowded classrooms, well-worn facilities, and waitlists. However, as our enrollment grows, so does the opportunity to expand our impact.

The new campus will expand the elementary school by 10,000 sq. ft.; improve teaching and learning spaces with the latest technology and systems; provide outdoor learning environments; and provide dedicated space for partners to deliver programs and services.

Improving rights of way and critical infrastructure such as sidewalks in historic neighborhoods is in alignment with the investments the city has made to improve and maintain essential and historic city assets. Columbus City Council deems it to be a public purpose to facilitate these infrastructure improvements, utility repairs and upgrades, and to provide for additional educational and recreation opportunities for residents. Columbus City Council also previously approved this intended expenditure via approval of the 2022 Capital Improvements Budget.

The total campaign goal is \$20 million and, to date, more than \$18.7 million has been raised. All except the \$500,000 commitment from the City is private philanthropic support. The public investment of the City is leveraged by an unprecedented level of community support.

CONTRACT COMPLIANCE: The vendor's contract compliance number is pending.

Fiscal Impact: Funding is available within the Development Taxable Bond Fund.

To authorize the Director of the Department of Development to enter into a grant agreement with St. Mary School, Inc.; to authorize the expenditure of \$500,000.00 from the Development Taxable Bond Fund and to allow for expenditures prior to the Purchase Order. (\$500,000.00)

WHEREAS, St. Mary School has experienced unprecedented growth over the last five years, increasing from 244 to nearly 400 students in pre-K through 8th grade for the 2020-2021 year; and

WHEREAS, with increased enrollment comes crowded classrooms, well-worn facilities, and waitlists; and

WHEREAS, St. Mary School desires to expand the elementary school by 10,000 square feet; and

WHEREAS, the City of Columbus desires to provide a capital grant for improvements benefiting the school and neighborhood; and

WHEREAS, improving rights of way and critical infrastructure such as sidewalks in historic neighborhoods is in alignment with the investments the city has made to improve and maintain essential and historic city assets; and

WHEREAS, it is necessary to authorize a grant agreement in order to help St. Mary School, Inc. achieve success on its capital campaign for the improvements needed at St. Mary School in an amount up to \$500,000.00; **now, therefore,**

BE IT ORDAINED BY THE COUNCIL OF THE CITY OF COLUMBUS:

SECTION 1. That the Director of Development be and is hereby authorized to enter into a Grant Agreement, in an amount up to \$500,000.00 with St. Mary School, Inc. to provide a capital grant supporting expansion of the facility and to reimburse construction costs expenses and professional services costs expenses associated with the planning, design and completion of the permanent improvements as of January 1, 2023 incurred prior to the purchase order which costs are hereby determined to be a valid public purpose.

SECTION 2. That for the purpose as stated in Section 1, the expenditure of \$500,000.00, or so much thereof as may be necessary, is hereby authorized in fund 7739 (Development Taxable Bonds), Project 200027-100000, Dept. 44-01 (Administration), in Object Class 06 (Capital Outlay) per the accounting codes in the attachment to this ordinance.

SECTION 3. That the City Auditor is hereby authorized to transfer the unencumbered balance in a project account to the unallocated balance account within the same fund upon receipt of certification by the Director of the Department administering said project that the project has been completed and the monies are no longer required for said project.

SECTION 4. That the funds necessary to carry out the purpose of this ordinance are hereby deemed appropriated, and the City Auditor shall establish such accounting codes as necessary.

SECTION 5. That the City Auditor is authorized to make any accounting changes to revise the funding source for all contracts or contract modifications associated with this ordinance.

SECTION 6. That this ordinance shall take effect and be in force from and after the earliest period allowed by law.

Legislation Number: 1833-2023

Drafting Date: 6/13/2023

Current Status: Passed

Version: 1

Matter Type: Ordinance

BACKGROUND

This legislation authorizes the Director of the Department of Development to enter into a Grant Agreement with Elevate Northland in an amount of up to \$500,000.00, to advance the planning, design and construction of new community center space that will allow them to continue providing training and business incubation assistance to the Northland community.

Elevate Northland is a not-for-profit community development corporation in Columbus that brings together groups working on business development and building community bonds, with a mission to uplift people of diverse backgrounds and to create opportunities. Elevate Northland will provide the Northland community with a new community center that will feature training space and a business incubator (the “Northland Community Center”).

Grant funding will be used to pay for costs related to planning, designing and constructing the new community center space. Columbus City Council deems it to be a public purpose to invest in Elevate Northland’s community center with the establishment of new co-working space, commercial food preparation space, and overall improved economic development and small business development opportunities. Columbus City Council also previously approved this intended expenditure via approval of the 2022 Capital Improvements Budget.

Approval is also requested for reimbursement of construction costs expenses and professional services cost associated with the planning, design and completion of the permanent improvements incurred prior to execution of the purchase order, starting January 1, 2023.

FISCAL IMPACTS

Funding in the amount of \$500,000.00 is available through the Department of Development’s 2022 Capital Improvement Budget within the Development Taxable Bonds Fund, Fund 7739. The funding will need to be authorized for expenditure from Fund 7739.

CONTRACT COMPLIANCE: Vendor number is 031977 and compliance is pending.

To authorize the Director of the Department of Development to enter into a Grant Agreement with Elevate Northland in an amount of up to \$500,000.00, to advance the planning, design and construction of new community center space to continue providing training and business incubation assistance to the Northland community; and to authorize the expenditure of \$500,000.00 from the Development Taxable Bond Fund and to allow for expenditures prior to the Purchase Order. (\$500,000.00)

WHEREAS, Elevate Northland is a non-profit community development corporation that seeks to uplift the Northland community, including its entrepreneurs and small business owners; and

WHEREAS, Elevate Northland is investing in a new community center that will include training space and a business incubator (the “Northland Community Center”) that will especially target disadvantaged small businesses, businesses owned by immigrants, refugees, women, people of color and business owners disadvantaged by other measures; and

WHEREAS, the City seeks to promote jobs training and creating pathways toward economic stability through entrepreneurship; and

WHEREAS, the City made a commitment of \$500,000.00 to provide Elevate Northland with a capital grant supporting the Northland Community Center; and

WHEREAS, construction cost expenses and professional services cost associated with the planning, design and completion of the permanent improvements incurred prior to execution of the purchase order, starting January 1, 2023, will be reimbursed; and

WHEREAS, it is necessary to authorize the Director of the Department of Development to enter into a grant agreement with Elevate Northland in support of the new community center, in an amount of up to \$500,000.00; **NOW, THEREFORE**,

BE IT ORDAINED BY THE COUNCIL OF THE CITY OF COLUMBUS:

SECTION 1. That the Director of the Department of Development is authorized to enter into a grant agreement with Elevate Northland in an amount up to \$500,000.00 in support of the Northland Business Center. Construction costs expenses and professional services costs associated with the planning, design and completion of the permanent improvements incurred prior to the execution of the purchase order, starting January 1, 2023, are hereby determined to be a valid public purpose and will be reimbursed.

SECTION 2. That the expenditure of \$500,000.00, or so much thereof as may be needed, is hereby authorized in Fund 7739 (Development Taxable Bonds), Dept-Div 4402 (Economic Development), Project 200021-100000 (Elevate Northland), in Object Class 06 Capital Outlay per the account codes in the attachment to this Ordinance.

SECTION 3. That the funds necessary to carry out the purpose of this ordinance are hereby deemed appropriated, authorized for expenditure to carry out the purposes of this ordinance, and the City Auditor shall establish such accounting codes as necessary.

SECTION 4. That the City Auditor is authorized to make any accounting changes to revise the funding source for all contracts or contract modifications associated with this ordinance.

SECTION 5. That the City Auditor is hereby authorized to transfer the unencumbered balance in a project account to the unallocated balance account within the same fund upon receipt of certification by the Director of the Department administering said project that the project has been completed and the monies are no longer required for said project.

SECTION 6. That this ordinance shall take effect and be in force from and after the earliest period allowed by law.

Legislation Number: 1866-2023

Drafting Date: 6/14/2023

Version: 1

Current Status: Passed

Matter Type: Ordinance

BACKGROUND

This legislation authorizes the Director of the Department of Development to enter into an Economic Development Agreement (the “EDA”) with WESTBEND QOZB, LLC (hereinafter the “Developer”) to outline the plans and certain commitments of the Developer and the City as it relates to the WestBend development.

The Developer is proposing to invest approximately \$110 million to construct a mixed-use development on the site of the former Buckeye Auto Parts property on McKinley Avenue currently identified as Franklin County Auditor tax parcel ID numbers 010-146234-00, 010-146253-00, 010-200913-00, 010-146278-00, 010-104705-00, 010-200912-00, and 010-104706-00 (the "Site").

The Developer will perform environmental remediation on the Site and construct approximately 750 apartment units, 20,000 square feet of office space that will include 10,000 square feet of music industry based incubator space (in conjunction with the Columbus Music Commission) or business incubator space with a focus on minority-owned, woman-owned and veteran-owned businesses in the first phase and 10,000 square feet available to the general market in the second phase, 8,000 square feet of retail space and , and a 12 to 17 acre park with a lagoon, dog park, public kayak launch and trails/bikepaths that will be conveyed to the City (the “Project”). The Developer shall reserve at least 10% of the apartment units for lease to households classified at or below 60% Area Median Income (“AMI”), and an additional 10% for lease to households classified at or below 80% Area Median Income (“AMI”), or, alternatively, 30% of the apartment units may be leased to occupants classified at or below 80% Area Median Income (“AMI”) for a period of not less than 15 years.

In support of the Project, the Department of Development will submit for City Council consideration, subsequent legislation that will: 1) establish a non-school Tax Increment Financing (TIF) area and 2) either expand the Marble Cliff Quarry Community Authority or create a new community authority to assist with the financing of eligible public improvements necessary to support the development. In addition, the Department of Development will submit legislation to either expand or create a residential Community Reinvestment Area (the “CRA”) as a “Ready for Revitalization Area” allowing the Site to be eligible to receive a fifteen (15) year one-hundred percent (100%) real property tax abatement and authorize the Director of the Department of Development to enter into an Enterprise Zone Agreement with the Developer for a ten (10) year, seventy-five percent (75%) real property tax abatement related to that part of the Project involving the construction of the office space

FISCAL IMPACTS

There is no fiscal impact for this legislation.

To authorize the Director of the Department of Development to enter into an Economic Development Agreement with WESTBEND QOZB, LLC to outline the mutual plans and certain commitments of the parties as it relates to the WestBend development on the former site of Buckeye Auto Parks property on McKinley Avenue.

WHEREAS, WESTBEND QOZB, LLC (the “Developer”) is proposing to invest approximately \$110 million to construct a mixed-use development on the site of the former Buckeye Auto Parts property on McKinley Avenue currently identified as Franklin County Auditor tax parcel ID numbers 010-146234-00, 010-146253-00, 010-200913-00, 010-146278-00, 010-104705-00, 010-200912-00, and 010-104706-00 (the “Site”); and

WHEREAS, the Developer will perform environmental remediation on the Site to construct approximately 750 apartment units, 20,000 square feet of office space, 8,000 square feet of retail space, and an approximate 12 to 17 acre park with a lagoon, dog park, public kayak launch and trails/bikepaths that will be conveyed to the City (the “Project”); and

WHEREAS, as part of the Developer’s commitment to the City’s policy goals, the Developer will reserve a portion of the residential units for inclusive housing. The Developer shall reserve at least 10% of the apartment units for lease to households classified at or below 60% Area Median Income (“AMI”), and an additional 10% for lease to households classified at or below 80% Area Median Income (“AMI”), or, alternatively, 30% of the apartment units may be leased to occupants classified at or below 80% Area Median Income (“AMI”) for a period of not less than 15 years; and

WHEREAS, the Project will include 10,000 square feet of business incubator space focused on music industry based businesses or minority-owned, woman-owned and veteran-owned businesses, and convey an approximate 12 to 17 acre public park to the City; and

WHEREAS, as part of a public-private-partnership (P3), the City desires to encourage the redevelopment of the Site by funding through tax increment financing and new community authority charges, the design and construction of certain eligible public improvements; and

WHEREAS, the City's commitment to provide financial assistance for the public improvements as well as community reinvestment area and enterprise zone exemptions for parts of the Project, is contingent upon either appropriation and/or authorization pursuant to subsequent passage of legislation submitted for City Council consideration; and

WHEREAS, the City and the Developer desire to memorialize their understanding and commitments with respect to such cooperation by entering into an Economic Development Agreement (the “EDA”); and

WHEREAS, it is necessary to authorize the Director of the Department of Development to enter into an EDA with the Developer in support of the WestBend project; **NOW, THEREFORE,**

BE IT ORDAINED BY THE COUNCIL OF THE CITY OF COLUMBUS:

Section 1. That the Director of the Department of Development, or his or her designee, (the “Director”), on behalf of the City, is authorized to enter into an Economic Development Agreement presently on file with the Department of Development, along with any changes or amendments thereto not inconsistent with this Ordinance and not substantially adverse to the City and which shall be approved by the Director and the City Attorney, provided that the approval of such changes and amendments thereto, and the character of those changes and amendments not being substantially adverse to the City, shall be evidenced conclusively by the execution and delivery of the Economic Development Agreement with WESTBEND QOZB, LLC to outline the plans and certain commitments of the parties regarding the proposed redevelopment of property on McKinley Avenue currently identified as Franklin County Auditor tax parcel ID numbers 010-146234-00, 010-146253-00, 010-200913-00, 010-146278-00, 010-104705-00, 010-200912-00, and 010-104706-00.

Section 2. That this ordinance shall take effect and be in force from and after the earliest period allowed by law.

Legislation Number: 1871-2023

Drafting Date: 6/15/2023

Current Status: Passed

Version: 1

Matter Type: Ordinance

BACKGROUND:

In an effort to modernize code language, correct typographical errors, and to address specific land use regulations in order to more efficiently regulate changing land use patterns and development trends, it is necessary to update various code sections in Title 33, the Columbus Zoning Code.

This ordinance, in addition to correcting typographic errors and updating terms and nomenclature, will also make some minor regulatory changes. The proposed code changes will allow single- and two-unit dwellings in apartment residential zoning districts where apartment complexes are already allowed, as well as adjusting the frontage requirements, and eliminating the need for variances when multi-unit residential developments cross parcel lines with differing taxing districts that cannot be combined. These code changes will also permit automobile maintenance and repair uses in the M-1 and M-2 Manufacturing districts, where heavy truck/bus service garage and repair of fleet vehicles are already allowed. Additionally, the proposed changes will permit wall graphics on the primary frontage of a building even if the commonly used public entrance may be located elsewhere on the building. This ordinance also reorganizes other code provisions to achieve more efficient administration of the Zoning Code without substantively changing said regulations.

A public hearing was held before the Columbus Development Commission on June 8, 2023, and the Columbus Graphics Commission at their June 20, 2023 meeting.

FISCAL IMPACT:

No funding is required for this legislation.

To repeal and amend various sections in Title 33 of the Columbus City Codes, entitled “Zoning Code,” in order to update and modernize terms, correct typographic mistakes, to clarify that automobile maintenance and repair is an allowable use in the M-1 and M-2 Manufacturing zoning districts, and to allow one- and two-units dwellings in apartment residential zoning districts.

WHEREAS, in an effort to modernize code language, correct typographical errors, and to address specific land use regulations in order to more efficiently regulate changing land use patterns and development trends, it is necessary to update various code sections in Title 33, the Columbus Zoning Code; and

WHEREAS, this ordinance, in addition to correcting typographic errors and updating terms and nomenclature, will also make some needed minor regulatory changes; and

WHEREAS, the proposed code changes will allow single- and two-unit dwellings in apartment residential zoning districts where apartment complexes are already allowed, as well as adjusting the frontage requirements, and eliminating the need for variances when multi-unit residential developments cross parcel lines with differing taxing districts that cannot be combined; and

WHEREAS, these code changes will also allow automobile service and repairs in the M-1 and M-2 Manufacturing zoning districts, where heavy truck/bus service garage and repair of fleet vehicles are already permitted; and

WHEREAS, additionally, the proposed changes will permit wall graphics on the primary frontage of a building even if the commonly used public entrance may be located elsewhere on the building; and

WHEREAS, this ordinance also reorganizes other code provisions to achieve more efficient administration of the Zoning Code without substantively changing said regulations; and

WHEREAS, public hearings were held before the Columbus Development Commission on June 8, 2023, and the Graphics Commission on June 20, 2023, and these proposed code changes are fully supported by these commissions for adoption by Columbus City Council; **NOW, THEREFORE:**

BE IT ORDAINED BY THE COUNCIL OF THE CITY OF COLUMBUS:

SECTION 1. Council finds and determines that for the general health, safety and welfare of the City and its residents, certain sections of Title 33 of the Columbus City Code, entitled “Zoning Code,” are amended as identified in Exhibit “A”, attached hereto and incorporated herein, with additions underlined and deletions stricken.

SECTION 2. All sections of Title 33 of the Columbus City Code, entitled “Zoning Code,” not amended as identified in Exhibit “A”, or indicated as repealed in this ordinance, remain unchanged and enforceable.

SECTION 3. That the existing Sections 3303.00, 3303.005, 3303.01, 3303.02, 3303.06, 3303.13, 3303.16, 3305.051, 3305.07, 3309.03, 3309.04, 3309.10, 3311.11, 3311.30, 3312.55, 3321.05, 3332.18, 3332.19, 3332.37, 3332.38, 3333.02, 3333.025, 3333.03, 3333.035, 3333.04, 3333.15, 3333.16, 3333.259, 3333.34, 3333.35, 3345.16, 3345.17, 3347.12, 3347.13, 3363.20, 3365.01, 3365.18, 3367.01, 3367.11, 3367.31, 3372.602, 3375.01, 3377.08, 3377.24, 3380.102, 3384.01, 3384.021, 3384.03, and 3392.13 of the Columbus City Codes are hereby repealed

SECTION 4. That this Ordinance shall take effect and be in force from and after the earliest date allowed by law.

Legislation Number: 1872-2023

Drafting Date: 6/15/2023

Version: 1

Current Status: Passed

Matter Type: Ordinance

BACKGROUND:

Chapter 3312 of the Columbus Zoning Code, Title 33, regulates Off-Street Parking and Loading. These regulations were last reviewed and overhauled in 2010 with the passage of Ordinance No. 1536-2009.

The code changes contained in this ordinance will update and continue to modernize the Columbus Zoning Code regulations regarding off-street parking and loading by adding code language to better contend with existing situations and situations where parcels cannot be combined due to differing taxing districts. These code changes also add language related to prohibited parking, and clarifies the requirements for stacking spaces, pedestrian circulation routes, parking in a driveway, landscaping, and screening. Additionally, these code changes address parking for office uses in the Short North Special Parking Area.

Further, minor adjustments are made to the minimum number of required off-street parking spaces for specified uses while the list of specified uses is added for clarity. Finally, these code changes streamline the requirements for bicycle parking by removing the design standards that are already regulated by the Department of Public Service. Overall, these code changes will make regulating, applying, and enforcing the provisions of Columbus City Code Chapter 3312, “Off-Street Parking and Loading” easier and more efficient, while also ensuring a consistent approach for all users of the zoning code.

A public hearing was held before the Columbus Development Commission on June 8, 2023, and presentations to the Victorian Village Commission and the Italian Village Commission are being made at each of their respective business meetings in late June.

FISCAL IMPACT:

No funding is required for this legislation.

To repeal and replace various sections in Chapter 3312, “Off-Street Parking and Loading” of the Columbus City Codes in order to update and modernize the minimum number of off-street parking and loading spaces required by code, and to update overall off-street parking and loading space regulations.

WHEREAS, the code changes contained in this ordinance will update and continue to modernize the Columbus Zoning Code regulations regarding off-street parking and loading by adding code language to better contend with existing situations and situations where parcels cannot be combined due to being located in differing tax districts; and

WHEREAS, the code changes also add language related to prohibited parking and clarifies the requirements for stacking spaces, pedestrian circulation routes, parking in a driveway, landscaping, and screening requirements; and

WHEREAS, additionally, the code changes also address parking for office uses in the Short North Special Parking Area; and

WHEREAS, further, minor adjustments are made to the minimum number of required off-street parking spaces for specified uses while the list of specified uses is amended for clarity; and

WHEREAS, these code changes also streamline the requirements for bicycle parking by removing the design standards that are already regulated by the Department of Public Service; and

WHEREAS, overall, these code changes will make regulating, applying, and enforcing the provisions of Columbus City Code Chapter 3312, “Off-Street Parking and Loading” easier and more efficient, while also ensuring a consistent approach for all users of the zoning code; and

WHEREAS, a public hearing was held before the Columbus Development Commission on June 8, 2023, and presentations are being made to the Victorian Village and Italian Village commissions in June, and these proposed code changes are fully supported by these commissions for adoption by Columbus City Council;
NOW, THEREFORE:

BE IT ORDAINED BY THE COUNCIL OF THE CITY OF COLUMBUS:

SECTION 1. Council finds and determines that for the general health, safety and welfare of the City and its residents, certain sections of Chapter 3312 “Off-Street Parking and Loading” of the Columbus City Code, are amended as identified in Exhibit “A”, attached hereto and incorporated herein, with additions underlined and deletions stricken. In furtherance thereof, existing sections 3312.01, 3312.03, 3312.051, 3312.053, 3312.07, 3312.09, 3312.11, 3312.13, 3312.21, 3312.23, 3312.25, 3312.27, 3312.29, 3312.30, 3312.31, 3312.33, 3312.35, 3312.37, 3312.41, 3312.43, 3312.49, 3312.53, and 3312.56 of the Columbus City Code are hereby repealed.

SECTION 2. All sections of Chapter 3312 not repealed or amended as identified in Exhibit “A” with deletions stricken and new language underlined, remain unchanged and enforceable.

SECTION 3. That this Ordinance shall take effect and be in force from and after the earliest date allowed by law.

Legislation Number: 1880-2023

Drafting Date: 6/15/2023

Current Status: Passed

Version: 1

Matter Type: Ordinance

This legislation authorizes the Director of Public Utilities to enter into a service agreement with The Ohio State University, Office of Sponsored Programs for the purpose of providing services for the NPDES Stormwater and Clintonville Blueprint Monitoring Project for the Division of Sewerage and Drainage, Stormwater and Regulatory Management Section.

This ordinance is being submitted in accordance with the relevant provisions of Chapter 329 of the City Code pertaining to waiver of competitive bidding.

The City's Stormwater National Pollutant Discharge Elimination System (NPDES) permit requires the City to monitor discharges from its municipal separate storm sewer system (MS4) during wet weather events. Monitoring and data collection services performed under this project will allow the City to meet its permit obligations. Wet weather monitoring will be performed at stormwater outfalls to characterize the change in quality and quantity of discharges from outfalls in the Clintonville Blueprint Project Area after the installation of green infrastructure (GI). Simulated storm events will be used to quantify changes on storm water quality and quantity from selected GI practices. Tasks associated with this project include all outfall sampling,

laboratory analysis, laboratory data evaluation, report generation, and project management. Additional data collection and analysis will be performed to determine to what extent property values increase or decrease as a result of the installation of GI, to evaluate changes in other selected social and economic indicators, and to evaluate the effect of GI on habitat and biodiversity.

The Ohio State University Office of Sponsored Programs is a non-profit organization, and their support will ensure continued compliance with the City's Stormwater NPDES permit, measure the performance of GI installations for the purpose of improving the design and planning of future projects; and measure the economic, social, and environmental impact of a large-scale GI project on the community in which it is installed.

This contract will cover the period from date of execution through and including March 31, 2024. If unforeseen issues or difficulties are encountered that would require additional funding, a modification would be requested and is subject to and conditioned upon the approval of City Council, and appropriation and certification of funds by the City Auditor.

SUPPLIER: Ohio State University, Office of Sponsored Programs (31-6025986), DAX #006163, Expires 3/29/2025.

Ohio State University, Office of Sponsored Programs is a Non-Profit Organization and therefore does not hold MBE/FBE status.

The company is not debarred according to the Excluded Party Listing System of the Federal Government or prohibited from being awarded a contract according to the Auditor of State Unresolved Findings for Recovery Certified Search.

FISCAL IMPACT: \$275,000.00 is budgeted and available for this program.

\$106,708.45 was spent in 2022

\$223,848.81 was spent in 2021

To authorize the Director of Public Utilities to enter into a service agreement in accordance with the relevant provisions of Chapter 329 of the City Code pertaining to waiver of competitive bidding, with The Ohio State University, Office of Sponsored Programs, for the NPDES Stormwater and Clintonville Blueprint Monitoring Project for the Division of Sewerage and Drainage, Stormwater and Regulatory Management Section; and to authorize the expenditure of \$275,000.00 from the Storm Sewer Operating Fund. (\$275,000.00)

WHEREAS, this ordinance will authorize the Director of Public Utilities to enter into a service agreement with The Ohio State University, Office of Sponsored Programs for the purpose of providing services for the National Pollutant Discharge Elimination System (NPDES) Stormwater and Clintonville Blueprint Monitoring Project for the Division of Sewerage and Drainage, Stormwater and Regulatory Management Section; and

WHEREAS, the City's Stormwater National Pollutant Discharge Elimination System (NPDES) permit requires the City to monitor discharges from its municipal separate storm sewer system (MS4) during wet weather events; and

WHEREAS, the results of this project will attempt to characterize the seasonal types and levels of chemical constituents that are discharged from the City's storm sewer system, and

WHEREAS, the Department of Public Utilities wishes to establish a service agreement in accordance with the relevant provisions of Chapter 329 of the Columbus City Code pertaining to a waiver of competitive bidding; and

WHEREAS, this contract will cover the period from date of execution through and including March 31, 2024. If unforeseen issues or difficulties are encountered that would require additional funding, a modification would be requested and is subject to and conditioned upon the approval of City Council, and appropriation and certification of funds by the City Auditor; and

WHEREAS, it has become necessary in the usual daily operation of the Department of Public Utilities, Division of Sewerage and Drainage, Stormwater and Regulatory Management Section, to authorize the Director of Public Utilities to enter into an agreement for services with The Ohio State University, Office of Sponsored Programs for the NPDES Stormwater and Clintonville Blueprint Monitoring Project, for the preservation of the public health, peace, property, and safety; and **NOW THEREFORE**,

BE IT ORDAINED BY THE COUNCIL OF THE CITY OF COLUMBUS:

SECTION 1. That the Director of Public Utilities be and is hereby authorized to enter into contract with The Ohio State University, Office of Sponsored Projects, 1960 Kenny Road, Columbus, OH 43210-1016, in accordance with the relevant provisions of Chapter 329 of the City Code pertaining to waiver of competitive bidding, for NPDES Stormwater and Clintonville Blueprint Monitoring Project for the Department of Public Utilities accordance with the terms and conditions as shown in the agreement on file in the office of the Division of Sewerage and Drainage, Stormwater and Regulatory Management Section.

SECTION 2. That the expenditure of \$275,000.00 or so much thereof as may be needed, is hereby authorized in Fund 6200 Storm Sewer Operating Fund in object class 03 Services per the accounting codes in the attachment to this ordinance.

SECTION 3. That the funds necessary to carry out the purpose of this ordinance are hereby deemed appropriated and the City Auditor shall establish such accounting codes as necessary.

SECTION 4. That this Ordinance shall take effect and be in force from and after the earliest period allowed by law.

Legislation Number: 1931-2023

Drafting Date: 6/22/2023

Current Status: Passed

Version: 1

Matter Type: Ordinance

Mayor Ginther’s vision for Columbus, America’s Opportunity City, is to create access to a high-quality pre-kindergarten education for every 4-year-old. Addressing early childhood learning means bringing awareness and resources to a critical learning stage in childhood development. Children who come to school ready to learn are more likely to succeed academically and in life.

Children who participate in high-quality pre-kindergarten experiences significantly improve their early literacy, language, and math skills. Ample evidence shows that children who enter school unprepared fall farther and farther behind. Students who get a poor start in their earliest years are likely to struggle in high school and subsequently, fail to graduate.

The purpose of Early Start Columbus is to expand high-quality pre-kindergarten services through partnerships with Columbus City Schools and community-based providers. The providers partnering in the Early Start Columbus Program have all demonstrated their ability to provide a high-quality pre-kindergarten education. All partnering providers are rated at least three stars in the State’s Step Up To Quality rating and improvement system. Providers were chosen from a competitive application process.

State law makes allowable the braiding of Ohio Department of Education Early Childhood Expansion funds with those of the Ohio Department of Jobs and Family Service Publicly Funded Childcare program. The 2023-2024 Early Start Columbus Program combines the Mayor’s Office of Education funds with these funding streams to further extend the number of children served while using City funds more efficiently. This approach uses City funds as “last dollar” funding.

FISCAL IMPACT: This ordinance authorizes an expenditure of \$5,931,325.00 from the 2023 Mayor’s Office of Education’s General Operating fund.

To authorize and direct the Executive Director of the Mayor’s Office of Education to enter into contracts with high-quality pre-kindergarten organizations, selected via a competitive application process, to provide educational services; and to authorize the expenditure not to exceed \$5,931,325.00 from the General Fund; (\$5,931,325.00)

WHEREAS, the Executive Director of the Mayor’s Office of Education desires to enter into contracts with various high-quality pre-kindergarten organizations to provide educational services and quality pre-kindergarten services to Columbus 4-year-olds to prepare them for kindergarten; and

WHEREAS, research shows that quality pre-kindergarten instruction provides meaningful value to children’s educational performance and preparation for school; and

WHEREAS, the goal is that all children in City of Columbus will be kindergarten ready; and

WHEREAS, providers were chosen via a competitive application process available to all providers in Franklin County; and

WHEREAS, it has become necessary in the usual daily operation of the Mayor’s Office of Education to authorize the Director to enter into contracts to meet the operational needs of the Early Start Columbus providers, thereby preserving the public health, peace, property, safety and welfare; **NOW, THEREFORE:**

BE IT ORDAINED BY THE COUNCIL OF THE CITY OF COLUMBUS:

SECTION 1. City Council finds that funding pre-kindergarten organizations is a proper public purpose and furthers the City's goal to provide high-quality education to qualified organizations throughout the City. The Executive Director of the Mayor’s Office of Education is authorized to enter into contracts with the following quality pre-kindergarten organizations, under the terms and conditions and in the amounts deemed necessary to advance the Early Start Columbus initiative. Contracts are being awarded to the below providers. These providers were selected through a competitive application process due to their prior experience and success in providing the same services in the 2022-2023 school year and via a competitive application process:

A Better Choice Daycare and Learning Center
 A. Sophie Rogers School for Early Learning, Ohio State University
 Agora's Little Gems Early Learning and Child Care Center
 Cleverbee Academy LLC
 Childhood League, Inc.
 Chosen Kids Learning Center II-
 Chosen Kids Learning Center III -
 Columbus City Schools/Board of Education
 Columbus Early Learning Centers-
 Connected Pathways Early Learning Centers,
 Creative Child Care, Inc. -
 Fresh Start Learning Academy
 Future Scholars Learning Academy II - 6116 McNaughten Center Columbus, OH 43232 -
 Gladden Community House
 Heavenly Kids Center for Learning LLC
 Ibisus Child Care Center LLC
 Joyful Beginnings Children's Learning Academy -
 Kiddie Kare Servicing Imagine Schools
 The Haynes School, INC. D.B.A. Kiddie Academy -
 Little Disciples Learning Center -
 Little Genius Early Learning Center
 Little Lions Learning Center,
 Little Miracles Early Development Center
 Little Tigers Learning Center
 Mary's Little Lamb Interactive Learning Academy
 Maize Manor Preschool -
 NCBC Human Service Corporation D.B.A. Kids Care Academy -
 Our Kidz Enrichment & Child Care Center -
 Perkins' Playhouse & Learning Center Inc
 St. Mary Magdalene -
 St. Stephen's Community House -
 Starting Point Learning Center -
 Tarbiya Learning Center LLC,
 SproutFive, Southside Early Learning Center
 YMCA of Central Ohio- ELC, ELC West, Hilltop

SECTION 2. That the expenditure of \$5,931,325.00 is authorized as follows (**see attachment**):

Dept/Div: 40-06 | **Obj Class:** 03 | **Main Account:** 63050 | **Fund:** 1000 | **Sub-fund:** 100010 | **Program:** ED001
| Amount: \$5,931,325.00

SECTION 3. That the City Auditor is authorized to make any accounting changes to revise the funding source for all contracts or contract modifications associated with this ordinance.

SECTION 4. That the funds necessary to carry out the purpose of this ordinance are deemed appropriated, and the City Auditor shall establish such accounting codes as necessary.

SECTION 5. That this ordinance shall take effect and be in force from and after the earliest period permitted by law.

Legislation Number: 1961-2023

Drafting Date: 6/23/2023

Version: 1

Current Status: Passed

Matter Type: Ordinance

BACKGROUND:

This ordinance approves the acceptance of certain territory (AN23-003) by the city of Columbus. The Ohio Revised Code stipulates that to be effective, City acceptance must take place a minimum of 60 days from the receipt by the City Clerk of the approval notice from the county. If City Council does not accept the ordinance within 120 days of its first consideration, the annexation will be considered rejected. This petition was filed with Franklin County on April 20, 2023. City Council approved a service ordinance addressing the site on May 1, 2023. Franklin County approved the annexation on May 16, 2023 and the City Clerk received notice on May 30, 2023.

FISCAL IMPACT:

Provision of municipal services does represent cost to the City; however, the annexation of land also has the potential to create revenue to the City.

To accept the application (AN23-003) of Airport Commerce Park LLC for the annexation of certain territory containing 2.3± acres in Mifflin Township.

WHEREAS, a petition for the annexation of certain territory in Mifflin Township was filed on behalf of Airport Commerce Park LLC on April 20, 2023; and

WHEREAS, the petition was considered and approved by the Franklin County Board of Commissioners at a hearing on May 16, 2023; and

WHEREAS, on May 30, 2023, the City Clerk received from Franklin County a certified copy of the resolution addressing the petition; and

WHEREAS, sixty days have now elapsed since receipt of the resolution in accordance with the provisions of the Ohio Revised Code; and

WHEREAS, it is in the best interest of the city of Columbus to accept the annexation of the territory addressed by the petition; now, therefore,

BE IT ORDAINED BY THE COUNCIL OF THE CITY OF COLUMBUS

SECTION 1. That the annexation proposed by Airport Commerce Park LLC in a petition filed with the Franklin County Board of Commissioners on April 20, 2023 and subsequently approved by the Board on May 16, 2023 is hereby accepted and said territory is hereby annexed to the city of Columbus. Said territory is described as follows:

Situated in the State of Ohio, County of Franklin, Township of Mifflin, Quarter Township 4, Township 1, Range 17, United States Military Lands, being part of a 2.72 acre tract of land described in deed to Airport Commerce Park, LLC of record in Instrument Number 202209220135282, all references to records being on file in the Office of the Recorder, Franklin County, Ohio, and being more fully described herein;

COMMENCING at Franklin County Geodetic Survey Monument Number 5739 at the centerline intersection of Johnstown Road and Bridgeway Avenue of record in Plat Book 114, Pages 18-20;

Thence South 61 °57'59" West, a distance of 230.88 feet with the centerline of said Johnstown Road, to the northeast corner of said 2.72 acre tract, and being at the northwest corner of a 0.221 acre tract of land

described in deed to Columbus Municipal Airport Authority of record in Instrument Number 200209250239922;

Thence South 28°02'03" West, a distance of 30.00 feet with the northeast line of said 2.72 acre tract and with the southwest line of said 0.221 acre tract, to the southeast right-of-way line of said Johnstown Road and being the TRUE POINT OF BEGINNING;

Thence SOUTHEASTERLY, a distance of 469 feet, more or less, with the northeast line of said 2.72 acre tract, with the southwest line of said 0.221 acre tract, and with the southwest line of an original 1.04 acre tract of land (Parcel Number Two) described in deed to Gregory C. Pedersen of record in Instrument Number 199907300194067, to the southeast corner of said 2.72 acre tract, being at the southwest corner of said 1.04 acre tract, being on the north line of a 16 foot private drive of record in Deed Book 93, Page 100 and in Deed Book 1188, Page 253, and being on the existing City of Columbus and Mifflin Township line of record in Ordinance Number 9-68 and in Miscellaneous Record Volume 144, Page 491;

Thence WESTERLY, a distance of 391 feet, more or less, with the south line of said 2.72 acre tract, with the north line of said 16 foot private drive, and with said existing City of Columbus and Mifflin Township line, to the southwest corner of said 2.72 acre tract, being on an east line of said 16 foot private drive, and being an angle point of said existing City of Columbus and Mifflin Township line;

Thence NORTHERLY, a distance of 315 feet, more or less, with the west line of said 2.72 acre tract, with an east line of said 16 foot private drive, and with said existing City of Columbus and Mifflin Township line, to the southeast right-of-way line of said Johnstown Road and being an angle point of said existing City of Columbus and Mifflin Township line;

Thence NORTHEASTERLY, a distance of 167 feet, more or less, crossing said 2.72 acre tract and with the southeast right-of-way line of said Johnstown Road, to the TRUE POINT OF BEGINNING, containing 2.3± acres, more or less.

The above description is based on deeds of record and available existing surveys; the aforementioned description is not intended to be used for the transfer of real property. The acreages and distances shown are intended for annexation purposes only.

Area to be annexed shall be an Expedited II annexation, with 706 feet contiguity with the existing corporation line of the City of Columbus, having a total perimeter of 1,342 feet that contains 52.6% contiguity with existing corporation lines of the City of Columbus.

SECTION 2. That the City Clerk is hereby authorized and directed to make three copies of this ordinance to each of which shall be attached a copy of the map accompanying the petition for annexation, a copy of the transcript of proceedings of the Board of County Commissioners relating thereto, and a certificate as to the correctness thereof, the City Clerk shall then forthwith deliver one copy to the County Auditor, one copy to the Board of Elections thereof and do such other things as may be required by law.

SECTION 3. That this ordinance shall take effect and be in force from and after the earliest period allowed by law.

Legislation Number: 1963-2023

Drafting Date: 6/23/2023

Version: 1

Current Status: Passed

Matter Type: Ordinance

BACKGROUND:

This ordinance approves the acceptance of certain territory (AN23-004) by the city of Columbus. The Ohio Revised Code stipulates that to be effective, City acceptance must take place a minimum of 60 days from the receipt by the City Clerk of the approval notice from the county. If City Council does not accept the ordinance within 120 days of its first consideration, the annexation will be considered rejected. This petition was filed with Franklin County on March 22, 2023. City Council approved a service ordinance addressing the site on April 3, 2023. Franklin County approved the annexation on April 25, 2023 and the City Clerk received notice on May 4, 2023.

FISCAL IMPACT:

Provision of municipal services does represent cost to the City; however, the annexation of land also has the potential to create revenue to the City.

To accept the application (AN23-004) of Michael and Lindy McGaughey for the annexation of certain territory containing 0.1± acres in Sharon Township.

WHEREAS, a petition for the annexation of certain territory in Sharon Township was filed on behalf of Michael and Lindy McGaughey on March 22, 2023; and

WHEREAS, the petition was considered and approved by the Franklin County Board of Commissioners at a hearing on April 25, 2023; and

WHEREAS, on May 4, 2023, the City Clerk received from Franklin County a certified copy of the resolution addressing the petition; and

WHEREAS, sixty days have now elapsed since receipt of the resolution in accordance with the provisions of the Ohio Revised Code; and

WHEREAS, it is in the best interest of the city of Columbus to accept the annexation of the territory addressed by the petition; **NOW, THEREFORE**

BE IT ORDAINED BY THE COUNCIL OF THE CITY OF COLUMBUS

SECTION 1. That the annexation proposed by Michael and Lindy McGaughey in a petition filed with the Franklin County Board of Commissioners on March 22, 2023 and subsequently approved by the Board on April 25, 2023 is hereby accepted and said territory is hereby annexed to the city of Columbus. Said territory is described as follows:

Situated in the State of Ohio, County of Franklin, Township of Sharon, and being all of lot 1324 of Mount Air No. 2, as shown and delineated in Plat Book 19, Page 21, and being conveyed to Michael and Linda McGaughey, by deed of record in Instrument Number 201111280154150, being bounded and more particularly described as follows:

Beginning, at the southeasterly corner of the City of Columbus corporation line, established by Ordinance Number 1783-01 and recorded in Instrument Number 200202120038710, the southeasterly corner

of lot 1323 of said Mount Air No. 2, the southeasterly corner of a 1.688 acre tract conveyed to Michael and Linda McGaughey, by deed of record in Instrument Number 200608300172825, the southwesterly corner of said lot 1324, and on the northerly line of Edgecliff Drive (35 feet wide, P.B. 19, Pg. 21);

Thence Northerly, a distance of approximately 87 feet, along the easterly City of Columbus corporation line, and along the line common to said lots 1323 and 1324, and said 1.688 acre tract, to a point, at the northerly common corner of said lots 1323 and 1324;

Thence Easterly, a distance of approximately 46 feet, along the southerly City of Columbus corporation line, and the line common to said lot 1324 and said 1.688 acre tract, to a point, at the northeasterly corner of said lot 1324, the southwesterly corner of said 1.688 acre tract, the northwesterly corner of lot 1325 of said Mount Air No. 2, the northwesterly corner of a 0.616 acre tract conveyed to Hickory Bluff Farms, by deed of record in Instrument Number 200608300172828, and the southwesterly corner of a 1.570 acre tract

conveyed to Hickory Bluff Farms, by deed of record in Instrument Number 200512060257097; Thence Southerly, a distance of approximately 100 feet, -along the westerly City of Columbus corporation line, and along the line common to said lots 1324 and 1325, and said 0.616 acre tract, to a point, at the southerly common corner of said lot 1324 and 1325, and on the northerly line of said Edgecliff Drive; Thence Westerly, a distance of approximately 35 feet, along the line common to said lot 1324 and said Edgecliff Drive, to the Point of Beginning, containing approximately 0.1 acres, more or less. The total perimeter of Annexation is 268 feet, of which 233 feet is contiguous with the City of Westerville, giving 86.9 percent perimeter contiguity.

The above description was prepared from record information and is for annexation purposes only. A field survey is not required for annexation purposes.

SECTION 2. That the City Clerk is hereby authorized and directed to make three copies of this ordinance to each of which shall be attached a copy of the map accompanying the petition for annexation, a copy of the transcript of proceedings of the Board of County Commissioners relating thereto, and a certificate as to the correctness thereof, the City Clerk shall then forthwith deliver one copy to the County Auditor, one copy to the Board of Elections thereof and do such other things as may be required by law.

SECTION 3. That this ordinance shall take effect and be in force from and after the earliest period allowed by law.

Legislation Number: 1964-2023

Drafting Date: 6/23/2023

Current Status: Passed

Version: 1

Matter Type: Ordinance

BACKGROUND:

This ordinance approves the acceptance of certain territory (AN23-005) by the city of Columbus. The Ohio Revised Code stipulates that to be effective, City acceptance must take place a minimum of 60 days from the receipt by the City Clerk of the approval notice from the county. If City Council does not accept the ordinance within 120 days of its first consideration, the annexation will be considered rejected. This petition was filed with Franklin County on March 22, 2023. City Council approved a service ordinance addressing the site on April 3, 2023. Franklin County approved the annexation on April 25, 2023 and the City Clerk received notice on May 4, 2023.

FISCAL IMPACT:

Provision of municipal services does represent cost to the City; however, the annexation of land also has the potential to create revenue to the City.

To accept the application (AN23-005) of Michael and Lindy McGaughey for the annexation of certain territory containing 0.1± acres in Sharon Township.

WHEREAS, a petition for the annexation of certain territory in Sharon Township was filed on behalf of Michael and Lindy McGaughey on March 22, 2023; and

WHEREAS, the petition was considered and approved by the Franklin County Board of Commissioners at

a hearing on April 25, 2023; and

WHEREAS, on May 4, 2023, the City Clerk received from Franklin County a certified copy of the resolution addressing the petition; and

WHEREAS, sixty days have now elapsed since receipt of the resolution in accordance with the provisions of the Ohio Revised Code; and

WHEREAS, it is in the best interest of the city of Columbus to accept the annexation of the territory addressed by the petition; **now, therefore**,

BE IT ORDAINED BY THE COUNCIL OF THE CITY OF COLUMBUS

SECTION 1. That the annexation proposed by Michael and Lindy McGaughey in a petition filed with the Franklin County Board of Commissioners on March 22, 2023 and subsequently approved by the Board on April 25, 2023 is hereby accepted and said territory is hereby annexed to the city of Columbus. Said territory is described as follows:

Situated in the State of Ohio, County of Franklin, Township of Sharon, and being all of lot 1321 of Mount Air No. 2, as shown and delineated in Plat Book 19, Page 21, and being conveyed to Michael J. and Linda S. McGaughey, by deed of record in Instrument Number 201512290181753, being bounded and more particularly described as follows:

Beginning, at the southeasterly comer of the City of Columbus corporation line, established by Ordinance Number 1783-01 and recorded in Instrument Number 200202120038710, the southeasterly comer of lot 1320 of said Mount Air No. 2, the southeasterly comer of a 1.688 acre tract conveyed to Michael and Linda McGaughey, by deed of record in Instrument Number 200608300172825, the southwesterly comer of said lot 1321, and on the northerly line of Edgecliff Drive (35 feet wide, P.B. 19, Pg. 21);

Thence Northwesterly, a distance of approximately 77 feet, along the easterly City of Columbus corporation line, and along the line common to said lots 1320 and 1321, and said 1.688 acre tract, to a point, at the northerly common comer of said lots 1320 and 1321;

Thence Northeasterly, a distance of approximately 35 feet, along the southerly City of Columbus corporation line, and the line common to said lot 1321 and said 1.688 acre tract, to a point, at the northeasterly comer of said lot 1321, and the northwesterly comer of lot 1322 of said Mount Air No. 2;

Thence Southeasterly, a distance of approximately 77 feet, along the westerly City of Columbus corporation line, and along the line common to said lots 1321 and 1322, and said 1.688 acre tract, to a point, at the southerly common comer of said lot 1321 and 1322, and on the northerly line of said Edgecliff Drive;

Thence Southwesterly, a distance of approximately 35 feet, along the line common to said lot 1321 and said Edgecliff Drive, to the Point of Beginning, containing approximately 0.1 acres, more or less.

The total perimeter of Annexation is 224 feet, of which 189 feet is contiguous with the City of Westerville, giving 84.4 percent perimeter contiguity.

The above description was prepared from record information and is for annexation purposes only. A field survey is not required for annexation purposes.

SECTION 2. That the City Clerk is hereby authorized and directed to make three copies of this ordinance to each of which shall be attached a copy of the map accompanying the petition for annexation, a copy of the transcript of proceedings of the Board of County Commissioners relating thereto, and a certificate as to the correctness thereof, the City Clerk shall then forthwith deliver one copy to the County Auditor, one copy to the Board of Elections thereof and do such other things as may be required by law.

SECTION 3. That this ordinance shall take effect and be in force from and after the earliest period allowed by law.

Legislation Number: 1966-2023

Drafting Date: 6/23/2023

Version: 1

Current Status: Passed

Matter Type: Ordinance

BACKGROUND:

This ordinance approves the acceptance of certain territory (AN23-008) by the city of Columbus. The Ohio Revised Code stipulates that to be effective, City acceptance must take place a minimum of 60 days from the receipt by the City Clerk of the approval notice from the county. If City Council does not accept the ordinance within 120 days of its first consideration, the annexation will be considered rejected. This petition was filed with Franklin County on April 5, 2023. City Council approved a service ordinance addressing the site on April 17, 2023. Franklin County approved the annexation on May 23, 2023 and the City Clerk received notice on May 30, 2023.

FISCAL IMPACT:

Provision of municipal services does represent cost to the City; however, the annexation of land also has the potential to create revenue to the City.

To accept the application (AN23-008) of John Martin & David Martin for the annexation of certain territory containing 0.8± acres in Jackson Township.

WHEREAS, a petition for the annexation of certain territory in Jackson Township was filed on behalf of John Martin & David Martin on April 5, 2023; and

WHEREAS, the petition was considered and approved by the Franklin County Board of Commissioners at a hearing on May 23, 2023; and

WHEREAS, on May 30, 2023, the City Clerk received from Franklin County a certified copy of the resolution addressing the petition; and

WHEREAS, sixty days have now elapsed since receipt of the resolution in accordance with the provisions of the Ohio Revised Code; and

WHEREAS, it is in the best interest of the city of Columbus to accept the annexation of the territory addressed by the petition; **now, therefore**,

BE IT ORDAINED BY THE COUNCIL OF THE CITY OF COLUMBUS

SECTION 1. That the annexation proposed by John Martin & David Martin in a petition filed with the Franklin County Board of Commissioners on April 5, 2023 and subsequently approved by the Board on May 23, 2023 is hereby accepted and said territory is hereby annexed to the city of Columbus. Said territory is described as follows:

Situate in the State of Ohio, County of Franklin, Township of Jackson, in Virginia Military Survey #1389, being all of the 0.768 Acre tract conveyed to Jack E. and Ruth M. Martin in Deed Book 2804, Page 643 and part of the 0.559 Acre tract conveyed to City of Columbus in Instrument Number 1998031800623 73, all records being of the Recorder's Office, Franklin County, Ohio and being more particularly bounded and described as follows:

BEGINNING in the centerline of Demorest Road, at the northwest corner of said 0.768 Acre tract, at the southwest corner of a 0.668 Acre tract conveyed to Jacob Suslowitz in Instrument Number 201711170163114 and in the east line of said 0.559 Acre tract;

Thence, easterly, along the north line of said 0.768 Acre tract and along the south line of said 0.668 Acre tract, approximately 264 feet to the northeast corner of said 0.768 Acre tract, the southeast corner of said 0.668 Acre tract and in the west line of a 2.667 Acre tract conveyed to Jack Lee Harding and Nancy Rose Harding in Instrument Number 200710160181043;

Thence, southerly, along the east line of said 0.768 Acre tract and along part of the west line of said 2.667 Acre tract, approximately 127 feet to the southeast corner of said 0.768 Acre tract and the northeast corner of a 1.136 Acre tract conveyed to Tina Green in Instrument Number 201705220068165;

Thence, westerly, along the south line of said 0.768 Acre tract, along the north line of said 1.136 Acre tract, across part of said 0.559 Acre tract and across Demorest Road, approximately 289 feet to the original west right of way line of Demorest Road and the existing City of Columbus Corporation Line as established by Ordinance Number 2237- 97, Case Number 17-97, of record in Instrument Number 199801280019421;

Thence, northerly, along the original west right of way line of Demorest Road, across part of said 0.559 Acre tract, along part of said existing City of Columbus Corporation Line and along the existing City of Columbus Corporation Line as established by Ordinance Number 1581-76, Case Number 5-76, of record in Miscellaneous Record 167, Page 57, approximately 127 feet to the westerly extension of the north line of said 0.768 Acre tract and the south line of said 0.668 Acre tract;

Thence, easterly, across part of said 0.559 Acre tract, along the westerly extension of the north line of said 0.768 Acre tract and the south line of said 0.668 Acre tract and across part of Demorest Road, approximately, 25 feet to the POINT OF BEGINNING, CONTAINING 0.8 ACRES, MORE OR LESS. This description was prepared from record information only and is not based on a field survey. This description is for annexation purposes only.

SECTION 2. That the City Clerk is hereby authorized and directed to make three copies of this ordinance to each of which shall be attached a copy of the map accompanying the petition for annexation, a copy of the transcript of proceedings of the Board of County Commissioners relating thereto, and a certificate as to the correctness thereof, the City Clerk shall then forthwith deliver one copy to the County Auditor, one copy to the Board of Elections thereof and do such other things as may be required by law.

SECTION 3. That this ordinance shall take effect and be in force from and after the earliest period allowed by law.

Legislation Number: 1975-2023

Drafting Date: 6/26/2023

Current Status: Passed

Version: 1

Matter Type: Ordinance

BACKGROUND: This legislation authorizes the Finance and Management Director to associate all General Budget Reservations resulting from this ordinance with the following Universal Term Contract Purchase Agreements listed below for the Division of Power.

The lamps from these contracts will be used to replenish stock, maintain existing street lights and for new construction for future development within the City.

The following Purchase Agreement association requires approval by City Council in order for the Division to expend more than \$100,000.00, per CCC Sec. 329.19(g):

UNIVERSAL TERM CONTRACT PURCHASE AGREEMENTS:

Purchase of Lamps PA005347 & PA005348

The companies are not debarred according to the Excluded Party Listing System of the Federal Government or prohibited from being awarded a contract according to the Auditor of State Unresolved Findings for Recovery Certified Search.

SUPPLIERS:

Grainger, vendor #007170, CC expires 2/2/24, majority vendor
Consolidated Electrical Distributors, Inc., vendor #010270, CC expires 5/4/25, majority vendor

FISCAL IMPACT: \$60,000.00 is budgeted and needed for this purchase.

\$258,292.06 was spent in 2022
\$101,368.84 was spent in 2021

To authorize the Finance and Management Director to associate all General Budget Reservations resulting from this ordinance with the appropriate Universal Term Contract Purchase Agreements for the purchase of lamps for the Division of Power; and to authorize the expenditure of \$60,000.00 from the Electricity Operating Fund. (\$60,000.00)

WHEREAS, the Purchasing Office has established Universal Term Contract Purchase Agreements for the purchase of lamps; and

WHEREAS, the expenditure of \$60,000.00, or so much thereof as is needed for the purchase of lamps from and within the Electricity Operating Fund; and

WHEREAS, the lamps will be used to replenish stock, maintain existing street lights and for new construction for future development within the City; and

WHEREAS, it has become necessary in the usual daily operation of the Department of Public Utilities to authorize the Finance and Management Director to associate all General Budget Reservations resulting from this ordinance with the appropriate Universal Term Contract Purchase Agreements for the purchase of lamps;

NOW, THEREFORE,

BE IT ORDAINED BY THE COUNCIL OF THE CITY OF COLUMBUS:

SECTION 1. That the Finance and Management Director be and hereby is authorized to associate all General Budget Reservations resulting from this ordinance with the appropriate Universal Term Contract Purchase Agreements for the purchase of lamps.

SECTION 2. That the expenditure of \$60,000.00, or so much thereof as may be needed, be and is hereby authorized in Fund 6300 (Electricity Operating) in object class 02 Materials and Supplies per the accounting codes in the attachment to this ordinance.

SECTION 3. That the funds necessary to carry out the purpose of this ordinance are hereby deemed appropriated, and the City Auditor shall establish such accounting codes as necessary.

SECTION 4. That this Ordinance shall take effect and be in force from and after the earliest period allowed by law.

Legislation Number: 1984-2023

Drafting Date: 6/26/2023

Current Status: Passed

Version: 1

Matter Type: Ordinance

1. BACKGROUND:

In a continued effort to improve operational efficiencies, provide better services to the public, and to streamline government organization and communication, it was determined that the Department of Public Services needs to make updates to the existing Title 9 of the Columbus City Codes 1959, as amended.

The purpose of this legislation is to enact, amend and repeal various sections of Title 9 of the Columbus City Codes, 1959, as amended that addresses various inadequacies within the existing code while also providing greater flexibility for its enforcement in the future.

2. FISCAL IMPACT:

There is no direct fiscal impact associated with this code change.

To enact, amend, and repeal various sections and chapters of Title 9 of the Columbus City Codes to improve operational efficiencies, provide better services to the public and provide for better enforcement of Title 9 violations through civil penalties and fines.

WHEREAS, in a continued effort to improve operational efficiencies, provide better services to the public, and to streamline government organization and communication, it was determined that the Department of Public Services needs to make updates to the existing Title 9 Code of Columbus City Code 1959, as amended; and

WHEREAS, it is necessary to enact the following sections of the Columbus City Codes: 900.021, 900.022, 900.023, 900.031, 900.041, 900.042, 900.051, 900.052, 900.053, 900.061, 900.081, 900.082, 903.07, 906.07, 906.08, 908.00, 908.01, 908.02, 908.03, 908.04, 908.05; and

WHEREAS, it is necessary to amend the following sections of the Columbus City Codes: 900.01, 900.03, 900.04, 900.06, 900.09, 901.01, 901.02, 902.00, 902.01, 902.02, 902.03, 902.04, 902.99, 903.01, 903.02, 903.03, 903.04, 903.05, 903.06, 903.99, 904.0, 904.01, 904.02, 904.04, 904.05, 904.06, 904.99, 905.01, 905.03, 905.04, 905.05, 905.06, 905.07, 905.071, 905.075, 905.08, 905.09, 905.10, 905.11, 905.99, 906.00, 906.01, 906.02, 906.03, 906.04, 906.99, 907.01, 907.05, 907.99, 909.03, 909.04, 909.05, 909.06; and,

WHEREAS, in addition to the existing sections that have been amended it is necessary to repeal the following sections of the Columbus City Codes: 2101.55, 2151.23, 2151.24, 2155.06; **NOW, THEREFORE**,

BE IT ORDAINED BY THE COUNCIL OF THE CITY OF COLUMBUS:

SECTION 1. That specific chapters and sections of Title 9 of the Columbus City Codes are hereby amended by the enactment of new Sections 900.021, 900.022, 900.023, 900.031, 900.041, 900.042, 900.051, 900.052, 900.053, 900.061, 900.081, 900.082, 903.07, 906.07, 906.08, 908.00, 908.01, 908.02, 908.03, 908.04, and 908.05 to read as follows per the attached word documents:

Chapter 900 6.23.23, Chapter 903 6.22.23, Chapter 906 6.22.23, and Chapter 908 6.26.23.

SECTION 2. That Sections 900.01, 900.03, 900.04, 900.06, 900.09, 901.01, 901.02, 902.00, 902.01, 902.02, 902.03, 902.04, 902.99, 903.01, 903.02, 903.03, 903.04, 903.05, 903.06, 903.99, 904.0, 904.01, 904.02, 904.04, 904.05, 904.06, 904.99, 905.01, 905.03, 905.04, 905.05, 905.06, 905.07, 905.071, 905.075, 905.08, 905.09, 905.10, 905.11, 905.99, 906.00, 906.01, 906.02, 906.03, 906.04, 906.99, 907.01, 907.05, 907.99, 909.03, 909.04, 909.05, and 909.06 are hereby amended to read as follows per the attached word documents:

Chapter 900 6.23.23, Chapter 901 6.23.23, Chapter 902 6.22.23, Chapter 903 6.22.23, Chapter 904 6.22.23, Chapter 905 6.27.23, Chapter 906 6.22.23, Chapter 907 6.22.23, and Chapter 909 6.26.23.

SECTION 3. That existing Sections 900.01, 900.03, 900.04, 900.06, 900.09, 901.01, 901.02, 902.00, 902.01, 902.02, 902.03, 902.04, 902.99, 903.01, 903.02, 903.03, 903.04, 903.05, 903.06, 903.99, 904.0, 904.01, 904.02, 904.04, 904.05, 904.06, 904.99, 905.01, 905.02, 905.03, 905.04, 905.05, 905.06, 905.07, 905.071, 905.075, 905.08, 905.09, 905.10, 905.11, 905.12, 905.13, 905.14, 905.15, 905.16, 905.99, 906.00, 906.01, 906.02, 906.03, 906.04, 906.99, 907.01, 907.05, 907.99, 909.03, 909.04, 909.05, 909.06, 922.01, 922.02, 922.03, and 922.04 are hereby repealed and/or reserved as follows per the attached word documents:

Chapter 900 6.23.23, Chapter 901 6.23.23, Chapter 902 6.22.23, Chapter 903 6.22.23, Chapter 904 6.22.23, Chapter 905 6.27.23, Chapter 906 6.22.23, Chapter 907 6.22.23, Chapter 909 6.26.23 and Chapter 922 06.23.23

SECTION 4. That this ordinance will take effect and be in force from and after the earliest period allowed by law.

Legislation Number: 1990-2023

Drafting Date: 6/27/2023

Version: 1

Current Status: Passed

Matter Type: Ordinance

1. BACKGROUND: This legislation authorizes the Director of Finance and Management to enter into a construction contract, on behalf of the Office of Construction Management, with 2K General Company, for the Health Department Expansion Renovation Project, in the amount of \$21,493,900.00.

This project consists of a full interior renovation of over 60,000 sq. ft. of the historic Health Department building located at 240 Parsons Avenue. The majority of the work will take place on the 3rd and 4th floors, with associated work throughout the building. Associated work includes: HVAC, mechanical, electrical, plumbing, demolition, structural/architectural remediation, fire suppression and alarms. Improvements/upgrades will also be made to the technology/security system, elevators, pumps, water heater, chiller, furniture, fixtures, and equipment. This is a 16-month construction project in an occupied building.

2. CONSTRUCTION CONTRACT AWARD: The project was let by the Office of Construction Management via Bid Express. Three bids were opened on June 5, 2023 from Majority-owned firms:

- | | | |
|----|----------------------------|-----------------|
| 1. | 2K General Company | \$21,493,900.00 |
| 2. | Elford, Inc. | \$21,806,437.00 |
| 3. | Setterlin Building Company | \$23,156,676.00 |

*Pricing includes alternates

2K General Company's bid was deemed the lowest, best, most responsive and responsible bid in the amount of \$21,493,900.00. Their Contract Compliance Number is 5739 (expires 6/14/24, Majority-designated).

3. SUBCONTRACTOR PARTICIPATION: The Office of Diversity & Inclusion (ODI) assigned a 20% goal for this project. 2K General Company proposed the following subcontractors to partially meet this goal:

<u>Company Name</u>	<u>City/State</u>	<u>ODI Status</u>
Ardit Co.	Columbus, OH	WBE
Barnett Mechanical	Columbus, OH	MBE
Goldtech of Ohio	Hilliard, OH	MBE
MVC Ltd. dba Multivista	Westerville, OH	MBE
Majestic Rehab & Remodeling	Columbus, OH	MBE & WBE

ODI approved 2K General's Request for MBE/WBE Goal Waiver and Documentation of Good Faith Effort.

Minority vendor certification was in good standing at the time the bid was awarded.

4. BID WAIVER INFO.: The Department requests a waiver of Chapter 378 of Columbus City Codes relating to approval by the Community Benefits Agreement Advisory Committee. This project was initially bid prior to this Chapter being enacted and the need for subsequent re-bids were thought to comply with previous code requirements. This waiver is also requested so that necessary renovations at Columbus Public Health can commence as quickly as possible.

5. FISCAL IMPACT: Transfers within the Safety G.O. Bond Fund - Fund No. 7701, Health G.O. Bond Fund - Fund No. 7706, and Construction Management Capital Improvement Fund - Fund No. 7733 will be necessary as well as an amendment to the 2023 Capital Improvements Budget. Amendments to the 2023 Capital Improvements Budget are contingent upon passage of the 2023 Capital Improvements Budget.

To authorize the Director of Finance and Management, on behalf of the Office of Construction Management, to enter into a construction contract with 2K General Company for the Health Department Expansion Renovation Project; to waive the provisions of Columbus City Codes, Chapter 378, in regards to approval by the Community Benefits Agreement Advisory Committee; to authorize transfers and expenditures up to \$21,493,900.00 within the Safety General Obligation Bond Fund, the Health General Obligations Bond Fund, and the Construction Management Capital Improvement Fund; and to authorize an amendment to the 2023 Capital Improvements Budget. (\$21,493,900.00)

WHEREAS, three bids for Health Department Expansion Renovation Project were received and publicly opened in the office of the Director of Finance and Management on June 5, 2023; and

WHEREAS, the bid from 2K General Company was deemed the lowest, best, most responsive and responsible bid in the amount of \$21,493,900.00; and

WHEREAS, a waiver of provisions of Columbus City Code, Chapter 378 in regards to approval by the Community Benefits Agreement Advisory Committee is being requested to allow the Director of Finance and Management to award a construction contract to 2K General Company for the Health Department Expansion Renovation Project; and

WHEREAS, it is necessary to authorize transfers and expenditures within the Safety Voted Capital Fund - Fund No. 7701, the Health General Obligations Bond Fund - Fund No. 7706, and the Construction Management Capital Improvement Fund - Fund No. 7733; and

WHEREAS, it is necessary to authorize an amendment to the 2023 Capital Improvements Budget for the purpose of providing sufficient spending authority for the aforementioned project expenditures; and

WHEREAS, it has become necessary in the usual daily operation of the Department of Finance and Management, Office of Construction Management, to authorize the Director of Finance and Management to enter into a construction contract with 2K General Company for the Health Department Expansion Renovation Project; for the preservation of the public Safety, peace, property and safety; **NOW, THEREFORE**,

BE IT ORDAINED BY THE COUNCIL OF THE CITY OF COLUMBUS:

SECTION 1. That the Director of Finance and Management is hereby authorized to enter into a construction contract, on behalf of the Office of Construction Management, with 2K General Company, for the Health Department Expansion Renovation Project, in an amount up to \$21,493,900.00.

SECTION 2. That this Council finds it in the best interest of the City to waive the provisions of Columbus City Codes, Chapter 378 in regards to approval by the Community Benefits Agreement Advisory Committee.

SECTION 3. That the transfer of \$20,334.74, or so much thereof as may be needed, is hereby authorized within Fund 7701 (Safety General Obligation Bond Fund), Dept/Div 4550 (Construction Mgmt.), per the account codes in the attachment to this ordinance.

SECTION 4. That the transfer of \$18,148.83, or so much thereof as may be needed, is hereby authorized within Fund 7706 (Health G.O. Bond Fund), Dept/Div 4550 (Construction Mgmt.) and Dept/Div 5001 (Health), per the account codes in the attachment to this ordinance.

SECTION 5. That the transfer of \$1,181,274.00, or so much thereof as may be needed, is hereby authorized within Fund 7733 (Construction Mgmt. Capital Improvement Fund), Dept/Div 4550 (Construction Mgmt.), per the account codes in the attachment to this ordinance.

SECTION 6. That the expenditure of \$20,334.74, or so much thereof as may be needed, is hereby authorized within the Safety General Obligation Bond Fund - Fund No. 7701, per the account codes in the attachment to this ordinance.

SECTION 7. That the expenditure of \$20,289,751.83, or so much thereof as may be needed, is hereby

authorized within the Health G.O. Bonds Fund - Fund No. 7706, per the account codes in the attachment to this ordinance.

SECTION 8. That the expenditure of \$ \$1,183,813.43, or so much thereof as may be needed, is hereby authorized within the Construction Mgmt. Capital Improvement Fund - Fund No. 7733, per the account codes in the attachment to this ordinance.

SECTION 9. That the 2023 Capital Improvements Budget is hereby amended per the accounting codes in the attachment to this ordinance.

SECTION 10. Funds are hereby deemed appropriated and expenditures and transfers authorized to carry out the purposes of this ordinance and the City Auditor shall establish such accounting codes as necessary.

SECTION 11. That the City Auditor is authorized to make any accounting changes to revise the funding source for all contracts or contract modifications associated with this ordinance.

SECTION 12. That the City Auditor is hereby authorized to transfer the unencumbered balance in a project account to the unallocated balance account within the same fund upon receipt of certification by the Director of the Department administering said project that the project has been completed and the monies are no longer required for said project.

SECTION 13. That this Ordinance shall take effect and be in force from and after the earliest period allowed by law.

Legislation Number: 1998-2023

Drafting Date: 6/27/2023

Version: 1

Current Status: Passed

Matter Type: Ordinance

BACKGROUND: The purpose of this legislation is to authorize the Director of the Department of Finance and Management to enter into a contract with White Oak Environmental & Safety for the purchase of Blackline Gas Detectors and Accessories for the Division of Sewerage and Drainage. The Blackline Gas Detectors will be used at the Southerly Wastewater Treatment Plant to detect combustible, flammable and toxic gases.

The Purchasing Office advertised and solicited competitive bids in accordance with the relevant provisions of City Code Chapter 329 relating to competitive bidding (RFQ025002). One hundred (100) vendors (6 EBE, 1 EBE/VBE, 2 WBE, 91 MAJ) were solicited and four (4) majority bids were received and opened on June 22, 2023.

After a review of the bids, the Division of Sewerage and Drainage recommends the award be made for all items to White Oak Environmental & Safety as the overall lowest, responsive, responsible and best bidder.

The company is not debarred according to the Excluded Party Listing System of the Federal Government or prohibited from being awarded a contract according to the Auditor of State Unresolved Findings for Recovery Certified Search.

SUPPLIER: White Oak Environmental & Safety, vendor #032967, pending

FISCAL IMPACT: \$93,389.00 has been budgeted for this purchase.

\$0.00 was expended in 2022
\$0.00 was expended in 2021.

To authorize the Director of the Department of Finance and Management to enter into a contract with White Oak Environmental & Safety for the purchase of a Blackline Gas Detectors and Accessories for the Division of Sewerage and Drainage; and to authorize the expenditure of \$93,389.00 from the Division of Sewer Operating Fund; (\$93,389.00)

WHEREAS, the Purchasing Office opened formal bids on June 22, 2023 for the purchase of Blackline Gas Detectors and Accessories for the Division of Sewerage and Drainage; and

WHEREAS, the Division of Sewerage and Drainage recommends an award be made to the overall lowest responsive, responsible and best bidder White Oak Environmental & Safety for all items; and

WHEREAS, the Southerly Wastewater Treatment Plant will use the Blackline Gas Detectors to detect combustible, flammable and toxic gases; and

WHEREAS, this ordinance authorizes the expenditure of \$93,389.00, or so much thereof as may be needed, for the purchase of mobile vehicle column lifts; and

WHEREAS, it has become necessary in the usual daily operation of the Department of Public Utilities to authorize the Director of Finance and Management to enter into a contract with White Oak Environmental & Safety in accordance with the terms, conditions and specifications of Solicitation Number RFQ025002 on file in the Purchasing Office; **now, therefore,**

BE IT ORDAINED BY THE COUNCIL OF THE CITY OF COLUMBUS:

SECTION 1. That the Director of the Department of Finance and Management be and is hereby authorized to enter into a contract with White Oak Environmental & Safety for the purchase of Blackline Gas Detectors and Accessories in accordance with RFQ025002 specifications on file in the Purchasing Office.

SECTION 2. That the expenditure of \$93,389.00, or as much thereof as may be needed, is hereby authorized in Fund 6100 (Sewer Operating Fund); in Object Class 02 Materials and Supplies per the accounting codes in the attachment to this ordinance.

SECTION 3. That the funds necessary to carry out the purpose of this ordinance are hereby deemed appropriated, and the City Auditor shall establish such accounting codes as necessary.

SECTION 4. That the City Auditor is authorized to make any accounting changes to revise the funding source for all contracts or contract modifications associated with this ordinance.

SECTION 5. That this Ordinance shall take effect and be in force from and after the earliest period allowed by law.

Legislation Number: 2006-2023

Drafting Date: 6/28/2023

Current Status: Passed

Version: 1

Matter Type: Ordinance

BACKGROUND: The Office of CelebrateOne has been awarded funds from the Central Ohio Hospital Council on behalf of Ohio Better Birth Outcomes for \$100,000.00 for the time period of July 1, 2022 through June 30, 2024. This ordinance is needed to accept and appropriate \$100,000.00 in grant money to support the operational capacity of CelebrateOne.

FISCAL IMPACT: The program activity is funded by the Central Ohio Hospital Council, on behalf of Ohio Better Birth Outcomes and does not generate revenue nor require a City match. Private Grant Fund 2291 To authorize and direct the Office of CelebrateOne to accept funds from the Central Ohio Hospital Council on behalf of Ohio Better Birth Outcomes, in the amount of \$100,000.00 to support operational capacity of CelebrateOne; and to authorize the appropriation of \$100,000.00 to the City's Private Grants Fund 2291. (\$100,000.00)

WHEREAS, \$100,000.00 in grant funds have been made available to the Office of CelebrateOne through the Central Ohio Hospital Council, on behalf of Ohio Better Birth Outcomes; and,

WHEREAS, this ordinance is submitted as an emergency so as to allow the financial transaction to be posted in the City's accounting system as soon as possible to meet grant deliverables; and

WHEREAS, it has become necessary in the usual daily operation of the Office of CelebrateOne that it is necessary to authorize the acceptance of this grant from the Central Ohio Hospital Council on behalf of Ohio Better Birth Outcomes, and to appropriate these funds to the Office of CelebrateOne, for the preservation of the public health, peace, property, and safety; **now, therefore**

BE IT ORDAINED BY THE COUNCIL OF THE CITY OF COLUMBUS:

SECTION 1. That the Office of CelebrateOne is hereby authorized and directed to accept a grant award of \$100,000.00 from the Central Ohio Hospital Council on behalf of the Ohio Better Birth Outcomes collaborative for the time period of July 1, 2022-June 30, 2024.

SECTION 2. That from the unappropriated monies in the Fund known as the City's Private Grants Fund, Fund No. 2291, and from all monies estimated to come into said Fund from any and all sources and unappropriated for any other purpose during the grant period, the sum of \$100,000.00, and any eligible interest earned during the grant period, is hereby appropriated upon receipt of an executed grant agreement in Fund 2291, to the Office of CelebrateOne, Division No. 40-05, per the accounting codes attached to this ordinance

SECTION 3. That the monies appropriated in the foregoing Section 2 shall be paid upon the order of the Office of the Mayor, and that no order shall be drawn or money paid except by voucher, the form of which shall be approved by the City Auditor.

SECTION 4. At the end of the grant period, any repayment of unencumbered balances required by the grantor is hereby authorized and any unused City match monies may be transferred back to the City fund from which they originated in accordance with all applicable grant agreements.

SECTION 5. That the funds necessary to carry out the purpose of this ordinance are hereby deemed

appropriated, and the City Auditor shall establish such accounting codes as necessary.

SECTION 6. That the City Auditor is authorized to make any accounting changes to revise the funding source for all contracts or contract modifications associated with this ordinance.

SECTION 7. That this ordinance shall take effect and be in force from and after the earliest period allowed by law.

Legislation Number: 2011-2023

Drafting Date: 6/28/2023

Current Status: Passed

Version: 1

Matter Type: Ordinance

BACKGROUND

This legislation amends Ordinance No. 3296-2022, passed on December 12, 2022, to appropriate additional funds to the grant agreement with Columbus Housing Partnership, Inc. (aka "Homeport") for Easton Place Homes Phase II development. This amendment also authorizes the filing of a restrictive covenant for the project, allowing for some units to be utilized for the City's HOME match requirement which is an obligation for the City's HOME entitlement allocation. Additionally, Columbus Housing Partnership, Inc., may assign some or all duties and responsibilities under the bond agreement to the project owner, Easton Loop Apartments II, LLC.

The original Ordinance No. 1821-2022 passed on July 11, 2022, authorized the Director to enter into a Housing Development Agreement for the total contract amount of \$4,800,000.00 and a grant agreement for \$2,250,000.00 coming from the 2021 Capital Budget with Easton Loop Apartments II, LLC. Upon further discussion, the correct recipient should have been the Columbus Housing Partnership, Inc., (aka "Homeport"), so an amendment to the original ordinance was established and was authorized by Ordinance No. 2484-2022 passed on September 19, 2022.

The original ordinance established an ACPO007959 in the amount of \$2,250,000.00 utilizing Affordable Housing bond funds coming from the 2021 Capital Budget. A second amendment, authorized by Ordinance No. 3296-2022, passed on December 12, 2022, provided the remaining \$2,550,000.00 from the City's 2022 Capital Budget through a bond agreement funded temporarily with the Special Income Tax Fund until bonds could be issued (the "Bond Funded Grant Agreement").

This ordinance authorizes an amendment to allow the establishment of an additional amount of \$1,250,000.00 from the City's 2023 Capital Budget ("Third Amendment"), bringing the total amount of established funds to \$6,050,000.00; \$2,250,000.00 coming from the 2021 Capital Budget, \$2,550,000.00 coming from the 2022 Capital Budget, and \$1,250,000.00 from the 2023 Capital Budget (collectively, the "Project Costs").

This ordinance also will authorize the filing of a restrictive covenant with the project, allowing for some units to be utilized for the City's HOME match requirement which is an obligation for the City's HOME entitlement allocation. The Lender, Columbus Housing Partnership Inc., may assign some or all duties and responsibilities under the Bond Funded Grant Agreement to the project owner, Easton Loop Apartments II, LLC, as necessary.

Easton Place Homes Phase II is a proposed 100-unit apartment development for families located at Easton Square Place and Charter Oak Way in Columbus, Ohio. The 4.65-acre parcel will be split to create lots on which approximately 200 units of affordable housing will be developed in three phases. Easton Place Homes Phase II is located directly south of the market rate townhomes facing Easton Way, which is the southern boundary of the premier retail/restaurant/entertainment district in Columbus. Major employers, such as JPMorgan Chase and Huntington Bank, employ thousands within walking distance-census data from 2018 indicates 24,000 jobs within a mile of the site-making this an extremely convenient location in all respects.

The property will consist of four 3-story apartment buildings with a combination of townhomes and stacked flats. Easton Place Phase II will offer a mix of 24 one-bedroom, 59 two-bedroom, and 17 three-bedroom

apartments. Community space includes a community room with kitchenette, fitness room and management office. Easton Place will serve a mix of income levels from 30% AMI to 60% AMI (the "Easton Phase II Project"). Depending on final utility allowances, net rents for the different unit sizes are estimated at \$360-830 for one-bedroom, \$430-995 for two-bedroom and \$485-1135 for three-bedroom apartments.

Easton Place Homes is owned and developed by Homeport (aka Columbus Housing Partnership, Inc.) and The Georgetown Company. Homeport is a non-profit housing developer based in Columbus, Ohio. Since its inception in 1987, Homeport has given greater security, opportunity and dignity to thousands of low income people by building quality, affordable homes, primarily financed with private investment leveraged by Federal tax credits. Homeport has established itself as the largest locally focused nonprofit producer of affordable housing and related services in the region. For more than 30 years Homeport has participated in the development, sale or preservation of more than 4,000 units of housing in Central Ohio.

Emergency justification is requested for this ordinance as this project is scheduled to close its financing and start construction in early September. In order to close its financing, other sources want to see all funds firmly committed, including City funding. City funding cannot be firmly committed if this ordinance passes as not effective until 30 days after the Mayor signs. Delaying the closing results in additional carrying costs to the project, the threat of additional construction cost increases that are not budgeted for, fewer days of good weather to allow for outside work to be accomplished before winter weather sets in that will in turn result in additional carrying costs and the threat of additional construction costs increases. Approximately 81% of the total development cost is covered with equity generated from the low income housing tax credits awarded by the State to the project. The pricing of credits is dependent on market conditions including an estimated completion and rent up date. If the project is delayed in closing its financing and starting construction, it may have to pay a credit adjuster to the equity investor for late completion causing additional financial harm to the project.

CONTRACT COMPLIANCE: the vendor number is 004842 and expires 03/14/24.

FISCAL IMPACTS

This ordinance authorizes an expenditure of \$1,250,000.00 in the Affordable Housing Bond Fund. An amendment to the 2023 Capital Improvement Budget is required to establish sufficient budget authority within the proper project.

To amend Ordinance No. 3296-2022 to authorize the additional expenditure of \$1,250,000.00 to Columbus Housing Partnership, Inc., (aka "Homeport") for the Easton Place Homes Phase II development (the "Project"); to amend the 2023 Capital Improvement Budget; to authorize the City Auditor to transfer funds within the Affordable Housing Bond Fund; to authorize a third amendment to the Bond Funded Grant Agreement; to authorize the filing of a restrictive covenant on the Project; to authorize the assignment of some or all duties and responsibilities under the Bond Funded Grant Agreement to the project owner; and to declare an emergency. (\$1,250,000.00)

WHEREAS, the original Ordinance No. 1821-2022 passed on July 11, 2022, authorized the Director of Development ("Director") to enter into an agreement with the Columbus Housing Partnership, Inc., ("Developer") for the total contract amount of \$4,800,000.00, and authorized a grant agreement ("Bond Funded Grant Agreement") with the Developer in the amount of \$2,250,000.00, funded from the 2021 Capital Budget; and

WHEREAS, the second Ordinance, No. 3296-2022, authorized the Director of Development to amend the

Bond Funded Grant Agreement with the Columbus Housing Partnership, Inc., for the Easton Place Homes Phase II development, and authorized the expenditure of \$2,550,000.00 from the City's 2022 Capital Budget; and

WHEREAS, it is necessary to amend Ordinance No. 3296-2022 to authorize an additional expenditure of \$1,250,000.00; to amend the Bond Funded Grant Agreement for the third time; and to amend the 2023 Capital Improvement Budget for the same; and

WHEREAS, this third amendment also authorizes the filing of a restrictive covenant for the Project, allowing for some units to be utilized for the City's HOME match requirement which is an obligation for the City's HOME entitlement allocation; and

WHEREAS, Easton Place Homes Phase II is a proposed 100-unit apartment development for families located at Easton Square Place and Charter Oak Way in Columbus, Ohio, and will offer a mix of 24 one-bedroom, 59 two-bedroom, and 17 three-bedroom apartments ("Project"); and

WHEREAS, the Project will consist of four 3-story apartment buildings with a combination of town-homes and stacked flats. Easton Place Phase II will offer a mix of 24 one-bedroom, 59 two-bedroom, and 17 three-bedroom apartments. Community space includes a community room with kitchenette, fitness room and management office. Easton Place will serve a mix of income levels from 30% AMI to 60% AMI. Depending on final utility allowances, net rents for the different unit sizes are estimated at \$360-830 for one-bedroom, \$430-995 for two-bedroom and \$485-1135 for three-bedroom apartments.

WHEREAS, in addition to the City's Capital funds, Phase II has also secured 4% tax credits from OHFA in 2021, along with OHFA HDAP, and County HOME funds and other private loans; and

WHEREAS, it is necessary to amend the 2023 Capital Improvement Budget to establish authority within the correct project; and

WHEREAS, an emergency exists in the usual daily operation of the Department of Development in that it is immediately necessary to amend ordinance 3296-2022 as this project is scheduled to close its financing and start construction in early September. In order to close its financing, other sources want to see all funds firmly committed, including City funding. City funding cannot be firmly committed if this ordinance passes as not effective until 30 days after the Mayor signs. Delaying the closing results in additional carrying costs to the project, the threat of additional construction cost increases that are not budgeted for, fewer days of good weather to allow for outside work to be accomplished before winter weather sets in that will in turn result in additional carrying costs and the threat of additional construction costs increases. Approximately 81% of the total development cost is covered with equity generated from the low income housing tax credits awarded by the State to the project. The pricing of credits is dependent on market conditions including an estimated completion and rent up date. If the project is delayed in closing its financing and starting construction, it may have to pay a credit adjuster to the equity investor for late completion causing additional financial harm to the project, all for the preservation of the public health, peace, property, safety, and welfare; **NOW, THEREFORE**,

BE IT ORDAINED BY THE COUNCIL OF THE CITY OF COLUMBUS:

SECTION 1. That the 2023 Capital Improvements Budget authorized by Ordinance No. 1711-2023 be amended as follows to establish sufficient authority for this Third Amendment to the Bond Funded Grant Agreement:

Fund / Project / Project Name / Current / Change /C.I.B. as Amended

7779 / P782012-100000 / Affordable Housing Funds / 1,760,000.00/ (\$1,250,000.00) / \$510,000.00

7779 / P782035-100000 / Easton Place Homes II / \$0.00 / \$1,250,000.00 / \$1,250,000.00

SECTION 2. That the transfer of \$1,250,000.00 or so much thereof as may be needed, is hereby authorized within Fund 7779 (Affordable Housing Bond fund), Dept-Div 44-10 (Housing) per the account codes in the attachment to this ordinance.

SECTION 3. That the expenditure of \$1,250,000.00 to the Columbus Housing Partnership, Inc, or so much thereof as may be needed, is hereby authorized in Fund 7779 (Affordable Housing Taxable Bond Fund), Dept-Div 44-10 (Housing Division), in object class 06 (Capital Outlay) per the accounting codes in the attachment to this ordinance, and that the Director of the Department of Development is authorized to enter into a Third Amendment to the Bond Funded Grant Agreement to increase the funding as provided hereunder.

SECTION 4. That Section 3 of Ordinance No. 3296-2022 be amended to transfer \$3,800,000.00.

SECTION 5. That Section 4 of Ordinance No. 3296-2022 be amended to authorize a grant agreement totaling \$3,800,000.00.

SECTION 6. That Section 5 of Ordinance No. 3296-2022 be amended to authorize an expenditure totaling \$3,800,000.00.

SECTION 7. That the filing of a restrictive covenant for the Project is authorized, allowing for some units to be utilized for the City's HOME match requirement which is an obligation for the City's HOME entitlement allocation.

SECTION 8. That the Columbus Housing Partnership, Inc., is authorized to assign some or all duties and responsibilities under the Bond Funded Grant Agreement to the project owner, Easton Loop Apartments II, LLC.

SECTION 9. That the funds necessary to carry out the purpose of this ordinance are hereby deemed appropriated, and the City Auditor shall establish such accounting codes as necessary.

SECTION 10. That the City Auditor is hereby authorized to transfer the unencumbered balance in a project account to the unallocated balance account within the same fund upon receipt of certification by the Director of the Department administering said project that the project has been completed and the monies are no longer required for said project.

SECTION 11. That the City Auditor is authorized to make any accounting changes to revise the funding source for all contracts or contract modifications associated with this ordinance.

SECTION 12. That for the reasons stated in the preamble hereto, which is hereby made a part hereof, this Ordinance is hereby declared to be an emergency measure and shall take effect and be in force from and after its approval by the Mayor, or ten days after passage if the Mayor neither approves nor vetoes the same.

Legislation Number: 2041-2023

Drafting Date: 6/29/2023

Version: 1

Current Status: Passed

Matter Type: Ordinance

The Civil Service Commission is requesting approval to modify the current contract with Mount Carmel Health Providers, Inc., increasing the maximum authorized expenditure for pre-employment physicals and

cardiovascular stress testing of public safety recruits in preparation for upcoming Police and Fire Academy classes.

The Civil Service Commission is requesting approval to modify the current contract with Mount Carmel Health Providers, Inc., increasing the maximum authorized expenditure in order to avail funds for upcoming medical screening services. Funding is typically added two to three times each budget year prior to the start of academy class, rather all at one time at the beginning of the year, so as to not tie-up City funds prematurely or unnecessarily. For this second requested modification, we are requesting an increase of \$70,000.00 to the current \$240,000.00, previously authorized, for a new total 2023 appropriation of \$310,000.00.

Bid Information: In 2022, the City of Columbus Civil Service Commission published a Request for Proposals (RFQ 023538) for these services and accepted proposals through December 2, 2022. Three proposals were submitted by the deadline. An evaluation committee reviewed these proposals in accordance with the criteria set forth in the RFQ and the Executive Director selected and executed a contract with the selected vendor, Mount Carmel Health Providers, Inc., via Ordinance 3084-2022 followed by a first modification via Ordinance 0776-2023. Because the resulting contract with Mount Carmel Health Providers, Inc. is valid through 2025, if renewed by the City, re-bidding for these services at this time is not required or needed. Pricing for these services were determined via the RFQ process and were subsequently memorialized in the contract with the vendor.

Contract Compliance Number: CC005227, expires 10/4/2023.

FISCAL IMPACT: Funding for this wave of services is budgeted in the Civil Service Commission's 2023 General Fund budget.

To authorize the Executive Director of the Civil Service Commission to modify the current contract with Mount Carmel Health Providers, Inc. for the administration of pre-employment physicals and cardiovascular stress testing of public safety recruits; to authorize the additional expenditure of \$70,000.00 from the General Fund (\$70,000.00).

WHEREAS, the City of Columbus Civil Service Commission accepted proposals from qualified companies for medical services; and

WHEREAS, the Civil Service Commission awarded the contract to Mount Carmel Health Providers, Inc. based upon the submissions of RFQ 023538; and

WHEREAS, Two Hundred Forty Thousand Dollars (\$240,000.00) have been previously authorized to Mount Carmel Health Providers for the pre-employment physicals and cardiovascular stress testing of public safety recruits services per Ordinances 3084-2022 and 0776-2023; and

WHEREAS it is now necessary to modify and increase the current contract with Mount Carmel Health Providers, Inc. in order to continue scheduling public safety recruits in preparation for upcoming academy classes; and; **now therefore:**

BE IT ORDAINED BY THE COUNCIL OF THE CITY OF COLUMBUS:

SECTION 1. That the Executive Director of the Civil Service Commission be and is hereby authorized to modify and increase the current contract with Mount Carmel Health Providers, Inc. for the purpose of administering pre-employment physicals and cardiovascular stress tests to public safety recruits for the Department of Public Safety's police and fire entry-level sworn positions.

SECTION 2. That the additional expenditure of \$70,000.00 (for a new total authorization of \$310,000.00 to Mount Carmel Health Providers, Inc.), or so much thereof as may be needed, is hereby authorized in Fund 1000 General Fund in Object Class 03 per the accounting codes in the attachment to this ordinance.

SECTION 3. That the funds necessary to carry out the purpose of this ordinance are hereby deemed appropriated, and the City Auditor shall establish such accounting codes as necessary.

SECTION 4. That the City Auditor be and is hereby authorized to establish an Auditor's Certificate on behalf of the Civil Service Commission for the administration of pre-employment physicals and cardiovascular stress testing of public safety recruits.

SECTION 5. That the City Auditor is authorized to make any accounting changes necessary to ensure that these expenditures are properly accounted for and recorded accurately on the City's financial records.

SECTION 6. That this ordinance shall take effect and be in force from and after the earliest period allowed by law.

Legislation Number: 2043-2023

Drafting Date: 6/29/2023

Version: 1

Current Status: Passed

Matter Type: Ordinance

BACKGROUND: To authorize the Director of Public Utilities to modify an Indefinite Quantity Agreement Contract with Deere Valley Farms for the Class B Liquid Biosolids Land Application Program to provide for services through March 31, 2024.

This contract provides the service of applying sewage sludge for agricultural purposes. The work generally shall include: the agronomic land application of up to 10% Total Solids (TS) liquid biosolids, tank pumping and cleaning services, the transport of 25% TS dewatered biosolids cake and transport of incinerator ash. The Contractor is responsible for professional management of the Land Application of Biosolids with Regional Storage program, which generally includes preparing site authorization requests, samples, daily activity reports, weekly progress reports, invoices and submitting this information to the City's Project Manager. The contract is utilized by the Southerly Wastewater Treatment Plant, Jackson Pike Wastewater Treatment Plant and the Compost Facility.

The Department of Public Utilities solicited competitive bids for the Class B Liquid Biosolids Land Application Program in accordance with the relevant provisions of Chapter 329 (RFQ022645). An Indefinite Quantity Agreement Contract was established and authorized under Ordinance #0114-2023.

This legislation seeks to modify the indefinite quantity contract to add funding to provide services through the current term of the contract. This Ordinance is being submitted in accordance with the relevant provisions of Chapter 329 of City Code pertaining to contract renewals/modifications.

SUPPLIER: Deere Valley Farms, vendor #043008, CC#31-1361699, expires 9/12/24, majority status

The company is not debarred according to the Excluded Party Listing System of the Federal Government or prohibited from being awarded a contract according to the Auditor of State Unresolved Findings for Recovery Certified Search.

1. Amount of additional funds: Total amount of additional funds needed for the indefinite quantity contract is \$562,515.00. Total contract amount including this modification is \$1,362,515.00.
2. Reasons additional funds were not foreseen: The need for additional funds was known at the time of the initial contract. This funding increase is to provide the additional funding necessary for the payment of services to be provided through March 31, 2024.
3. Reason other procurement processes were not used: Work under this modification is a continuation of services included in the scope of the original bid contract. No lower pricing/more attractive terms and conditions are anticipated at this time.
4. How cost was determined: The cost, terms and conditions are in accordance with the original agreement.

FISCAL IMPACT: \$562,515.00 is budgeted and needed for this purchase.

\$332,038.16 was spent in 2022

\$795,907.68 was spent in 2021

\$636,373.17 was spent in 2020

To authorize the Director of Public Utilities to modify an Indefinite Quantity Agreement Contract with Deere Valley Farms for the Class B Liquid Biosolids Land Application Program; and to authorize the expenditure of \$562,515.00 from the Sanitary Sewerage Operating Fund; (\$562,515.00)

WHEREAS, the Department of Public Utilities entered into an indefinite quantity contract for the Class B Liquid Biosolids Land Application Program with Deere Valley Farms in accordance with Chapter 329 of the Columbus City Code, pursuant to solicitation RFQ022645; and

WHEREAS, the vendor has agreed to modify to increase the indefinite quantity contract and current prices and conditions; and

WHEREAS, it has become necessary in the usual daily operation of the Department of Public Utilities to authorize the Director to modify an Indefinite Quantity Agreement Contract with Deere Valley Farms for the Class B Liquid Biosolids Land Application Program; **now, therefore,**

BE IT ORDAINED BY THE COUNCIL OF THE CITY OF COLUMBUS:

SECTION 1. That the Director of Public Utilities be and is hereby authorized to modify the Indefinite Quantity Agreement Contract for the Class B Liquid Biosolids Land Application Program with Deere Valley Farms per the terms and conditions of RFQ022645 on file in the Department of Public Utilities.

SECTION 2. That said firm shall conduct the work to the satisfaction of the Director of Public Utilities.

SECTION 3. This legislation seeks to modify the indefinite quantity contract to add funding to provide services through the current term of the contract. This Ordinance is being submitted in accordance with the relevant provisions of Chapter 329 of City Code pertaining to contract renewals/modifications.

SECTION 4. That the funds necessary to carry out the purpose of this ordinance are hereby deemed appropriated, and the City Auditor shall establish such accounting codes as necessary.

SECTION 5. That the expenditure of \$562,515.00 is authorized in Fund 6100 (Sanitary Sewer-Operating) in object class 03 Services per the accounting codes in the attachment to this ordinance.

SECTION 6. That this Ordinance shall take effect and be in force from and after the earliest period allowed by law.

Legislation Number: 2044-2023

Drafting Date: 6/29/2023

Current Status: Passed

Version: 1

Matter Type: Ordinance

Background: The Department of Development seeks to enter into a contract with Columbus Compact Corporation in an amount not to exceed \$150,000.00 to administer advising services for the Downtown Commercial Marketplace Program targeting small businesses.

The City of Columbus will launch a Downtown Commercial Marketplace Program to support up to ten existing businesses relocating or expanding to downtown Columbus to stimulate downtown commercial activity. The business advisor will assist the selected business in achieving financial success, measured through profit and loss statements through planning, counseling, and connecting businesses with other business development resources. The advisor will also be responsible for reaching out to neighboring small businesses to offer business counseling and to offer to connect the businesses to business development resources.

The Department utilized the Request for Proposals (RFP) process in accordance with City procurements standards to solicit proposals. Proposals were submitted in response to RFQ024861 in accordance with the relevant provisions of Chapter 329 of the Columbus City Codes.

After careful review, the Proposal Evaluation Committee selected Columbus Compact Corporation to administer advising services to small businesses participating in the Downtown Commercial Marketplace Program.

Columbus Compact aims to support businesses and economic development by creating assets. Currently, by providing small business development services for local business owners; and supporting central city revitalization by investing in the stabilization of real estate. Our overall objective is to assist in the capacity of Small Businesses (DBE/MBE/FBE/LMI); and empower them to achieve quantifiable and potentially sustainable growth.

As a non-profit, since 1995, the Columbus Compact dba Columbus Empowerment has a history of working with small businesses in general, a portion of which have been in the retail industry and a portion of which have been located downtown. Restructured in 2019, the Organization has continued to be an ESO providing direct services to small businesses throughout the City of Columbus, Franklin County, and contiguous counties through 1-1 advisement, including assessment, plan of action development, and workshops for starting, scaling, obtaining sustainability and expansion. Services include but are not limited to strategic business planning, obtaining financial resources, relocation, and private and public sector market expansion.

Fiscal Impact: Funding of \$150,000.00 is available within the Jobs Growth subfund.

CONTRACT COMPLIANCE: the vendor number is 032010; and expires 8/31/2024.

To authorize the Director of Development to enter into a contract with Columbus Compact Corporation, a non-profit organization, for business advising services for the Downtown Commercial Marketplace Program, to authorize an appropriation and expenditure of up to \$150,000.00 within the Jobs Growth subfund. (\$150,000.00)

WHEREAS, the City of Columbus is launching a Downtown Commercial Marketplace Program to support up to ten existing businesses to stimulate downtown commercial activity; and

WHEREAS, the Director of Development seeks to enter into a contract for a business advisor to administer advising services to businesses participating in the Downtown Commercial Marketplace Program; and

WHEREAS, the City of Columbus, utilized a Request for Proposals (RFP) process to identify and assess qualified firms; and

WHEREAS, proposals were submitted in response to RFQ024861 in accordance with the relevant provisions of Chapter 329 of the Columbus City Code, and Columbus Compact Corporation received the highest overall score from the RFP committee; **NOW, THEREFORE**

BE IT ORDAINED BY THE COUNCIL OF THE CITY OF COLUMBUS:

SECTION 1. That the Director of Development is hereby authorized to enter into a contract with Columbus Compact Corporation, a non-profit corporation, to administer business advising services for the Downtown Commercial Marketplace Program in the amount up to \$150,000.00 for a term of approximately eighteen months, expiring March 30, 2025 with the option to renew one (1) additional year.

SECTION 2. That the City Auditor be and is hereby authorized and directed to appropriate \$150,000.00 in Fund 1000 (General Fund), Subfund 100015 (Jobs Growth Subfund), Dept-Div 4402 (Economic Development), in Object Class 03 (Services), per the accounting codes in the attachment to this ordinance.

SECTION 3. That for the purpose as stated in Section 1, the expenditure of up to \$150,000.00, or so much thereof as may be needed, is hereby authorized in Fund 1000 (General Fund), Dept-Div 44-02 (Economic Development Division), in object class 03 (Services) per the accounting codes in the attachment to this ordinance.

SECTION 4. That the funds are hereby deemed appropriated to carry out the purposes of this ordinance and the City Auditor shall establish such accounting codes as necessary.

SECTION 5. That the City Auditor is authorized to make any accounting changes to revise the funding source for all contracts or contract modifications associated with this ordinance.

SECTION 6. That this ordinance shall take effect and be in force from and after the earliest period allowed by law.

Legislation Number: 2053-2023

Drafting Date: 6/30/2023

Version: 1

Current Status: Passed

Matter Type: Ordinance

In a continued effort to improve operational efficiencies, provide better services to the public, and to streamline government organization and communication, it was determined that the Department of Public Services needs to make updates to the existing Chapter 219, Chapter 919, and Title 21 of the Columbus City Codes 1959, as amended.

The purpose of this legislation is to enact, amend and repeal various sections of Chapter 219, Chapter 919, and Title 21 of the Columbus City Codes, 1959, as amended that address various inadequacies within the existing code while also providing greater flexibility for its enforcement in the future.

2. FISCAL IMPACT:

There is no direct fiscal impact associated with this code change.

To enact, amend, and repeal various sections of Chapter 219, Chapter 919, and Title 21 of the Columbus City Codes to improve operational efficiencies by updating the division's name, to give the director the ability to promulgate rules and regulations related to shared mobility devices, and to establish the collection of correct vehicle information, mobility zone number, and any other information required to complete a parking transaction.

WHEREAS, in a continued effort to improve operational efficiencies, provide better services to the public, and to streamline government organization and communication, it was determined that the Department of Public Services needs to make updates to the existing Chapter 219, Chapter 919, and Title 21 of the Columbus City Codes, as amended; and

WHEREAS, it is necessary to enact the following section of the Columbus City Codes: 2105.28; and

WHEREAS, it is necessary to amend and repeal the following existing sections of the Columbus City Codes: 219.01, 219.034, 919.23, 2150.01, 2150.02, 2150.04, 2150.05, 2150.10, 2151.04, 2155.04, 2155.05, 2155.055, 2155.11; **NOW, THEREFORE**,

BE IT ORDAINED BY THE COUNCIL OF THE CITY OF COLUMBUS:

SECTION 1. That Chapter 2105 of the Columbus City Codes is hereby amended by the enactment of new Section 2105.28 to read as follows per the attached word document:

Ordinance 2053-2023 - Proposed Code Changes -6.28.23

SECTION 2. That Sections 219.01, 219.034, 919.23, 2150.01, 2150.02, 2150.04, 2150.05, 2150.10, 2151.04, 2155.04, 2155.05, 2155.055, and 2155.11 are hereby amended to read as follows per the attached word document:

Ordinance 2053-2023 - Proposed Code Changes -6.28.23

SECTION 2. That existing Sections 219.01, 219.034, 919.23, 2150.01, 2150.02, 2150.04, 2150.05, 2150.10, 2151.04, 2155.04, 2155.05, 2155.055, and 2155.11 are hereby repealed as follows per the attached word document:

Ordinance 2053-2023 - Proposed Code Changes -6.28.23

SECTION 4. That this ordinance will take effect and be in force from and after the earliest period allowed by law.

Legislation Number: 2065-2023

Drafting Date: 6/30/2023

Current Status: Passed

Version: 1

Matter Type: Ordinance

BACKGROUND: The City receives annual grant allocations from the United States Department of Housing and Urban Development (HUD) Office of Community Planning and Development (CPD). These grants include the Community Development Block Grant (CDBG) program and the Housing Opportunities for Persons With AIDS (HOPWA) program. In acceptance of this funding, the City is required to comply with the provisions of the Uniform Administrative Requirements, Cost Principles, and Audit Requirements for Federal Awards (“Uniform Guidance”), as well as limitations on planning and administrative costs according to 24 CFR 570.200(g)(1). Grant funds are regularly reviewed by City staff and by HUD staff to monitor compliance with applicable regulations, and address any non-compliant grant expenditures and draws.

Internal review of financial records in 2022 identified ineligible CDBG expenditures, and based on available records at the time, the City authorized a return of funds to HUD in the amount of \$293,215.00 via ordinance 0526-2022. Further review of records shows that there is a balance of \$600.24 that was expended on the ineligible CDBG activity which must be returned to HUD as well.

HUD’s annual review of the 2022 Program Year revealed that grant funds from 2015 had been expended in excess of the 20% origin year expenditure limit for planning and administrative expenses, in the amount of \$192,559.94. In order to address the issue, the City must return this amount via wire transfer to the CDBG Line of Credit from the City's General Fund. These funds will be made available to be drawn for other eligible non-administrative expenditures. Following the return of funds, the City will draw available funds from grant year 2022 to reimburse the General Fund.

Internal review of HOPWA grant expenditures and financial records revealed a discrepancy between the grant year funding of a contract within the City’s financial system and the grant year drawn for contract expenditures from HUD’s financial system. Ordinance 0919-2022 authorized the Board of Health to enter into a subaward with Equitas Health for the provision of eligible HOPWA services for the period of January 1, 2022 to December 31, 2022, funded by the HOPWA 2020 grant award. The corresponding activities funded by that subaward, and the City staff costs of administering the award, were mistakenly set up in HUD’s IDIS grant management system using funds from the HOPWA 2021 grant award, and subsequently those funds were drawn to cover eligible program expenditures. In order to correct the mistake and ensure that the correct grant funds are applied to these expenditures, the HOPWA 2021 funds must be returned to HUD via wire transfer. HUD will then make the funds available to the City to be allocated to future HOPWA subawards. The City will correctly submit draw requests for HOPWA 2020 grant funds from HUD for the reimbursement of eligible HOPWA expenditures.

FISCAL IMPACT: This ordinance authorizes the transfer and expenditure of \$312,445.77 from the General Governments Grants fund to correct reimbursements for the HOPWA Program, and the expenditure of

\$193,160.18 from the City's General Fund to correct reimbursements for the CDBG Program. New reimbursements will be processed from HUD to cover the \$312,445.77 in HOPWA expenditures and \$192,559.94 of the CDBG expenditures, leaving only \$600.24 as the net cost to the General Fund, and no net cost to CDBG and HOPWA grant funds.

EMERGENCY DESIGNATION: Emergency action is requested to allow the financial transaction to be processed as soon as possible and to mitigate risk of potential penalties from untimely action.

To authorize the Director of Finance and Management to correct the transactions for the Community Development Block Grant (CDBG) program and Housing Opportunities for Persons With AIDS (HOPWA) program funded by the U.S. Department of Housing and Urban Development (HUD), in the amounts of \$600.24, \$192,559.94, and \$312,445.77 (total of \$505,605.95); to authorize the transfer of \$312,445.77 within the General Government Grants Fund; to authorize the expenditure of \$312,445.77 from the General Government Grants Fund; to authorize the transfer of \$193,160.18 within the General Fund; to authorize the expenditure of \$193,160.18 from the General Fund; and to declare an emergency. (\$505,605.95)

WHEREAS, the City received funds from the United States Department of Housing and Community Development (HUD) for the Community Development Block Grant (CDBG) program and Housing Opportunities for Persons With AIDS (HOPWA) program; and

WHEREAS, ordinance 0526-2022 authorized a return of funds based on expenditures and funds drawn from HUD on activities later found to be inconsistent with the regulatory cost principles in federal uniform guidance;

WHEREAS, City review of those previous returned funds identified a balance of \$600.24 that must be returned; and

WHEREAS, expenditures from the 2015 CDBG grant award were found to have exceeded the 20% origin year cap on planning and administrative costs; and

WHEREAS, internal City review identified HOPWA costs drawn from the incorrect funding source; and

WHEREAS, the City is required to return all funds that were drawn from HUD on ineligible activities, in excess of expenditure caps, or from the incorrect funding source; and

WHEREAS, the returned funds will be made available to the City by HUD, and corrections will be made to draw funds from eligible sources; and

WHEREAS, HUD's Instructions for Returning Funds to the Line of Credit and to U.S. Treasury guidance requires reimbursements to the Line of Credit to be made via wire transfer; and

WHEREAS, an emergency exists in the usual daily operation of the Department of Finance and Management in that it is immediately necessary to authorize the Director to return \$505,605.95 to mitigate risk of potential penalties from untimely action, for the preservation of the public health, peace, property, safety and welfare;

NOW, THEREFORE,

BE IT ORDAINED BY THE COUNCIL OF THE CITY OF COLUMBUS:

SECTION 1. That the Director of the Department of Finance and Management is hereby authorized to initiate correcting transactions totaling \$505,605.95 to return said funds to HUD.

SECTION 2. That the transfer of \$312,445.77, or so much thereof as may be needed, is hereby authorized within Fund 2220 General Government Grants Fund, from Dept-Div 5001, Object Class 03 to Dept-Div 5001, Object Class 05 per the accounting codes in the attachment to this ordinance.

SECTION 3. That the transfer of \$600.24, or so much thereof as may be needed, is hereby authorized within Fund 1000 General Fund, from Dept-Div 4501, Object Class 10 to Dept-Div 4801, Object Class 05 per the accounting codes in the attachment to this ordinance.

SECTION 4. That the transfer of \$192,559.94, or so much thereof as may be needed, is hereby authorized within Fund 1000 General Fund, from Dept-Div 4501, Object Class 10 to Dept-Div 4501, Object Class 05 per the accounting codes in the attachment to this ordinance.

SECTION 5. That for the purpose stated in Section 1, the expenditure of \$312,445.77 is hereby authorized in Fund 2220, per the accounting codes in the attachment to this ordinance.

SECTION 6. That for the purpose stated in Section 1, the expenditure of \$193,160.18 is hereby authorized in Fund 1000, per the accounting codes in the attachment to this ordinance.

SECTION 7. That the City Auditor is authorized to make any accounting changes to revise the funding source for all modifications associated with this ordinance.

SECTION 8. Funds are hereby deemed appropriated and expenditures and transfers authorized to carry out the purposes of this ordinance and the City Auditor shall establish such accounting codes as necessary.

SECTION 9. That, for the reasons stated in the Preamble hereto, which is hereby made a part hereof, this Ordinance is hereby declared to be an emergency measure and shall take effect and be in force from and after passage and approval by the Mayor or ten days after passage if the Mayor neither approves nor vetoes the same.

Legislation Number: 2074-2023

Drafting Date: 7/3/2023

Current Status: Passed

Version: 1

Matter Type: Ordinance

BACKGROUND: This legislation authorizes the Director of the Department of Development to modify the scope of services in a Subaward Grant Agreement with Community Shelter Board as additional needs have been determined since creating the program in 2021 and to extend the agreement term to June 30, 2025.

Original	\$4,905,000.00	Ord. 3304-2021 as amends Ord. 2577-2021
PO308322		
Mod 1	\$ 0.00	Ord. 2074-2023 (current)
Total	\$4,905,000.00	

Using federal American Rescue Plan (ARPA) funds, Community Shelter Board will now embed up to 28 (down from 38 in the original agreement) mental health specialists trained in crisis intervention on-site in homelessness programs to reduce deaths and violence, better support our vulnerable neighbors, and reduce police and ambulance runs. The locations for these services have expanded beyond just providing services in shelters to include, but not limited to, drop-in centers, day centers, permanent supportive housing properties, and other locations where services are provided to people experiencing homelessness. These locations will be defined by the Community Shelter Board, in consultation with the City of Columbus. In addition, laptop computers may be purchased for the sole use of these funded specialists. A partnership with the Crisis Prevention Institute and Southeast Inc will provide high-quality training, certification, and continuing education for these specialist positions, augmenting the professional mental health workforce in our community.

FISCAL IMPACT: No additional funding is necessary.

CONTRACT COMPLIANCE: the vendor number is 004795 and expires 01/09/2025.

To authorize the Director of the Department of Development to modify the scope of services in a Not for Profit Services Contract with Community Shelter and to extend the agreement term to June 30, 2025.
(\$0.00)

WHEREAS, the Director of the Department of Development executed a Not for Profit Services Contract with the Community Shelter Board to provide mental health specialists trained in crisis intervention on-site in homelessness programs to reduce deaths and violence, better support our vulnerable neighbors, and reduce police and ambulance runs; and

WHEREAS, the scope of services needs to be modified as additional needs have been determined since the creation of the program and the date needs to be extended to implement the expanded program **NOW**, **THEREFORE**,

BE IT ORDAINED BY THE COUNCIL OF THE CITY OF COLUMBUS:

SECTION 1. That the Director of the Department of Development is hereby authorized to modify the scope of services in the Not for Profit Services Contract with the Community Shelter Board and to extend the agreement term to June 30, 2025, for crisis intervention services.

SECTION 2: That this ordinance shall take effect and be in force from and after the earliest period allowed by law.

Legislation Number: 2077-2023

Drafting Date: 7/3/2023

Current Status: Passed

Version: 1

Matter Type: Ordinance

BACKGROUND: Columbus Public Health’s Environmental Health Division has been awarded a grant from the Ohio Environmental Protection Agency. This ordinance is needed to accept and appropriate \$50,000.00 in grant monies to fund the 2023 Water Pollution Control Loan Fund (WPCLF) grant program, for the period April 30, 2023 through December 31, 2024.

The WPCLF program was created to assist the residents of Ohio with the repair or replacement of failing septic systems in hopes to improve the overall water quality in the state. The program is providing financial assistance to low to moderate income homeowners with the repair or replacement of failing systems. Columbus Public Health will solicit and identify local homeowners in Columbus that meet the income eligibility criteria outlined in the program.

FISCAL IMPACT: The 2023 WPCLF program is entirely funded by the Ohio Environmental Protection Agency and does not generate revenue or require a City Match. (\$50,000.00)

To authorize and direct the Board of Health to accept a grant from the Ohio Environmental Protection Agency

in the amount of \$50,000.00 for the 2023 WPCLF program; to authorize the appropriation of \$50,000.00 and any additional funds from the unappropriated balance of the Health Department Grants Fund; and to authorize the City Auditor to transfer appropriations between object classes for the 2023 WPCLF program; (\$50,000.00)

WHEREAS, \$50,000.00 in grant funds have been made available to Columbus Public Health through the Ohio Environmental Protection Agency for the 2023 WPCLF program for the period of April 30, 2023 through December 31, 2024; and,

WHEREAS, it is necessary to accept and appropriate these funds from the Ohio Environmental Protection Agency for the 2023 WPCLF program to begin efforts to identify and replace/repair failing septic systems within the City of Columbus; and,

WHEREAS, the City may receive additional funds awarded from the Ohio Environmental Protection Agency for the support of the 2023 WPCLF program; and,

WHEREAS, it is necessary to accept and appropriate these additional funds from the Ohio Environmental Protection Agency for the support of the 2023 WPCLF program; and,

WHEREAS, it is necessary to allow the City Auditor to transfer appropriations between object classes for the 2023 WPCLF program as needed upon request by the Columbus Public Health department to carry out the purpose of the grant; **NOW, THEREFORE,**

BE IT ORDAINED BY THE COUNCIL OF THE CITY OF COLUMBUS:

SECTION 1. That the Board of Health is hereby authorized and directed to accept a grant award of \$50,000.00 from the Ohio Environmental Protection Agency for the 2023 WPCLF program for the period April 30, 2023 through December 31, 2024.

SECTION 2. That from the unappropriated monies and from all monies estimated to come into said fund from any and all sources and unappropriated for any other purpose during the fiscal year ended December 31, 2024, the sum of \$50,000.00 is appropriated to The Health Department Grants Fund, Fund 2251, Department of Health, Division 5001, per the account codes in the attachment to this ordinance.

SECTION 3. That the monies appropriated in the foregoing Section 2 shall be paid upon the order of the Health Commissioner and that no order shall be drawn or money paid except upon voucher, the form of which shall be approved by the City Auditor.

SECTION 4. At the end of the grant period, any repayment of unencumbered balances required by the grantor is hereby authorized and any unused City match monies may be transferred back to the City fund from which they originated in accordance with all applicable grant agreements.

SECTION 5. That the funds necessary to carry out the purpose of this ordinance are hereby deemed appropriated, and the City Auditor shall establish such accounting codes as necessary.

SECTION 6. That the Board of Health is hereby authorized and directed to accept any additional grant awards from the Ohio Environmental Protection Agency for the 2023 WPCLF program for the period April 30, 2023, through December 31, 2024.

SECTION 7. That from the unappropriated monies and from all monies estimated to come into said fund

from any and all sources and unappropriated for any other purpose during the fiscal year ended December 31, 2024, any additional awarded funds are appropriated in Fund 2251 according to notification of award or grant agreement by the grantor.

SECTION 8. That the City Auditor is hereby authorized to transfer appropriations between object classes for the 2023 WPCLF program as needed upon request by the Columbus Public Health department to carry out the purpose of the grant.

SECTION 9. That this Ordinance shall take effect and be in force from and after the earliest period allowed by law.

Legislation Number: 2081-2023

Drafting Date: 7/3/2023

Current Status: Passed

Version: 1

Matter Type: Ordinance

1. BACKGROUND

This ordinance authorizes the Director of Public Service to enter into contract with Strawser Paving Company for the Resurfacing - 2023 Project 2 and to provide payment for construction, construction administration and inspection services.

This contract repairs and resurfaces 71 city streets and constructs 333 - ADA curb ramps along those streets. The work consists of milling the existing pavement, overlaying with new asphalt concrete, minor curb replacement, and replacing identified curb and sidewalk areas associated with installing ADA curb ramps. The resurfacing work includes areas of full depth pavement repair. The project also includes street curb extensions for pedestrian enhancements, traffic calming and streets with only curb replacement, and other work as may be necessary to complete the contract in accordance with the plans and specifications set forth in the Bid Submittal Documents.

The estimated Notice to Proceed date is August 28, 2023. The project was let by the Office of Support Services through Vendor Services and Bid Express. Four bids were received on June 29, 2023, (all majority) and tabulated as follows:

<u>Company Name</u>	<u>Bid Amount</u>	<u>City/State</u>	<u>Majority/ODI Certification</u>
Strawser Paving Co, Inc.	\$11,978,041.26	Columbus, OH	Majority
Shelly and Sands, Inc.	\$12,011,658.90	Columbus, OH	Majority
Kokosing Construction Co, Inc.	\$12,021,783.13	Westerville, OH	Majority
Decker Construction Company	\$12,676,633.17	Columbus, OH	Majority

Award is to be made to Strawser Paving Company as the lowest responsive and responsible and best bidder for their bid of \$11,978,041.26. The amount of construction administration and inspection services will be \$1,078,023.71. The total legislated amount is \$13,056,064.97.

Searches in the System for Award Management (Federal) and the Findings for Recovery list (State) produced no findings against Strawser Paving Company.

As part of their bid Strawser Paving Company has proposed the following subcontractors to work on the project:

<u>Company Name</u>	<u>City/State</u>	<u>Majority/ODI Certification</u>
Griffin Pavement Striping	Columbus, OH	Majority
Bituminous Pavement Systems	Columbus, OH	Majority
The Paul Peterson Company	Columbus, OH	Majority
Axe Tree Service	Marysville, OH	Majority
Complete General	Columbus, OH	Majority
Mid-West Landscape	Columbus, OH	Majority
WL Markers	Columbus, OH	Majority
Pavement Technology	Cleveland, OH	Majority
JRS Hauling	Canal Winchester, OH	MBE
MPC Trucking	New Albany, OH	MBE
JST Enterprises	Bexley, OH	WBE
Hurts Trucking & Demolition	Columbus, OH	MBE

2. CONTRACT COMPLIANCE INFORMATION

The contract compliance number for Strawser Paving Company is CC006114 and expires 1/17/2025.

3. PRE-QUALIFICATION STATUS

Strawser Paving Company and all proposed subcontractors have met code requirements with respect to pre-qualification, pursuant to relevant sections of Columbus City Code Chapter 329.

4. FISCAL IMPACT

The Public Service funding for this project is budgeted within the 2023 Capital Improvements Budget, which has been approved by Council under Ordinance 1711-2023. The funds will not be available to Public Service until the proceeds of the bond sale are available. Therefore, it is necessary to certify the Public Service funds in the amount of \$13,056,064.97 against the Special Income Tax Fund, Fund 4430. An amendment to the 2023 Capital Improvements Budget is required to match cash received from the Special Income Tax Fund and also to establish sufficient budget authority for this project. Funds will need to be appropriated within the Special Income Tax fund and then transferred to the Streets and Highways Bond Fund where they will also need to be appropriated.

5. MINORITY AND WOMAN OWNED BUSINESS ENTERPRISE & SMALL LOCAL BUSINESS ENTERPRISE PROGRAM

This contract was bid with an anticipated City of Columbus MBE/WBE Program goal of 8% as assigned by the City’s Office of Diversity and Inclusion (ODI). After ODI’s review of the Utilization Plan and other related information the contractor submitted with their bid response, ODI has approved an MBE/WBE Program goal of 5.79% for this contract. Failure by the contractor to meet this goal subjects the contractor to the Penalties for Non-Compliance as described in the “City’s Minority and Women-Owned Business Enterprise & Small Local Business Enterprise Program Manual” and in the “City of Columbus MBE/WBE Program Special Provision” that were part of the bid documents for this contract.

6. EMERGENCY DESIGNATION

Emergency action is requested in order to meet the interim completion date of the project of November 30, 2023 to ensure the safety of the traveling public.

To amend the 2023 Capital Improvement budget; to authorize and direct the City Auditor to appropriate and transfer funds from the Special Income Tax Fund to the Streets and Highways Bond Fund; to appropriate funds within the Streets and Highways Bond Fund; to authorize the Director of Public Service to enter into contract with Strawser Paving Company for the Resurfacing - 2023 Project 2; to authorize the expenditure of up to \$13,056,064.97 from the Streets and Highways Bonds Fund for the project; and to declare an emergency. (\$13,056,064.97)

WHEREAS, the Department of Public Service is engaged in the Resurfacing - 2023 Project 2 project; and

WHEREAS, the work for this project consists of repair and resurfacing of 71 city streets and construction of 333 - ADA curb ramps along those streets. The work consists of milling the existing pavement, overlaying with new asphalt concrete, minor curb replacement, and replacing identified curb and sidewalk areas associated with installing ADA curb ramps. The resurfacing work includes areas of full depth pavement repair. The project also includes street curb extensions for pedestrian enhancements, traffic calming and streets with only curb replacement, and other work as may be necessary to complete the contract in accordance with the plans and specifications set forth in the Bid Submittal Documents; and

WHEREAS, Strawser Paving Company will be awarded the contract for the Resurfacing - 2023 Project 2 program; and

WHEREAS, the Department of Public Service requires funding to be available for the Resurfacing - 2023 Project 2 program for construction expense along with construction administration and inspection services; and

WHEREAS, it is necessary to amend the 2023 Capital Improvement Budget to establish authority within the correct project; and

WHEREAS, this contract opportunity was submitted to the City's Office of Diversity and Inclusion (ODI) for review and assignment of an MBE/WBE goal prior to bidding; and

WHEREAS, this contract was bid with an anticipated City of Columbus MBE/WBE Program goal of 8% as assigned by the City's Office of Diversity and Inclusion (ODI) and after ODI's review of the Utilization Plan and other related information the contractor submitted with their bid response, ODI has approved an MBE/WBE Program goal of 5.79% for this contract; and

WHEREAS, failure by the contractor to meet this goal subjects the contractor to the Penalties for Non-Compliance; and

WHEREAS, funds will need to be appropriated within Fund 4430 (Special Income Tax) and within Fund 7704 (Streets and Highways Bond Fund); and

WHEREAS, funds will need to be transferred from the Special Income Tax Fund to the Streets and Highways Bond Fund; and

WHEREAS, the City will reimburse the Special Income Tax Fund; and

WHEREAS, this transfer should be considered as a temporary funding method; and

WHEREAS, the aggregated principal amount of obligations which the City will issue to finance this project is presently expected not to exceed \$13,056,064.97; and

WHEREAS, the City anticipates incurring certain Original Expenditures (as defined in Section 1.150-2(c) of the Treasury Regulations (the "Treasury Regulations") promulgated pursuant to the Internal Revenue Code of 1986, as amended) with respect to the project described in this ordinance (the "Project"); and

WHEREAS, an emergency exists in the usual daily operation of the Department of Public Service in that it is immediately necessary to authorize the Director to enter into contract with Strawser Paving Company to meet

the interim completion date of November 30, 2023 to ensure the safety of the traveling public, all for the immediate preservation of the public health, peace, property, safety and welfare; and **now therefore**,

BE IT ORDAINED BY THE COUNCIL OF THE CITY OF COLUMBUS:

SECTION 1. That the 2023 Capital Improvements Budget authorized by ordinance 1711-2023 be amended as follows to establish sufficient authority for this project:

Fund / Project / Project Name / Current / Change / C.I.B. as Amended

7704 / P530282-100051 / Resurfacing - Resurfacing Projects (Voted 2019 Debt SIT Supported) / \$20,000,000.00 / (\$13,056,065.00) / \$6,943,935.00 (Certifying against the SIT)

7704 / P530282-922023 / Resurfacing - 2023 Project 2 (Voted 2019 Debt SIT Supported) / \$0.00 / \$13,056,065.00 / \$13,056,065.00

SECTION 2. That from the unappropriated monies and from all monies estimated to come into said fund from any and all sources and unappropriated for any other purpose during the fiscal year ended December 31, 2023, the sum of \$13,056,064.97 is appropriated in Fund 4430 (Special Income Tax), Dept-Div 2201 (City Auditor), in Object Class 10 (Transfer Out) per the account codes in the attachment to this ordinance.

SECTION 3. That the transfer of \$13,056,064.97, or so much thereof as may be needed, is hereby authorized from Fund 4430 (Special Income Tax), Dept-Div 2201 (City Auditor) to Fund 7704 (Streets and Highways Bond Fund), Dept-Div 5911 (Infrastructure Management) per the account codes in the attachment to this ordinance.

SECTION 4. That from the unappropriated monies and from all monies estimated to come into said fund from any and all sources and unappropriated for any other purpose during the fiscal year ended December 31, 2023, the sum of \$13,056,064.97 is appropriated in Fund 7704 (Streets and Highways Bond Fund), Dept-Div 5911 (Infrastructure Management), Project 530282-922023 (Resurfacing - 2023 Project 2), in Object Class 06 (Capital Outlay) per the account codes in the attachment to this ordinance.

SECTION 5 That the Director of Public Service be and is hereby authorized to enter into a construction services contract with Strawser Paving Company located at 1595 Frank Road, Columbus, OH, 43223, for the Resurfacing - 2023 Project 2 project in the amount of up to \$11,978,041.26 in accordance with the specifications and plans on file in the Office of Support Services, which are hereby approved; and to pay for necessary construction administration and inspection costs associated with the project up to a maximum of \$1,078,023.71.

SECTION 6 That the expenditure of \$13,056,064.97, or so much thereof as may be needed, is hereby authorized in Fund 7704 (Streets and Highways Bond Fund), Dept-Div 5911 (Infrastructure Management), Project 530282-922023 (Resurfacing - 2023 Project 2), in Object Class 06 (Capital Outlay) per the accounting codes in the attachment to this ordinance.

SECTION 7. That the monies appropriated in the foregoing Section 2 and Section 4 shall be paid upon order of the Director of Public Service and that no order shall be drawn or money paid except by voucher, the form of which shall be approved by the City Auditor.

SECTION 8. That upon obtaining other funds for this project for the Department of Public Service, the City Auditor is hereby authorized and directed to repay the Special Income Tax Fund the amount transferred under

Section 3.

SECTION 9. That the City intends that this ordinance constitute an "official intent" for purposes of Section 1.150-2(e) of the Treasury Regulations, and that the City reasonably expects to reimburse itself for certain Original Expenditures incurred with respect to the Project from the proceeds of obligations to be issued by the City in a principal amount currently estimated to be \$13,056,064.97 (the "Obligations").

The City intends to make a reimbursement allocation on its books for the Original Expenditures not later than eighteen months following the later to occur of the date of the Original Expenditure to be reimbursed or the date the Project for which such Original Expenditures were made is "placed in service" within the meaning of Treasury Regulations Section 1.150-2(c). Upon the issuance of the Obligations, the proceeds of such Obligations shall be used to reimburse the fund from which the advance for costs of the Project will be made.

SECTION 10. Funds are hereby deemed appropriated and expenditures and transfers authorized to carry out the purposes of this ordinance and the City Auditor shall establish such accounting codes as necessary.

SECTION 11. That the City Auditor is authorized to make any accounting changes to revise the funding source for all contracts or contract modifications associated with this ordinance.

SECTION 12. That the City Auditor is hereby authorized to transfer the unencumbered balance in a project account to the unallocated balance account within the same fund upon receipt of certification by the Director of the Department administering said project that the project has been completed and the monies are no longer required for said project.

SECTION 13. That for the reasons stated in the preamble hereto, which is hereby made a part hereof, this Ordinance is hereby declared to be an emergency measure and shall take effect and be in force from and after its passage and approval by the Mayor or ten days after passage if the Mayor neither approves nor vetoes the same.

Legislation Number: 2082-2023

Drafting Date: 7/3/2023

Current Status: Passed

Version: 1

Matter Type: Ordinance

BACKGROUND: To authorize the Director of Finance and Management, on behalf of the Department of Public Utilities, to enter into a contract with Brown Enterprise Solutions, LLC for the purchase of a Dell servers and tape drives to replace existing equipment for the Division of Sewerage and Drainage, Technical Engineering/SCADA Group at the Jackson Pike Wastewater Treatment Plant and the Sewer Maintenance Operations Center (SMOC).

The Purchasing Office advertised and solicited competitive bids in accordance with the relevant provisions of City Code Chapter 329 relating to competitive bidding (RFQ025057). One-hundred sixty-five (165) vendors (14 EBE, 1 EBE/VBE, 1 EBE/WBE, 7 MBE, 1 MBE/EBE, 3 MBE/WBE, 5 WBE, 133 MAJ) were solicited and two (2) majority bids were received and opened on June 29, 2023.

After a review of the bids, the Division of Sewerage and Drainage recommends an award be made for all items to Brown Enterprise Solutions, LLC in the amount of \$81,285.00 as the lowest, responsive and responsible bidder.

SUPPLIER: Brown Enterprise Solutions, LLC, Vendor#010668, CC# expires 12/31/23, MBE Status

The company is not debarred according to the Excluded Party Listing System of the Federal Government or prohibited from being awarded a contract according to the Auditor of State Unresolved Findings for Recovery Certified Search.

FISCAL IMPACT: \$81,285.00 was budgeted for this purchase.

\$136,612.45 was spent in 2022

\$ 28,149.11 was spent in 2021

To authorize the Director of the Department of Finance and Management to enter into a contract with Brown Enterprise Solutions, LLC for the purchase of a Dell servers and tape drives for the Division of Sewerage and Drainage; and to authorize the expenditure of \$81,285.00 from the Sanitary Sewer Operating Fund.
(\$81,285.00)

WHEREAS, the Technical Engineering/SCADA group has existing equipment that is nearing the end of its service life cycle; and

WHEREAS, the Purchasing Office opened formal bids on June 29, 2023 for the purchase of a Dell servers and tape drives; and

WHEREAS, the Division of Sewerage and Drainage recommends an award be made to the lowest, responsive and responsible bidder, Brown Enterprise Solutions, LLC; and

WHEREAS, it is necessary to authorize the expenditure of up to \$81,285.00 from the Sanitary Sewer Operating Fund; and

WHEREAS, it has become necessary in the usual daily operation of the Department of Public Utilities to authorize the Director of Finance and Management to enter into a contract with Brown Enterprise Solutions, LLC, in accordance with the terms, conditions and specifications of Solicitation Number: RFQ025057 on file in the Purchasing Office; **NOW, THEREFORE**,

BE IT ORDAINED BY THE COUNCIL OF THE CITY OF COLUMBUS:

SECTION 1. That the Director of Finance and Management be and is hereby authorized to enter into a contract with Brown Enterprise Solutions, LLC for the purchase of a Dell servers and tape drives for the Division of Sewerage and Drainage, in accordance with RFQ025057 specifications on file in the Purchasing Office.

SECTION 2. That the expenditure of \$81,285.00, or as much thereof as may be needed, is hereby authorized in Fund 6100 (Sanitary Sewer Operating); \$46,460.00 in Object Class 06 Capital Outlay and \$34,825.00 in Object Class 02 Materials & Supplies per the accounting codes in the attachment to this ordinance.

SECTION 3. That the funds necessary to carry out the purpose of this ordinance are hereby deemed

appropriated, and the City Auditor shall establish such accounting codes as necessary.

SECTION 4. That the City Auditor is authorized to make any accounting changes to revise the funding source for all contracts or contract modifications associated with this Ordinance.

SECTION 5. That this Ordinance shall take effect and be in force from and after the earliest period allowed by law.

Legislation Number: 2087-2023

Drafting Date: 7/5/2023

Current Status: Passed

Version: 1

Matter Type: Ordinance

BACKGROUND: Columbus Public Health has been awarded the International Overdose Awareness Day (IOAD) Grant from the Alcohol Drug and Mental Health (ADAMH) Board of Franklin County, for the Alcohol and Drug Services (ADS) Division. This ordinance is needed to accept and appropriate \$5,000.00 in grant money for the period of July 1, 2023 through September 30, 2023.

The purpose of this funding is to cover costs associated with the Columbus and Franklin County Addiction Plan's event for, "International Overdose Awareness Day", scheduled for August 31, 2023 at St. Stephen's Community Center from 12pm - 7pm.

This ordinance is submitted as an emergency as to allow the financial transaction to be posted in the City's accounting system as soon as possible to avoid forfeiture of grant funds.

FISCAL IMPACT: The International Overdose Awareness Day Grant is fully funded by the ADAMH Board of Franklin County and does not require a City match.

To authorize the Board of Health to accept a grant from the ADAMH Board of Franklin County in the amount of \$5,000.00; to authorize the appropriation of \$5,000.00 to the Health Department in the Health Department Grants Fund; and to declare an emergency. (\$5,000.00)

WHEREAS, \$5,000.00 in grant funds have been made available from the ADAMH Board of Franklin County for the International Overdose Awareness Day grant program for the period of July 1, 2023 through September 30, 2023; and

WHEREAS, it is necessary to accept and appropriate these funds from the ADAMH Board of Franklin County for the continued support of the International Overdose Awareness Day grant program; and

WHEREAS, the City may receive additional funds awarded from the ADAMH Board of Franklin County for the support of the International Overdose Awareness Day grant program; and

WHEREAS, it is necessary to allow the City Auditor to transfer appropriations between object classes for the International Overdose Awareness Day grant program as needed upon request by the Columbus Public Health department.; and

WHEREAS, an emergency exists in that it is immediately necessary to authorize the Board of Health to enter into a grant agreement with the ADAMH Board of Franklin County in order to avoid forfeiture of grant funds, such immediate action being necessary for the immediate preservation of the public health, peace, property, safety, and welfare, **NOW, THEREFORE**,

BE IT ORDAINED BY THE COUNCIL OF THE CITY OF COLUMBUS:

SECTION 1. That the Board of Health is hereby authorized and directed to accept funding of \$5,000.00 from the ADAMH Board of Franklin County for the International Overdose Awareness Day grant program for the period of July 1, 2023 through September 30, 2023.

SECTION 2. The auditor's office is authorized to adjust appropriations to match current awarded amounts per the attached template and authorized to adjust appropriations as required for future award amount changes from the grantor in the Health Department's Grants Fund, Fund No. 2251, and from all monies estimated to come into said Fund from any and all sources during the grant period, the sum of \$5,000.00 and any eligible interest earned during the grant period is hereby appropriated to the Health Department, Division No. 5001, according to the attached accounting document.

SECTION 3. That the monies appropriated in the foregoing Section 2 shall be paid upon the order of the Health Commissioner and that no order shall be drawn or money paid except upon voucher, the form of which shall be approved by the City Auditor.

SECTION 4. That, at the end of the grant period, any repayment of unencumbered balances required by the grantor is hereby authorized and any unused City match monies may be transferred back to the City fund from which they originated in accordance with all applicable grant agreements.

SECTION 5. That the funds necessary to carry out the purpose of this ordinance are hereby deemed appropriated, and the City Auditor shall establish such accounting codes as necessary.

SECTION 6. That the Board of Health is hereby authorized and directed to accept any additional grant awards from the ADAMH Board of Franklin County for the International Overdose Awareness Day grant program for the period of July 1, 2023 through September 30, 2023.

SECTION 7. That from the unappropriated monies and from all monies estimated to come into said fund from any and all sources and unappropriated for any other purpose during the fiscal year ended December 31, 2023 any additional awarded funds are appropriated in Fund 2251 according to notification of award or grant agreement by the grantor.

SECTION 8. That the City Auditor is hereby authorized to transfer appropriations between object classes for the International Overdose Awareness Day grant program as needed upon request by the Columbus Public Health department.

SECTION 9. That for reasons stated in the preamble hereto, which is hereby made a part hereof, this ordinance is hereby declared to be an emergency measure and shall take effect and be in force from and after its passage and approval by the Mayor, or ten days after passage if the Mayor neither approves nor vetoes the same.

Drafting Date: 7/5/2023

Current Status: Passed

Version: 1

Matter Type: Ordinance

This legislation authorizes the Director of the Department of Development to enter into a not-for-profit service agreement with the Legal Aid Society of Columbus in an amount up to \$1,500,000.00 in support of the Tenant Advocacy Project (TAP) to provide legal representation to residents facing an eviction.

Tenants with legal representation are much more likely to avoid an eviction judgment and keep possession of their homes than unrepresented tenants. In addition to these primary effects, a right to counsel offers several secondary benefits to defendants who are sued for eviction. Attorneys may be able to keep eviction filings off tenants' records, arrange for alternative housing, negotiate reasonable amounts of time for tenants to move out, reduce or eliminate money owed to the landlord, or help tenants apply for rental assistance.

With these dollars, The Legal Aid Society of Columbus will be able to staff additional TAP attorneys and support staff for an additional year. Because the Tenant Advocacy Project attorneys specialize in these services this cannot be provided by existing city employees.

Emergency Designation: Emergency action is requested to ensure that The Legal Aid Society of Columbus can immediately continue providing additional legal counsel at eviction court on behalf of Columbus residents facing eviction.

Fiscal Impact: Funds are available within the Public Safety Initiatives subfund to support this contract.

Contract Compliance: the vendor's vendor number is 006124 and is compliant through 3/28/24.

To authorize the Director of the Department of Development to enter into a not-for-profit service agreement with the Legal Aid Society of Columbus in an amount up to \$1,500,000.00 in support of the Tenant Advocacy Project (TAP) to provide legal representation to residents facing an eviction; to authorize an appropriation and expenditure within the Public Safety Initiative subfund; and to declare an emergency. (\$1,500,000.00)

WHEREAS, high eviction rates continue to cause financial insecurity for many residents of Columbus, resulting in a full docket of eviction filings, which are expected to continue into 2024; and,

WHEREAS, low-income residents in the City of Columbus are in need of legal services to assist them in eviction court and the Legal Aid Society of Columbus provides assistance in advocating on behalf of residents facing eviction; and,

WHEREAS, Columbus City Council is committed to the Legal Aid Society's Tenant Advocacy Project, which aims to keep residents in their homes, and provide legal counsel for residents facing an eviction; and,

WHEREAS, an emergency exists in the usual daily operation of the Department of Development in that it is immediately necessary to authorize the Director to enter into a not-for-profit service contract with the Legal Aid Society of Columbus to immediately continue providing additional legal counsel at eviction court on behalf of Columbus residents facing eviction, all for the immediate preservation of the public health, peace, property, safety and welfare; and **now therefore**,

BE IT ORDAINED BY THE COUNCIL OF THE CITY OF COLUMBUS:

SECTION 1: That the Director of the Department of Development is hereby authorized to enter into a not-for-profit service agreement with the Legal Aid Society of Columbus in support of the Tenant Advocacy Project to provide legal representation to residents facing an eviction.

SECTION 2: That the Auditor is hereby authorized and directed to appropriate \$1,500,000.00 to the Department of Development within the Public Safety Initiatives subfund, fund 1000, subfund 100016, in Services-03 per the accounting codes in the attachment to this ordinance.

SECTION 3: That per the action authorized by Section 1 of this ordinance, the expenditure of \$1,500,000.00 or so much thereof as may be needed is hereby authorized in the Public Safety Initiatives subfund, fund 1000, subfund 100016, per the accounting codes in the attachment to this ordinance.

SECTION 4: That the City Auditor is authorized to make any accounting changes to revise the funding source for all contracts or contract modifications associated with this legislation.

SECTION 5: That for reasons stated in the preamble hereto, which is hereby made a part hereof, this ordinance is declared to be an emergency measure and shall take effect and be in force from and after its passage and approval by the Mayor, or ten days after passage if the Mayor neither approves nor vetoes the same.

Legislation Number: 2091-2023

Drafting Date: 7/5/2023

Current Status: Passed

Version: 1

Matter Type: Ordinance

BACKGROUND: This ordinance authorizes the additional appropriation of \$137,958.53 in the existing Health Department’s Alcohol and Drug Services Division Grant Fund, Fund No. 2251, Performance Incentive Fund. This appropriation ordinance for Columbus Public Health grant fund allows for the continued operations of the Performance Incentive Fund grant program at the Health Department’s Alcohol and Drug Services Division.

FISCAL IMPACT: This grant project is funded through grant project revenues arising from billing to Medicaid and some value-based contracting incentive payments from grant funders.

This ordinance will authorize the City Auditor to appropriate the unencumbered cash balance of Project No. G508320 to support the staffing and purchase of supplies and services for the various grant programs of the Health Department’s Alcohol and Drug Services Division.

To authorize the appropriation for the Health Department’s Alcohol and Drug Services Division Grant Fund, Performance Incentive Fund, in various object classes, for the continued operations of the Performance Incentive Fund grant program; to authorize the Board of Health to appropriate and/or transfer any additional Performance Incentive Fund grant funds moving forward. (\$137,958.53)

WHEREAS, it is necessary to appropriate unencumbered cash funds for the Health Department’s Alcohol and Drug Services Division Grant Fund, Fund No. 2251, Performance Incentive Fund grant program to allow for the continued operations of the Performance Incentive Fund grant program in the Health Department; and

WHEREAS, revenues arising from billing to Medicaid through the Health Department’s Alcohol and Drug Services Division grant programs and value-based contracting incentive payments from the Alcohol, Drug, and Mental Health Board of Franklin County may be used to cover expenses on various Alcohol and Drug Services

Division grant programs; **Now, therefore:**

BE IT ORDAINED BY THE COUNCIL OF THE CITY OF COLUMBUS:

SECTION 1. That the Board of Health is hereby authorized and directed to appropriate the unencumbered cash balance of \$137,958.53 in the Health Department’s Alcohol and Drug Services Division Grant Fund, Fund No. 2251, Performance Incentive Fund.

SECTION 2. That from the monies in the fund known as the Health Department’s Alcohol and Drug Services Division Grant Fund, Fund No. 2251, Performance Incentive Fund, and from monies estimated to come into said fund from revenues arising from the billing to Medicaid through the Health Department’s Alcohol and Drug Services Division grant programs and value-based contracting incentive payments from the Alcohol, Drug, and Mental Health Board of Franklin County moving forward, there be and hereby are appropriated to the Health Department’s Alcohol and Drug Services Division Grant Fund, Fund No. 2251, Performance Incentive Fund, per the accounting codes attached to this ordinance, for use moving forward, and any eligible interest earned during the grant period:

TOTAL ADDITIONAL AMOUNT APPROPRIATED TO FUND 2251, PERFORMANCE INCENTIVE FUND IS: \$137,958.53

SECTION 3. That the monies appropriated in the foregoing Section 2 shall be paid upon the order of the Health Commissioner and that no order shall be drawn or money paid except upon voucher, the form of which shall be approved by the City Auditor.

SECTION 4. That the funds necessary to carry out the purpose of this ordinance are hereby deemed appropriated, and the City Auditor shall establish such accounting codes as necessary.

SECTION 5. That the City Auditor is authorized to make any accounting changes to revise the funding source for all contracts or contract modifications associated with this ordinance.

SECTION 6. That at the end of the grant period, any repayment of unencumbered balances required by the grantor is hereby authorized and any unused City match monies may be transferred back to the City fund from which they originated in accordance with all applicable grant agreements.

SECTION 7. That the City Auditor is hereby authorized to transfer between object classes and accept appropriations from the unencumbered cash balance for the Performance Incentive Fund grant program as needed upon request by the Columbus Public Health department.

SECTION 8. That the existing appropriations in the grant project in the Health Department’s Alcohol and Drug Services Division Grant Fund, Fund No. 2251, Performance Incentive Fund at July 1, 2023, are hereby re-appropriated to the same grant, object class and purpose originally authorized by the Council and that the outstanding encumbrances in that grant project at July 1, 2023, are hereby re-encumbered.

SECTION 9. That this ordinance shall take effect and be in force from and after the earliest period allowed by law.

Legislation Number: 2093-2023

Drafting Date: 7/5/2023

Current Status: Passed

Background: City Council passed Ordinance No. 3097-2015 (the “Original TIF Ordinance”) on December 14, 2015 that declared improvements to certain parcels of real property located in the City to be a public purpose, and established a non-school tax increment financing (TIF) area pursuant to R.C. Section 5709.40(B) in the vicinity of the Milo-Grogan neighborhood (the “Milo-Grogan TIF”). The non-school portion of those service payments in lieu of taxes (the “Service Payments”) paid to the City for deposit into the Milo-Grogan TIF Fund will be used to finance public infrastructure improvements benefiting the Milo-Grogan TIF parcels in anticipation of new developments around the neighborhood.

Half Baked Holdings, LLC (the “Developer”) is redeveloping the former Kroger Bakery site on Cleveland Avenue (the “Site”) directly south of the Milo-Grogan TIF into a mixed-use development consisting of approximately 40,300 square feet of office, 9,600 square feet of retail, 363 multi-family units, 401 garage parking spaces, and an urban green space (collectively, the “Project”). Pursuant to Ordinance No. 0508-2021 passed on March 8, 2021 by City Council, the City entered the southern manufacturing building on the Site, which is also the former Ford Motor Company Branch Assembly Plant, on the Columbus Register of Historic Properties.

To further support the preservation of the now vacant, historical Site, and repurposing it for the Project, the City is submitting an ordinance for City Council consideration to amend the Original TIF Ordinance by adding the nonresidential improvements on the Site and other parcels surrounding the Milo-Grogan TIF to the same 100% exemption and 30-year term as the currently exempted parcels under the Original TIF Ordinance, and requiring that new Service Payments be deposited into the tax increment equivalent fund established for the Milo-Grogan TIF (the “Milo-Grogan TIF Fund”). This Ordinance will authorize the City to enter into a TIF Agreement with the Developer, and appropriate and authorize the expenditure of Service Payments deposited in the Milo-Grogan TIF Fund to reimburse the Developer for the costs of certain public infrastructure improvements, as defined in R.C. 5709.40(A)(8), pursuant to that TIF Agreement. This Ordinance will also authorize the appropriation and transfer of Service Payments from the Milo-Grogan TIF Fund to the Housing Business Tax Incentive Fund for the City’s retention of its economic development fees under the TIF Agreement as those fees are authorized by Ordinance No. 3169-2022.

Fiscal Impact: The City is appropriating and authorizing the expenditure of service payments in lieu of taxes deposited, and to be deposited, into the Milo-Grogan TIF Fund in accordance with a tax increment financing agreement between the City and Half Baked Holdings, LLC.

To authorize the appropriation and transfer of \$10,000.00 of service payments in lieu of taxes between the Milo-Grogan TIF Fund and the Housing Business Tax Incentive Fund; to authorize the appropriation and transfer of \$5,000.00 annually of service payments in lieu of taxes between the Milo-Grogan TIF Fund and the Housing Business Tax Incentive Fund during the term of the tax increment financing agreement; to appropriate and authorize the expenditure of service payments in lieu of taxes deposited, or to be deposited, into the Milo-Grogan TIF Fund to the developer or its designee; to authorize the Director of the Department of Development, on behalf of the City, to enter into a tax increment financing agreement between the City and Half Baked Holdings, LLC for reimbursement of certain public infrastructure improvements, as defined by R.C. 5709.40(A)(8). (\$10,000.00)

WHEREAS, pursuant to R.C. Section 5709.40(B) and Ordinance No. 3097-2015 (the “Original TIF

Ordinance”) passed December 14, 2015, City Council declared improvements to certain parcels of real property to be a public purpose, and established a non-school tax increment financing (TIF) including those certain parcels in the area generally bounded on all sides by the railroads surrounding the Milo-Grogan neighborhood (the “Milo-Grogan TIF”); and

WHEREAS, directly south of the Milo-Grogan TIF, Half Baked Holdings, LLC (the “Developer”) acquired approximately ±9.3 acres on which it is redeveloping the former Kroger Bakery site on Cleveland Avenue (the “Site”) into a mixed-use development consisting of approximately 40,300 square feet of office, 9,600 square feet of retail, 363 multi-family units, 401 garage parking spaces, and an urban green space (collectively, the “Project”); and

WHEREAS, Ordinance No. 0508-2021, passed on March 8, 2021 by City Council, authorized the City to enter the southern manufacturing building on the Site, which is also the former Ford Motor Company Branch Assembly Plant, on the Columbus Register of Historic Properties; and

WHEREAS, to help preserve the historic Site and repurpose it for the Project, the City is submitting for City Council consideration an ordinance to expand the Milo-Grogan TIF area and declare nonresidential improvements to certain parcels of real property in the expanded area to be a public purpose, and to exempt from taxation one-hundred percent (100%) of the nonresidential improvements of the Project on the Site, and nonresidential improvements on other parcels surrounding the Milo-Grogan TIF, for the same thirty-year exemption term as the existing parcels of the Milo-Grogan TIF; and

WHEREAS, the non-school service payments in lieu of taxes from the additional parcels will be distributed to the City for deposit into the tax increment equivalent fund established for the Milo-Grogan TIF (the “Milo-Grogan TIF Fund”), along with the existing collection of non-school service payments in lieu of taxes in that fund, to be used for the costs of certain public infrastructure improvements benefiting the Site and the Project, as defined by R.C. 5709.40(A)(8); and

WHEREAS, it is now necessary to appropriate and authorize the expenditure or transfer of the non-school service payments in lieu of taxes deposited, and to be deposited, into the Milo-Grogan TIF Fund, as provided hereafter; and

WHEREAS, this legislation will authorize the City to enter into a TIF Agreement with the Developer to use the non-school service payments within the Milo-Grogan TIF Fund for the reimbursement of certain public infrastructure improvements, as defined by R.C. 5709.40(A)(8), thereby preserving the public health, peace, safety and welfare; **NOW, THEREFORE**,

BE IT ORDAINED BY THE COUNCIL OF THE CITY OF COLUMBUS:

SECTION 1. TIF Agreement. That in consideration of the above, and consistent with the authority identified in R.C. 5709.40(B), the Director of the Department of Development (the “Director”), or his or her designee, for and in the name of the City, is authorized to execute and enter into the tax increment financing agreement (the “TIF Agreement”) with the Developer presently on file with the Director, along with any changes or amendments thereto not inconsistent with this Ordinance and not substantially adverse to the City, and which shall be approved by the Director and the City Attorney, provided that the approval of such changes and amendments thereto, and the character of those changes and amendments as not being substantially adverse to the City, shall be evidenced conclusively by the execution and delivery hereof, and to pay for the costs of certain public infrastructure improvements as identified in the TIF Agreement.

SECTION 2. Subsequent Actions. That the Director or other appropriate officers of the City are authorized to execute such other agreements, modifications, and instruments, subject to approval by the City Attorney's Office, and to take all actions as may be necessary to implement this Ordinance and the transactions contemplated by the TIF Agreement.

SECTION 3. City TIF Closing Fee Appropriation. That from the unappropriated monies and from all monies estimated to come into said fund from any and all sources and unappropriated for any other purpose during the fiscal year ended December 31, 2023, the sum of \$10,000.00 is appropriated in Fund 7469 (Milo-Grogan TIF Fund), Dept-Div 4402 (Economic Development), Object Class 10 (Transfer Out Operating) per the account codes in the attachment to this ordinance.

SECTION 4. City TIF Closing Fee Transfer. That the transfer of \$10,000.00 or so much thereof as may be needed, is authorized from Fund 7469 (Milo-Grogan TIF Fund), Dept-Div 4402 (Economic Development) to Fund 2229 (Housing Business Tax Incentive Fund), Dept-Div 4402 (Economic Development) per the account codes in the attachment to this ordinance.

SECTION 5. City TIF Administrative Fee. That subject to the authorization of the Director, the City Auditor is authorized to appropriate and make annual transfers as funds are received in Fund 7469 to Fund 2229 for the City TIF Administrative Fee, as that term is further described in the TIF Agreement and is currently \$5,000.00 per each outstanding TIF included in the TIF Agreement pursuant to this Ordinance and Ordinance No. 3169-2022.

SECTION 6. Appropriation and Expenditure. That the service payments in lieu of taxes and property tax rollback payments deposited and to be deposited into the Milo-Grogan TIF Fund (Fund 7469) created by the Original TIF Ordinance shall be deemed appropriated for the purposes set forth in the TIF Agreement and authorized to be expended therefrom in accordance with the Original TIF Ordinance, this Ordinance and the TIF Agreement authorized herein. The City Auditor is authorized to make payments to the Developer, or its authorized designee, from the Milo-Grogan TIF Fund in accordance with the TIF Agreement upon order of the Director, or his or her designee, and that no order shall be drawn or money paid except by voucher, the form of which shall be approved by the City Auditor.

SECTION 7. Accounting Codes. Funds are deemed appropriated and expenditures and transfers are authorized to carry out the purposes of this ordinance. That the City Auditor is authorized to establish such accounting codes as necessary, to make any accounting changes to revise the funding source for all agreements, contracts, amendments, or modifications associated with this Ordinance and the transactions contemplated by the TIF Agreement.

SECTION 8. Unencumbered Balance. That the City Auditor is authorized to transfer the unencumbered balance in a project account or subfund to the unallocated balance account within the same fund upon receipt of certification by the Director of the Department administering said project that the project has been completed and the monies are no longer required for said project.

SECTION 9. Effective Date. That this Ordinance shall take effect and be in force from and after the earliest period allowed by law.

Legislation Number: 2097-2023

Drafting Date: 7/6/2023

Current Status: Passed

Version: 1

Matter Type: Ordinance

Background: This ordinance authorizes the Director of the Recreation and Parks Department to enter into contract with GTC for the HVAC Equipment Upgrades 2020-2022 Project. The contract amount is \$3,659,500.00, with a contingency of \$315,000.00, for a total of \$3,974,500.00. An additional \$2,000.00 is being authorized for interdepartmental inspections and fees for a total of \$3,976,500.00 being authorized by this ordinance.

The Columbus Recreation and Parks Department is responsible for the operation of 46 buildings which contain mechanical HVAC systems. These buildings include community centers, athletic complexes, golf course clubhouses, and cultural arts centers.

Many of these systems are failing and at the end of their useful life. This project will replace air handlers, boilers, condensers, furnace units, fans, ductwork, and associated systems that are identified as failure critical and in poor condition. The project will also add air conditioning units to Howard Community Center. A summary of the work needed and locations is as follows:

- Barack Community Center - Replace boxing room air handler and two condensing units.
- Beatty Community Center - Replace auditorium air handler and rooftop condensing unit.
- Blackburn Community Center - Replace two roof-mounted exhaust fans.
- Carriage Place Community Center - Replace five classroom HVAC units and condensing units.
- Cleo Dumaree Athletic Complex - Replace boiler plant.
- Dodge Community Center - Clean, insulate, and jacket ductwork.
- Feddersen Community Center - Replace boiler plant
- Holton Community Center - Replace two electric furnaces with gas furnace and new condensing units
- Howard Community Center - Replace five classroom HVAC units and condensing units, add air conditioning units to gym and auditorium
- Raymond Golf Course - Replace six furnaces and condensing units
- Schiller Community Center - Replace two roof-mounted exhaust fans

Vendor Bid/Proposal Submissions (ODI designation status):

Bids were advertised through Vendor Services, in accordance with City Code Section 329, on June 2, 2023 and received by the Recreation and Parks Department on June 28, 2023. Bids were received from the following companies:

GTC (MAJ): \$3,428,000.00

After reviewing the bids that were submitted, it was determined that GTC was the lowest and most responsive bidder. GTC and all proposed subcontractors have met code requirements with respect to prequalification, pursuant to relevant sections of Columbus City Code Chapter 329.

As part of their bid, GTC has proposed the following vendors to fulfill the Office of Diversity and Inclusion project goal:

Approved Components and Systems (MBE)

Principal Parties:

General Temperature Control, LLC DBA GTC
970 West Walnut Street
Canal Winchester, Ohio 43110
Bob Billings, (614) 837-3888
Contract Compliance Number: 004830
Contract Compliance Expiration Date: August 31, 2024

Benefits to the Public: This project will improve the quality of these systems and improve their reliability, benefitting visitors and staff who spend time in these facilities. The reduction in building energy use enabled by this project will have an environmental impact as well, helping the City meet its climate goals which will have an impact on current and future generations of residents.

Community Input/Issues: The community has expressed the desire for well-kept and user friendly facilities through public workshops, social media, and direct contact with City staff.

Area(s) Affected: Citywide (99)

Master Plan Relation: This project will support the Recreation and Parks Master Plan by helping to improve operations and services to the citizens of Columbus.

Fiscal Impact: \$3,976,500.00 is budgeted and available from within the Recreation and Parks Voted Bond Fund 7702 to meet the financial obligations of this contract.

To authorize the Director of the Department of Recreation and Parks to enter into contract with GTC for the HVAC Equipment Upgrades 2020-2022 Project; to authorize the transfer of \$3,976,500.00 within the Recreation and Parks Voted Bond Fund, to authorize the amendment of the 2023 Capital Improvements Budget; and to authorize the expenditure of \$3,976,500.00 from the Recreation and Parks Voted Bond Fund. (\$3,976,500.00)

WHEREAS, it is necessary to authorize the Director of the Recreation and Parks to enter into contract with GTC for the HVAC Equipment Upgrades 2020-2022 Project; and

WHEREAS, it is necessary to authorize the transfer of \$3,976,500.00 within the Recreation and Parks Voted Bond Fund 7702; and

WHEREAS, it is necessary to authorize the amendment of the 2023 Capital Improvements Budget Ordinance 1711-2023 in order to provide sufficient budget authority for this and future projects; and

WHEREAS, it is necessary to authorize the expenditure of \$3,976,500.00 from the Recreation and Parks Voted Bond Fund 7702; and

WHEREAS, it has become necessary in the usual daily operations of the Recreation and Parks Department in that it is necessary to authorize the Director to enter into contract with GTC for the HVAC Equipment Upgrades 2020-2022 Project; **NOW THEREFORE,**

BE IT ORDAINED BY THE COUNCIL OF THE CITY OF COLUMBUS:

SECTION 1. That the Director of Recreation and Parks be and is hereby authorized to enter into contract with

GTC for the HVAC Upgrades 2020-2022 Project.

SECTION 2. That the funds necessary to carry out the purpose of this ordinance are hereby deemed appropriated, and the City Auditor shall establish such accounting codes as necessary.

SECTION 3. That the City Auditor is authorized to make any accounting changes to revise the funding source for all contracts or contract modifications associated with this ordinance.

SECTION 4. That the City Auditor is hereby authorized to transfer the unencumbered balance in a project account to the unallocated balance account within the same fund upon receipt of certification by the Director of the Department administering said project that the project has been completed and the monies are no longer required for said project.

SECTION 5. That the transfer of \$3,976,500.00 or so much thereof as may be needed, is hereby authorized between projects within the Recreation and Parks Bond Fund 7702 per the account codes in the attachment to this ordinance.

SECTION 6. That the 2023 Capital Improvements Budget Ordinance 1711-2023 is hereby amended as follows in order to provide sufficient budget authority for this ordinance and future projects.

Fund / Project / Project Name / Current Revised Authority / Current Remaining Authority / Change / Amended Revised Authority / Amended Remaining Authority

Fund 7702 / P511035-100000 / Climate Action Plan (Voted Carryover) / \$5,353,800 / \$5,353,800 / (\$3,549,300) / \$1,804,500 / \$1,804,500

Fund 7702 / P514002-100000 / Program Projects (Small) Golf Misc. (Voted Carryover) / \$542,000 / \$542,000 / (\$427,200) / \$114,800 / \$114,800

Fund 7702 / P511040-202102; HVAC Upgrades 2020-2022 (Voted Carryover) / \$0 / \$0 / \$3,976,500 / \$3,976,500 / \$3,976,500

SECTION 7. For the purpose stated in Section 1, the expenditure of \$3,976,500.00 or so much thereof as may be necessary to pay the cost thereof, be and is hereby authorized from the and Parks Voted Bond Fund 7702 in object class 06 Capital Outlay per the accounting codes in the attachments to this ordinance.

SECTION 8. That this ordinance shall take effect and be in force from and after the earliest period allowed by law.

Legislation Number: 2098-2023

Drafting Date: 7/6/2023

Current Status: Passed

Version: 1

Matter Type: Ordinance

Background: This ordinance authorizes the Director of the Recreation and Parks Department modify an existing contract with Pavement Protectors, Inc. DBA M&D Blacktop for the Hard Surface Improvements 2021-2022 Project. The modification amount being authorized by this ordinance is \$135,000.00. The original contract was authorized by Ordinance 2031-2022.

Each year, the Recreation and Parks Department allocates a portion of the Capital Improvement Budget for the

improvement of existing hard surfaces and new installations of hard surfaces. This particular contract focuses on the improvement of asphalt and concrete surfaces that are highly used by the public and includes entry drives, parking lots, trails, sidewalks, and sport courts. By improving these surfaces, safe and easy access can be ensured to the parks and facilities. Areas for improvement were initially considered through recommendations from internal staff and public involvement. All requests were assessed through a Pavement Condition Rating (PCR) form and were given a rating from 0, meaning the worst condition, to 100, meaning the best condition. All requests were prioritized for action based on their respective PCR scores. From there, staff confirmed which projects to move forward with.

The additional scope of work outlined below was not included in the original contract because they were not known or prioritized at that time. Since the contract was awarded, the additional scope of work was elevated in importance and urgency due to 311 requests and safety concerns. The current contract will perform the work as efficiently and cost effectively as possible. Work was negotiated using established unit prices. It is not advantageous to pursue another procurement process due to the emergency need for this work to be completed and the prices came from the established low bidder.

The additional scope of work is as follows:

Driving Park - tennis courts improvements
Thompson Park - basketball courts Improvements
Deshler Park - concrete drive apron improvements Tuttle Park - Restripe speed hump
Marie Mooreland Playground - pave ADA compliant hard surface connector

Principal Parties:

Pavement Protectors, Inc. DBA M&D Blacktop
2020 Longwood Avenue
Grove City, Ohio, 43123
Mark Nance, (614) 875-9989
Contract Compliance Number: 004731
Contract Compliance Expiration Date: January 26, 2025

Emergency Justification: Emergency action is requested due to public safety concerns at these locations as cracked pavement on sport courts can lead to injury and this existing contract needs to be modified in order to avoid a delay in completion of the work as there is a limited window for weather appropriate construction of hard surface improvements prior to the end of 2023.

Benefits to the Public: This project aims to provide accessible and usable asphalt, concrete, and sport court improvements throughout our park properties.

Community Input/Issues: Needed improvements were identified by both internal staff and from community requests. The community has expressed the desire for well-kept facilities and amenities through public workshops, social media, and direct contact with staff.

Area(s) Affected: Citywide (99)

Master Plan Relation: This project will support the Recreation and Parks Master Plan by removing access and circulation barriers to city parks. It also helps meet the goal of improving at least five neighborhood parks per year.

Fiscal Impact: The expenditure of \$1,127,000.00 was legislated for the Hard Surface Improvements 2021-2022 Project by Ordinance 2031-2022. This ordinance will provide funding that will modify the previously authorized amount by \$135,000.00. \$135,000.00 is budgeted and available in the Recreation and Parks Voted Bond Fund 7702 to meet the financial obligations of this contract modification. The aggregate total amount authorized, including this modification, is \$1,262,000.00.

To authorize the Director of Recreation and Parks to modify an existing contract with Pavement Protectors, Inc. DBA M&D Blacktop for the Hard Surface Improvements 2021-2022 Project; to authorize the transfer of \$135,000.00 within the Recreation and Parks Voted Bond Fund, to authorize the amendment of the 2023 Capital Improvements Budget; to authorize the expenditure of \$135,000.00 from the Recreation and Parks Voted Bond Fund; and to declare an emergency. (\$135,000.00)

WHEREAS, it is necessary to authorize the Director of the Recreation and Parks to modify an existing contract with Pavement Protectors, Inc. DBA M&D Blacktop for the Hard Surface Improvements 2021-2022 Project; and

WHEREAS, it is necessary to authorize the transfer of \$135,000.00 within the Recreation and Parks Voted Bond Fund 7702; and

WHEREAS, it is necessary to authorize the amendment of the 2023 Capital Improvements Budget Ordinance 1711-2023 in order to provide sufficient budget authority for this and future projects; and

WHEREAS, it is necessary to authorize the expenditure of \$135,000.00 from the Recreation and Parks Voted Bond Fund 7702; and

WHEREAS, an emergency exists in the usual daily operations of the Recreation and Parks Department in that it is immediately necessary to authorize the Director to modify the contract with Pavement Protectors DBA M&D Blacktop due to public safety concerns at these locations as cracked pavement on sports courts can lead to injury and this existing contract needs to be modified in order to avoid a delay in completion of the work as there is a limited window for weather appropriate construction of hard surface improvements prior to the end of 2023, all for the preservation of the public health, peace, property, safety, and welfare and, **NOW, THEREFORE**

BE IT ORDAINED BY THE COUNCIL OF THE CITY OF COLUMBUS:

SECTION 1. That the Director of Recreation and Parks be and is hereby authorized to modify an existing contract with Pavement Protectors, Inc. DBA M&D Blacktop for the Hard Surface Improvements 2021-2022 Project. The modification amount being authorized by this ordinance is \$135,000.00.

SECTION 2. That the funds necessary to carry out the purpose of this ordinance are hereby deemed appropriated, and the City Auditor shall establish such accounting codes as necessary.

SECTION 3. That the City Auditor is authorized to make any accounting changes to revise the funding source for all contracts or contract modifications associated with this ordinance.

SECTION 4. That the City Auditor is hereby authorized to transfer the unencumbered balance in a project account to the unallocated balance account within the same fund upon receipt of certification by the Director of the Department administering said project that the project has been completed and the monies are no longer required for said project.

SECTION 5. That the transfer of \$135,000.00 or so much thereof as may be needed, is hereby authorized between projects within the Recreation and Parks Bond Fund 7702 per the account codes in the attachment to this ordinance.

SECTION 6. That the 2023 Capital Improvements Budget Ordinance 1711-2023 is hereby amended as follows in order to provide sufficient budget authority for this ordinance and future projects.

Fund / Project / Project Name / Current Revised Authority / Current Remaining Authority / Change / Amended Revised Authority / Amended Remaining Authority

Fund 7702 / P511000-100000 / Renovation - Misc. (Voted Carryover) / \$5,276,964 / \$5,276,964 / (\$524,101) / \$4,752,863 / \$4,752,863 (to match cash)

Fund 7702 / P511000-100000 / Renovation - Misc. (Voted Carryover) / \$4,752,863 / \$4,752,863 / (\$135,000) / \$4,617,863 / \$4,617,863

Fund 7702 / P511007-202103 / Hard Surface Improvements 2021-2022 (Voted Carryover) / \$0 / \$0 / \$135,000 / \$135,000 / \$135,000

SECTION 7. For the purpose stated in Section 1, the expenditure of \$135,000.00 or so much thereof as may be necessary to pay the cost thereof, be and is hereby authorized from the Recreation and Parks Voted Bond Fund 7702 in object class 06 Capital Outlay per the accounting codes in the attachments to this ordinance.

SECTION 8. That for the reasons stated in the preamble hereto, which is hereby made a part hereof,, this ordinance is hereby declared to be an emergency measure and shall take effect and be in force from and after its passage and approval by the Mayor, or ten days after passage if the Mayor neither approves nor vetoes the same.

Legislation Number: 2102-2023

Drafting Date: 7/6/2023

Current Status: Passed

Version: 1

Matter Type: Ordinance

Background: This ordinance authorizes the Director of Recreation and Parks to execute and acknowledge any documents or agreements, as approved by the City Attorney, to amend, release, modify, or enter into new Environmental Covenants involving City owned real property located near Rocky Fork Creek, and to grant a sewer easement to the City of New Albany for a new public park (Taylor Farm).

The City of Columbus is the owner of a 42 acre protected natural area in the City's northeast area. The property is generally located east of Hamilton Road and south of State Route 161, with the Rocky Fork Creek flowing along the eastern boundary. The property is subject to an Ohio EPA Environmental Covenant (EC), recorded as Instrument Number 200710120179039. Immediately east of the Property, the City of New Albany is building a new 98 acre public park and wetland restoration area, as well as a section of the Rocky Fork regional greenway. New Albany has approached the Columbus Recreation and Parks Department to request the granting of a sanitary sewer easement that is approximately 25 feet by 50 feet along the south Property line of the EC, along Old Dublin-Granville Road, to service a new visitor center at the park. The Columbus Recreation and Parks Department has reviewed the request and examined its location. The Department agrees that granting the easement creates minimal environmental impact to the property during construction and

creates no long term impacts. The Ohio EPA has agreed to amend the EC to allow for the sanitary sewer to connect to a manhole on the Property. The Columbus Recreation and Parks Department supports amending the EC and granting the sanitary easement to another governmental agency at no cost, given that it will allow the public park to be developed.

Principal Parties:

City of New Albany
99 West Main Street
New Albany, Ohio 43054
Adrienne Joly, (614) 855-3913, ajoly@newalbanyohio.org

Emergency Justification: Emergency action is requested as there is urgency to allow for the easement to be granted for the new park to finish construction in 2023, prior to inclement weather.

Benefits to the Public: The far northeast area of Columbus, in the Hamilton Road Corridor, is one of the City’s fastest developing areas, and City of Columbus property surrounds this new park on three sides. Having a new 98 acre park, natural area, and trail developed in this underserved area provides significant benefits for over 3,000 Columbus residents within a 10 minute walk to the site. New Albany and Columbus have been partnering for several years on development of greenspaces and trail connectivity along their 3 mile shared Rocky Fork Creek boundary. This project will become an anchor park and trail head for the community.

Community Input/Issues: Significant public input was involved in the development planning for the site, including trail accessibility, visitor amenities, wetland restoration, and educational interpretive facilities.

Area(s) Affected: Rocky Fork-Blacklick (33)

Master Plan Relation: This project will support the Recreation and Parks Master Plan by providing high quality, accessible parks within a 10 minute walkshed of all Columbus residents.

Fiscal Impact: No fiscal action is required at this time.

To authorize the Director of the Recreation and Parks Department to execute and acknowledge any documents or agreements, as approved by the City Attorney, to amend, release, modify, or enter into new Environmental Covenants involving City owned real property located near Rocky Fork Creek; to grant a sewer easement to the City of New Albany for a new public park (Taylor Farm); and to declare an emergency. (\$0)

WHEREAS, it is necessary to authorize the Director of the Recreation and Parks Department to execute and acknowledge any documents or agreements, as approved by the City Attorney, to amend, release, modify, or enter into new Environmental Covenants involving City owned real property located near Rocky Fork Creek; and to grant a sewer easement to the City of New Albany for a new public park (Taylor Farm); and

WHEREAS, an emergency exists in the usual daily operations of the Recreation and Parks Department in that it is immediately necessary to authorize the Director to execute and acknowledge any documents or agreements, as approved by the City Attorney, to amend, release, modify, or enter into new Environmental Covenants involving City owned real property located near Rocky Fork Creek, and to grant a sewer easement to the City of New Albany for a new public park as there is urgency to allow for the easement to be granted for the new park to finish construction in 2023, prior to inclement weather, all for the preservation of the public health, peace, property, safety, and welfare and, **NOW, THEREFORE,**

BE IT ORDAINED BY THE COUNCIL OF THE CITY OF COLUMBUS:

SECTION 1. That the Director of Recreation and Parks is hereby authorized to execute and acknowledge any documents or agreements, as approved by the City Attorney, to amend, release, modify, or enter into new Environmental Covenants involving City owned real property located near Rocky Fork Creek; and to grant a sewer easement to the City of New Albany for a new public park (Taylor Farm).

SECTION 2. That for the reasons stated in the preamble hereto, which is hereby made a part hereof, this ordinance is hereby declared to be an emergency measure and shall take effect and be in force from and after its passage and approval by the Mayor, or ten days after passage if the Mayor neither approves nor vetoes the same.

Legislation Number: 2105-2023

Drafting Date: 7/6/2023

Current Status: Passed

Version: 1

Matter Type: Ordinance

1. BACKGROUND: This ordinance authorizes the Director of Public Utilities to enter into a planned contract modification for general engineering services with T&M Associates for the DPU General Engineering Consultant Services (GEC) #5, CIP #650260-100400, in an amount up to \$500,000.00.

General Engineering Consultant (GEC) Services are necessary to provide technical and engineering assistance to the Department of Public Utilities (DPU). Initial services are for Division of Sewerage and Drainage (DOSD) facilities. Additional DPU facilities may be added in the future. The GEC services may include the following tasks for small projects: investigations, inspections and evaluations of existing conditions, surveying, preparation of engineering or architectural drawings and specifications, review of contractors' submittals including shop drawings, maintenance and operation (M&O) manuals, Standard Operating Procedures (SOPs). The GEC services may also include assistance with new equipment or systems start-up and commissioning, instrumentation & control (I&C) work such as Human Machine Interface (HMI) and Programmable Logic Controller (PLC) programming, uploading documents onto the City's Project Management Information System (PMIS), computerized maintenance software, preparation of record plan drawings for small projects, technical assistance in the preparation of Facilities/Equipment Maintenance (FEM) documents, and other similar related tasks. Small projects that may, on occasion, require engineering services under this contract include small Capital Improvement Projects (formerly known as "Plant Improvement Projects" or "PIPs") and FEM service contracts.

The small Capital Improvement Projects (CIP) will vary in nature and can include replacement and upgrade of equipment, materials, structural features, electrical, or instrumentation & control (I&C) work and their associated appurtenances that have served its useful life.

The actual construction and commissioning of upgrades in the several facilities will generally be accomplished by others.

Planning Area: 99 - Citywide

1.1 Amount of additional funds to be expended: \$500,000.00

Original Contract Amount:	\$500,000.00	(Ord. 2939-2021 PO308113)
Modification #1 Amount:	\$500,000.00	(Current)
<u>Modification #2 Amount:</u>	<u>\$500,000.00</u>	<u>(Future)</u>
Total (Orig. + Modification):	\$1,500,000.00	

1.2. Reason other procurement processes are not used:

This contract was put in place as a three-year contract. This is the first of two planned modifications to add funding to the contract.

1.3. How cost of modification was determined:

The cost of the modification was determined based upon rates and allowable expenses already established in the contract.

2. ECONOMIC IMPACT/ADVANTAGES; COMMUNITY OUTREACH; PROJECT DEVELOPMENT; ENVIRONMENTAL FACTORS/ADVANTAGES OF PROJECT:

The performance of this project’s activities to provide engineering and technical services for CIPs and FEMs at DPU facilities will help them maintain peak operational performance. If left unperformed, the required work could become larger and more expensive that could produce a major impact to the budget. No community outreach is considered for this project.

3. CONTRACT COMPLIANCE INFO:

T&M Associates’ contract compliance number is CC001614 and expires 5/24/24.

Searches in the Excluded Party List System (Federal) and the Findings for Recovery list (State) produced no findings against T&M Associates

4. MINORITY AND WOMAN OWNED BUSINESS ENTERPRISE & SMALL LOCAL BUSINESS ENTERPRISE PROGRAM

This contract was put in place prior to the implementation of the City of Columbus MBE/WBE Program and is not subject to the requirements of that program. T&M Associates is classified as a majority company by the City’s Office of Diversity and Inclusion. T&M Associates anticipates performing the work on this contract modification with the use of sub-consultants, one of which is an MBE and one is a WBE. The MBE/WBE percentage cannot be determined until tasks are assigned to the contract.

As part of their proposal, T&M Associates has proposed the following three subcontractors to perform contract work:

<u>Company Name</u>	<u>City/State</u>	<u>ODI Certification Status</u>
Brown and Caldwell MAJ		Columbus, Ohio
Andover Associates, Ltd. WBE		Columbus, Ohio
Dynotec MBE		Columbus, Ohio

The certification of T&M Associates and the above companies was in good standing at the time the bid was awarded.

5. FISCAL IMPACT

Funds are available and appropriated within the Sanitary Bond Fund, Fund 6109. An amendment to the 2023 Capital Improvement Budget is needed to align budget authority with the proper project. Amendments to the 2023 Capital Improvement Budget are contingent upon approval of the 2023 Capital Improvement Budget.

To authorize the Director of the Department of Public Utilities to modify and increase the contract with T&M Associates for the DPU General Engineering Consultant Services #5 Project; to authorize an amendment to the

2023 Capital Improvement Budget; and to authorize an expenditure of up to \$500,000.00 within the Sanitary Bond Fund to pay for the contract modification. (\$500,000.00)

WHEREAS, the Department of Public Utilities is engaged in the DPU General Engineering Consultant Services (GEC) #5 Project; and

WHEREAS, Contract No. PO308113 was authorized by Ordinance No. 2939-2021, for the DPU General Engineering Consultant Services (GEC) #5 Project; and

WHEREAS, a planned contract modification is needed for engineering services; and

WHEREAS, it is necessary for Council to authorize the Director of Public Utilities to modify the professional engineering services agreement with T&M Associates for the DPU General Engineering Consultant Services (GEC) #5 Project; and

WHEREAS, an amendment to the 2023 Capital Improvement Budget is needed to align budget authority with the proper project; and

WHEREAS, it is necessary to expend funds from the Sanitary Bond Fund to pay for the contract renewal;
NOW, THEREFORE,

BE IT ORDAINED BY THE COUNCIL OF THE CITY OF COLUMBUS:

SECTION 1. That the 2023 Capital Improvement Budget authorized by Ordinance 1711-2022 be amended as follows to establish sufficient budget authority for this project:

Fund / Project Number / Project Name / Current / Change / Amended

6109 / 650260-102016 / JPWWTP Incinerator Building Rehabilitation (Voted Sanitary Carryover) / \$853,867.00 / \$353,867.00 / (\$500,000.00)

6109 / 650260-100400 / DPU General Engineering Consultant Services (GEC) #5 (Voted Sanitary Carryover) / \$0.00 / \$500,000.00 / \$500,000.00

SECTION 2. That the Director of Public Utilities is hereby authorized to modify and increase the general engineering services contract with T&M Associates, 4675 Lakehurst Ct Suite 250, Dublin, Ohio 43016; for the DPU General Engineering Consultant Services (GEC) #5 project, in an amount up to \$500,000.00.

SECTION 3. That an expenditure of \$500,000.00, or so much thereof as may be needed, is hereby authorized from the Sanitary Bond Fund, Fund 6109, to pay for this contract modification per the accounting codes in the attachment to this ordinance.

SECTION 4. Funds are hereby deemed appropriated and expenditures authorized to carry out the purposes of this ordinance and the City Auditor shall establish such accounting codes as necessary.

SECTION 5. That the City Auditor is authorized to make any accounting changes to revise the funding source for all contracts or contract modifications associated with this ordinance.

SECTION 6. That the City Auditor is hereby authorized to transfer the unencumbered balance in a project account to the unallocated balance account within the same fund upon receipt of certification by the Director

of the Department administering said project that the project has been completed and the monies are no longer required for said project.

SECTION 7. That this Ordinance shall take effect and be in force from and after the earliest period allowed by law.

Legislation Number: 2108-2023

Drafting Date: 7/6/2023

Current Status: Passed

Version: 1

Matter Type: Ordinance

This legislation will ensure that no operator of rental housing shall refuse to accept tender on behalf of a tenant on the basis that the tender was proffered by a person other than the tenant.

To amend Chapters 4501 and 4551 of the Columbus City Codes to ensure that no operator shall refuse to accept tender on behalf of a tenant on the basis that the tender was proffered by a person other than the tenant.

WHEREAS, it is in the best interest of all parties to a rental agreement that operators accept tender on behalf of a tenant so the landlord will not be forced to begin a costly eviction proceeding; and

WHEREAS, current code does not require this; and

WHEREAS, there are currently millions of dollars in rental and utility assistance funds available for qualifying residential occupants and owners who have experienced financial hardship; and

WHEREAS, amending the city code to require operators to accept tender on behalf of a tenant and remain housed would benefit the City of Columbus by allowing the occupant(s) to remain in safe and sanitary housing; **NOW, THEREFORE**,

BE IT ORDAINED BY THE COUNCIL OF THE CITY OF COLUMBUS:

SECTION 1. That Chapter 4501 of the Columbus City Codes is hereby amended to enact new section 4501.406 to read as follows:

4501.406 - Tender

Tender means the payment of rent. Tender may be made in any lawful form authorized pursuant to a written rental agreement, provided for by city code or state law, or approved by a court of competent jurisdiction.

SECTION 2. That Chapter 4551 of the Columbus City Codes is hereby amended to enact new section 4551.06 to read as follows:

4551.06 - Third Party Tender

(a) Except as otherwise provided in division (b), no operator shall refuse to accept tender on behalf of a tenant on the basis that the tender was proffered by a person other than the tenant.

(b) Nothing in this section shall be construed as requiring an operator to accept tender on behalf of a tenant that is in breach or default of a written rental agreement or a tenant holding premises under an oral tenancy that is in default on the payment of rent.

(c) An operator who violates division (a) is guilty of failure to accept tender, a misdemeanor of the fourth degree.

(d) Organizational criminal liability as provided for in Section 2301.23 is contemplated where an organization is an operator.

(e) If an operator refuses to accept third party tender on behalf of a tenant who is not in breach or default of a

written rental agreement or a tenant holding premises under an oral tenancy that is not in default on the payment of rent as required by this section, the attempted tender by the third party shall be an affirmative defense in any eviction action filed against the tenant for non-payment of rent.

SECTION 2. That this ordinance shall take effect and be in force from and after the earliest period allowed by law.

Legislation Number: 2109-2023

Drafting Date: 7/6/2023

Current Status: Passed

Version: 2

Matter Type: Ordinance

Ohio is one of only five states that allows landlords to evict if a tenant pays rent just one day late or a dollar short. Given the many negative consequences to evicted tenants and the impact on public services, this ordinance would give tenants a reasonable chance to pay back their rent and remain in their homes. This legislation would standardize an existing defense to eviction action by allowing tenants to pay everything that is owed to avoid eviction. The landlord is made whole for all lost rent and expenses.

To amend Chapter 4551 of the Columbus City Codes to ensure that occupants in residential rental properties are afforded the right to assert tender of rent as an affirmative defense to an eviction action filed on the basis of nonpayment of rent.

WHEREAS, it is in the best interest of all parties to an eviction action that occupants are afforded the right to assert payment of rent as an affirmative defense to an eviction action filed on the basis of nonpayment of rent; and

WHEREAS, current code does not require an operator to enter into pay to stay agreements; and

WHEREAS, there are currently millions of dollars in rental and utility assistance funds available for qualifying residential occupants and owners who have experienced financial hardship; and

WHEREAS, amending the city code to allow occupants the right to assert payment and remain housed would benefit the City of Columbus by allowing the occupant(s) to remain in safe and sanitary housing; **NOW**,

THEREFORE,

BE IT ORDAINED BY THE COUNCIL OF THE CITY OF COLUMBUS:

SECTION 1. That Chapter 4551 of The Columbus City Codes is hereby amended to read as follows:

4551.07 Tenant’s Right to Assert Tender of Rent as an Affirmative Defense to Eviction

(a) Tenant’s Affirmative Defense after Tendering Rent Prior to the Filing of an Eviction Action

(1) If a tenant, or an agency or individual on the tenant’s behalf, tenders all past due rent with reasonable late fees to the landlord prior to the filing of an action under Ohio Revised Code Chapter 1923 and the landlord refuses to accept the payment tendered, the tenant’s tender of all past due rent with reasonable late fees shall be an affirmative defense to any action filed by the landlord against the tenant for nonpayment of rent.

~~(2) If a rental agreement includes a provision that authorizes the landlord to assess the tenant a fee for late payment of the monthly rent, the total amount of that late payment fee from any month may not exceed the larger of: (A) fifty dollars (\$50.00); or (B) ten percent (10%) of the monthly contract rent.~~

(b) Tenant’s Affirmative Defense after Tendering Rent Prior to an Eviction Judgement

(1) If a tenant, or an agency or individual on the tenant’s behalf, tenders all past due rent with reasonable late fees and court costs to the landlord prior to a judgment and the landlord refuses to accept the payment tendered, the tenant’s tender of all past due rent, reasonable late fees, and court

costs shall be an affirmative defense to the eviction action filed by the landlord against the tenant for nonpayment of rent.

~~(2) If a rental agreement includes a provision that authorizes the landlord to assess the tenant a fee for late payment of the monthly rent, the total amount of that late payment fee from any month may not exceed the larger of: (A) fifty dollars (\$50.00); or (B) ten percent (10%) of the monthly contract rent.~~

(c) Effect upon other claims for eviction. A tenant's tender of payment pursuant to this section does not limit the ability of a landlord to initiate an eviction action for reasons other than solely for non-payment of rent.

SECTION 2. That this ordinance shall take effect and be in force from and after the earliest period allowed by law.

Legislation Number: 2118-2023

Drafting Date: 7/6/2023

Current Status: Passed

Version: 1

Matter Type: Ordinance

1. Background:

The City of Columbus, Department of Public Service, received a request from Molly C. Mount asking that the City transfer a 2,396 square foot (0.055 acre) portion of the un-named alley that is adjacent to her property at 1954 Kenton Avenue to her. The right-of-way area is an unnamed alley running east / west directionally. It is the first alley north of Kenton Avenue and the first alley south of Payne Avenue. Parcel 010-122577 is on the north side of the requested portion; Parcel 010-122532 is on the south side of the requested portion.

Transfer of this right-of-way is to support her building supply business by connecting her current parcels to allow for better flow of vehicles loading and unloading supplies and material. The Department of Public Service has agreed to transfer the right-of-way as described and shown within attached legal description and exhibit, and extinguishes its need for this public right-of-way.

Per current practice, comments were solicited from interested parties, including City agencies, private utilities and the applicable area commission, before it was determined that, subject to the retention of a general utility easement for those utilities currently located within this right-of-way, the City will not be adversely affected by the transfer of this right-of-way.

The Department of Public Service submitted a request to the City Attorney's Office, asking that they establish a value for this right-of-way, and a value of \$23,950.00 was established.

This request went before the Land Review Commission on March 16, 2023. After review of the request, the Land Review Commission voted to recommend the above referenced right-of-way be transferred to Molly C. Mount at the cost of \$23,950.00 to her.

2. FISCAL IMPACT:

The City will receive a total of \$23,950.00 and the funds are to be deposited in Fund 7748, Project P537650, as consideration for the transfer of the requested right-of-way.

To authorize the Director of the Department of Public Service to execute those documents necessary for the transfer of a 0.055 acre portion of the un-named alley that is adjacent to 1954 Kenton Avenue to Molly C.

Mount. (\$23,950.00)

WHEREAS, the City of Columbus, Department of Public Service, received a request from Molly C. Mount asking that the City transfer a 2,396 square foot (0.055 acre) portion of the un-named alley that is adjacent to her property at 1954 Kenton Avenue to her. The right-of-way area is an unnamed alley running east / west directionally. It is the first alley north of Kenton Avenue and the first alley south of Payne Avenue. Parcel 010-122577 is on the north side of the requested portion; Parcel 010-122532 is on the south side of the requested portion; and

WHEREAS, transfer of this right-of-way is to support her building supply business by connecting her current parcels to allow for better flow of vehicles loading and unloading supplies and material; and

WHEREAS, the Department of Public Service has agreed to transfer the right-of-way as described and shown within attached legal description and exhibit, and extinguishes its need for this public right-of-way; and

WHEREAS, per current practice, comments were solicited from interested parties, including City agencies, private utilities and the applicable area commission, before it was determined that, subject to the retention of a general utility easement for those utilities currently located within this right-of-way, the City will not be adversely affected by the transfer of this right-of-way; and

WHEREAS, the Department of Public Service submitted a request to the City Attorney's Office, asking that they establish a value for this right-of-way; and

WHEREAS, a value of \$23,950.00 was established; and

WHEREAS, this request went before the Land Review Commission on March 16, 2023; and

WHEREAS, after review of the request, the Land Review Commission voted to recommend the above referenced right-of-way be transferred to Molly C. Mount at the cost of \$23,950.00; **now, therefore**

BE IT ORDAINED BY THE COUNCIL OF THE CITY OF COLUMBUS:

Section 1. That the Director of the Department of Public Service be and is hereby authorized to execute a quit claim deed and other incidental instruments prepared by the City Attorney's Office, necessary to transfer the legal description as described below and attached exhibit of right-of-way to Molly C. Mount.

Section 2. That the attached referenced real property shall be considered excess road right-of-way and the public rights therein shall terminate upon the Director's execution and delivery of said quitclaim deed to the grantee thereof.

Section 3. That a general utility easement in, on, over, across and through the attached legal description and exhibit describing the right-of-way shall be and hereby is retained unto the City of Columbus for those utilities located within said right-of-way.

Section 4. That upon notification and verification of the relocation of all utilities located within the retained general utility easement area the Director of the Department of Public Service is hereby authorized to execute those documents necessary to release the retained general utility easement with no additional compensation due to the City and with no further legislative action required by the City.

Section 5. That the City will receive a total of \$23,950.00, to be deposited in Fund 7748, Project P537650.

Section 6. That this ordinance shall take effect and be in force from and after the earliest period allowed by law.

Legislation Number: 2119-2023

Drafting Date: 7/6/2023

Current Status: Passed

Version: 1

Matter Type: Ordinance

BACKGROUND

This legislation authorizes the Finance and Management Director to establish a purchase order for the Department of Building and Zoning Services to purchase 6 small Ford SUV vehicles from George Byers Sons Inc. Vehicles will be purchased through the city-wide universal term contract approved by Purchasing.

<u>Item</u>	<u>Quantity</u>	<u>Total Cost</u>
Ford Edge	6	\$209,952.00

George Byers Sons Inc, Vendor # 006008, PA004790 (Exp. 6/30/24) - Light Duty Trucks

EMERGENCY JUSTIFICATION

Emergency action is requested in order to avoid delay and disruption in the usual daily operations of Building and Zoning Services so that the vehicles can be purchased in a timely manner to avoid delay caused by the instability of the automobile supply chain, resultant market volatility of all the OEMs that continues with the ongoing shortage of chips and other critical supply line parts to produce vehicles, resulting in limited availability causing vehicle order windows to open and close, at random, with little to no notice, in order to timely purchase the vehicles.

FISCAL IMPACT

Funding for this purchase is budgeted and available within the Development Services Fund.

To authorize the Director of Finance and Management to establish a purchase order for the purchase of vehicles for the Department of Building and Zoning Services; to authorize an expenditure from the Development Services Fund; and to declare an emergency. (\$209,952.00)

WHEREAS, the Purchasing Office has established contracts for the purchase of vehicles; and

WHEREAS, the Department of Building and Zoning Services is in need of vehicles to replace older vehicles; and

WHEREAS, it is necessary to establish funding per the terms and conditions of an existing universal term contract; and

WHEREAS, funding is available for these purchases within the Development Services Fund; and

WHEREAS, an emergency exists in the usual daily operation of the Department of Building and Zoning Services in that it is necessary to authorize the Finance and Management Director to establish a purchase order to purchase 6 small Ford SUV vehicles from George Byers Sons Inc. in order to avoid delay caused by the instability of the automobile supply chain, resultant market volatility of all the OEMs that continues with the ongoing shortage of chips and other critical supply line parts to produce vehicles, resulting in limited availability causing vehicle order windows to open and close, at random, with little to no notice, in order to timely purchase the vehicles to avoid delay and disruption in the usual daily operations of Building and Zoning Services, all for the immediate preservation of the public health, peace, property, safety, and welfare; **now, therefore,**

BE IT ORDAINED BY THE COUNCIL OF THE CITY OF COLUMBUS:

SECTION 1. That the Director of Finance and Management be and hereby is authorized to establish a purchase order with George Byers Sons Inc per the terms and conditions of an existing Universal Term Contract, for the purchase of vehicles on behalf of the Department of Building and Zoning Services.

SECTION 2. That the funds necessary to carry out the purpose of this ordinance are hereby deemed appropriated, and the City Auditor shall establish such accounting codes as necessary.

SECTION 3. That the expenditure of \$209,952.00, or so much thereof as may be necessary, be and is hereby authorized in Fund 2240 Development Services Fund in object class 06 Capital Outlay per the accounting codes in the attachment to this ordinance.

See Attached File: Ord. 2119-2023 Legislation Template

SECTION 4. That the City Auditor is authorized to make any accounting changes to revise the funding source for all contracts or contract modifications associated with this ordinance.

SECTION 5. That for the reasons stated in the preamble thereto, which is hereby made a part hereof, this ordinance is declared to be an emergency measure and shall take effect and be in force from and after its passage and approval by the Mayor, or ten days after passage if the Mayor neither approves nor vetoes the same.

Legislation Number: 2121-2023

Drafting Date: 7/6/2023

Current Status: Passed

Version: 1

Matter Type: Ordinance

Background: This ordinance authorizes the Finance and Management Director to establish purchase orders with The Dexter Company in the amount of \$73,138.36 and Kueper North America in the amount of \$7,440.00 for the purchase of aftermarket snow plow parts per the results of bid solicitation RFQ025121. These Snow Plow Parts are needed for use by the Department of Public Service for maintenance and upkeep of its snow removal vehicles. This bid was processed in accordance with the competitive bidding provisions of Columbus City Code. Five bids were received and opened for RFQ025121 on 06/29/2023 from the following respondents:

HYO, Inc.
Dexter Company
Kueper North America

ACE Truck Body
Technology International Inc

It is requested that The Dexter Company be awarded line items 1-18 as the lowest and best bidder based on lowest price total overall and lowest lead time on production. It is also requested that Kueper North America be awarded line 19 as the sole bidder for that specific piece.

The Dexter Company Vendor #006581 expiration date 9/30/2023

Kueper North America Vendor #018468 expiration date pending

Fiscal Impact: This ordinance authorizes an expenditure of \$80,578.36 from the Fleet Management Operating Fund with The Dexter Company and Kueper North America collectively for the purchase aftermarket snow plow Parts. In 2022, the Fleet Management Division expended \$20,960.40 for aftermarket snow plow parts and in 2021 \$134,836.16 was expended for aftermarket snow plow parts.

Emergency action is requested to ensure that a purchase order can be established as quickly as possible. Worldwide spikes in the cost of steel have greatly increased lead times on many items, including these parts. In order to ensure these parts will be on hand in time for their seasonal need, emergency action is requested.

To authorize the Finance and Management Director, on behalf of the Fleet Management Division, to establish purchase orders with The Dexter Company (\$73,138.36) and Kueper North America (\$7,440.00) for the purchase of After Market Snow Plow Parts; to authorize the expenditure of \$80,578.36 from the Fleet Management Operating Fund; and to declare an emergency. (\$80,578.36)

WHEREAS, the City has a need for After Market Snow Plow Parts for use by the Department of Public Service for maintenance and upkeep of its snow removal vehicles; and

WHEREAS, the Purchasing Office advertised a formal bid (RFQ025121) for these parts, and

WHEREAS, the Finance and Management Department recommends a bid award to The Dexter Company as the overall lowest, responsive, and responsible bidder, for items 1-18; and

WHEREAS, the Finance and Management Department recommends a bid award to Kueper North America as the overall best, responsive, and responsible bidder, for item 19; and

WHEREAS, it is necessary to authorize the expenditure of \$80,578.36 from the Fleet Management Operating Fund; and

WHEREAS, an emergency exists in the usual daily operation of the Department of Finance and Management, Fleet Management Division, to authorize the Finance and Management Director to establish purchase orders for the purchase of After Market Snow Plow Parts in order to ensure these parts will be on hand in time for their seasonal need thereby preserving the public health, peace, property, safety, and welfare; and **NOW, THEREFORE**

BE IT ORDAINED BY THE COUNCIL OF THE CITY OF COLUMBUS:

SECTION 1. That the Finance and Management Director, on behalf of the Fleet Management Division, is hereby authorized to establish a purchase order with The Dexter Company, Inc. for the purchase of After

Market Snow Plow Parts, as follows:

Request for Quotation RFQ025121: The Dexter Company \$73,138.36

SECTION 2. That the Finance and Management Director, on behalf of the Fleet Management Division, is hereby authorized to establish a purchase order with Kueper North America for the purchase of After Market Snow Plow Parts, as follows:

Request for Quotation RFQ025121: Kueper North America \$7,440.00

SECTION 3. That the expenditure of \$80,578.36 or so much thereof as may be necessary in regard to the action authorized in Section 1 and Section 2, is hereby authorized in Fund 5200 Fleet Management Operating Fund, in object class 02 per the accounting codes in the attachment to this ordinance.

See Attached File: Ord 2121-2023 Legislation Template.xls

SECTION 4. That the monies in the foregoing Sections shall be paid upon order of the Director of Finance and Management, and that no order shall be drawn or money paid except by voucher, the form of which shall be approved by the City Auditor.

SECTION 5. That the funds necessary to carry out the purpose of this ordinance are hereby deemed appropriated, and the City Auditor shall establish such accounting codes as necessary.

SECTION 6. That the City Auditor is authorized to make any accounting changes to revise the funding source for all contracts or contract modifications associated with this ordinance.

SECTION 7. That for reasons stated in the preamble hereto, which is hereby made a part hereof, this ordinance is hereby declared an emergency measure and shall take effect and be enforced from and after its passage and approval by the Mayor, or ten days after passage if the Mayor neither approves nor vetoes the same.

Legislation Number: 2122-2023

Drafting Date: 7/6/2023

Current Status: Passed

Version: 1

Matter Type: Ordinance

Background: This ordinance authorizes the Finance and Management Director to establish purchase orders with Grimco Inc. (\$4,936.00) and Hyatt's Graphic Supply Co. Inc (\$64,440.95) for a total of \$69,376.95 for the purchase of Gerber and 3M films and foils per the results of bid RFQ025098. These films and foils will be used to replace and repair emblems and markings on City vehicles. This bid was processed in accordance with the competitive bidding provisions of Columbus City Code. Four (4) responses were received and opened for bid -RFQ025098 on June 29, 2023 as follows:

Grimco Inc., Vendor #023773, FID 43-0955083, Exp. 08/19/2024 - \$4,936.00

Hyatt's Graphic Supply Co. Inc, Vendor #000798, FID 16-0874429, Exp. 06/12/2025 - \$64,440.95

Flower Branch MFG Vendor #045716, FID 84-5065950, Exp. 06/14/2025

Technology International Inc Vendor #009840, FID 65-0342335, Exp. 05/12/2025

The Finance and Management Department therefore recommends that lines 3-4 of RFQ025098 be awarded to Grimco Inc, and lines 1-2 and line 5-10 of RFQ025098 be awarded to Hyatt's Graphic Supply Co. Inc as the

lowest, most responsive and responsible bidders.

Grimco Inc., Vendor #023773, FID 43-0955083 \$4,936.00

Hyatt's Graphic Supply Co. Inc, Vendor #000798, FID 16-0874429 \$64,440.95

Fiscal Impact: This ordinance authorizes an appropriation and expenditure of \$69,376.95 from 2023 Fleet Purchase Plan (ACPR002432) with Grimco Inc.(\$4,936.00) and Hyatt's Graphic Supply Co. Inc (\$64,440.95) for the purchase of Gerber and 3M films and foils. In 2022, the Fleet Management Division expended \$57,644.22 for Gerber and 3M films and foils and in 2020 expenditures were \$4,800.00 for Gerber and 3M films and foils.

Emergency action is requested to ensure that a purchase order can be established as quickly as possible. The need for these items has increased as backlogged vehicle orders begin to be completed, putting Fleet Management in need of these supplies to complete many critical city vehicles therefore emergency action is requested.

To authorize the Finance and Management Director, on behalf of the Fleet Management Division, to establish purchase orders with Grimco Inc and Hyatt's Graphic Supply Co. Inc, for the purchase of Gerber and 3M films and foils; and to authorize the expenditure of \$69,376.95 from 2023 Fleet Purchase Plan (ACPR002432); and to declare an emergency. (\$69,376.95)

WHEREAS, the City has a need for the purchase of Gerber and 3M films and foils for use at the Fleet Management Body Shop, and

WHEREAS, a formal bid (RFQ025098) was advertised on 06/07/2023, and

WHEREAS, the Finance and Management Department recommends a bid award to Grimco Inc. for lines 3-4 and a bid award to Hyatt's Graphic Supply Co Inc. for lines 1-2 and lines 5-10 as the overall lowest, responsive, and responsible bidders, and

WHEREAS, funding for these films and foils are budgeted and available within the Fleet Management Special Income Tax Fund 4430; and

WHEREAS, an emergency exists in the usual daily operation of the City in that it is immediately necessary to authorize the Finance and Management Director to establish a purchase order with Grimco Inc. for the purchase of Gerber and 3M films and foils as backlogged vehicle orders begin to be completed, putting Fleet Management in need of these supplies to complete many critical city vehicles ;

NOW, THEREFORE BE IT ORDAINED BY THE COUNCIL OF THE CITY OF COLUMBUS:

SECTION 1. That the Finance and Management Director, on behalf of the Fleet Management Division, is hereby authorized to establish purchase orders with Hyatt's Graphic Supply Co. Inc and Grimco Inc. for the purchase of Gerber and 3M films and foils, as follows:

Request for Quotation RFQ025098:

Grimco Inc., \$4,936.00.

Hyatt's Graphic Supply Co. Inc - \$64,440.95

SECTION 2. That the expenditure of \$69,376.95 or so much thereof as may be necessary, in regard to the actions authorized in Section 1 are hereby authorized and approved from the 2023 Fleet Purchase Plan (ACPR002432): Fund 4430, Special Income Tax Fund, Subfund 443001, Object Class 06, Program FL005.

SECTION 3. That the monies in the foregoing Sections shall be paid upon order of the Director of Finance and Management, and that no order shall be drawn or money paid except by voucher, the form of which shall be approved by the City Auditor.

SECTION 4. That the funds necessary to carry out the purpose of this ordinance are hereby deemed appropriated, and the City Auditor shall establish such accounting codes as necessary.

SECTION 5. That the City Auditor is authorized to make any accounting changes to revise the funding source for all contracts or contract modifications associated with this ordinance.

SECTION 6. That for reasons stated in the preamble hereto, which is hereby made a part hereof, this ordinance is hereby declared an emergency measure and shall take effect and be enforced from and after its passage and approval by the Mayor, or ten days after passage if the Mayor neither approves nor vetoes the same.

Legislation Number: 2124-2023

Drafting Date: 7/6/2023

Current Status: Passed

Version: 1

Matter Type: Ordinance

Background: This ordinance authorizes the appropriation of \$1,797,205.00 in the Community Development Block Grant (CDBG-CV) Fund 2248 to be applied towards the costs of the Glenwood and Windsor Pool Replacements Project via an expenditure correction.

Ordinance 1610-2022 authorized the Director of the Recreation and Parks Department to enter into contract with 2K General Company, in the amount of \$18,028,000.00 for the construction of the Glenwood and Windsor Pool Replacements Project. The project is well underway and is expected to be substantially complete in the summer of 2023. \$3,000,000.00 of this total contract was funded by the CDBG Fund 2248 in the original Ordinance 1610-2022, with the remaining \$15,028,000.00 being funded by the Recreation and Parks Voted Bond Fund 7702. This ordinance will authorize the Recreation and Parks Department to submit an expenditure correction to move \$1,797,205.00 more of this project to the CDBG Fund 2248. The funding is being provided by the Community Development Block Grant (CDBG-CV) Program, in conjunction with the CARES Act, and in accordance with the 2020 Amended Annual Action Plan. The funding split, as a result of this expenditure correction, will be \$4,797,205.00 from the CDBG-CV Fund 2248 and \$13,230,795.00 from the Recreation and Parks Voted Bond Fund 7702.

Emergency Justification: Emergency action is being requested as this project is nearing completion, the funding sources need to be corrected, and to meet the timeliness goals associated with the CDBG funding.

Benefits to the Public: This project benefits the public by improving two important recreational facilities that have served their respective communities for over 50 years. Improvements to our parks and facilities provide significant benefits to the quality of life in the neighborhoods in which they are located.

Community Input Issues: The community has expressed the desire for well-kept and updated facilities through public workshops, social media, and direct contact with City staff. As part of the Columbus Recreation and Parks Aquatic Capital Improvement Plan, residents in the service areas of these swimming pools were engaged through their Associations and Commissions.

Area(s) Affected: East Columbus (50), Greater Hilltop (53)

Master Plan Relation: This project supports the Columbus Recreation and Parks Department's Master Plan by improving existing aquatics facilities and helping to ensure that facilities remain safe and user friendly.

Fiscal Impact: \$1,797,205.00 is budgeted and available from within the CDBG-CV Fund 2248 to meet the financial obligations of this contract.

To authorize the appropriation of \$1,797,205.00 within the CDBG Fund in accordance with the 2020 Amended Annual Action Plan; to authorize an expenditure correction of \$1,797,205.00 from the Recreation and Parks Voted Bond Fund to the CDBG Fund for the Glenwood and Windsor Pool Replacements Project; and to declare an emergency. (\$1,797,205.00)

WHEREAS, it is necessary to authorize the appropriation of \$1,797,205.00 within the CDBG Fund 2248 and in accordance with the 2020 Amended Annual Action Plan as approved by Council; and

WHEREAS, it is necessary to authorize an expenditure correction of \$1,797,205.00 from the Recreation and Parks Voted Bond Fund 7702 to the CDBG Fund 2248 for the Glenwood and Windsor Pool Replacements Project; and

WHEREAS, an emergency exists in the usual daily operations of the Recreation and Parks Department in that it is immediately necessary to authorize this expenditure correction as this project is nearing completion, the funding sources need to be corrected, and to meet the timeliness goals associated with the CDBG funding, all for the preservation of public health, peace, property, safety, and welfare; **NOW, THEREFORE**

BE IT ORDAINED BY THE COUNCIL OF THE CITY OF COLUMBUS:

SECTION 1. That the appropriation of \$1,797,205.00 is authorized within the CDBG Fund 2248 per the accounting codes in the attachment to this ordinance and in accordance with the 2020 Amended Annual Action Plan as approved by Council.

SECTION 2. That an expenditure correction of \$1,797,205.00 is hereby authorized from the Recreation and Parks Voted Bond Fund 7702 to the CDBG-CV Fund 2248 for the Glenwood and Windsor Pool Replacements Project.

SECTION 3. That the funds necessary to carry out the purpose of this ordinance are hereby deemed appropriated, and the City Auditor shall establish such accounting codes as necessary.

SECTION 4. That the City Auditor is authorized to make any accounting changes to revise the funding source for all contracts or contract modifications associated with this ordinance.

SECTION 5. That the City Auditor is hereby authorized to transfer the unencumbered balance in a project account to the unallocated balance account within the same fund upon receipt of certification by the Director of the Department administering said project that the project has been completed and the monies are no longer

required for said project.

SECTION 6. That for the reasons stated in the preamble hereto, which is hereby made a part hereof, this ordinance is hereby declared to be an emergency measure and shall take effect and be in force from and after its passage and approval by the Mayor, or 10 days after passage if the Mayor neither approves nor vetoes the same.

Legislation Number: 2125-2023

Drafting Date: 7/6/2023

Current Status: Passed

Version: 1

Matter Type: Ordinance

BACKGROUND:

The City is required to authorize the acquisition and acceptance of any real estate conveyed to the City. This means periodically the City must formally accept certain real estate previously conveyed to the City (defined, collectively, “Real Estate,” and further described in Sections One (1), Two (2), and Three (3) of this ordinance), because the Real Estate was not the subject of any previous legislation authorizing the Real Estate’s acquisition and acceptance.

The City is using the Real Estate for various public purposes, including but not limited to sewerage, drainage, water, electric, and other general utilities, pedestrian and vehicular traffic control, pedestrian and vehicular access and parking, parkland and conservation, landscaping, signs, ADA compliant sidewalks, walkways, bikeways, access, and shared use paths, and associated appurtenances. The Real Estate was recorded in the public land records in the applicable county in the state of Ohio. Additionally, it may be necessary for the City to enter into agreements, as approved by the City Attorney, with the grantors of the Real Estate in order to address any real estate tax or assessment implications associated with the City’s acquisition and acceptance of the Real Estate.

CONTRACT COMPLIANCE:

Not applicable.

FISCAL IMPACT:

Not applicable.

EMERGENCY JUSTIFICATION:

Not applicable.

To formally accept certain real estate conveyed to the City that is being used for various public purposes; and to authorize the directors of the Departments of Public Utilities, Public Service, Finance and Management, Development, and Recreation and Parks to enter into any necessary agreements, as approved by the City Attorney's Office, in order to address any real estate tax or assessment issues. (\$0.00)

WHEREAS, the City intends to formally accept certain real estate conveyed to the City (i.e. Real Estate); and

WHEREAS, the City intends to use the Real Estate for various public purposes; and

WHEREAS, the City intends for the directors of the Departments of Public Utilities, Public Service, Finance and Management, Development, Recreation and Parks to enter into any necessary agreements with the grantors of the Real Estate in order to address any real estate tax or assessment implications associated with the Real Estate's acquisition and acceptance; and

WHEREAS, the City intends for the City Attorney to pre-approve all documents executed by City personnel pursuant to authority granted by this ordinance; **NOW, THEREFORE:**

BE IT ORDAINED BY THE COUNCIL OF THE CITY OF COLUMBUS:

SECTION 1. The City formally accepts the following described real estate previously conveyed to the City and recorded in the public land records of the Recorder's Office, Franklin County, Ohio (i.e. Real Estate), which is being used for various public purposes, including but not limited to sewerage, drainage, water, electric, and other general utilities, pedestrian and vehicular traffic control, pedestrian and vehicular access and parking, parkland and conservation, landscaping, signs, ADA compliant sidewalks, walkways, bikeways, access, and shared use paths, and associated appurtenances:

Grantor(s)...Franklin County Recorder Reference...(Real Estate)

1. **Huyen Ninh:** Ins. 202303230027733 (Sanitary Sewer Utility Easement)
2. **Graces Corner Bex-Livingston LLC:** Ins. 202303230027732 (Stormwater Control Practices Easement)
3. **Retreat At Gender, LLC:** Ins. 202303230027731 (Sanitary Sewer Utility Easement)
4. **Prushing Farms Partners, LLC:** Ins. 202303230027730 (Preservation Easement)
5. **Prushing Farms Partners, LLC:** Ins. 202303230027729 (Sanitary Sewer Utility Easement)
6. **0 Outerbelt Street, LLC:** Ins. 202303230027726 (Sanitary Sewer Utility Easement)
7. **West 70 Three Owner, LLC:** Ins. 202303150024352 (Sanitary Sewer Utility Easement)
8. **2228 Alum Creek Road LLC:** Ins. 202303130023300 (Preservation Easement)
9. **My Property Holdings-8910 W. 191St. Ins.:** 202303130023299 (Stormwater Control Practices Easement)
10. **MAK Real Estate, LLC:** Ins. 202303070021513 (Stormwater Control Practices Easement)
11. **AIP Properties, LLC:** Ins. 202303070021512 (Stormwater Control Practices Easement)
12. **Easton Lodging, LLC:** Ins. 202303070021511 (Stormwater Control Practices Easement)
13. **American Self-Storage of Grove City, LLC:** Ins. 202303070021510 (Stormwater Control Practices Easement)
14. **Ballet Metropolitan, Inc.:** Ins. 202302280018809 (Water Utility Easement)
15. **Kirk and Ackley Enterprises, Inc.:** Ins. 202302280018806 (Temporary Construction Easement)
16. **Kirk and Ackley Enterprises, Inc.:** Ins. 202302280018805 (Water Utility Easement)
17. **Stanford M. Ackley:** Ins. 202302280018804 (Temporary Construction Easement)
18. **Stanford M. Ackley:** Ins. 202302280018803 (Water Utility Easement)
19. **Half Baked Holdings, LLC:** Ins. 202302210016418 (Sewer Utility Easement)
20. **Broughton Investments LLC:** Ins. 202302210016417 (Stormwater Control Practices Easement)
21. **303 East Sixth, LLC:** Ins. 202302130014038 (Stormwater Control Practices Easement)
22. **The Winchester OZB LLC:** Ins. 202302130014037 (Stormwater Control Practices Easement)
23. **Rumpke of Ohio, Inc.:** Ins. 202302060011671 (Sanitary Sewer Utility Easement)
24. **Rumpke of Ohio, Inc.:** Ins. 202302060011670 (Stormwater Control Practices Easement)
25. **Chambers Road Holdings LLC:** Ins. 202302060011669 (Stormwater Control Practices Easement)
26. **Retreat at Gender, LLC:** Ins. 202302060011668 (Sanitary Sewer Utility Easement)

27. **Retreat at Gender, LLC:** Ins. 202302060011667 (Stormwater Control Practices Easement)
28. **The Davey Tree Expert Company:** Ins. 202302020010760 (Stormwater Control Practices Easement)
29. **The Winchester OZB LLC:** Ins. 202301260008419 (Sewer and Drainage Utility Easement)
30. **Zeebot, LLC:** Ins. 202301200006533 (Water Utility Easement)
31. **City Winery Columbus, LLC:** Ins. 202301200006532 (Stormwater Control Practices Easement)
32. **Park Crescent Investments, LLC:** Ins. 202301200006531 (Stormwater Control Practices Easement)
33. **SFG ISF Columbus 0 Buckeye, LLC:** Ins. 202301200006530 (Stormwater Control Practices Easement)
34. **London Groveport STS, LLC:** Ins. 202301180005584 (Access Easement)
35. **Astor Park Commercial Condominium:** Ins. 202301180005583 (Stormwater Control Practices Easement)
36. **The State of Ohio:** Ins. 202301180005582 (Amendment to Easement Recorded in Instrument 201706230085609)
37. **SFG ISF II Columbus Lockbourne, LLC:** Ins. 202301180005577 (Stormwater Control Practices Easement)
38. **Indus Outerbelt Hotel, LLC:** Ins. 202301100002755 (Sanitary Sewer Utility Easement)
39. **Indus Outerbelt Hotel, LLC:** Ins. 202301100002754 (Stormwater Control Practices Easement)
40. **Cologix Col4, LLC:** Ins. 202301100002751 (Stormwater Control Practices Easement)
41. **Tucker Bear Capital, LLC:** Ins. 202301100002750 (Sanitary Sewer Utility Easement)
42. **MVP I-A 2020 L.L.C.:** Ins. 202301100002749 (Sanitary Sewer Utility Easement)
43. **Shook Road Storage, LLC:** Ins. 202301050001235 (Storm Sewer Utility Easement)
44. **OIS Properties, LLC:** Ins. 202301050001234 (Stormwater Control Practices Easement)
45. **LGW STS, LLC:** Ins. 202212200170782 (Perpetual Access Easement for Ingress/Egress)
46. **SLPJEP, L.L.C.:** Ins. 202212200170780 (Stormwater Control Practices Easement)
47. **Ekalavya Ventures, LLC:** Ins. 202212200170778 (Stormwater Control Practices Easement)
48. **Tucker Bear Capital, LLC:** Ins. 202212200170777 (Preservation Easement)
49. **Fred J. Mack, LLC:** Ins. 202212200170776 (Stormwater Control Practices Easement)
50. **Homewood Corporation:** Ins. 202212200170774 (Limited Warranty Deed Parkland Dedication)
51. **WN High Street, LLC:** Ins. 202212120166977 (Stormwater Control Practices Easement)
52. **Trulieve OH, Inc.:** Ins. 202212120166975 (Stormwater Control Practices Easement)
53. **MORSO Holding Co.:** Ins. 202212120166974 (Access Easement)
54. **Easton Place Homes, LLC:** Ins. 202212120166973 (Stormwater Control Practices Easement)
55. **Pulte Homes of Ohio LLC:** Ins. 202212120166971 (Stormwater Control Practices Easement)
56. **Tucker Bear Capital, LLC:** Ins. 202212090166476 (Electric Utility Easement)
57. **Elan Park LLC:** Ins. 202212050164294 (Preservation Easement)
58. **Elan Park LLC:** Ins. 202212050164293 (Stormwater Control Practices Easement)
59. **Blackfriars Development, LLC:** Ins. 202212050164292(Stormwater Control Practices Easement)
60. **JPG on Georgesville, LLC:** Ins. 202211280161560 ((Stormwater Control Practices Easement (RR 202212120166976))
61. **Sheetz, Inc.:** Ins. 202211280161511 (Stormwater Control Practices Easement)
62. **Local Waste Properties, LLC:** Ins. 202211280161510 (Stormwater Control Practices Easement)
63. **Columbus Regional Airport Authority:** Ins. 202211280161509 (Water Utility Easement)
64. **CD Real Estate Investments, P.L.L.:** Ins. 202211280161507 (Preservation Easement)
65. **CD Real Estate Investments, P.L.L.:** Ins. 202211280161506 (Stormwater Control Practices Easement)
66. **Graceland Retail 2017, LLC:** Ins. 202211140156499 (Preservation Easement)
67. **Graceland Owner, LLC:** Ins. 202211140156498 (Preservation Easement)
68. **Graceland Retail 2017, LLC:** Ins. 202211140156497 (Stormwater Control Practices Easement)

69. **Graceland Owner, LLC:** Ins. 202211140156496 (Stormwater Control Practices Easement)
70. **Graceland Retail 2017, LLC:** Ins. 202211140156495 (Stormwater Control Practices Easement)
71. **100 North High Street, LLC:** Ins. 202211140156298 (Sidewalk/Shared Use Path Easement)
72. **WC ECP Monarch, LLC:** Ins. 202211140156297 (Sidewalk/Shared Use Path Easement)
73. **JB Wright Company LLC:** Ins. 202211070154205 (Stormwater Control Practices Easement)
74. **The Retreat at Scioto Creek, L.P.:** Ins. 202211070154203 (Preservation Easement)
75. **Pulte Homes of Ohio, LLC:** Ins. 202211070154202 (General Warranty Deed Parkland Dedication)
76. **OIS Properties, LLC:** Ins. 202211010151690 (Sidewalk/Shared Use Path Easement)
77. **Awesome Possum Storage LTD:** Ins. 202211010151599 (Stormwater Control Practices Easement)
78. **Columbus Godown, LLC:** Ins. 202211010151598 (Stormwater Control Practices Easement)
79. **Cardinal Self Storage West Albany LLC:** Ins. 202211010151597 (Stormwater Control Practices Easement)
80. **GAPT, LLC:** Ins. 202211010151596 (Stormwater Control Practices Easement)
81. **Triple J&R Homes Ohio, LLC:** Ins. 202210260149210 (Water Utility Easement)
82. **Triple J&R Homes Ohio, LLC:** Ins. 202210260149209 (Temporary Construction Easement)
83. **West 70 Two Owner, LLC:** Ins. 202210260149208 (Stormwater Control Practices Easement)
84. **West 70 Land Owner, LLC:** Ins. 202210260149207 (Stormwater Control Practices Easement)
85. **CN Express, LLC:** Ins. 202210260149205 (Preservation Easement)
86. **CN Express, LLC:** Ins. 202210260149204 (Stormwater Control Practices Easement)
87. **SL Grant Park Owner, LLC:** Ins. 202210260149203 (Stormwater Control Practices Easement)
88. **Grant Park Apartments Five, LLC:** Ins. 202210260149202 (Stormwater Control Practices Easement)
89. **Mile 26 Trucking Parking LLC:** Ins. 202210260149201 (Stormwater Control Practices Easement)
90. **SC Thurber Limited:** Ins. 202210200147018 (Sanitary Sewer Utility Easement)
91. **Wehinger VI, LTD:** Ins. 202210200147017 (Stormwater Control Practices Easement)
92. **The Retreat at Scioto Creek, L.P.:** Ins. 202210200147016 (Stormwater Control Practices Easement)
93. **The Retreat at Scioto Creek, L.P.:** Ins. 202210200147014 (Preservation Easement)
94. **WX2 Ventures, LLC:** Ins. 202210200147013 (Stormwater Control Practices Easement)
95. **Fed Eagle Two, LLC:** Ins. 202210170145473 (Stormwater Control Practices Easement)
96. **SC Thurber Village Limited:** Ins. 202210170145472 (Stormwater Control Practices Easement)
97. **South High Warehouse, LLC:** Ins. 202210130144217 (Stormwater Control Practices Easement)
98. **Dalton Apartments LLC:** Ins. 202210130144216 (Stormwater Control Practices Easement)
99. **Czar Properties, LLC:** Ins. 202210130144215 (Stormwater Control Practices Easement)
100. **Dalton Apartments LLC:** Ins. 202210050140928 (Sanitary Sewer Utility Easement)
101. **The Orchards at Scioto Downs LLC:** Ins. 202210050140927 (Stormwater Control Practices Easement)
102. **The Orchards at Scioto Downs LLC:** Ins. 202210050140926 (Sanitary Sewer Utility Easement)
103. **The Orchards at Scioto Downs LLC:** Ins. 202210050140925 (Preservation Easement)
104. **Columbus Metropolitan Housing Authority:** Ins. 202210050140924 (Stormwater Control Practices Easement)
105. **RAP Walcutt, LLC:** Ins. 202210050140923 (Sanitary Sewer Utility Easement)
106. **1179 East Main Ventures LLC:** Ins. 202210050140921 (Stormwater Control Practices Easement)
107. **JPG on Georgesville, LLC:** Ins. 202210050140920 (Sanitary Sewer Utility Easement)
108. **The Ohio State University:** Ins. 202209220134917 (Sanitary Sewer Utility Easement)
109. **KIPP Columbus Foundation:** Ins. 202209220134916 (Sanitary Sewer Utility Easement)
110. **1179 East Main Ventures LLC:** Ins. 202209220134915 (Sanitary Sewer Utility Easement)
111. **Franklin Apartments I QOZB, LLC:** Ins. 202209220134914 (Sewer and Water Utility Easement)

112. **3500 ACD, LLC:** Ins. 202209220134913 (Stormwater Control Practices Easement)
113. **3500 ACD, LLC:** Ins. 202209220134904 (Water Utility Easement)
114. **The Ohio State University:** Ins. 202209220134903 (Storm Sewer Utility Easement)
115. **W & D Davis Investment Co., LTD:** Ins. 202209200133542 (Stormwater Control Practices Easement)
116. **1948 Holdings, LLC:** Ins. 202209200133541 (Stormwater Control Practices Easement)
117. **Erie Land Co., LLC:** Ins. 202209200133540 (Stormwater Control Practices Easement)
118. **Earl K. Fernandes, Bishop the Catholic Diocese of Columbus:** Ins. 202209140131409 (Stormwater Control Practices Easement)
119. **Lakeside Village LLC:** Ins. 202209140131407 (Preservation Easement)
120. **Lakeside Village LLC:** Ins. 202209140131406 (Stormwater Control Practices Easement)
121. **Directions for Youth & Families Group, LLC:** Ins. 202209140131403 (Stormwater Control Practices Easement)
122. **Arlington Ave Ventures I LLC:** Ins. 202209120130030 (Pedestrian Sidewalk and Utility Easement)
123. **Darby Crossing Apartments, L.P.:** Ins. 202209090129236 (Storm Sewer Utility Easement)
124. **Darby Crossing Apartments, L.P.:** Ins. 202209090129235 (Storm Sewer Utility Easement (RR 202210050140919))
125. **Darby Crossing Apartments, L.P.:** Ins. 202209090129234 (Preservation Easement)
126. **Darby Crossing Apartments, L.P.:** Ins. 202209090129233(Stormwater Control Practices Easement)
127. **GMT Property Holdings, LLC and Rock Capital Holdings, LLC:** Ins. 202209090129232 (Preservation Easement)
128. **GMT Property Holdings, LLC and Rock Capital Holdings, LLC:** Ins. 202209090129231 (Stormwater Control Practices Easement)
129. **GMT Property Holdings, LLC and Rock Capital Holdings, LLC:** Ins. 202209090129230 (Stormwater Control Practices Easement)
130. **GWB Realty, LLC:** Ins. 202209090129229 (Stormwater Control Practices Easement)
131. **Young Scholars of Columbus Incorporated:** Ins. 202209090129228 (Stormwater Control Practices Easement)
132. **Compton Brookfield, LLC:** Ins. 202209090129227 (Stormwater Control Practices Easement)
133. **Charter Street Storage, LLC:** Ins. 202209090129226 (Stormwater Control Practices Easement)
134. **Noble Academy-Columbus, Inc.:** Ins. 202209090129225 (Stormwater Control Practices Easement)
135. **WC ECP Monarch, LLC:** Ins. 202209090129224 (Storm Sewer Utility Easement)
136. **QT Apartments II, LLC:** Ins. 202209090129223 (Public and Private Access Easement for Ingress/Egress and Roadway)
137. **Marble Cliff Quarry Community Authority:** Ins. 202209090129222 (Public and Private Access Easement for Ingress/Egress and Roadway)
138. **Marble Cliff Canyon, LLC:** Ins. 202209090129221 (Stormwater Control Practices Easement)
139. **Allegheny West Conference Corporation of Seventh-Day Adventists:** Ins. 202208310125390 (Stormwater Control Practices Easement)
140. **The Clark Grave Vault Company:** Ins. 202208310125389 (Stormwater Control Practices Easement)
141. **Lusso-1 Partners LLC:** Ins. 202208310125388 (Stormwater Control Practices Easement)
142. **Lusso-2 Partners, LLC:** Ins. 202208310125387 (Stormwater Control Practices Easement)
143. **Moo Moo Hamilton Quarter, LLC:** Ins. 202208090115179 (Sanitary Sewer Utility Easement)
144. **The Residences at Eden Park LLC:** Ins. 202206290095842 (Sidewalk/Shared Use Path Easement)
145. **GMT Property Holdings, LLC and Rock Capital Holdings, LLC:** Ins. 202206090086463 (Fire and Police Ingress/Egress Access Easement)
146. **Chesapeake Avenue Holdings, LLC:** Ins. 202204280065498 (Sidewalk/Shared Use Path Easement)

147. **Homewood Corporation:** Ins. 202204010050895 (Emergency Service Ingress/Egress Access Easement)
148. **Pizzuti GE, LLC:** Ins. 202204010050893 (Sidewalk/Shared Use Path and Utility Easement)
149. **Residences at Towne Center Holdings, LTD:** Ins. 202203070035825 (Sidewalk/Shared Use Path and Utility Easement)
150. **Residences at Towne Center Holdings, LTD:** Ins. 202203030035024 (Sidewalk/Shared Use Path and Utility Easement)
151. **Gender Road Investors, LLC:** Ins. 202201130009773 (General Warranty Deed Parkland Dedication)
152. **Pulte Homes of Ohio, LLC:** Ins. 202112300233493 (General Warranty Deed Parkland Dedication)
153. **Arlington Ave Ventures I LLC:** Ins. 202112220231463 (General Warranty Deed Parkland Dedication)
154. **Agler Joint Venture, LLC:** Ins. 202112020218952 (General Warranty Deed Parkland Dedication)
155. **Willow Brook Christian Communities:** Ins. 202109020156763 (Perpetual Highway Easement Without Limitation of Access and Temporary Construction Easement)
156. **Easton Gateway, LLC:** Ins. 201912310175863 (Sidewalk/Shared Use Path Easement)
157. **Multicon Development Company:** Ins. 201406130074287 (Sidewalk/Shared Use Path Easement)
158. **Randall Hall:** Ins. 201301250013003 (Pedestrian Sidewalk Easement)
159. **Gender Road Office Park, LLC:** Ins. 201204130051170 (Pedestrian Sidewalk Easement)
160. **Board of Education of the Columbus City School District:** Ins. 201204130051168 (Pedestrian Sidewalk and Utility Easement)
161. **Board of Education of the Columbus City School District:** Ins. 201204130051166 (Pedestrian Sidewalk and Utility Easement)
162. **Stratford Asset Management, LLC, Stratford Equities Limited Partnership, and Oak Creek Holdings Limited:** Ins. 201202170022462 (Pedestrian Sidewalk Easement)
163. **Front Street Brewing II, LLC:** Ins. 201201200008472 (Pedestrian Sidewalk Easement)
164. **Board of Education of the Columbus City School District:** Ins. 201201060002385 (Pedestrian Sidewalk Easement)
165. **Menard, Inc.:** Ins. 201112160164124 (Pedestrian Sidewalk Easement)
166. **Nationwide Mutual Insurance Company:** Ins. 201112020156933 (Pedestrian Sidewalk Easement)
167. **Saeed Kharazi and Kimberly Sue Davis:** Ins. 201111210151620 (Pedestrian Sidewalk Easement)
168. **Mt. Zion Missionary Baptist Church:** Ins. 201108020095275 (Perpetual Access Easement for Ingress/Egress)
169. **Plain Local Schools District, Franklin County, Ohio:** Ins. 201105200064762 (Pedestrian Sidewalk Easement)
170. **Epcon Hayden Run, LLC:** Ins. 201003120029594 (Pedestrian Sidewalk Easement)
171. **Ben W. Hale, Jr., Trustee aka Ben Hale Jr. Trustee for The Lurie 1985 Children's Trust:** Ins. 201003120029579 (Pedestrian Sidewalk Easement)
172. **The Lurie Family Limited Partnership:** Ins. 201003120029576 (Pedestrian Sidewalk Easement)
173. **Hayden's Reserve Condominium Community:** Ins. 200912310188611 (Temporary Construction Easement)
174. **The Woods at Hayden Run Condominium Association:** Ins. 200912310188609 (Perpetual Slopes Easement)
175. **The Woods at Hayden Run Condominium Association:** Ins. 200912310188608 (Pedestrian Sidewalk Easement)
176. **The Woods at Hayden Run Condominium Association:** Ins. 200912310188607 (Temporary Construction Easement)
177. **ZBP-K LLC and EV II, LLC:** Ins. 200911200166975 (Pedestrian Sidewalk Easement)

178. **Alpha Investments I, LLC:** Ins. 200910160149285 (Pedestrian Sidewalk Easement)
179. **Retail Properties Limited:** Ins. 200909040129886 (Pedestrian Sidewalk Easement)
180. **Ohio Dominican College:** Ins. 200908060115224 (Pedestrian Sidewalk Easement)
181. **Frazier Development, Inc.:** Ins. 200908060115221 (Pedestrian Sidewalk Easement)
182. **First Church of God, Inc.:** Ins. 200908060115219 (Temporary Vehicle Turnaround Easement)
183. **Columbus Jewish Foundation and Robert N. Shamansky Co-Trustees of the 2008 Robert N. Shamansky-Nationwide Children's Hospital Charitable Remainder Annuity Trust:** Ins. 200908060115217 (Pedestrian Sidewalk Easement)
184. **Hayden Leppert West LLC:** Ins. 200907020096356 (Perpetual Slope Easement)
185. **Randcorp Holdings, LLC:** Ins. 200907020096354 (Pedestrian Sidewalk Easement)
186. **The Falls at Hayden Run Condominium:** Ins. 200907020096350 (Pedestrian Sidewalk Easement)
187. **The Falls at Hayden Run, LTD:** Ins. 200907020096349 (Perpetual General Utility Easement)
188. **Falls at Hayden Retail, LTD:** Ins. 200907020096346 (Pedestrian Sidewalk Easement)
189. **The Falls at Hayden Run Master Association:** Ins. 200907020096344 (Pedestrian Sidewalk Easement)
190. **JAP GURU LLC:** Ins. 200903100033147 (Pedestrian Sidewalk Easement)
191. **East Side Grace Brethren Church of Blacklick, Ohio:** Ins. 200810310160782 (Pedestrian Sidewalk Easement)
192. **Mt. Zion Missionary Baptist Church:** Ins. 200809190141425 (Pedestrian Sidewalk Easement)
193. **Templo Cristiano Emanuel of Columbus, Ohio:** Ins. 200807100105823 (Pedestrian Sidewalk Easement)
194. **The Huntington National Bank:** Ins. 200806200094942 (Bikeway/Walkway Easement)
195. **Board of Education of the Columbus City School District:** Ins. 200806200094936 (Pedestrian Sidewalk Easement)
196. **Easton Town Center II, LLC:** Ins. 200805270080602 (Pedestrian Sidewalk Easement)
197. **Ohio Dominican University:** Ins. 200805270080599 (Pedestrian Sidewalk Easement)
198. **The National Board of Boiler and Pressure Vessel Inspectors:** Ins. 200805270080597 (Pedestrian Sidewalk Easement)
199. **Grange Mutual Casualty Company:** Ins. 200805060069859 (Pedestrian Sidewalk Easement)
200. **Airport Land LLC:** Ins. 200804280064447 (Public and Private Access Easement for Ingress/Egress)
201. **Columbus State Community College District Board of Trustees:** Ins. 200804280064446 (Pedestrian Sidewalk Easement)
202. **Columbus State Community College District Board of Trustees:** Ins. 200804210060110 (Pedestrian Sidewalk Easement)
203. **Board of Education of the Columbus City School District:** Ins. 200803240044189 (Pedestrian Sidewalk Easement)
204. **Mosaica Columbus, LLC:** Ins. 200802150023606 (Pedestrian Sidewalk Easement)
205. **Mosaica Columbus, LLC:** Ins. 200802150023605 (Perpetual General Utility Easement)
206. **Polaris EM, LLC:** Ins. 200709140162394 (Pedestrian Sidewalk Easement)

SECTION 2. The City formally accepts the following real estate previously conveyed to the City that were recorded in the public land records of the Recorder's Office, Delaware County, Ohio (i.e. Real Estate), which are being used for various public purposes, including but not limited to sewerage, drainage, water, electric, and other general utilities, pedestrian and vehicular traffic control, pedestrian and vehicular access and parking, parkland and conservation, landscaping, signs, ADA compliant sidewalks, walkways, bikeways, access, and shared use paths, and associated appurtenances.

Grantor(s)...Delaware County Recorder Reference...(Real Estate)

1. **Polaris 1.7 Outlot G, LLC:** D.B. 2014, Pg. 2085 - 2088 (Water Utility Easement)
2. **Polaris 1.7 Outlot G, LLC:** D.B. 2013, Pg. 2491 - 2499 (Stormwater Control Practices Easement)
3. **NP/FG, LLC:** D.B. 2010, Pg. 2306 - 2309 (Sanitary Sewer Utility Easement)
4. **Polaris BFS, LLC:** D.B. 870, Pg. 1597 - 1599 (Pedestrian Sidewalk Easement)

SECTION 3. The City formally accepts the following real estate previously conveyed to the City that were recorded in the public land records of the Recorder’s Office, Fairfield County, Ohio (i.e. Real Estate), which are being used for various public purposes, including but not limited to sewerage, drainage, water, electric, and other general utilities, pedestrian and vehicular traffic control, pedestrian and vehicular access and parking, parkland and conservation, landscaping, signs, ADA compliant sidewalks, walkways, bikeways, access, and shared use paths, and associated appurtenances.

Grantor(s)...Fairfield County Recorder Reference...(Real Estate)

1. **The Hause-Frye Family Revocable Living Trust, dated July 23, 2018:** Ins. 202300000617 (Cart Path Ingress/Egress Access Easement)

SECTION 4. The directors of the Departments of Public Utilities, Public Service, Finance and Management, Development, and Recreation and Parks are authorized to enter into any necessary agreements with the grantors of the Real Estate in order to address any real estate tax or assessment issues.

SECTION 5. The City Attorney is required to pre-approve all documents executed by the City pursuant to this ordinance.

SECTION 6. This ordinance shall take effect and be in force from and after the earliest period allowed by law.

Legislation Number: 2126-2023

Drafting Date: 7/6/2023

Version: 1

Current Status: Passed

Matter Type: Ordinance

BACKGROUND: Authorization is needed for the Director of the Department of Development to enter into a 5 year lease agreement for the property at 925-927 Mt. Vernon Avenue, Columbus, Ohio 43203 (Franklin County Tax Parcel № 010-041015) to Maroon Arts Group, an Ohio nonprofit corporation, who is currently operating the MPACC Boypark at the site. The project was one of the winners of the City’s Parcel to Places grant competition and is currently licensing the site under yearly agreements. This legislation authorizes the Director of Development to enter into the necessary lease agreement as needed for the use, operation, lease, and management of the property by Maroon Arts Group.

FISCAL IMPACT: The City will collect “Rent” defined as lessee’s annual rental payment to the City in the amount of Three Hundred Sixty Dollars and 00/100 U.S. Dollars (\$360.00), which is calculated at \$.015 per square foot per year.

To authorize the Director of the Department of Development to enter into the necessary lease agreement as needed for the use, operation, lease, and management of 925-927 Mt. Vernon Avenue, Columbus, Ohio 43203 (010-041015) by Maroon Arts Group.

WHEREAS, by Ordinance 1325-98, Council adopted and elected to use the Revised Code Chapter 5722, Land Reutilization Program, to facilitate effective reutilization of nonproductive land acquired through a sale pursuant to a foreclosure proceeding initiated by the Franklin County Treasurer, or through a sale of forfeited lands by the Franklin County Auditor, or through a conveyance in lieu of foreclosure to foster either return of such land to tax revenue generating status or its devotion to public use, or any other land acquired as part of the land reutilization program; and

WHEREAS, a proposal for the lease of the property which was acquired pursuant to Ohio Revised Code Section 5722.06 meets the Land Reutilization Program's Lease Policies and Guiding Principles and has been approved by the Land Redevelopment Office Administrator; and

WHEREAS, in conformity with Columbus City Code Section 329.33 which requires the lease of land reutilization properties for a term that exceeds one year to be authorized by Council. In order to complete the lease agreement of such property to the lessee, authority is needed for the Director of the Department of Development to execute any and all necessary lease agreements for the real property; and

WHEREAS, in order to complete the conveyance of such property to the lessee, authority is needed for the Department of Development, to execute any and all necessary agreements and leases for the real property;
NOW, THEREFORE,

BE IT ORDAINED BY THE COUNCIL OF THE CITY OF COLUMBUS:

SECTION 1. That the Director of the Department of Development is hereby authorized to execute any and all necessary lease agreements for the use, operation, lease, and management of the property, as determined by the Director of the Department of Development, of the following parcel of real estate to Maroon Arts Group:

PARCEL NUMBER: 010-041015
ADDRESS: 925-927 Mt. Vernon Avenue, Columbus, Ohio 43203
RENT: \$360.00 per year
USE: Community Garden & Urban Farming

SECTION 2. For the property stated in Section 1, that the Director of Development is hereby authorized to execute any agreements to ensure compliance with land bank program rules.

SECTION 3. That Council hereby finds that the selection process utilized in this matter is in accordance with the Land Bank Policies created pursuant to the City's Land Reutilization Program and hereby approves the same.

SECTION 4. That this ordinance shall take effect and be in force from and after the earliest period allowed by law.

Legislation Number: 2134-2023

Drafting Date: 7/7/2023

Current Status: Passed

Version: 1

Matter Type: Ordinance

To amend the Management Compensation Plan, Ordinance No. 2713-2013, as amended, by amending Sections 4(D) and 5(E); and to declare an emergency.

WHEREAS, it is necessary to amend the Management Compensation Plan by amending Section 4(D) to update the 50-60 pay structure; and

WHEREAS, it is necessary to amend the Management Compensation Plan by enacting the classification of Inspector General Intake Specialist (2999) and to assign it to Pay Grade 91 in Section 5(E); and

WHEREAS, it is necessary to amend the Management Compensation Plan by amending Section 5(E) to correct the classification title of Employee Benefits and Wellness Manager (0276); and

WHEREAS, it is necessary to amend the Management Compensation Plan by amending Section 5(E) to correct the classification title of Employee Benefits and Wellness Supervisor (0275); and

WHEREAS, it is necessary to amend the Management Compensation Plan by amending Section 5(E) to remove the classification title of Occupational Safety Manager (0282) while preserving the classification title of Citywide Occupational Safety and Health Manager (0282); and

WHEREAS, an emergency exists in the usual daily operation of the Department of Human Resources in that it is immediately necessary to amend certain provisions of the Management Compensation Plan in order to meet obligations to employees, departments, and the Civil Service Commission, by amending the established pay plan by July 31, 2023, thereby preserving the public peace, property, health, safety, **NOW, THEREFORE**,

BE IT ORDAINED BY THE COUNCIL OF THE CITY OF COLUMBUS:

SECTION 1. That Sections 4(D) and 5(E) of Ordinance No. 2713-2013 are hereby amended to read as follows according to the attached document:

Ord 2134-2023 Amending Ord 2713-2013 Sections 4 & 5 - 073123

SECTION 2. That existing Sections 4(D) and 5(E) of Ordinance No. 2713-2013, as amended, are hereby repealed.

SECTION 3. That for reasons stated in the preamble hereto, which is hereby made a part hereof, this ordinance is declared to be an emergency measure and the remaining sections of this ordinance shall take effect and be in force from and after its passage and approval by the Mayor, or ten days after passage if the Mayor neither approves nor vetoes the same.

Legislation Number: 2142-2023

Drafting Date: 7/7/2023

Current Status: Passed

This ordinance authorizes the Director of the Department of Technology (DoT) to renew a contract with Brown Enterprises LLC for Smartsheet Control Center subscriptions and licenses for various city departments. Smartsheet is used by several city agencies as it is (and can be) used to collaborate on project timelines, documents, calendars, assignments and related tasks. Smartsheet’s relatively simple user interface centers on "smartsheets," similar to other popular spreadsheets. Additionally, Smartsheet can import data from other applications, such as Microsoft Office or Google.

In July of 2021, DoT received four (4) responses to RFQ019097. Brown Enterprises LLC submitted the lowest, responsive quote and was awarded the contract. The original contract, authorized by ordinance 1926-2021 and passed on July 19, 2021, contained language allowing for up to three (3) renewals with mutual agreement by all interested parties. This ordinance authorizes the second of the three (3) allowable renewals for a one-year term, beginning on September 1, 2023 and ending on August 31, 2024.

Finally, this ordinance authorizes the expenditure of up to \$ 158,529.00 for the above-described purpose.

FISCAL IMPACT

Funds to cover the cost of this service have been identified and are available in the Department of Technology, Information Services Operating Fund.

CONTRACT COMPLIANCE

Vendor Name: Brown Enterprises LLC
DAX Vendor #: 010668, Expiration Date 12-31-2023

EMERGENCY

Emergency designation is sought as the current contract expires on August 31, 2023. In order to have a new contract in place, and ensure continuity of service, emergency designation is needed.

To authorize the Director of the Department of Technology to renew a contract with Brown Enterprises LLC for Smartsheet Control Center subscriptions and licenses; to authorize the expenditure of up to \$158,529.00 from the Department of Technology, Information Services Operating Fund for the above-mentioned purpose; and to declare an emergency. (\$158,529.00)

WHEREAS, on July 2, 2021, Brown Enterprises LLC submitted the lowest responsive bid in response to solicitation RFQ019097 for Smartsheet Control Center subscriptions and licenses; and

WHEREAS, ordinance 1926-2021, passed on July 19, 2021, authorized the original contract; and

WHEREAS, the original contract allowed for up to three renewals by mutual agreement and authorization by interested parties; and

WHEREAS, the Department of Technology desires to exercise the second of three (3) allowable renewals by entering into contract with Brown Enterprises LLC, beginning on September 1, 2023 and ending on August 31, 2024 for the above-mentioned services; and

WHEREAS, an emergency exists in the usual daily operation of the Department of Technology in that it is immediately necessary to authorize the Director of the Department of Technology to enter into contract with Brown Enterprises LLC for Smartsheet Control Center subscriptions and licenses to facilitate prompt contract execution and related payment for services as the current contract expires on August 31, 2023, thereby preserving the public health, peace, property, safety, and welfare; **NOW, THEREFORE:**

BE IT ORDAINED BY THE COUNCIL OF THE CITY OF COLUMBUS:

SECTION 1. That the Director of the Department of Technology be and is hereby authorized to renew the contract with Brown Enterprises LLC for Smartsheet Control Center subscriptions and licenses, beginning on September 1, 2023 and ending on August 31, 2024 at a cost of up to \$158,529.00

SECTION 2. That the expenditure of up to \$158,529.00 or so much thereof as may be necessary is hereby authorized to be expended from the Department of Technology, Information Services Operating Fund, as follows in the attachment to this ordinance: (see attachment 2142-2023EXP)

SECTION 3. That the City Auditor is authorized to make any accounting changes to revise the funding source for any contract or contract modifications associated with this ordinance.

SECTION 4. That the funds necessary to carry out the purpose of this ordinance are hereby deemed appropriated, and the City Auditor shall establish such accounting codes as necessary.

SECTION 5. That for the reasons stated in the preamble hereto, which is hereby made a part hereof, this ordinance is hereby declared to be an emergency measure and shall take effect and be in force from and after its passage and approval by the Mayor, or ten days after passage if the Mayor neither approves nor vetoes the same.

Legislation Number: 2146-2023

Drafting Date: 7/10/2023

Current Status: Passed

Version: 1

Matter Type: Ordinance

This legislation authorizes the Director of the Department of Development to enter into a grant agreement in an amount up to \$350,000.00 with Columbus Housing Partnership Inc, dba Homeport, in support of the Homeownership fund which will provide targeted down payment assistance and housing counseling services.

Participants may receive up to \$7,500, or 5% of the mortgage amount, whichever is less, in a dollar-for-dollar match to down payment documented in personal savings. This fund will enable at least 120 households to purchase a home. Funding may be used for down payment, closing costs, and/or rate buy-downs. Assistance is forgiven after three years of owner-occupancy. Assistance can be used with any conventional, FHA, VA, or USDA loan. Assistance can also be twinned with other programs, including those offered by the Ohio Housing Finance Agency or Franklin County.

Additionally, Housing counseling services will be offered, providing individualized support on topics like contract negotiation, applying for a loan, lender underwriting criteria, budgeting and mortgage amount calculations, credit repair, closing process, and post-purchase sustainability. Counseling also links applicants to other minority homeownership assistance initiatives, including emerging special purpose credit programs.

Emergency Designation: Emergency action is requested to ensure that Homeport can immediately begin providing targeted down payment assistance and housing counseling services.

Fiscal Impact: Funds are available within the Easton TIF Fund to support this contract.

Contract Compliance: the vendor number is 004842 and expires 3/14/2024.

To authorize the Director of the Department of Development to enter into a grant agreement with Columbus Housing Partnership Inc, dba Homeport, in support of the Homeownership fund which will provide targeted down payment assistance and housing counseling services; to authorize an appropriation and expenditure within the Easton TIF Fund; and to declare an emergency. (\$350,000.00)

WHEREAS, closing Black and minority homeownership gaps through targeted down payment assistance, comprehensive housing counseling, and wrap-around supports for sustainable ownership provides a benefit to the city; and,

WHEREAS, Columbus City Council is committed to assisting with financial support for the homeownership fund, which aims to provide targeted down payment assistance and housing counseling services; and,

WHEREAS, an emergency exists in the usual daily operation of the Department of Development in that it is immediately necessary to authorize the Director to enter into a contract with Columbus Housing Partnership Inc, dba Homeport, to immediately begin providing targeted down payment assistance and housing counseling services on behalf of Columbus residents, all for the immediate preservation of the public health, peace, property, safety and welfare; and **NOW THEREFORE**,

BE IT ORDAINED BY THE COUNCIL OF THE CITY OF COLUMBUS:

SECTION 1: That the Director of the Department of Development is hereby authorized to enter into a grant agreement in an amount up to \$350,000.00 with Columbus Housing Partnership Inc, dba Homeport, in support of their Homeownership fund which will provide targeted down payment assistance and housing counseling services.

SECTION 2: That the Auditor is hereby authorized and directed to appropriate \$350,000.00 to the Department of Development within the Easton TIF Fund, fund 7790, in Capital-06 per the accounting codes in the attachment to this ordinance.

SECTION 3: That per the action authorized by Section 1 of this ordinance, the expenditure of \$350,000.00 or so much thereof as may be needed is hereby authorized in the Easton TIF Fund, fund 7790, per the accounting codes in the attachment to this ordinance.

SECTION 4: That the funds necessary to carry out the purpose of this ordinance are hereby deemed appropriated, and the City Auditor shall establish such accounting codes as necessary.

SECTION 5: That the City Auditor is hereby authorized to transfer the unencumbered balance in a project account to the unallocated balance account within the same fund upon receipt of certification by the Director of the Department administering said project that the project has been completed and the monies are no longer required for said project.

SECTION 6: That the City Auditor is authorized to make any accounting changes to revise the funding source for all contracts or contract modifications associated with this legislation.

SECTION 7: That for reasons stated in the preamble hereto, which is hereby made a part hereof, this Ordinance is declared to be an emergency measure and shall take effect and be in force from and after its passage and approval by the Mayor, or ten days after passage if the Mayor neither approves nor vetoes the same.

Legislation Number: 2147-2023

Drafting Date: 7/10/2023

Version: 1

Current Status: Passed

Matter Type: Ordinance

This ordinance authorizes the Director of the Department of Technology to renew an agreement with

Columbus Fibernet LLC for fiber optic cable maintenance services in the amount of \$82,746.45, with a coverage term period from October 21, 2023 through October 20, 2024 for the CFN fiber duct system, in support of the City's fiber optic infrastructure. The original agreement (EL010409) and (EL011025) was authorized by ordinances 1296-2009, passed October 5, 2009, and 1327-2010, passed October 4, 2010. These ordinances authorized the city to acquire a portion of the conduit system known as Fibernet, which at that time consisted of one point nine inch (1.9") duct with ninety six (96) strand single mode installed fiber. This ordinance authorizes the one-year renewal, authorized by the above-mentioned Ordinance 1296-2009. At the time of purchase, maintenance fees were waived for a period of five years. Starting in 2015, however, contract terms for scheduled annual maintenance (with an annual maintenance fee) was authorized. These terms are as follows:

"Section 9.1 references: "Scheduled Maintenance Seller shall use commercially reasonable methods to maintain the Property in a secure and good condition. Such routine maintenance ("Scheduled Maintenance") shall include, but is not limited to, locating and marking the Property and pumping, venting, air quality testing, and proofing the Property when necessary. Buyer shall pay to Seller for Seller's services under this Section 9.1, an amount equal to \$0.19 (cents) a year per foot of conduit owned by Buyer (the "Maintenance Fee") for the period commencing 5 years from the Closing date and continuing thereafter for a period of 12 months ("Initial Term"). The first 5 years of this contract the fees will be waived. After the Initial Term expires, the Maintenance Fee shall increase annually by the change in CPI. This fee shall continue for so long as Seller is providing Scheduled Maintenance services to Buyer hereunder. Such payments are due up front on the first day of each anniversary of the Closing date."

The aforementioned original agreement was most recently renewed on April 4, 2023, via the passage of Ordinance 1137-2023, authorizing the required annual maintenance for the period of October 21, 2022 through October 20, 2023.

The City fiber optic cabling is in various strand count quantities throughout the City. The above-described services are needed to regularly inspect and maintain these assets, and provide fiber optic cable maintenance services in the event of unforeseen damage to the fiber network. This agreement provides labor, equipment, and materials needed to ensure reliable operation of the City's fiber network.

CONTRACT COMPLIANCE

Vendor: Columbus Fibernet LLC (CFN); F.I.D#/CC#: 31-1762185; City DAX Acct. No. # 005936;
Expiration Date: 8/30/2024

FISCAL IMPACT

In fiscal years 2021 and 2023, \$72,917.54 and \$76,624.18 was expended to renew the Columbus Fibernet LLC contract, respectively. This ordinance authorizes the expenditure of \$82,745.46 to renew the aforementioned contract from October 21, 2023 through October 20, 2024. These funds are budgeted and available in the Department of Technology, Information Services Division, Information Services Operating Fund.

To authorize the Director of the Department of Technology to renew an agreement with Columbus Fibernet, LLC (CFN) for fiber optic cable maintenance services for the CFN fiber duct system in support of the City's fiber optic infrastructure; and to authorize the expenditure of \$82,746.45 from the Department of Technology, Information Services Division, Information Services Operating Fund. (\$82,746.45)

WHEREAS, the City owns fiber optic cabling in various strand count quantities that need to be regularly inspected and maintained; and

WHEREAS, the city entered into a twenty-year agreement (EL010409) and (EL011025), authorized by ordinances 1296-2009, passed October 5, 2009 and 1327-2010, passed October 4, 2010, in which it acquired a portion of the conduit system known as Fibernet; and

WHEREAS, at the time of the aforementioned purchase, maintenance fees were waived for a period of five years but starting in 2015, contract terms for scheduled maintenance and an annual maintenance fee was authorized; and

WHEREAS, it is necessary to authorize the Director of the Department of Technology to renew an agreement with Columbus Fibernet LLC, for fiber optic cable maintenance services for the CFN fiber duct system in

support of the City’s fiber optic infrastructure, in the amount of \$82,746.45 with a coverage term starting October 21, 2023 and ending on October 20, 2024; and

WHEREAS, it is necessary to authorize the Technology Director to renew an agreement with Columbus Fibernet, LLC (CFN) for fiber optic cable maintenance services for the CFN fiber duct system in support of the City’s fiber optic infrastructure so the services of locating and marking the property and pumping, venting, air quality testing, and proofing the Property when necessary will not be interrupted; **NOW, THEREFORE:**

BE IT ORDAINED BY THE COUNCIL OF THE CITY OF COLUMBUS:

SECTION 1: That the Director of the Department of Technology be, and hereby is, authorized to renew an agreement with Columbus Fibernet, LLC (CFN) for fiber optic cable maintenance services for the CFN fiber duct system in support of the City’s fiber optic infrastructure in the amount of \$82,746.45, starting on October 21, 2023 and ending on through October 20, 2024.

SECTION 2: That the expenditure of \$82,746.45 or so much thereof as may be necessary is hereby authorized to be expended as follows in the attachment to this ordinance. **(Please see attachment 2147-2023 EXP):**

SECTION 3: That the funds necessary to carry out the purpose of this ordinance are hereby deemed appropriated, and the City Auditor shall establish such accounting codes as necessary.

SECTION 4: That the City Auditor is authorized to make any accounting changes to revise the funding source for all contracts or contract modifications associated with this ordinance.

SECTION 5. That this ordinance shall take effect and be in force from and after the earliest period allowed by law.

Legislation Number: 2148-2023

Drafting Date: 7/10/2023

Version: 1

Current Status: Passed

Matter Type: Ordinance

Mayor Ginter’s vision for Columbus, America’s Opportunity City, is that every child is ready for kindergarten. Addressing early childhood learning means bringing awareness and resources to a critical learning stage in childhood development. Children who come to school ready to learn are more likely to succeed academically and in life.

To make sure our children are ready for kindergarten, the Department of Education uses different tools and collaborates with certain organizations in the preparation of our children. Ready4Success (R4S), administered by the Crane Center for Early Childhood Research and Policy at the Ohio State University, uses a multi-pronged strategy to support providers in preparing children for Kindergarten success. The goal of the R4S initiative is to improve children’s outcomes and kindergarten readiness. It does so by focusing on the instructional practices of pre-kindergarten teachers.

For the 2023-2024 academic year, the Crane Center staff will also develop and implement Read It Again (RIA), an evidence-based, low-cost instructional supplement designed to promote intentional teaching practices in early childhood education programs serving children from birth to age five. Developing, implementing, and offering RIA to all early childhood providers is aligned with, and is an early strategy of, the Future Ready By Five Strategic Plan driver one: providing development and education supports for all children.

Therefore, the Department of Education requests permission to contract for \$491,000.00 with the Crane Center

for Early Childhood Research and Policy at the Ohio State University to provide this crucial work.

This contract is being awarded pursuant to Columbus City Code Section 329.30, which allows for the City to negotiate not-for-profit service contracts. The Department of Education chose the Crane Center for Early Childhood Research and Policy at The Ohio State University because there is no employee expertly positioned to do this work in the city. For the past five school years, the Office of Education has contracted and partnered with the Crane Center to expand the Early Start Columbus Program and we see that there is no other entity with the experience and expertise for the program.

FISCAL IMPACT: Funding for this contract (\$491,000.00) is available within the 2023 Office of Education General Fund budget.

To authorize the Director of the Office of Education to enter into a contract with the Crane Center for Early Childhood Research and Policy at The Ohio State University to implement Ready4Success, a screening and improvement strategy, and Read It Again, Read it Again - Math, and to provide mid-year student assessment; and to authorize the expenditure of \$491,000.00 from the General Fund. (\$491,000.00)

WHEREAS, Mayor Ginther's vision for Columbus, America's Opportunity City, is that every child is ready for kindergarten; and

WHEREAS, to make sure our children are ready for kindergarten, the Department of Education uses different tools and collaborates with certain organizations; and

WHEREAS, Ready4Success uses a multi-pronged strategy to support providers in preparing children for Kindergarten success; and

WHEREAS, Ready4Success improves children's outcomes by focusing on the instructional practices of teachers; and

WHEREAS, Read It Again and Read it Again Math are early strategy of the Future Ready By Five Strategic Plan; and

WHEREAS, a mid-year student assessment will help in identifying struggling students and provide to them specialized programming; and

WHEREAS, this contract is being awarded pursuant to City Code Chapter 329.30, which allows for the City to negotiate not-for-profit service contracts and there is no city employee expertly positioned to do this work within the city; and

WHEREAS, it has become necessary in the usual daily operation of the Office of Education to authorize the Director to enter into contract with the Crane Center for Early Childhood Research and Policy at The Ohio State University for the public health, safety, and welfare; **NOW, THEREFORE:**

BE IT ORDAINED BY THE COUNCIL OF THE CITY OF COLUMBUS:

SECTION 1. That the Director of the Department of Education is authorized to enter into a contract with the Crane Center for Early Childhood Research and Policy at the Ohio State University for the implementation of the Ready4Success and Read It Again programs.

SECTION 2. That the expenditure of \$491,000.00 or so much thereof as may be needed, is hereby

authorized to be expended from the General Fund as follows:

Div.: 40-06 | **Fund:** 1000 | **SubFund:** 100010 | **Obj. Class:** 03 | **Main Acct:** 63050 | **Program:** ED001 |
Amount: \$491,000.00

SECTION 3. That the funds necessary to carry out the purpose of this ordinance are hereby deemed appropriated, and the City Auditor shall establish such accounting codes as necessary.

SECTION 4. That the City Auditor is authorized to make any accounting changes to revise the funding source for all contracts or contract modifications associated with this legislation.

SECTION 5. That this ordinance shall take effect and be in force from and after the earliest period allowed by law.

Legislation Number: 2150-2023

Drafting Date: 7/10/2023

Current Status: Passed

Version: 1

Matter Type: Ordinance

BACKGROUND: This legislation authorizes the Director of the Department of Finance and Management to modify a contract with Booth Management Consulting, LLC to expand subrecipient monitoring professional services, as well as provide technical assistance, and training. The City of Columbus receives millions of dollars annually from the United States Government in the form of federal grants. The grants fund various programs and projects. Periodically, the City partners with third parties to execute program or project scopes. These third parties are considered subrecipients of federal funds and execute subaward agreements with the City. When the City issues a subaward to a subrecipient to carry out part of a federal program, the City is required by Uniform Guidance 2 CFR Part 200.332 to ensure subrecipients comply with applicable federal laws and regulations and with the provisions of each subaward agreement.

The City of Columbus utilized a Request for Proposals (RFP) process to identify and assess qualified Certified Public Accounting (CPA) firms to provide subrecipient monitoring professional services. Proposals were submitted in response to RFQ020261 in accordance with the relevant provisions of Chapter 329 of the Columbus City Codes, and Booth Management Consulting, LLC, received the highest overall score from the RFP committee. Ordinance 0197-2022 authorized the Director of Finance and Management to enter into contract with Booth Management Consulting for the period March 9, 2022 to January 23, 2023, with the option to extend on a year to year basis for up to an additional three years.

Ordinance 2138-2022 authorized the Department of Finance and Management to modify the existing contract. Ordinance 0718-2023 authorized the Department of Finance and Management to modify and extend the contract to January 23, 2024. The Department of Finance and Management is seeking authority to modify and increase the amount of the contract in order to cover additional services associated with subrecipient monitoring and technical assistance.

Booth Management Consulting, LLC; Contract Compliance CC# 040075 Expires 11/08/2023

Fiscal Impact: This contract is eligible for and will be funded by State Local Fiscal Recovery Fund, Emergency Rental Assistance Fund, and the Community Development Block Grant Fund.

Emergency action is requested so that the existing contract can be modified immediately and subrecipient monitoring, technical assistance, and training can continue without delay due to the timing of federal reporting

requirements.

To authorize the Director of the Department of Finance and Management to modify a contract with Booth Management Consulting, LLC, to provide subrecipient monitoring, technical assistance, and training related to the City's administration of Federal Grant Awards; to authorize the appropriation and expenditure of \$8,841.25 from the Community Development Block Grant Fund; to authorize the transfer and expenditure of \$28,780.00 from the Emergency Rental Assistance fund and \$269,575.00 from the Recovery Fund; and to declare an emergency (\$307,196.25).

WHEREAS, the City has a need for subrecipient monitoring, technical assistance, and training related to the City's administration of Federal Grant Awards; and

WHEREAS, the City of Columbus, utilized a Request for Proposals (RFP) process to identify and assess qualified firms; and

WHEREAS, proposals were submitted in response to RFQ020261 in accordance with the relevant provisions of Chapter 329 of the Columbus City Codes pertaining to professional service contracts, and Booth Management Consulting, LLC received the highest overall score from the RFP committee; and

WHEREAS, it is necessary to modify the existing contract with Booth Management Consulting, LLC to expand subrecipient monitoring professional services, as well as technical assistance, and training; and

WHEREAS, it is necessary to authorize the appropriation and expenditure of \$8,841.25 from the Community Development Block Grant Fund (2248); and

WHEREAS, it is necessary to authorize the transfer and expenditure of \$28,780.00 from the Emergency Rental Assistance Fund (2208) and \$269,575.00 from the Recovery Fund (2209); and

WHEREAS, an emergency exists in the usual daily operation of the Department of Finance and Management in that it is immediately necessary to authorize the Director to modify an existing contract with Booth Management Consulting, LLC to provide subrecipient monitoring, technical assistance, and training so that such activities can continue without delay due to the timing of federal reporting requirements, for the preservation of the public health, peace, property, safety, and welfare; and **NOW THEREFORE**,

BE IT ORDAINED BY THE COUNCIL OF THE CITY OF COLUMBUS:

SECTION 1. That the Director of the Department of Finance and Management is hereby authorized to modify an existing contract with Booth Management Consulting, LLC to provide subrecipient monitoring, technical assistance, and training services related to Federal Grant Awards.

SECTION 2. That the expenditure of up to \$307,196.25, or so much thereof as may be needed pursuant to the action authorized in SECTION 1, is hereby authorized, in Object Class 03 - Contractual Services, per the accounting codes in the attachment to this ordinance.

SECTION 3. That the funds necessary to carry out the purpose of this ordinance are hereby deemed appropriated, and the City Auditor shall establish such accounting codes as necessary.

SECTION 4. That the monies appropriated in the foregoing Sections shall be paid upon the order of the Department of Finance and Management, and that no order shall be drawn or money paid except by voucher, the form of which shall be approved by the City Auditor.

SECTION 5. That the City Auditor is authorized to make any accounting changes to revise the funding source for all contracts or contract modifications associated with this ordinance.

SECTION 6. That for the reasons stated in the preamble hereto, this ordinance is hereby declared to be an emergency measure and shall take effect and be in force from and after its passage and approval by the Mayor, or ten days after passage if the Mayor neither approves nor vetoes the same.

Legislation Number: 2151-2023

Drafting Date: 7/10/2023

Current Status: Passed

Version: 1

Matter Type: Ordinance

BACKGROUND: This legislation authorizes the Finance and Management Director to establish a Universal Term Contract (UTC) for the option to purchase Oils, Greases, and Fluids with Glockner Oil Company, Inc. The Division of Fleet Management is the primary user for Oils, Greases, and Fluids. Oils, Greases, and Fluids are used to maintain City vehicles and equipment. The term of the proposed option contract would be approximately two (2) years, expiring October 31, 2025, with the option to renew for one (1) additional year. The Purchasing Office opened formal bids on July 6, 2023. In addition, the expenditure of \$1.00 is hereby authorized from General Budget Reservation BRPO002253.

The Purchasing Office advertised and solicited competitive bids in accordance with the relevant provisions of Section 329 relating to competitive bidding (Request for Quotation No. RFQ025141). Two bids were received.

The Purchasing Office is recommending award to the overall lowest, responsive, responsible and best bidder as follows:

Glockner Oil Company, Inc., CC# 004587 expires 7/7/2025, All Items, \$1.00
Total Estimated Annual Expenditure: \$400,000.00, Division of Fleet Management, the primary user

The company is not debarred according to the Excluded Party Listing System of the Federal Government or prohibited from being awarded a contract according to the Auditor of State Unresolved Findings for Recovery Certified Search.

FISCAL IMPACT: The expenditure of \$1.00 is hereby authorized from General Budget Reservation BRPO002253. City Agencies will be required to obtain approval to expend from their own appropriations for their estimated annual expenditures.

To authorize the Finance and Management Director to enter into a Universal Term Contract for the option to purchase Oils, Greases, and Fluids with Glockner Oil Company, Inc.; and to authorize the expenditure of \$1.00. (\$1.00)

WHEREAS, the Oils, Greases, and Fluids UTC will provide for the purchase of Oils, Greases and Fluids used to maintain City vehicles and equipment; and,

WHEREAS, the Purchasing Office advertised and solicited formal bids on July 6, 2023 and selected the overall lowest, responsive, responsible and best bidder; and

WHEREAS, it has become necessary in the daily operation of the Department of Finance and Management, Division of Fleet Management to authorize the Director of Finance and Management to enter into a Universal Term Contract for the option to purchase Oils, Greases, and Fluids; **now, therefore**

BE IT ORDAINED BY THE COUNCIL OF THE CITY OF COLUMBUS:

SECTION 1. That the Finance and Management Director is hereby authorized to enter into the following Universal Term Contract for the option to purchase Oils, Greases, and Fluids in accordance with Request for Quotation RFQ025141 for a term of approximately two (2) years, expiring October 31, 2025, with the option to renew for one (1) additional year, as follows:

Glockner Oil Company, Inc., All Items, \$1.00

SECTION 2. That the expenditure of \$1.00 is hereby authorized from General Budget Reservation BRPO002253 of this ordinance to pay the cost thereof.

SECTION 3. That the funds necessary to carry out the purpose of this ordinance are hereby deemed appropriated, and the City Auditor shall establish such accounting codes as necessary.

SECTION 4. That this ordinance shall take effect and be in force from and after the earliest period allowed by law.

Legislation Number: 2155-2023

Drafting Date: 7/10/2023

Current Status: Passed

Version: 1

Matter Type: Ordinance

BACKGROUND: This legislation authorizes the Finance and Management Director to establish Universal Term Contracts (UTCs) for the option to purchase Aftermarket Truck Parts with Rush Truck Centers of Ohio, Inc. and Fyda Freightliner Columbus, Inc. The Division of Fleet Management is the primary user for Aftermarket Truck Parts. Aftermarket Truck Parts are used to repair and maintain City commercial vehicles. The term of the proposed option contracts would be approximately two (2) years, expiring October 31, 2025, with the option to renew for one (1) additional year. The Purchasing Office opened formal bids on July 6, 2023. In addition, the expenditure of \$2.00 is hereby authorized from General Budget Reservation BRPO002253.

The Purchasing Office advertised and solicited competitive bids in accordance with the relevant provisions of Section 329 relating to competitive bidding (Request for Quotation No. RFQ025150). Three (3) bids were received.

The Purchasing Office is recommending award to the overall lowest, responsive, responsible and best bidders as follows:

Rush Truck Centers of Ohio, Inc., CC# 008512 expires 7/6/2025, All Items, \$1.00

Fyda Freightliner Columbus, Inc., CC# 004301 expires 4/14/2025, All Items, \$1.00

Total Estimated Annual Expenditure: \$175,000.00, Division of Fleet Management, the primary user

The companies are not debarred according to the Excluded Party Listing System of the Federal Government or

prohibited from being awarded a contract according to the Auditor of State Unresolved Findings for Recovery Certified Search.

FISCAL IMPACT: The expenditure of \$2.00 is hereby authorized from General Budget Reservation BRPO002253. City Agencies will be required to obtain approval to expend from their own appropriations for their estimated annual expenditures.

To authorize the Finance and Management Director to enter into Universal Term Contracts for the option to purchase Aftermarket Truck Parts with Rush Truck Centers of Ohio, Inc. and Fyda Freightliner Columbus, Inc.; and to authorize the expenditure of \$2.00. (\$2.00)

WHEREAS, the Aftermarket Truck Parts UTCs will provide for the purchase of Aftermarket Truck Parts used to repair and maintain City commercial vehicles; and,

WHEREAS, the Purchasing Office advertised and solicited formal bids on July 6, 2023 and selected the overall lowest, responsive, responsible and best bidders; and

WHEREAS, it has become necessary in the daily operation of the Department of Finance and Management, Division of Fleet Management, to authorize the Director of Finance and Management to enter into a Universal Term Contract for the option to purchase Aftermarket Truck Parts; **now, therefore**

BE IT ORDAINED BY THE COUNCIL OF THE CITY OF COLUMBUS:

SECTION 1. That the Finance and Management Director is hereby authorized to enter into the following Universal Term Contracts for the option to purchase Aftermarket Truck Parts in accordance with Request for Quotation RFQ025150 for a term of approximately two (2) years, expiring October 31, 2025, with the option to renew for one (1) additional year, as follows:

Rush Truck Centers of Ohio, Inc., All Items, \$1.00
Fyda Freightliner Columbus, Inc., All Items, \$1.00

SECTION 2. That the expenditure of \$2.00 is hereby authorized from General Budget Reservation BRPO002253 of this ordinance to pay the cost thereof.

SECTION 3. That the funds necessary to carry out the purpose of this ordinance are hereby deemed appropriated, and the City Auditor shall establish such accounting codes as necessary.

SECTION 4. That this ordinance shall take effect and be in force from and after the earliest period allowed by law.

Legislation Number: 2156-2023

Drafting Date: 7/10/2023

Version: 1

Current Status: Passed

Matter Type: Ordinance

This ordinance modifies the service agreement with Columbus Next Generation Corporation originally authorized by ordinance 1268-2021 and modified by ordinances 3315-2021 and 2279-2022 for administration

of the program providing exterior home repair to address code violations.

Columbus Next Generation (“NextGen”) has been working with The City of Columbus, Office of the City Attorney, and the Franklin County Environmental Courts to assist homeowners throughout the city that are elderly and/or disabled to repair code violations on their homes that are in the court systems (and have been) since prior to the COVID-19 pandemic. Repairs range from roof repair to new roofs, gutters, painting, sewer line work, porch/foundation work, cutting down dead trees, overgrown high weeds, branches and grass. The homeowners do not have the financial means or physical ability to do such repairs. Their incomes are very limited. In July 2021, City Attorney Zack Klein’s office requested and received grant money in the amount of \$100,000 to start the Home Repair Program. NextGen works with local contractors and encourages minority participation as much as possible. All contractors are licensed, bonded, have BWC insurance and are registered with the City of Columbus as a contractor (in order to pull necessary permits, if needed, for repairs). Once repairs are complete, NextGen contacts the City Code Officer that referred properties to the court system to make sure the repairs meet the requirements to close out the current code violations.

This ordinance authorizes an extension of the original agreement through December 31, 2024, and increases the available funding by \$500,000.00 from the general fund.

Columbus Next Generation Corporation, FID: 46-2621229 CC#: CC008637, expires 5/30/2025

Fiscal Impact: Funding is available within the general fund.

Emergency action is requested in order to avoid any disruption in the exterior home repair program. To authorize the City Attorney to modify an existing contract with Columbus Next Generation Corporation; to authorize an appropriation and expenditure within the general fund; and to declare an emergency. (\$500,000.00)

WHEREAS, Columbus Next Generation has been working with the City of Columbus Office of the City Attorney and the Franklin County Environmental Courts to assist homeowners throughout the city that are elderly and/or disabled to repair code violations on their homes; and

WHEREAS, repairs range from roof repair to new roofs, gutters, painting, sewer line work, porch/foundation work, cutting down dead trees, overgrown high weeds, branches and grass; and

WHEREAS, the homeowners do not have the financial means or physical ability to do such repairs; and

WHEREAS, an emergency exists in the usual daily operation of the City Attorney's Office that it is immediately necessary to authorize a contract modification with Columbus NextGen in order to avoid any disruption in the exterior home repair program, for the preservation of the health, safety, and welfare of residents; **now, therefore,**

BE IT ORDAINED BY THE COUNCIL OF THE CITY OF COLUMBUS:

SECTION 1. That the City Attorney is hereby authorized to modify an existing contract with Columbus Next Generation Corporation, originally authorized by ordinance 1268-2021, by extending the expiration date to December 31, 2024 and by adding \$500,000.00 of available resources.

SECTION 2. That the Auditor is hereby authorized and directed to appropriate \$500,000.00 within the

Neighborhood Initiatives subfund per the accounting codes in the attachment to this ordinance.

SECTION 3. That per the action authorized by Section 1 of this ordinance, the expenditure of \$500,000.00 within the general fund, fund 1000, subfund 100018, is hereby authorized per the accounting codes in the attachment to this ordinance.

SECTION 4. That the funds necessary to carry out the purpose of this ordinance are hereby deemed appropriated, and the City Auditor shall establish such accounting codes as necessary.

SECTION 5. That the City Auditor is authorized to make any accounting changes to revise the funding source for all contracts or contract modifications associated with this ordinance.

SECTION 6. That for the reasons stated in the preamble hereto, which is hereby made a part hereof, this ordinance is hereby declared to be an emergency measure and shall take effect and be in force from and after its passage and approval by the Mayor, or ten days after passage if the Mayor neither approves nor vetoes the same.

Legislation Number: 2157-2023

Drafting Date: 7/10/2023

Version: 1

Current Status: Passed

Matter Type: Ordinance

1. BACKGROUND

This ordinance provides \$300,000.00 to prevent construction inspection and administration deficits for capital improvement projects within the Department of Public Service.

Construction inspection and administration funding is normally approved by Council when the construction costs are legislated for the project and the funds are then available throughout the time it takes to complete the project. Inspection and administration costs are estimated by taking a percentage of the construction cost. Occasionally the funds set-up for this cost are insufficient to last through project completion. Projects may require additional construction inspection and administration funds for varying reasons including project unforeseen conditions, weather, construction change orders, etc. It is then necessary to request additional funding for the remaining inspection costs.

The funds requested by this ordinance are typically used to supplement inspection and administration costs on projects that would have incurred a small deficit without the availability of these funds. The Department of Public Service usually performs an assessment of the remaining funding for inspection and administration for all projects two times a year. Separate legislation is submitted requesting Council approval for additional construction inspection and administration funds for projects that are projected to run large deficits before the completion of construction.

2. FISCAL IMPACT

This is a budgeted expense in the amount of \$300,000.00 in the Department of Public Service's 2023 Capital Improvement Budget, Fund 7704, the Streets and Highways Bond Fund, Project 530161-100071 (Roadway Improvements - Miscellaneous Construction Inspection). Funds are appropriated.

To authorize the establishment of an Auditor's Certificate for construction inspection and administration fees; and to authorize the expenditure of up to \$300,000.00 from the Streets and Highways Bond Fund for the

purpose of providing sufficient funding for construction inspection and administration services on Public Service projects. (\$300,000.00)

WHEREAS, capital improvement projects undertaken by the Department of Public Service within the City of Columbus generally include an inspection and administration component; and

WHEREAS, the amount encumbered for inspection and administration is ordinarily an estimate based on the project's construction expense; and

WHEREAS, the actual amounts charged are subject to many variables including but not limited to unforeseen conditions, weather, construction change orders, and so on; and

WHEREAS, it is necessary to establish an Auditor's Certificate for projects that exceed the funds originally set-up in legislation for construction inspection and administration; **now, therefore**

BE IT ORDAINED BY THE COUNCIL OF THE CITY OF COLUMBUS:

SECTION 1. That the City Auditor is authorized to establish an Auditor's Certificate totaling \$300,000.00 for the payment of construction inspection and administration fees.

SECTION 2. That the expenditure of \$300,000.00, or so much thereof as may be needed, is hereby authorized in Fund 7704 (Streets and Highways Bond Fund), Dept-Div 5912 (Design and Construction), Project P530161-100071 (Roadway Improvements - Miscellaneous Construction Inspection), in Object Class 06 (Capital Outlay) per the accounting codes in the attachment to this ordinance.

SECTION 3. That the funds necessary to carry out the purpose of this ordinance are hereby deemed appropriated, and the City Auditor shall establish such accounting codes as necessary.

SECTION 4. That the City Auditor is authorized to make any accounting changes to revise the funding source for all contracts or contract modifications associated with this ordinance

SECTION 5. That the City Auditor is hereby authorized to transfer the unencumbered balance in a project account to the unallocated balance account within the same fund upon receipt of certification by the Director of the Department administering said project that the project has been completed and the monies are no longer required for said project.

SECTION 6. That this ordinance shall take effect and be in force from and after the earliest period allowed by law.

Legislation Number: 2158-2023

Drafting Date: 7/10/2023

Version: 1

Current Status: Passed

Matter Type: Ordinance

Background:

The Central Ohio Area Agency on Aging of the Recreation and Parks Department was awarded federal American Rescue Plan Act (ARPA) funds from the Ohio Department of Aging for the continuation of services to older adults in the Central Ohio area, including Delaware, Fairfield, Fayette, Franklin, Licking, Madison, Pickaway and Union Counties.

This ordinance authorizes the Director of Recreation and Parks to enter into a non-profit service contract with The Gladden Community House for the provision of supportive and home modification services for the period July 1, 2023, through September 30, 2024.

Approximately 100 individuals are expected to be served.

BID INFORMATION:

The Central Ohio Area Agency on Aging selected service providers in accordance with the procedures set forth in Columbus City Code, Section 329. COAAA released a Notice of Funding Availability (NOFA) for senior community services on April 10, 2023 and hosted a virtual bidder's conference on April 14, 2023. Interested service providers submitted proposals on May 5, 2023. Proposals were competitively reviewed by COAAA employees from May 5 to May 26, 2023. Based on the evaluation of the 121 service applications received, a determination was made by COAAA's Administrator to enter into contract with The Gladden Community House and 32 other agencies, whose contracts were authorized by Ordinance 1710-2023 on July 10, 2023. COAAA's Advisory Council approved the recommendations to fund the identified service providers. This contract is awarded pursuant to City Code Sections 329 relating to non-profit service contracts, such that the services provided by The Gladden Community House cannot be provided by existing city employees. COAAA employees do not have the expertise to perform supportive and home modification services.

Emergency Justification:

Emergency action is requested in order to have the contract in place by July 1, 2023, or as soon as possible, as stipulated in the grant requirements, so there is no delay in services to older adults.

Fiscal Impact: \$60,000.00 is required and budgeted from the Recreation and Parks Grant Fund to meet the financial obligation of this contract.

To authorize and direct the Director of Recreation and Parks to enter into a non-profit service contract with The Gladden Community House to provide supportive and home modification services to older adults in Central Ohio for the period of July 1, 2023, to September 30, 2024; to authorize the expenditure of \$60,000.00 from the Recreation and Parks Grant Fund; and to declare an emergency. (\$60,000.00)

WHEREAS, American Rescue Plan Act funding to enter into a non-profit contract with The Gladden Community House to provide supportive and home modification services to older adults in Central Ohio for the period of July 1, 2023, to September 30, 2024, was made available to the Central Ohio Area Agency on Aging from the Ohio Department of Aging; and

WHEREAS, it is necessary to authorize the Director of the Department of Recreation and Parks to enter into a non-profit contract with The Gladden Community House to provide supportive and home modification services to older adults in Central Ohio for the period of July 1, 2023, to September 30, 2024; and

WHEREAS, expenditure of American Rescue Plan Act funding is necessary to help expand such services for older Americans that are needed as a result of the COVID-19 public health emergency; and

WHEREAS, such expenditure of funds has not been previously accounted for in the 2023 Budget; and

WHEREAS, an emergency exists in the usual daily operation of the Recreation and Parks Department in that it is immediately necessary to authorize the Director to enter into said contract to avoid delay of services to older adults, all for the immediate preservation of the public health, peace, property, safety, and welfare; and

NOW THEREFORE,

BE IT ORDAINED BY THE COUNCIL OF THE CITY OF COLUMBUS:

SECTION 1. That the Director of Recreation and Parks is authorized and directed to enter into a non-profit

contract with The Gladden Community House to provide supportive and home modification services to older adults in Central Ohio for the period of July 1, 2023, to September 30, 2024.

SECTION 2. That this contract is awarded pursuant to City Code Sections 329 relating to non-profit service contracts. Pursuant to City Code Section 329, the services provided by the contracting agencies cannot be provided by existing city employees, as COAAA employees do not have the expertise to perform supportive and home modification services.

SECTION 3. That to pay the cost of said contract, the expenditure of \$60,000.00 or so much thereof as may be necessary, is hereby authorized from and within the Recreation and Parks Grant Fund No. 2286, per the accounting codes in the attachment to this ordinance.

SECTION 4. At the end of the grant period, any repayment of unencumbered balances required by the grantor is hereby authorized, and any unused City match monies may be transferred back to the City fund from which they originated in accordance with all applicable grant agreements.

SECTION 5. That the City Auditor is authorized to make any accounting changes to revise the funding source for all contracts or contract modifications associated with this legislation.

SECTION 6. That for the reasons stated in the preamble hereto, which is hereby made a part thereof, this Ordinance is hereby declared to be an emergency measure and shall take effect and be in force from and after its passage and approval by the Mayor, or 10 days after passage if the Mayor neither approves nor vetoes the same.

Legislation Number: 2167-2023

Drafting Date: 7/11/2023

Version: 1

Current Status: Passed

Matter Type: Ordinance

BACKGROUND: The policing of First Amendment crowd events has been a major driver of recent challenges to police legitimacy both in Columbus and nationwide. In response to the civil unrest of 2020, police agencies across the US have therefore been re-evaluating their crowd management strategies. Accordingly, the Columbus Division of Police has developed 'ENABLE Columbus' which is a partnership project between Crowd and Conflict Management Ltd (CCM Ltd), the Columbus Division of Police (CDP), The Ohio State University (OSU), Keele University, and the City of Columbus.

ENABLE Columbus aims to utilize this knowledge production partnership to embed and enhance the CDP's new science led approach to crowd policing, develop new research expertise based at OSU, gather primary data on the effectiveness and limitations of the new approach, use this evidence to further enhance CDP's crowd management strategies, foster dialogue between police and demonstrators, help safeguard First Amendment rights, and position the City of Columbus as providing the nationally leading approach to crowd management policing.

This legislation authorizes the Director of the Department of Public Safety to enter into a contract with Crowd and Conflict Management Ltd. for the implementation of phase one of the 'ENABLE Columbus' project.

The purpose of phase one is to undertake preliminary consultancy, training and research that will constitute the development work that is necessary to undertake phase two of the project. Both phases are designed to position

Columbus as a national leader in evidence-based crowd management, while also establishing the John Glenn College of Public Affairs at OSU as a globally renowned research center in this field.

Professor Stott is the Director of CCM Ltd and is the world-leading expert in crowd psychology and policing. He has worked with governments and police forces internationally and is at the forefront globally of developing new science-based approaches to crowd management utilizing specialized units of Dialogue Police.

The CDP has been working with CCM Ltd to develop new ways of policing crowds. Consequently, the CDP has developed a new Police Dialogue Unit which focuses on building positive relationships with protesters to facilitate peaceful demonstrations and protect First Amendment rights. CDP's groundbreaking policing approach in the US draws directly on the principles of crowd psychology developed by Professor Stott, taking its inspiration from similar research-led initiatives he has led in Europe.

The CDP Dialogue Unit has been operational since October 2022 and is now the primary tactic of the agency's new science-led operational response to First Amendment events. Their mission is to facilitate the freedom of expression by building community partnerships, enhancing two-way communication and police legitimacy, improving problem-solving capacity, augmenting command decision making, and deescalating tensions.

Preliminary deployments of the new unit indicate the new approach is likely to prove highly beneficial; however, more work is required to evaluate, embed, and expand the approach.

ENABLE Columbus is a two-stage research, consultancy and training project that aims to establish a crowd policing research capacity at OSU's John Glenn College, solidify the presence of a Dialogue Unit within the CPD's crowd management response, and foster a collaborative knowledge-sharing partnership nationally. ENABLE Columbus is designed to establish the City of Columbus and OSU as providing the leading US 'best practice' model for the research-based policing of crowd events and, in so doing, support the export of the CDP model into the broader US context.

The project will facilitate collaboration with various stakeholders including community groups, police oversight agencies, police agencies, the Department of Justice, research centers and higher education institutes as well as City authorities.

Given the complexities involved, and importance of the work, there is a pressing requirement to begin the project as quickly as possible. This contract is to implement phase one which is designed to allow the project to assist CDP in embedding and expanding the new Dialogue Unit locally. Phase one will help support effective interoperability with other agencies, undertake pilot work to develop the necessary methodologies, provide training, develop a formal relationship between OSU, CDP, and other Universities, develop the contracts, agreements, and approvals necessary to advance the project to phase two.

Fiscal Impact: This legislation authorizes the expenditure of \$94,200.00 from the General Fund with Crowd and Conflict Management to implement Phase one of ENABLE Columbus: a science-based approach to policing crowd events. Funding is available in Public Safety's 2023 General Fund Budget for this contract.

Emergency Action: There is a pressing need to begin the project as quickly as possible given the complexities and importance of the work involved. It is requested that a contract can be entered into immediately so that project activities can begin without delay.

To authorize the Director of the Department of Public Safety to enter into a contract with Crowd and Conflict Management Ltd. to implement the first phase of "ENABLE Columbus," a project that aims to develop

research expertise and enhance crowd management strategies, foster dialogue between police and demonstrators and safeguard First Amendment rights in the City of Columbus; to authorize the expenditure of \$94,200.00 from the General Fund; to waive the competitive bidding provisions of the Columbus City Codes; and to declare an emergency. (\$94,200.00)

WHEREAS, the City has a need to implement "ENABLE Columbus" by building a science-based approach to policing crowd events in Columbus; and,

WHEREAS, this initiative is designed to position the City of Columbus and The Ohio State University at the forefront within the US with respect to building a 'best practice' model for research-based policing of crowd events; and,

WHEREAS, a waiver of the competitive bidding provisions of the Columbus City Code is necessary as Professor Stott of Crowd and Conflict Management Ltd is uniquely well-suited to serve as consultant to Columbus' law enforcement and community partners in their implementation efforts; and,

WHEREAS, an emergency exists in the usual daily operation of the Department of Public Safety in that it is immediately necessary to authorize the Director to enter into contract with Crowd and Conflict Management Ltd to implement a science-based approach to policing crowd events and help CDP re-evaluate their crowd management strategies without delay due to the complexities and importance of work involved, for the preservation of the public health, peace, property, safety, and welfare; **NOW, THEREFORE**

BE IT ORDAINED BY THE COUNCIL OF THE CITY OF COLUMBUS:

SECTION 1. That the Director of the Department of Public Safety is hereby authorized to enter into contract with Crowd and Conflict Management Ltd to help the Division of Police to implement the first phase of a science-based approach to policing crowd events in the City of Columbus.

SECTION 2. That this Council finds it is in the best interests of the City to waive the competitive bidding provisions of Chapter 329 of the Columbus City Code to enter into this contract, and hereby waives such provision.

SECTION 3. That the expenditure of up to \$94,200.00, or so much thereof as may be needed pursuant to the action authorized in SECTION 1, is hereby authorized in the General Fund 1000, in Object Class 03 - Contractual Services, per the accounting codes in the attachment to this ordinance.

SECTION 4. That the funds necessary to carry out the purpose of this ordinance are hereby deemed appropriated, and the City Auditor shall establish such accounting codes as necessary.

SECTION 5. That the monies appropriated in the foregoing sections shall be paid upon the order of the Director of the Department of Public Safety, and that no order shall be drawn or money paid except by voucher, the form of which shall be approved by the City Auditor.

SECTION 6. That the City Auditor is authorized to make any accounting changes to revise the funding source for all contracts or contract modifications associated with this ordinance.

SECTION 7. That for the reasons stated in the preamble hereto, which is hereby made a part thereof, this ordinance is hereby declared to be an emergency measure and shall take effect and be in force from and after its passage and approval by the Mayor, or ten days after passage if the Mayor neither approves nor vetoes the

same.

Legislation Number: 2171-2023

Drafting Date: 7/11/2023

Version: 1

Current Status: Passed

Matter Type: Ordinance

BACKGROUND:

This ordinance approves the acceptance of certain territory (AN23-011) by the city of Columbus. The Ohio Revised Code stipulates that to be effective, City acceptance must take place a minimum of 60 days from the receipt by the City Clerk of the approval notice from the county. If City Council does not accept the ordinance within 120 days of its first consideration, the annexation will be considered rejected. This petition was filed with Franklin County on March 28, 2023. City Council approved a service ordinance addressing the site on April 17, 2023. Franklin County approved the annexation on May 2, 2023 and the City Clerk received notice on May 9, 2023.

FISCAL IMPACT:

Provision of municipal services does represent cost to the City; however, the annexation of land also has the potential to create revenue to the City.

To accept the application (AN23-011) of Bachman Farm Ltd. for the annexation of certain territory containing 63.8± acres in Madison Township.

WHEREAS, a petition for the annexation of certain territory in Madison Township was filed on behalf of Bachman Farm Ltd. on March 28, 2023; and

WHEREAS, the petition was considered and approved by the Franklin County Board of Commissioners at a hearing on May 2, 2023; and

WHEREAS, on May 9, 2023, the City Clerk received from Franklin County a certified copy of the resolution addressing the petition; and

WHEREAS, sixty days have now elapsed since receipt of the resolution in accordance with the provisions of the Ohio Revised Code; and

WHEREAS, it is in the best interest of the city of Columbus to accept the annexation of the territory addressed by the petition; **now, therefore,**

BE IT ORDAINED BY THE COUNCIL OF THE CITY OF COLUMBUS

SECTION 1. That the annexation proposed by Bachman Farm Ltd. in a petition filed with the Franklin County Board of Commissioners on March 28, 2023 and subsequently approved by the Board on May 2, 2023 is hereby accepted and said territory is hereby annexed to the city of Columbus. Said territory is described as follows:

Situated in the State of Ohio, County of Franklin, Township of Madison, in the northwest quarter of Section 14, Township 11, Range 21, Congress Lands, being part of that 64.743 acre tract of land conveyed to Bachman Farm, Ltd. by deed of record in Instrument Number 202303220027313 (all references are to the records of the Recorder's Office, Franklin County, Ohio) and more particularly bounded and described as follows:

Beginning, for reference, at the centerline intersection of Winchester Pike (60' wide, see Franklin County right of way plans for S.H. 49, dated 1932) and Bachman Road (32' wide, created by Madison Township Resolution/ Agreement in 1905), at the center of said Section 14;

Thence North 85° 37' 16" West, with the common line to the southwest quarter and the northwest quarter of said Section 14, and with the centerline of said Bachman Road a distance of 84.78 feet to a point in the westerly line of that 6.326 acre tract conveyed to Bachman Farm, Ltd. by deed of record in Instrument Number 202303220027313;

Thence North 40° 34' 15" West, with said westerly line, a distance of 22.61 feet to a point in the northerly right of way line of said Bachman Road, the TRUE POINT OF BEGINNING for this description;

Thence North 85° 37' 16" West, with said northerly right of way line, a distance of 2429.17 feet to a point in the easterly line of the remainder of that 96.409 acre tract conveyed to Bachman Farm, Ltd. by deed of record in Instrument Number 200612130247748;

Thence North 04° 23' 01" East, with the easterly line of said remainder tract, a distance of 254.00 feet to the northeasterly corner thereof;

Thence North 85° 37' 16" West, with the northerly line of said remainder tract, a distance of 150.00 feet to a point in the common line of the northeast quarter of Section 15 and the northwest quarter of said Section 14, the easterly line of that 92.484 acre tract conveyed to ABL Group Ltd. by deed of record in Instrument Number 200211070283903, in the existing City of Columbus corporation line, as established by Ordinance Number 1509-00, of record in Instrument Number 200009130184750;

Thence North 04° 23' 01" East, with said common line, said easterly line, and said corporation line, a distance of 1135.41 feet to the southeasterly corner of that 3.5 acre tract conveyed to Milton R. Hinkle and Carol M. Hinkle by deed of record in Instrument Number 200206120146263;

Thence North 04° 41' 49" East, with said common line and the easterly line of said 3.5 acre tract, a distance of 315.07 feet to the southwesterly corner of that 0.998 acre tract conveyed as Parcel I to Robert R. Hinkle and Georgina Marie Hinkle by deed of record in Instrument Number 201808220113201;

Thence South 85° 31' 19" East, with the southerly line of said Parcel I, the southerly line of that 0.868 acre tract conveyed as Parcel II to Robert R. Hinkle and Georgina Marie Hinkle by deed of record in Instrument Number 201808220113201, the southerly line of that 0.728 acre tract conveyed to Pamela J. Russell by deed of record in Instrument Number 200205100118926, and the southerly line of that 0.74 acre tract conveyed to Sharon A. Wilkinson by deed of record in Instrument Number 201205150067904, a distance of 638.51 feet to a point in the westerly line of said 6.326 acre tract;

Thence with said westerly line the following courses and distances:

South 46° 23' 28" East, a distance of 1492.78 feet to a point of curvature;

With the arc of a curve to the right, having a central angle of 06° 00' 07", a radius of 2804.79 feet, an arc length of 293.81 feet, a chord bearing of South 43° 57' 34" East and chord distance of 293.68 feet to a point; and

South 40° 34' 15" East, a distance of 797.01 feet to the TRUE POINT OF BEGINNING, containing 63.851 acres of land, more or less.

This description is for annexation purposes only and is not to be used for transfer.

Total perimeter of annexation area is 7,505 feet, of which 1,135 feet is contiguous with the City of Columbus by Ordinance Number 1509-00, giving 15% perimeter contiguity.

SECTION 2. That the City Clerk is hereby authorized and directed to make three copies of this ordinance to each of which shall be attached a copy of the map accompanying the petition for annexation, a copy of the transcript of proceedings of the Board of County Commissioners relating thereto, and a certificate as to the correctness thereof, the City Clerk shall then forthwith deliver one copy to the County Auditor, one copy to the Board of Elections thereof and do such other things as may be required by law.

SECTION 3. That this ordinance shall take effect and be in force from and after the earliest period allowed by law.

Legislation Number: 2173-2023

Drafting Date: 7/11/2023

Version: 1

Current Status: Passed

Matter Type: Ordinance

BACKGROUND:

This ordinance approves the acceptance of certain territory (AN23-012) by the city of Columbus. The Ohio Revised Code stipulates that to be effective, City acceptance must take place a minimum of 60 days from the receipt by the City Clerk of the approval notice from the county. If City Council does not accept the ordinance within 120 days of its first consideration, the annexation will be considered rejected. This petition was filed with Franklin County on March 28, 2023. City Council approved a service ordinance addressing the site on April 17, 2023. Franklin County approved the annexation on May 2, 2023 and the City Clerk received notice on May 9, 2023.

FISCAL IMPACT:

Provision of municipal services does represent cost to the City; however, the annexation of land also has the potential to create revenue to the City.

To accept the application (AN23-011) of Bachman Farm Ltd. for the annexation of certain territory containing 30.7± acres in Madison Township.

WHEREAS, a petition for the annexation of certain territory in Madison Township was filed on behalf of Bachman Farm Ltd. on March 28, 2023; and

WHEREAS, the petition was considered and approved by the Franklin County Board of Commissioners at a hearing on May 2, 2023; and

WHEREAS, on May 9, 2023, the City Clerk received from Franklin County a certified copy of the resolution addressing the petition; and

WHEREAS, sixty days have now elapsed since receipt of the resolution in accordance with the provisions of the Ohio Revised Code; and

WHEREAS, it is in the best interest of the city of Columbus to accept the annexation of the territory addressed by the petition; now, therefore,

BE IT ORDAINED BY THE COUNCIL OF THE CITY OF COLUMBUS

SECTION 1. That the annexation proposed by Bachman Farm Ltd. in a petition filed with the Franklin County Board of Commissioners on March 28, 2023 and subsequently approved by the Board on May 2, 2023 is hereby accepted and said territory is hereby annexed to the city of Columbus. Said territory is described as follows:

Situated in the State of Ohio, County of Franklin, Township of Madison, in the northwest quarter of Section 14, Township 11, Range 21, Congress Lands, being all of that 30. 702 acre tract of land conveyed to Bachman Farm, Ltd. by deed of record in Instrument Number 202303220027313 (all references are to the records of the Recorder's Office, Franklin County, Ohio) and more particularly bounded and described as follows:

Beginning, for reference, at the centerline intersection of Winchester Pike (60' wide, see Franklin County right of way plans for S.H. 49, dated 1932) and Bachman Road (32' wide, created by Madison Township

Resolution/Agreement in 1905), at the center of said Section 14;

Thence North 04° 31' 29" East, with the common line of the northeast quarter and the northwest quarter of said Section 14, the westerly line of that tract conveyed as Tract One to Jerry Wildermuth and Gina Wildermuth, Trustees by deed of record in Instrument Number 201810220143701, a distance of 84.71 feet to a point in the easterly line of that 6.326 acre tract conveyed to Bachman Farm, Ltd. by deed of record in Instrument Number 202303220027313, the TRUE POINT OF BEGINNING for this description;

Thence North 40° 34' 15" West, with said easterly line, a distance of 445.52 feet to a point in the easterly line of that 0.582 acre tract conveyed to Jeremy Reeve and Cierra Reeve by deed of record in Instrument Number 202011180183710;

Thence North 04° 26' 19" East, with said easterly line and the easterly line of that 2.502 acre tract conveyed to Thomas O. Moore, Trustee by deed of record in Instrument Number 201107070084199, a distance of 383.28 feet to a point;

Thence with the boundary of said 2.502 acre tract the following courses and distances: North

40° 43' 25" West, a distance of 234.90 feet to a point; and

South 51° 04' 48" West, a distance of 274.79 feet to a point in the easterly line of said 6.326 acre tract;

Thence with said easterly line the following courses and distances:

With the arc of a curve to the left, having a central angle of 03° 16' 11", a radius of 2924.79 feet, an arc length of 166.92 feet, a chord bearing of North 45° 18' 49" West and chord distance of 166.89 feet to a point; and

North 46° 23' 28" West, a distance of 1344.69 feet to a point in the southerly line of that 56.06 acre tract conveyed as Tract Two to Ohio Lamb Farm, LLC by deed of record in Instrument Number 201509170131006, in the existing City of Columbus corporation line, as established by Ordinance Number 367-02, of record in Instrument Number 200207030164115;

Thence South 85° 31' 19" East, with said southerly line and said corporation line, a distance of 1853.78 feet to a point in the common line of the northeast quarter and the northwest quarter of said Section 14, in the westerly line of said Wildermuth tract;

Thence South 04° 31' 29" West, with said common line and said westerly line, a distance of 1631.13 feet to the TRUE POINT OF BEGINNING, containing 30.702 acres of land, more or less.

This description is for annexation purposes only and is not to be used for transfer.

Total perimeter of annexation area is 6,335 feet, of which 1,854 feet is contiguous with the City of Columbus by Ordinance Number 367-02, giving 29% perimeter contiguity.

SECTION 2. That the City Clerk is hereby authorized and directed to make three copies of this ordinance to each of which shall be attached a copy of the map accompanying the petition for annexation, a copy of the transcript of proceedings of the Board of County Commissioners relating thereto, and a certificate as to the correctness thereof, the City Clerk shall then forthwith deliver one copy to the County Auditor, one copy to the Board of Elections thereof and do such other things as may be required by law.

SECTION 3. That this ordinance shall take effect and be in force from and after the earliest period allowed by law.

Drafting Date: 7/12/2023

Current Status: Passed

Version: 1

Matter Type: Ordinance

This ordinance authorizes the Director of the Department of Technology, on behalf of various Departments, to enter into an agreement renewal with VCloud Tech, Inc. for the purchase of the annual renewal for software maintenance and support services for the City's Netmotion mobility solution and software licenses. The coverage term period for the software maintenance and support services for Netmotion software licenses is for one (1) year, from September 30, 2023 through September 29, 2024, at a cost of \$89,722.95.

The City uses NetMotion software to enable mobile workers, including police officers and public utility field crews, to utilize computer applications over cellular communication networks. Without the NetMotion solution, these applications will not function when accessed over a cellular network, significantly diminishing the effectiveness and efficiency of City police officers and other mobile workers.

On May 23, 2022, RFQ021951 was published, seeking bids for the purchase of annual software maintenance and support services for the City's Netmotion mobility solution and software licenses. The three (3) responses received were as follows:

- *VCloud Tech, Inc.: \$82,767.00
- * Brown Enterprise Solutions, LLC: \$84,087.75
- * CDWG: \$92,628.00

VCloud Tech, Inc. received the award as the lowest bidder as reported in ordinance 1219-2022.

The term of this renewal agreement shall be for one (1) year, from September 30, 2023 through September 29, 2024. This renewal agreement is not subject to automatic renewal. However, upon mutual agreement, to include the same pricing, terms and conditions as those set forth in the initial contract, the services may be renewed for one (1) additional one-year terms. Future renewal agreements of this contract will require authorization the Council of the City of Columbus.

EMERGENCY DESIGNATION

Emergency action is request to avoid disruptions to the above-described systems. Without the NetMotion solution, these applications will not function when accessed over a cellular network, significantly diminishing the effectiveness and efficiency of City police officers and other mobile workers, and possibly putting city police or other mobile workers at risk because of lack of communication or relevant information.

FISCAL IMPACT

In the year 2023, the Department of Technology is expected to expend \$89,722.95 for Netmotion annual software maintenance and support services. This year (2023) funds are budgeted and available within the Department of Technology's internal services budget and direct charge budget for this purpose. The direct charge budget enables pro-rating the cost among the various funds of the beneficiary departments (i.e., Public Safety, Public Utilities, Public Service, City Attorney, and Facilities Mgmt.).

CONTRACT COMPLIANCE

Vendor Name: VCloud Tech, Inc.: EBO_CC/C.C#: 012179 Expiration Date: 2/2/2024
(DAX City Vendor Acct. # No.: 012179)

To authorize the Director of the Department of Technology, for various Departments, to enter into a renewal agreement with VCloud Tech, Inc. for the renewal of annual software support and maintenance for Netmotion software licenses; to authorize the expenditure of \$89,722.95 from the Department of Technology, Information Services Operating Fund; and to declare an emergency (\$89,722.95).

WHEREAS, the City of Columbus uses Netmotion software to enable mobile workers, including police officers, public utility and public service field crews, to utilize computer applications over cellular communication networks; and

WHEREAS, on July 11, 2023 it was determined to utilize one (1) of the two (2) remaining renewals for the time period of September 30, 2023 to September 29, 2024. All renewals must be approved by City Council.

WHEREAS, this ordinance authorizes the Director of the Department of Technology, for various Departments, to enter into a renewal agreement with VCloud Tech, Inc. for the purchase and provision of annual software maintenance and support to the City's Netmotion mobility solution, in the amount of \$89,722.95, for the coverage term period from September 30, 2023 through September 29, 2024; and

WHEREAS, it is necessary to authorize the Director of the Department of Technology, for various Departments, to enter into a renewal agreement with VCloud Tech, Inc. for the purchase of annual software maintenance and support for the City's Netmotion mobility solution to avoid interruption of services, for the preservation of the public health, peace, property and safety; now, therefore

WHEREAS, an emergency exists in the usual daily operation of the Department of Technology in that it is immediately necessary to authorize the Director of Technology to enter in to contract renewal with VcloudTech, Inc. for Netmotion software maintenance and service support to avoid disruption in services without which various applications will not function when accessed over a cellular network, significantly diminishing the effectiveness and efficiency of City police officers and other mobile workers, and possibly putting city police or other mobile workers and possibly putting city police or other mobile workers at risk because of lack of communication or relevant information, thereby preserving the public health, peace, property, safety, and welfare; now, therefore:

BE IT ORDAINED BY THE COUNCIL OF THE CITY OF COLUMBUS:

SECTION 1: That the Director of the Department of Technology, for various City Departments, be and hereby is authorized to enter into a one (1) year renewal of the contract with VCloud Tech, Inc. as detailed in ordinance 1219-2022, for the purchase of annual software maintenance and support services for the City's Netmotion mobility solution in the amount of \$89,722.95 for the coverage term period from September 30, 2023 through September 29, 2024.

SECTION 2: That the expenditure of \$89,722.95 or so much thereof as may be necessary is hereby authorized to be expended from the Department of Technology internal services and direct charge budgets as follows in the attachment to this ordinance. **(see attachment 2174-2023 EXP)**

SECTION 3: That the City Auditor is authorized to make any accounting changes to revise the funding source for all contracts or contract modifications associated with this ordinance.

SECTION 4: That the funds necessary to carry out the purpose of this ordinance are hereby deemed appropriated, and the City Auditor shall establish such accounting codes as necessary.

SECTION 5: That for the reasons stated in the preamble hereto, which is hereby made a part hereof, this ordinance is hereby declared to be an emergency measure and shall take effect and be in force from and after its passage and approval by the Mayor, or ten days after passage if the Mayor neither approves nor vetoes the same.

Legislation Number: 2177-2023

Drafting Date: 7/12/2023

Current Status: Passed

Version: 1

Matter Type: Ordinance

BACKGROUND: This legislation authorizes the Director of the Department of Development to execute Grant Agreements with numerous not-for-profit, social service agencies funded from federal Emergency Rental Assistance funds (ERA 2) for the provision of assisting tenants with housing stability services through the funding of full time housing resource specialist positions for a period from August 1, 2023, to September 30, 2025. See attached Exhibit A for the list of 27 agencies included in this ordinance. The total amount to be awarded to these agencies is up to \$4,396,924.32.

Ordinance 2275-2021 authorizes the City of Columbus to accept and appropriate up to \$90,537,806.23 of federal Emergency Rental Assistance (ERA 2) program funds, as passed by the Consolidated Appropriations Act of 2021. Federal guidelines allows for payment of eligible expenses starting March 3, 2021.

Funding these not-for-profit, social service agencies is part of the department’s plan to expend the remaining ERA 2 funds. City Council recently approved Ordinance 1569-2023 to expend \$25 million to assist eligible recipients with funding to pay for rent, utility companies, and other service providers so they can remain in their home. These agreements will compliment those funds by providing funding for housing resource specialists to provide housing crisis counseling and assist tenants that are facing housing instability, eviction, and homelessness to navigate resources that are available to them.

The City of Columbus has a need to assist tenants with housing stability services within the ERA2 program as the city has seen a historic rise in eviction filings and housing instability. Funding for housing resource specialists will help facilitate services that will aide tenants who are in a housing crisis with accessing resources, as well as housing problem solving skills. The housing resource specialists will assist tenants in applying for rental and utility assistance that targets at-risk and vulnerable populations facing eviction, housing instability, and homelessness. This funding will provide 27 housing resource specialists that will form a collaborative within the Central Ohio Stable Housing Network to collaborate resources and assistance among nonprofit organizations within Franklin County.

The awards are given with an anticipated renewal in FY2024 and FY2025, pending availability of funds and program performance per agreements with each agency. The department shall submit, under separate legislation, pieces of legislation for additional Grant Agreements for this same purpose.

The department is entering into a Grant Agreement with the agency because funding will be advanced to the agency on a predetermined schedule. Advancement of funds is needed because many of the organizations do

not have funding available to be reimbursed for program expenses. The first advance will occur after confirmation of the Purchase Order. Before the second advance is made, the agency shall provide reports and documentation indicating how the funds were used to fulfill the scope of services in the Grant Agreement. This will continue throughout the term of the Grant Agreement.

Emergency action is necessary as the eviction and housing instability rate has reached historic levels. Individuals and families are in need of immediate intervention and supportive services to help with their housing crisis and remaining in their homes.

FISCAL IMPACT: Funding is available within Fund 2208, ERA 2 fund.

CONTRACT COMPLIANCE: See attached Exhibit A for a list of social services agencies and the vendor registration and contract compliance data.

To authorize the Director of the Department of Development to execute Grant Agreements with numerous not-for-profit, social service agencies, in an amount up to \$4,396,924.32, of U.S. Department of Treasury Emergency Rental Assistance 2 (ERA 2) funds to eligible recipients as part of the department's ERA 2 Strategy; to authorize an agreement start date of August 1, 2023; to authorize the payment of eligible expenses through September 30, 2025; to authorized the advancement of funds on a pre-determined schedule during the term of the agreement; to authorized the expenditure of up to \$4,396,924.32 from the Emergency Rental Assistance 2 Fund; and to declare an emergency. (\$4,396,924.32)

WHEREAS, the city has disbursed approximately \$23 million, and encumbered another \$25 million for disbursement, of the \$90.5 million of ERA 2 funds received from the U.S. Department of Treasury and the remaining \$62.5 million of ERA 2 funds will be disbursed under two programs; Investment Strategy and Innovations Strategy; and

WHEREAS, the department is building the Investment Strategy Program infrastructure to disburse over \$25 million to eligible recipients before the grant ends in December 2025; and

WHEREAS, 27 organizations are included in this piece of legislation with authorization for others agreements being submitted as separate pieces of legislation; and

WHEREAS, the Grant Agreements will be funded with Emergency Rental Assistance 2 Funds; and

WHEREAS, the Grant Agreements will allow for expenses starting August 1, 2023 and include advance payments to the organizations; and

WHEREAS, an emergency exists in the usual daily operation of the Department of Development in that it is immediately necessary to enter into Grant Agreements with various not-for-profit, social service agencies to help reduce the eviction and housing instability rates as it has reached historic levels, and individuals and families are in need of immediate intervention and supportive services to help with their housing crisis and remain in their homes, all for the preservation of the public health, peace, property, safety, and welfare; **NOW, THEREFORE**,

BE IT ORDAINED BY THE COUNCIL OF THE CITY OF COLUMBUS:

SECTION 1. That the Director of Development is authorized to execute Grant Agreements with numerous not-for-profit, social service agencies in an amount up to \$4,396,924.32 for the provision of assisting tenants with housing stability services through the funding of full time housing resource specialist positions for a period from August 1, 2023, to September 30, 2025, and is authorized to advance the funds on a pre-determined schedule during the term of the Gant agreement.

SECTION 2. That the expenditure of \$4,396,924.32 or so much thereof as may be needed is hereby authorized in Fund 2208 (ERA Fund), Dept-Div 44-10 (Housing Division), in object class 05 (Other) per the accounting codes in the attachment to this ordinance.

SECTION 3. That this agreement is awarded pursuant to the relevant provisions of Columbus City Code related to executing grant agreements.

SECTION 8. Funds are hereby deemed appropriated and expenditures and transfers authorized to carry out the purposes of this ordinance and the City Auditor shall establish such accounting codes as necessary.

SECTION 9. That the City Auditor is authorized to make any accounting changes to revise the funding source for all contracts or contract modifications associated with this ordinance.

SECTION 10. That for the reasons stated in the preamble hereto, which is hereby made a part hereof, this Ordinance is hereby declared to be an emergency measure and shall take effect and be in force from and after its approval by the Mayor, or ten days after passage if the Mayor neither approves nor vetoes the same.

Legislation Number: 2178-2023

Drafting Date: 7/12/2023

Current Status: Passed

Version: 1

Matter Type: Ordinance

BACKGROUND: This legislation authorizes the Director of the Department of Development to execute a Grant Agreement, in an amount up to \$400,000.00 of federal Emergency Rental Assistance 2 funds, with Columbus State Community College (CSCC) for the provision of funding housing-focused case management positions within its Success Bridge program for a period from August 1, 2023, to September 30, 2025.

Ordinance 2275-2021 authorizes the City of Columbus to accept and appropriate up to \$90,537,806.23 of federal Emergency Rental Assistance (ERA 2) program funds, as passed by the Consolidated Appropriations Act of 2021. Federal guidelines allows for payment of eligible expenses starting March 3, 2021.

Funding of case management positions at CSCC is part of the department’s plan to expend the remaining ERA 2 funds. City Council recently approved Ordinance 1569-2023 to expend \$25 million to assist eligible recipients with funding to pay for rent, utility companies, and other service providers so they can remain in their home. This agreement will compliment those funds by providing funding for case managers to support

at-risk students at CSCC.

The Success Bridge program is in its second phase of programming and focuses on providing a pathway to long-term sustainability for at-risk college students. The Success Bridge Program provides housing instable students housing counseling, success coaching, and connections to emergency rental assistance. The program also supports Columbus State students by providing access to housing services so they can complete their degrees and expand economic mobility after graduation. The program will prioritize Columbus Promise students, within the criteria of the program, to assist them in having stable housing to completing their degree.

Emergency action is necessary as the eviction and housing instability rate has reached historic levels and access to these resources are needed by students before classes begin in the autumn so they can work to stabilize their housing situation so they can focus on their classes.

FISCAL IMPACT: Funding is available within Fund 2208, ERA 2 fund.

CONTRACT COMPLIANCE: Columbus State Community College vendor number 004263 expires 05/30/2025.

To authorize the Director of Development to execute a Grant Agreement with Columbus State Community College for the provision of funding housing-focused case management positions within the Success Bridge program, in an amount up to \$400,000.00 of U.S. Department of Treasury Emergency Rental Assistance 2 (ERA 2) funds; to authorize an agreement start date of August 1, 2023; to authorized the expenditure of up to \$400,000.00 from the Emergency Rental Assistance 2 Fund; and to declare an emergency. (\$400,000.00)

WHEREAS, the city has disbursed approximately \$23 million, and encumbered another \$25 million for disbursement, of the \$90.5 million of ERA 2 funds received from the U.S. Department of Treasury and the remaining \$62.5 million of ERA 2 funds will be disbursed under two programs; Investment Strategy and Innovations Strategy; and

WHEREAS, the department is building the Investment Strategy Program infrastructure to disburse over \$25 million to eligible recipients before the grant ends in December 2025; and

WHEREAS, the Grant Agreement will be funded with Emergency Rental Assistance 2 Funds; and

WHEREAS, the Grant Agreement will allow for expenses starting August 1, 2023; and

WHEREAS, an emergency exists in the usual daily operation of the Department of Development in that it is immediately necessary to authorize the Director to enter into the grant agreement as the eviction and housing instability rate has reached historic levels and access to these resources are needed by students before classes begin in the autumn so they can work to stabilize their housing situation so they can focus on their classes, all for the immediate preservation of the public health, peace, property, safety, and welfare; and **NOW THEREFORE**,

BE IT ORDAINED BY THE COUNCIL OF THE CITY OF COLUMBUS:

SECTION 1. That the Director of Development is authorized to a execute Grant Agreement with Columbus State Community College, in an amount up to \$400,000.00 of federal Emergency Rental Assistance 2 funds,

for the provision of funding housing-focused case management positions within its Success Bridge program for a period from August 1, 2023, to September 30, 2025

SECTION 2. That the expenditure of \$400,000.00 or so much thereof as may be needed is hereby authorized in Fund 2208 (ERA Fund), Dept-Div 44-10 (Housing Division), in object class 05 (Other) per the accounting codes in the attachment to this ordinance.

SECTION 3. That this agreement is awarded pursuant to the relevant provisions of Columbus City Code related to executing grant agreements.

SECTION 4. Funds are hereby deemed appropriated and expenditures and transfers authorized to carry out the purposes of this ordinance and the City Auditor shall establish such accounting codes as necessary.

SECTION 5. That the City Auditor is authorized to make any accounting changes to revise the funding source for all contracts or contract modifications associated with this ordinance.

SECTION 6. That for the reasons stated in the preamble hereto, which is hereby made a part hereof, this Ordinance is hereby declared to be an emergency measure and shall take effect and be in force from and after its approval by the Mayor, or ten days after passage if the Mayor neither approves nor vetoes the same.

Legislation Number: 2179-2023

Drafting Date: 7/12/2023

Version: 1

Current Status: Passed

Matter Type: Ordinance

BACKGROUND: This legislation authorizes the Director of the Department of Development to execute a Grant Agreement in an amount up to \$155,890.00 with Gladden Community House Inc., funded from federal Emergency Rental Assistance funds (ERA 2) for the provision of assisting tenants with housing stability services through the funding of full time housing resource specialist positions for a period from August 1, 2023, to September 30, 2025.

Ordinance 2275-2021 authorizes the City of Columbus to accept and appropriate up to \$90,537,806.23 of federal Emergency Rental Assistance (ERA 2) program funds, as passed by the Consolidated Appropriations Act of 2021. Federal guidelines allows for payment of eligible expenses starting March 3, 2021.

Funding this not-for-profit, social service agency is part of the department’s plan to expend the remaining ERA 2 funds. City Council recently approved Ordinance 1569-2023 to expend \$25 million to assist eligible recipients with funding to pay for rent, utility companies, and other service providers so they can remain in their home. This agreement along with other agreements that were submitted as a separate piece of legislation will compliment those funds by providing funding for housing resource specialists to provide housing crisis counseling and assist tenants that are facing housing instability, eviction, and homelessness to navigate resources that are available to them.

The City of Columbus has a need to assist tenants with housing stability services within the ERA2 program as the city has seen a historic rise in eviction filings and housing instability. Funding for housing resource

specialists will help facilitate services that will aide tenants who are in a housing crisis with accessing resources, as well as housing problem solving skills. The housing resource specialists will assist tenants in applying for rental and utility assistance that targets at-risk and vulnerable populations facing eviction, housing instability, and homelessness. This funding for a housing resource specialist (1 housing resource specialist) along with funding from a separate piece of legislation (27 housing resource specialists) will provide for a total of 28 housing resource specialists that will form a collaborative within the Central Ohio Stable Housing Network to collaborate resources and assistance among nonprofit organizations within Franklin County.

The awards are given with an anticipated renewal in FY2024 and FY 2025, pending availability of funds and program performance per agreements with each agency. The department shall submit, under separate legislation, pieces of legislation for additional Grant Agreements for this same purpose.

The department is entering into a Grant Agreement with the agency because funding will be advanced to the agency on a predetermined schedule. Advancement of funds is needed because many of the organizations do not have funding available to be reimbursed for program expenses. The first advance will occur after confirmation of the Purchase Order. Before the second advance is made, the agency shall provide reports and documentation indicating how the funds were used to fulfill the scope of services in the Grant Agreement. This will continue throughout the term of the Grant Agreement.

Emergency action is necessary as the eviction and housing instability rate has reached historic levels. Individuals and families are in need of immediate intervention and supportive services to help with their housing crisis and remaining in their homes.

FISCAL IMPACT: Funding is available within Fund 2208, ERA 2 fund.

CONTRACT COMPLIANCE: Gladden Community House Inc., 006075 expires 06/20/205.

To authorize the Director of the Department of Development to execute a Grant Agreement with Gladden Community House Inc., in an amount up to \$155,890.00, of U.S. Department of Treasury Emergency Rental Assistance 2 (ERA 2) funds to eligible recipients as part of the department's ERA 2 Strategy; to authorize an agreement start date of August 1, 2023; to authorize the payment of eligible expenses through September 30, 2025; to authorized the advancement of funds on a pre-determined schedule during the term of the agreement; to authorized the expenditure of up to \$155,890.00 from the Emergency Rental Assistance 2 Fund; and to declare an emergency. (\$155,890.00)

WHEREAS, the city has disbursed approximately \$23 million, and encumbered another \$25 million for disbursement, of the \$90.5 million of ERA 2 funds received from the U.S. Department of Treasury and the remaining \$62.5 million of ERA 2 funds will be disbursed under two programs; Investment Strategy and Innovations Strategy; and

WHEREAS, the department is building the Investment Strategy Program infrastructure to disburse over \$25 million to eligible recipients before the grant ends in December 2025; and

WHEREAS, one organization is included in this piece of legislation with authorization for others agreements were submitted as a separate piece of legislation; and

WHEREAS, the Grant Agreement will be funded with Emergency Rental Assistance 2 Funds; and

WHEREAS, the Grant Agreement will allow for expenses starting August 1, 2023 and include advance payments to the organizations; and

WHEREAS, an emergency exists in the usual daily operation of the Department of Development in that it is immediately necessary to enter into a Grant Agreement with Gladden Community House Inc., to help reduce the eviction and housing instability rates as it has reached historic levels, and individuals and families are in need of immediate intervention and supportive services to help with their housing crisis and remain in their homes, all for the preservation of the public health, peace, property, safety, and welfare; **NOW, THEREFORE**,

BE IT ORDAINED BY THE COUNCIL OF THE CITY OF COLUMBUS:

SECTION 1. That the Director of Development is authorized to execute a Grant Agreement with Gladden Community House Inc., in an amount up to \$155,890.00 for the provision of assisting tenants with housing stability services through the funding of full time housing resource specialist positions for a period from August 1, 2023, to September 30, 2025; and to authorize the advancement of funds on a pre-determined schedule during the term of the Gant agreement.

SECTION 2. That the expenditure of \$155,890.00 or so much thereof as may be needed is hereby authorized in Fund 2208 (ERA Fund), Dept-Div 44-10 (Housing Division), in object class 05 (Other) per the accounting codes in the attachment to this ordinance.

SECTION 3. That this agreement is awarded pursuant to the relevant provisions of Columbus City Code related to executing grant agreements.

SECTION 4. Funds are hereby deemed appropriated and expenditures and transfers authorized to carry out the purposes of this ordinance and the City Auditor shall establish such accounting codes as necessary.

SECTION 5. That the City Auditor is authorized to make any accounting changes to revise the funding source for all contracts or contract modifications associated with this ordinance.

SECTION 6. That for the reasons stated in the preamble hereto, which is hereby made a part hereof, this Ordinance is hereby declared to be an emergency measure and shall take effect and be in force from and after its approval by the Mayor, or ten days after passage if the Mayor neither approves nor vetoes the same.

Legislation Number: 2181-2023

Drafting Date: 7/12/2023

Version: 1

Current Status: Passed

Matter Type: Ordinance

BACKGROUND: Columbus Public Health has been awarded a grant from the Centers for Disease Control and Prevention. This ordinance is needed to accept and appropriate a total of \$250,000.00 in grant money to fund the STD Surveillance (SSuN) Grant Program, for the period of September 30, 2023 through September

29, 2024.

Columbus Public Health (CPH) is participating in the STD Surveillance Network (SSuN) program to better understand behavioral, demographic, and clinical information on gonorrhea cases. This information will allow CPH and the CDC to better understand the epidemiology of STDs and to inform national and local STD prevention efforts.

This ordinance is submitted as an emergency to allow the financial transaction to be posted in the city's accounting system as soon as possible. Up to date financial posting promotes accurate accounting, financial management, and ensures the continued operation of the grant. In order to meet grant deliverables required by the grantor and to avoid CPH of being at risk of forfeiture of the funds.

FISCAL IMPACT: The SSuN Grant Program is entirely funded by the Centers for Disease Control and Prevention.

To authorize and direct the Board of Health to accept a 2023-2024 STD Surveillance (SSuN) Grant from the Centers for Disease Control and Prevention; to authorize the appropriation of \$250,000.00 from the unappropriated balance of the Health Department Grants Fund; and to declare an emergency. (\$250,000.00)

WHEREAS, \$250,000.00 in grant funds have been made available through the Centers for Disease Control and Prevention for the SSuN Grant Program, for the period of September 30, 2023 through September 29, 2024; and.

WHEREAS, the City may receive additional funds awarded from the Centers for Disease Control and Prevention for the support of the SSuN Grant Program; and

WHEREAS, it is necessary to accept and appropriate these funds from the Centers for Disease Control and Prevention for the support of the SSuN Grant Program; and

WHEREAS, it is necessary to allow the City Auditor to transfer appropriation between object classes for the SSuN grant program as needed upon request by the Columbus Public Health department; and

WHEREAS, this ordinance is submitted as an emergency to allow the financial transaction to be posted in the city's accounting system as soon as possible. Up to date financial posting promotes accurate accounting, financial management, and ensures the continued operation of the grant. In order to meet grant deliverables required by the grantor and to avoid CPH being at risk for forfeiture of funds.

WHEREAS, an emergency exists in the usual daily operation of the Health Department in that it is immediately necessary to accept these grant funds from the Centers for Disease Control and Prevention and to appropriate these funds to the Health Department to ensure the immediate delivery of services required by the grantor and to avoid the Department of being at risk of forfeiture of the funds, all for the immediate preservation of the public health, peace, property, safety and welfare; **Now, therefore,**

BE IT ORDAINED BY THE COUNCIL OF THE CITY OF COLUMBUS:

SECTION 1. That the Board of Health is hereby authorized and directed to accept a grant award of \$250,000.00 from the Centers for Disease Control and Prevention for the SSuN Grant Program, for the period

of September 30, 2023 through September 29, 2024

SECTION 2. That the Board of Health is hereby authorized and directed to accept additional grant awards from the Centers for Disease Control and Prevention for the SSuN Grant Program, for the period of September 30, 2023 through September 29, 2024

SECTION 3. That from the unappropriated monies in the Health Department Grants Fund, Fund No. 2251, and from all monies estimated to come into said fund from any and all sources and unappropriated for any other purpose during the fiscal year ending September 29, 2024, the sum of \$250,000.00 and any additional awarded funds and any eligible interest earned during the grant period is hereby appropriated upon receipt of an executed grant agreement to the Health Department, Division No. 50, per the accounting codes attached to this ordinance.

SECTION 4. That the monies appropriated in the foregoing Section 2 shall be paid upon the order of the Health Commissioner and that no order shall be drawn or money paid except upon voucher, the form of which shall be approved by the City Auditor.

SECTION 5. That the City Auditor is hereby authorized to transfer appropriation between object classes for the SSuN grant program as needed upon request by the Columbus Public Health Department to carry out the purpose of the grant.

SECTION 6. That at the end of the grant period, any repayment of unencumbered balances required by the grantor is hereby authorized and any unused city match monies may be transferred back to the city fund from which they originated in accordance with all applicable grant agreements.

SECTION 7. That the funds necessary to carry out the purpose of this ordinance are hereby deemed appropriated, and the City Auditor shall establish such accounting codes as necessary.

SECTION 8. That all related fee revenue income is hereby deemed appropriated.

SECTION 9. That for reasons stated in the preamble hereto, which is hereby made a part hereof, this ordinance is hereby declared to be an emergency measure and shall take effect and be in force from and after its passage and approval by the Mayor, or ten days after passage if the Mayor neither approves nor vetoes the same.

Legislation Number: 2183-2023

Drafting Date: 7/12/2023

Version: 1

Current Status: Passed

Matter Type: Ordinance

Council Variance Application: CV21-096

APPLICANT: Lykens Companies; c/o Dave Perry, Agent; David Perry Company; 411 East Town Street, 1st Floor; Columbus, OH 43215, and Donald Plank, Atty.; Plank Law Firm; 411 East Town Street, 2nd Floor; Columbus, OH 43215.

PROPOSED USE: Single-unit residential development and non-accessory parking.

GERMAN VILLAGE COMMISSION RECOMMENDATION: Approval.

CITY DEPARTMENTS' RECOMMENDATION: Approval. The site consists of nine parcels zoned in the R-2F, Residential District; two developed with single-unit dwellings, and the remaining seven developed as a 54-space non-accessory parking lot as approved by Ordinance 2432-2003 (CV03-032), which also permits office and restaurant uses for the Engine House No. 5 building located at 121 Thurman Avenue (now a 12,000 square foot office building). The requested Council variance will reconfigure the existing parcels into 14 lots for 11 new single-unit dwellings, the two existing single-unit dwellings, a “reserve” area for vehicular access and maneuvering, and an eight-space parking lot for the commercial uses at 121 Thurman Avenue. A Council variance is required because the R-2F, Residential District does not permit parking or commercial vehicular access as primary use. Variances are also included for maneuvering, parking lot landscaping and screening, vision clearance, lot width, lot area, lot coverage, fronting, building lines, side yards, rear yards, and private garage. The site is located within the boundaries of the German Village Commission, and is subject to Certificate of Appropriateness issuance for the new dwellings. The request is consistent with other residential infill developments in historic neighborhoods, will permit off-site parking for an adjacent commercial use, and will not add new or incompatible uses to the area.

To grant a Variance from the provisions of Sections 3332.037, R-2F, Residential district; 3312.25, Maneuvering; 3312.21(D)(1), Landscaping and screening; 3321.05(B)(2), Vision clearance; 3332.05, Area district lot width requirements; 3332.14, R-2F area district requirements; 3332.18(D), Basis of computing area; 3332.19, Fronting; 3332.21, Building lines; 3332.25, Maximum side yards required; 3332.26, Minimum side yard permitted; 3332.27, Rear yard; and 3332.28(E), Private garage, of the Columbus City Codes; for the property located at **133 THURMAN AVE. (43206)**, to permit a non-accessory parking lot, vehicular access, and reduced development standards for single-unit dwellings in the R-2F, Residential District (Council Variance #CV21-096).

WHEREAS, by application #CV21-096, the owner of the property at **133 THURMAN AVE. (43206)**, is requesting a Variance to permit a non-accessory parking lot, vehicular access, and reduced development standards for single-unit dwellings in the R-2F, Residential District; and

WHEREAS, Section 3332.037, R-2F, Residential district, prohibits vehicular access and parking as primary uses, while the applicant proposes eight off-site parking spaces for an adjacent commercial property on Parcel 11, and to allow commercial vehicular access through an easement on Reserve A and Parcels 12, 13, and 14, as shown on the submitted site plan; and

WHEREAS, Section 3312.25, Maneuvering, requires parking spaces to have sufficient access and maneuvering area on the lot where the parking spaces are located, while the applicant proposes maneuvering to cross parcels lines, but with all provided parking spaces having the total code required maneuvering area; and

WHEREAS, Section 3312.21(D)(1), Parking lot screening, requires headlight screening of a parking lot along a public street, and requires screening of a parking lot within 80 feet of residentially zoned property within a landscaped area at least four feet in width and no less than five feet in height, while the applicant proposes a reduced buffer strip along the north, south and east sides of Parcel 11 from four feet to three feet, with reduced screening height from five to three feet; and

WHEREAS, Section 3321.05(B)(2), Vision clearance, requires a clear vision triangle of 30 feet on each residential lot adjacent to a street intersection, while the applicant proposes a reduced clear vision triangle of 10 feet at the southeast intersection of Thurman Avenue and South 4th Street; and

WHEREAS, Section 3332.05, Area district lot width requirements, requires a lot no less than 50 feet wide, while the applicant proposes reduced lot widths between 20 feet and 44 feet, as shown on the submitted site plan; and

WHEREAS, Section 3332.14, R-2F area district requirements, requires a single-unit dwelling or other principal building to be situated on a lot of no less than 6,000 square feet in area, while the applicant proposes reduced lot area between 1,698 square feet and 5,140 square feet for Parcels 1-14, pursuant to lot area calculation in 3332.18(C); and

WHEREAS, Section 3332.18(D), Basis of computing area, prohibits buildings from occupying more than 50 percent of the lot area, while the applicant proposes to increase the lot coverage to 57 percent for Parcels 1, 7, 8, 9, 10 and 14; and

WHEREAS, Section 3332.19, Fronting, requires a dwelling unit to have frontage on a public street, while the applicant proposes no frontage for the dwellings on Parcels 7, 8, 9, 10 and 11 which will front on a public alley; and

WHEREAS, Section 3332.21, Building lines, requires the building setback line to be the average distance of building setbacks on contiguous lot or parcels, but in no case less than 10 feet, while the applicant proposes reduced building lines along Thurman Avenue for Parcels 1, 2, 3, 4 and 5 from 24 feet to 4 feet, 12 feet, 10 feet, 7 feet, and 15 feet, respectively, and to reduce the Parcel 1 setback along South 4th Street from 10 feet to 2 feet for the single-unit dwelling and to 6 feet for the detached garage; and

WHEREAS, Section 3332.25, Maximum side yards required, requires the sum of the widths of the side yards to be 20 percent of the lot width, while the applicant proposes to maintain reduced maximum side yards from 6.2 feet to 5 feet for Parcel 5, and to 4 feet for Parcel 4; and

WHEREAS, Section 3332.26, Minimum side yard permitted, requires side yards to be no less than three feet, while the applicant proposes reduced side yards of one foot for Parcel 4 and two feet for Parcel 14; and

WHEREAS, Section 3332.27, Rear yard, requires a rear yard totaling no less than 25 percent of the total lot area, while the applicant proposes reduced rear yards of 12 percent for Parcels 12, 13, and 14; and

WHEREAS, Section 3332.38(E), Private garage, requires a detached garage to not occupy more than 45 percent of the total rear yard, while the applicant proposes detached garages that occupy 51 percent of the rear yard for Parcels 7, 8, 9, and 10; and

WHEREAS, the German Village Commission recommends approval; and

WHEREAS, City Departments recommend approval because the requested Council variance will permit new single-unit dwellings consistent with residential infill development within historic neighborhoods, and commercial parking and vehicular access that will not add a new or incompatible uses to the area; and

WHEREAS, said ordinance requires separate submission for all applicable permits and Certificates of Occupancy for the proposed dwellings; and

WHEREAS, said variance will not adversely affect the surrounding property or surrounding neighborhood; and

WHEREAS, the granting of said variance will not impair an adequate supply of light and air to adjacent properties or unreasonably increase the congestion of public streets, or unreasonably diminish or impair established property values within the surrounding area, or otherwise impair the public health, safety, comfort, morals, or welfare of the inhabitants of the City of Columbus; and

WHEREAS, the granting of said variance will alleviate the difficulties encountered by the owners of the property located at **133 THURMAN AVE. (43206)**, in using said property as desired; and

BE IT ORDAINED BY THE COUNCIL OF THE CITY OF COLUMBUS:

SECTION 1. That a variance is hereby granted from the provisions of Sections 3332.037, R-2F, Residential district; 3312.25, Maneuvering; 3312.21(D)(1), Landscaping and screening; 3321.05(B)(2), Vision clearance; 3332.05, Area district lot width requirements; 3332.14, R-2F area district requirements; 3332.18(D), Basis of computing area; 3332.19, Fronting; 3332.21, Building lines; 3332.25, Maximum side yards required; 3332.26, Minimum side yard permitted; 3332.27, Rear yard; and 3332.28(E), Private garage, of the Columbus City Codes; for the property located at **133 THURMAN AVE. (43206)**, insofar as said sections prohibit vehicular access and parking as primary uses in the R-2F, Residential District; with maneuvering over parcel lines; a reduced vision clearance triangle from 30 to 10 feet at the southeast intersection of Thurman Avenue and South 4th Street; reduced landscaping buffer from four to three feet in width along the north, east and south sides Parcel 11, and reduced landscaping height from five to three feet along the north and south sides of Parcel 11; reduced lot widths from 50 feet to between 20 feet and 44 feet; reduced lot area from 6,000 square feet to between 1,698 and 5,140 square feet for Parcels 1-14; increased lot coverage from 50 to 57 percent for Parcels 1, 7, 8, 9, 10, and 14; no fronting for the dwellings on Parcels 7, 8, 9, 10 and 11; reduced building lines along Thurman Avenue from 24 feet to 4, 12, 10, 7, and 15 feet for Parcels 1, 2, 3, 4, and 5, respectively, and for Parcel 1 along South 4th Street from 10 feet to 2 feet for the single-unit dwelling and 6 feet for the detached garage; reduced maximum side yards from 6.2 feet to 5 feet and 4 feet for Parcel 1 and Parcel 4, respectively; reduced minimum side yards from three feet to one foot and two feet for Parcels 4 and 14, respectively; reduced rear yards from 25 to 12 percent for Parcels 12, 13, and 14; and increased rear yard coverage for a detached garage from 45 to 51 percent for Parcels 7, 8, 9 and 10; said property being more particularly described as follows:

133 THURMAN AVE. (43206), being 1.02± acres located at the southeast corner of Thurman Avenue and South 4th Street, and being more particularly described as follows:

DESCRIPTION OF 1.016 ACRES

Situated in the State of Ohio, County of Franklin, Truro Township, City of Columbus, being located in Half Section 28, Township 5, Range 22, Refugee Lands, being all of those tracts of land described in a deed to **121 Thurman LLC**, of record in Instrument Number 201701240011871, hereafter collectively referred to as the 121 Thurman tract, being that tract of land described in a deed to **147 Thurman LLC**, of record in Instrument Number 201703220039450, and being all of that tract of land described in a deed to **157 Thurman LLC**, of record in Instrument Number 201701100004613, all records referenced herein are on file at the Office of the Recorder for Franklin County, Ohio, and being further bounded and described as follows:

BEGINNING at the intersection of the existing south right-of-way line for Thurman Avenue (60 feet wide - public) and the existing east right-of-way line for 4th Street (50 feet wide - public), being the northwest corner of said 121 Thurman tract;

Thence **South 85 degrees 40 minutes 25 seconds East**, along the existing south right-of-way line for Thurman

Avenue, along the north line of said 121 Thurman tract, along the north line of said 147 Thurman tract and along the north line of said 157 Thurman tract, a distance of **208.83 feet** to the northeast corner of said 157 Thurman tract;

Thence **South 04 degrees 13 minutes 53 seconds West**, along the east line of said 157 Thurman tract, a distance of **212.00 feet** to the southeast corner of said 157 Thurman tract, being on the existing north right-of-way line for Nursery Lane (variable width - public);

Thence **North 85 degrees 40 minutes 25 seconds West**, along the existing north right-of-way line for Nursery Lane, along the south line of said 157 Thurman tract and along the south line of said 121 Thurman tract, a distance of **208.82 feet** to the intersection of the existing north right-of-way line for Nursery Lane and the existing east right-of-way line for 4th Street, being the southwest corner of said 121 Thurman tract;

Thence **North 04 degrees 13 minutes 41 seconds East**, along the existing east right-of-way line for 4th Street and along the west line of said 121 Thurman tract, a distance of **212.00 feet** to the **POINT OF BEGINNING** for this description.

The above description contains a total area of **1.016 acres**, of which:

0.083 acres is located within Franklin County Auditor's parcel number 010-052156,

0.041 acres is located within Franklin County Auditor's parcel number 010-040231,

0.041 acres is located within Franklin County Auditor's parcel number 010-044113,

0.083 acres is located within Franklin County Auditor's parcel number 010-044114,

0.049 acres is located within Franklin County Auditor's parcel number 010-248198,

0.115 acres is located within Franklin County Auditor's parcel number 010-029311,

0.116 acres is located within Franklin County Auditor's parcel number 010-017760,

0.083 acres is located within Franklin County Auditor's parcel number 010-010232,

0.405 acres is located within Franklin County Auditor's parcel number 010-057226.

Bearings described herein are based on South 85 degrees 40 minutes 25 seconds East for the south right-of-way line for Thurman Avenue, measured from Grid North, referenced to the Ohio State Plane Coordinate System (South Zone) and the North American Datum of 1983 (2011 Adjustment), as established utilizing a GPS survey and an NGS OPUS solution.

SECTION 2. That this ordinance is conditioned on and shall remain in effect only for so long as said property is used for an eight-space off-site parking lot (Parcel 11), vehicular access (Reserve A), single-unit dwellings, or those uses permitted in the R-2F, Residential District.

SECTION 3. That this ordinance is further conditioned on the Subject Site being developed in general conformance with the site plan titled, "**ZONING PLAN FOR THURMAN & S 4TH**," dated May 8, 2023, and signed by David B. Perry, Agent for the Applicant and Donald Plank, Attorney for the Applicant. The plan

may be slightly adjusted to reflect engineering, topographical, or other site data developed at the time of the development and when engineering and architectural drawings are completed. Any slight adjustments to the plan shall be subject to review and approval by the Director of the Department Building and Zoning Services, or a designee, upon submission of the appropriate data regarding the proposed adjustment.

SECTION 4. That this ordinance is further conditioned upon the applicant obtaining all applicable permits and Certificates of Occupancy for the proposed dwellings.

SECTION 5. That Ordinance #2432-2003 (CV03-032), passed December 8, 2003, shall no longer apply to the subject site.

SECTION 6. That this ordinance shall take effect and be in force from and after the earliest period allowed by law.

Legislation Number: 2185-2023

Drafting Date: 7/12/2023

Current Status: Passed

Version: 1

Matter Type: Ordinance

To authorize the Director of the Department of Finance and Management to associate all General Budget reservations resulting from this ordinance with the appropriate Universal Term Contract Purchase Agreement for Front End and Rear End Loading Refuse Trucks for the Division of Refuse Collection with Ohio Machinery Co. dba Ohio Peterbilt; to authorize the expenditure of up to \$3,040,618.00 from the Refuse Bond Fund for these trucks; and to declare an emergency. (\$3,040,618.00)

WHEREAS, the Division of Refuse Collection needs to replace four front end loading, and two rear end loading refuse trucks that have reached the end of their useful life; and

WHEREAS, the Division of Fleet Management has approved replacing these vehicles; and

WHEREAS, it is necessary to authorize the expenditure of up to \$3,040,618.00 from the Refuse Bond Fund, Fund 7703, to purchase these vehicles; and

WHEREAS, it has become necessary in the usual daily operation of the Department of Public Service to authorize the Director of Finance and Management to associate all general budget reservations with the appropriate universal term contracts with Ohio Machinery Co. dba Ohio Peterbilt in accordance with the terms, conditions and specifications of the Universal Term Contract Purchase Agreement, which will be on file in the Purchasing Office; and

WHEREAS, an emergency exists in the usual daily operation of the Department of Public Service in that it is immediately necessary to authorize the Director of Finance & Management to enter into contracts to purchase front and rear loading refuse trucks to replace trucks that are currently unavailable due to mechanical repairs that are not cost effective or the vehicles are no longer operational, thereby preserving the public health, peace, property, safety, and welfare; **NOW, THEREFORE,**

BE IT ORDAINED BY THE COUNCIL OF THE CITY OF COLUMBUS:

SECTION 1. That the Director of Finance and Management be and is hereby authorized to associate all

General Budget Reservations resulting from this ordinance with the appropriate Universal Term Contract Purchase Agreement for the purchase of Front and Rear Loading Refuse Trucks with Ohio machinery dba Ohio Peterbilt, for the Division of Refuse Collection.

SECTION 2. That the expenditure of \$3,040,618.00, or so much thereof as may be needed, is hereby authorized in Fund 7703 (Refuse Bond Fund), Dept-Div 5902 (Division of Refuse Collection), P520001-100000 (59-02 Mechanized Collection Equipment), in Object Class 06 (Capital Outlay), per the account codes in the attachment to this ordinance.

SECTION 3. That City Council approves the purchase of more than \$100,000.00 from an individual universal term contract established for the purchase of refuse trucks for the Division of Refuse Collection.

SECTION 4. That the funds necessary to carry out the purpose of this ordinance are hereby deemed appropriated, and the City Auditor shall establish such accounting codes as necessary.

SECTION 5. That the City Auditor is authorized to make any accounting changes to revise the funding source for all contracts or contract modifications associated with this ordinance.

SECTION 6. That the City Auditor is hereby authorized to transfer the unencumbered balance in a project account to the unallocated balance account within the same fund upon receipt of certification by the Director of the Department administering said project that the project has been completed and the monies are no longer required for said project.

SECTION 7. That for the reasons stated in the preamble hereto, which is hereby made a part hereof, this ordinance is hereby declared to be an emergency measure and shall take effect and be in force from and after its passage and approval by the Mayor or ten days after passage if the Mayor neither approves nor vetoes the same.

Legislation Number: 2186-2023

Drafting Date: 7/12/2023

Version: 1

Current Status: Passed

Matter Type: Ordinance

BACKGROUND

This legislation authorizes the Director of the Department of Development to enter into a Grant Agreement with Ronald McDonald House Charities of Central Ohio, Inc., in an amount not to exceed \$1,000,000.00, to advance planning, design and construction of the new expansion to continue, providing more families with accommodations, comfort, care and support while their child is hospitalized.

The Ronald McDonald House Charities of Central Ohio, Inc., is a non-profit organization located just south of Nationwide Children's Hospital right across E. Livingston Avenue. Their mission is to provide families accommodations, comfort, care, and support while their child is hospitalized. Recently, the Ronald McDonald House, located on Parcel No. 010-028748-00, broke ground on their new expansion. Once complete, the new expansion will provide an additional 80 guest rooms to accommodate more families, new community rooms, expanded kitchen and dining area, green space for families, and necessary renovations to the existing buildings. The total cost of the project is estimated to be \$28 million.

FISCAL IMPACTS

Funding in the amount of \$1,000,000.00 is available through the Department of Development’s 2023 Capital Improvement Budget within the Development Taxable Bonds Fund, Fund 7739. The funding will need to be authorized for expenditure from Fund 7739.

CONTRACT COMPLIANCE

The vendor number is 043001 and contract compliance expires on 9/12/24.

To authorize the Director of the Department of Development to enter into a Grant Agreement with Ronald McDonald House Charities of Central Ohio, Inc., in an amount not to exceed \$1,000,000.00, to advance the planning, design and construction of the new expansion to their facility located at 711 E. Livingston Avenue across from Nationwide Children's Hospital; and to authorize the expenditure of \$1,000,000.00 from the Development Taxable Bond Fund. (\$1,000,000.00)

WHEREAS, the Ronald McDonald House Charities of Central Ohio, Inc., is a non-profit organization that helps reduce the financial burden for families when they must travel far from home to access medical care for their child; and

WHEREAS, the Ronald McDonald house at 711 East Livingston Avenue needs to expand its facility to construct 80 new guest rooms, new community rooms, an expanded kitchen and dining area, green space for families and renovations to existing buildings, in order to meet increased demand; and

WHEREAS, the City desires to provide Ronald McDonald House Charities of Central Ohio, Inc., with a \$1 million capital grant that will provide additional temporary housing accommodations for families in need during the time their child is hospitalized; and

WHEREAS, it is necessary to authorize the Director of the Department of Development to enter into a grant agreement with Ronald McDonald House Charities of Central Ohio, Inc., to support and advance the planning, design and construction of the expansion necessary to provide more families with housing accommodations, including comfort, care and support while their child is hospitalized; **NOW, THEREFORE,**

BE IT ORDAINED BY THE COUNCIL OF THE CITY OF COLUMBUS:

SECTION 1. That Council finds that providing a grant to Ronald McDonald House Charities of Central Ohio, Inc., advances the public purpose of providing temporary housing for families in need while their child is undergoing hospitalized treatment. Council authorizes the Director of the Department of Development to enter into a grant agreement with Ronald McDonald House Charities of Central Ohio, Inc., in an amount not to exceed \$1,000,000.00, to advance the planning, design and construction of the expansion that is needed to meet the increase in demand for temporary housing accommodations for families whose child is hospitalized.

SECTION 2. That the expenditure of \$1,000,000.00, or so much thereof as may be needed, is authorized in Fund 7739 (Development Taxable Bonds), Dept-Div 4401 (Administration), Project 200019-100000 (Ronald McDonald House - Capital Campaign), in Object Class 06 Capital Outlay per the account codes in the attachment to this Ordinance.

SECTION 3. That the funds necessary to carry out the purpose of this ordinance are deemed appropriated, and are authorized for expenditure to carry out the purposes of this ordinance, and the City Auditor shall establish such accounting codes as necessary.

SECTION 4. That the City Auditor is authorized to make any accounting changes to revise the funding source for all contracts or contract modifications associated with this ordinance.

SECTION 5. That the City Auditor is hereby authorized to transfer the unencumbered balance in a project account to the unallocated balance account within the same fund upon receipt of certification by the Director of the Department administering said project that the project has been completed and the monies are no longer required for said project.

SECTION 6. That this ordinance shall take effect and be in force from and after the earliest period allowed by law.

Legislation Number: 2187-2023

Drafting Date: 7/12/2023

Current Status: Passed

Version: 1

Matter Type: Ordinance

This legislation authorizes the Director of the Department of Development to enter into a grant agreement with Freedom Equity Inc. (FEI), in an amount up to \$1,500,000.00 for the purpose of providing support to the new micro loan program. Funding will be advanced to the agency on a predetermined schedule.

Freedom Equity, Inc., is a community development financial institution that was incorporated in 2021 to be an alternative lender for black-owned small businesses in Central Ohio. The goal is to improve the accessibility and affordability of capital to support black and minority owned businesses in Central Ohio. The vision is to create an inclusive economy where black entrepreneurs thrive with the primary objective of growing Central Ohio's economy by seeding the success of black businesses. Freedom Equity Inc. was born as an alternative lending institution focused on increasing economic prosperity for underserved businesses by providing affordable lending opportunities for the community.

Realizing the challenges experienced by borrowers of color, the Franklin County Business Growth and Equity Alliance, including Franklin County, the Columbus Urban League, and One Columbus, dedicated capital, staff, and in-kind resources to the development of the organization.

The micro loan program will serve 22-25 businesses with short term loans to use as working capital or to buy inventory supplies, furniture, fixtures, and equipment. In addition to providing loans, technical assistance and capacity building will be provided to support various lending program.

Fiscal Impact: The funding for this agreement, \$1,500,000.00, will be transferred from the General Fund Citywide Account to the Department of Development General Fund Budget.

Contract Compliance: The contract compliance number is 045745 and expires on 6/20/25.

To authorize the Director of the Department of Development to enter into a grant agreement with Freedom Equity, Inc. in an amount up to \$1,500,000.00 for a micro loan program to support small minority businesses; to authorize the transfer of \$1,500,000.00 between the Citywide Account and the Department of Development; to authorize the expenditure of up to \$1,500,000.00 from the General Fund; and to authorize the advancement of funds on a pre-determined schedule during the term of the agreement. (\$1,500,000.00)

WHEREAS, Freedom Equity, Inc., is a community development financial institution that was incorporated in 2021 to be an alternative lender for black-owned small businesses in Central Ohio; and

WHEREAS, the Franklin County Board of Commissioners, the Columbus Urban League, and One Columbus formed the Franklin County Business Growth & Equity Alliance (Equity Alliance) to develop a collection of action initiatives to stabilize, grow and sustain vulnerable businesses owned by local African American residents who are historically underserved, underrepresented and under-connected; and

WHEREAS, the Equity Alliance worked to set the foundation for a new Central Ohio-based, culturally competent, community development financial institution (CDFI) focused on increasing access to affordable and accessible capital products; and

WHEREAS, Freedom Equity, Inc. was created as a result of the work of Equity Alliance and the desire to resolve the challenges faced by minority businesses; and

WHEREAS, the goal is to improve the accessibility and affordability of capital to support black and minority owned businesses in Central Ohio and

WHEREAS, the vision is to create an inclusive economy where black entrepreneurs thrive with the primary objective of growing Central Ohio's economy by seeding the success of black businesses; and

WHEREAS, funds will be used to create a micro loan program to serve 22 to 25 businesses with short term loans to be used as working capital or to buy inventory supplies, furniture, fixture and equipment; and

WHEREAS, Freedom Equity will also provide technical assistance and capacity building to the businesses served to support various lending programs; and

WHEREAS, the City of Columbus would like enter into a grant agreement with Freedom Equity Inc to continue to provide loan services to small businesses to promote growth and economic development; **NOW THEREFORE,**

BE IT ORDAINED BY THE COUNCIL OF THE CITY OF COLUMBUS:

SECTION 1. That the Director of the Department of Development is authorized to enter into a grant agreement with Freedom Equity, Inc. in the amount up to \$1,500,000.00 for the purpose of providing support to the new micro loan program designed to assist minority and small businesses with access to capital and to advance funds on a pre-determined schedule during the term of the agreement.

SECTION 2. That the transfer of \$1,500,000.00 or so much thereof as may be needed, is hereby authorized within Fund 1000 (General Fund) from Dept-Div 45-01 (Financial Management), Object Class 10 (Transfer Out Operating) to Dept-Div 44-02 (Economic Development), Object Class 05 (Other) per the accounting codes in the attachment to this ordinance.

SECTION 3. For the purpose stated in Section 1, the expenditure of \$1,500,000.00 or so much thereof as may be needed, is hereby authorized in Fund 1000 General Fund in Object Class 05 Other per the accounting codes in the attached to this ordinance.

SECTION 4. That the funds necessary to carry out the purpose of this ordinance are hereby deemed appropriated, and the City Auditor shall establish such accounting codes as necessary.

SECTION 5. That the City Auditor is authorized to make any accounting changes to revise the funding source for all contract or contract modifications associated with this ordinance.

SECTION 6. That this ordinance shall take effect and be in force from and after the earliest period allowed by law.

Legislation Number: 2188-2023

Drafting Date: 7/12/2023

Version: 2

Current Status: Passed

Matter Type: Ordinance

Rezoning Application Z23-019

APPLICANT: State of Ohio FBO The Ohio State University c/o Jeffrey L. Brown, Atty.; 37 West Broad Street, Suite 460; Columbus, OH 43215.

PROPOSED USE: Parking lot.

DEVELOPMENT COMMISSION RECOMMENDATION: Approval (5-0) on July 13, 2023.

NEAR EAST AREA COMMISSION RECOMMENDATION: Approval.

CITY DEPARTMENTS' RECOMMENDATION: Approval. The 3.12± acre site consists of one undeveloped parcel in the ARLD, Apartment Residential and I, Institutional districts. The requested CPD, Commercial Planned Development District will permit the site to be redeveloped with a parking lot for Ohio State East Hospital. While the *Near East Area Plan* (2005), does not contain a land use recommendation for this site, the Plan does specify design guidelines for parking lots including screening from adjacent public streets with a four-foot high decorative metal tube or solid metal bar fence, and landscaping or a masonry or stone wall and buffer between the parking lot and adjacent residential uses. The applicant is proposing a four- to six- foot tall metal fence with a landscaped buffer in addition to internal tree preservation and green space with the parking lot, as shown on the site plan and fencing exhibit. With the fencing, landscaping, and overall site design proposed, the request is consistent with the Plan's recommendations.

To rezone **210 WINNER AVE. (43203)**, being 3.12± acres located at the northeast corner of Hawthorne Avenue and Winner Avenue, From: ARLD, Apartment Residential District and I, Institutional District, To: CPD, Commercial Planned Development District **and to declare an emergency.**(Rezoning #Z23-019).

WHEREAS, application #Z23-019 is on file with the Department of Building and Zoning Services requesting rezoning of 3.2± acres from ARLD, Apartment Residential District and I, Institutional District, to CPD, Commercial Planned Development District; and

WHEREAS, the Development Commission recommends approval of said zoning change; and

WHEREAS, the Near East Area Commission recommends approval of said zoning change; and

WHEREAS, the City Departments recommend approval of said zoning change because the requested CPD, Commercial Planned Development District will permit a parking lot that includes a site plan and fencing exhibit demonstrating landscaping, fencing, and overall site design consistent with the *Near East Area Plan's* recommendations; ~~now, therefore;~~ **and**

WHEREAS, an emergency exists in the usual daily operation in the City of Columbus on that it is immediately necessary to pass this ordinance due to the need to move forward with the construction of the parking lot so that the lot can be finished before the asphalt batch plants close this year for the immediate preservation of the public peace, property, health and safety; ~~now, therefore:~~

BE IT ORDAINED BY THE COUNCIL OF THE CITY OF COLUMBUS:

SECTION 1. That the Official Zoning Map of the City of Columbus, as adopted by Ordinance No. 0179 -03, passed February 24, 2003, and as subsequently amended, is hereby revised by changing the zoning of the property as follows:

210 WINNER AVE. (43203), being 3.12± acres located at the northeast corner of Hawthorne Avenue and Winner Avenue, and being more particularly described as follows:

DESCRIPTION OF 2.753 ACRES

Situated in the State of Ohio, County of Franklin, City of Columbus, Section 14, Township 5, Range 22, Refugee lands and being all out of that 4.250 acre tract of land as conveyed to Columbus Metropolitan Housing Authority, of record in Instrument No. 201708070108453, all references refer to the records of the Recorder's Office Franklin County Ohio and described as follows:

Beginning at a P.K. Nail found with an EMH&T Shiner at the intersection of the westerly right of way line of Hughes Street (35 feet-wide) and the northerly right of way line of Hawthorn Avenue (50 feet wide);

Thence North 86°38'07" West with said northerly right of way line a distance of 248.74 feet to an iron pin set at a point on a curve;

Thence with a new division line across said Columbus Metropolitan Housing Authority tract the following courses.

With an arc to the right having a radius of 11.50 feet a central angle of 55°26'49" an arc length of 11.13 feet, a

chord bearing of North 24°34'17" West and a chord distance of 10.70 feet to an iron pin set at a point of tangency;

North 03°09'07" East a distance of 441.22 feet to an iron pin set at a point of curvature;

With a curve to the right of way a radius of 17.50 feet a central angle of 76°38'09" an arc length of 23.41 feet, a chord bearing of North 41°28'11" East and a chord distance of 21.70 feet to a part of tangency in the southerly right of way line of Phale D Hale Drive (50 feet wide);

Thence South 86°30'22" East, with said southerly right of way line, a distance of 246.26 feet to a 3/4" pin found with a plastic cap inscribed EMH&T at the intersection of said southerly right of way line and the westerly right of way line of said Hughes Street;

Thence South 03°53'17" West, with said westerly right of way line, a distance of 467.21 feet to the **point of beginning** and containing 2.753 acres of land more or less;

**DESCRIPTION OF 0.373 ACRE
HUGHES STREET PUBLIC RIGHT-OF-WAY
BETWEEN HAWTHORNE AVENUE AND PHALE D. HALE DRIVE**

Situated in the State of Ohio, County of Franklin, City of Columbus, being all the right-of-way of Hughes Street, 35 feet in width, between the north right-of-way line of Hawthorne Avenue, 50 feet in width, and the south right-of-way line of Phale D. Hale Drive, 50 feet in width, and as originally established by the plats of Samuel Hughes Subdivision, of record in Plat Book 3, Page 272 and Theodore Leonard Jr. School Board Subdivision, of record in Plat Book 4, Page 405, all references herein being to the records of the Recorder's Office, Franklin County, Ohio, and being more particularly described as follows:

Beginning at a 1-inch iron pin found capped "H&G Engr. & Surveying" at the intersection of the easterly right-of-way line of Hughes Street with the southerly right-of-way line of Phale D. Hale Drive (formerly Clifton Avenue, Plat Book 1, Page 259), being also the northwesterly corner of Lot 1 of the Theodore Leonard Subdivision and the northwesterly corner of that 9.726-acre tract as described in a deed to The Ohio State University, of record in Instrument Number 199904090088853;

Thence South 3°54'48" West, along said easterly right-of-way line and the westerly line of said 9.726-acre tract, a distance of 464.69 feet to a Mag Nail set at the intersection of the northerly right-of-way line of Hawthorne Avenue, being also the southwest corner of Lot 1 of the Samuel Hughes Subdivision;

Thence North 86°26'41" West, crossing Hughes Street, a distance of 35.00 feet to a Mag Nail set at the southeasterly corner of Lot 3 of Samuel Sharps Subdivision, of record in Plat Book 2, Page 136 and at the southeasterly corner of that 2.753-acre tract as described in a deed to The State of Ohio for the benefit of The Ohio State University, of record in Instrument Number 201709010121817;

Thence North 3°54'48" East, along the westerly right-of-way line of Hughes Street and the easterly line of said 2.753-acre tract, a distance of 464.64 feet to a Mag Nail set at the intersection of the southerly right-of-way line of Phale D. Hale Drive and at the northeasterly corner of Lot 6 of David Jones Subdivision, of record in Plat Book 2, Page 119;

Thence South 86°31'14" East, again crossing Hughes Street, a distance of 35.00 feet to the **place of beginning** and containing 0.373 acre of land.

To Rezone From: ARLD, Apartment Residential District and I, Institutional District,

To: CPD, Commercial Planned Development District.

SECTION 2. That a Height District of thirty-five (35) feet is hereby established on the CPD, Commercial Planned Development District on this property.

SECTION 3. That the Director of the Department of Building and Zoning Services be, and is hereby authorized and directed to make the said change on the said original zoning map and shall register a copy of the approved CPD, Commercial Planned Development District and Application among the records of the Department of Building and Zoning Services as required by Section 3311.12 of the Columbus City Codes; said plan being titled, “**SITE PLAN,**” and fencing exhibit titled, “**EX A,**” both dated July 13, 2023, and text titled, “**CPD TEXT,**” dated July 6, 2023, all signed by Jeffrey L. Brown, Attorney for the Applicant, and the text reading as follows:

CPD TEXT

PROPOSED DISTRICT: CPD, Commercial Planned Development District

PROPERTY ADDRESS: 210 Winner Avenue

OWNER: State of Ohio FBO The Ohio State University

APPLICANT: The Ohio State University

DATE OF TEXT: 7/6/23

APPLICATION NUMBER: Z23-019

1. **INTRODUCTION:** The site is on the west side of Hughes Street between Hawthorne Avenue and Phale D Drive. Part of the site has been used for parking. The current zoning is in the ARLD and I districts, and the proposed zoning would be CPD permitting parking on the site.

2. **PERMITTED USES:** Parking for Ohio State East Hospital

3. **DEVELOPMENT STANDARDS:** Except as listed in the zoning text and on the submitted site plan, the applicable development standards are contained in Chapter 3356 C-4, Commercial of the Columbus City Code.

A. Density, Height, Lot and/or Setback Requirements.

Parking setback along Winner Avenue, Hawthorne Avenue and Phale D Hale Drive shall be 5 feet.

B. Access, Loading, Parking and/or Traffic Related Commitments:

Access will be from “Hughes Street.”

C. Buffering, Landscaping, Open Space and/or Screening Commitments:

1. The site plan shows an area where existing trees are being preserved and maintained.
2. The proposed fence is shown on submitted Exhibit A.
3. Minimum height of shrubbery shall be 3 feet at installation.

D. Building Design, and/or Interior-Exterior Treatment Commitments:

N/A

E. Dumpster, Lighting, Outdoor Display Areas, and/or other Environmental Commitments:

N/A

F. Graphics and Signage Commitments:

The applicable graphics standards shall be those contained in the City Code as they apply to C-4, Commercial District. Any variances shall be submitted to the Columbus Graphics Commission and the applicant shall file a graphics plan application for any freestanding signs on the parcel.

G. Miscellaneous Commitments:

Site Plan Revision Allowance: The Property shall be developed in accordance with the site plan; however, the Site Plan may be slightly adjusted to reflect engineering, topographical, or other site data established at the time of development and engineering plans are completed. The Director of the Department Building and Zoning Services or the Director's designee may approve any slight adjustment to the Site Plan upon submission of the appropriate data regarding the proposed adjustment.

H. Modification of Development Standards:

Section 3312.27 Parking Setback line: to reduce the parking setback along Winner Avenue, Hawthorne Avenue and Phale D Hale Drive from 10 to 5 feet.

4. **CPD REQUIREMENTS:**

A. Natural Environment: The site is on the west side of Hughes Street between Phale D Hale Drive and Hawthorne Avenue. Part of the site has been graveled and used for parking.

B. Existing Land Use: To the north across Phale D Hale Drive is residential; to the west across Winter Avenues is multi-family; to the south across Hawthorne Avenue is residential and to the east across Hughes Drive is Ohio State East Hospital.

C. Transportation and Circulation: Access from Hughes Avenue (see submitted site plan).

D. Visual Form of the Environment: See submitted plan.

E. View and Visibility: The applicant considered pedestrian and vehicular movement in layout of site.

F. Proposed Development: Parking.

G. Behavior Patterns: The property will serve the parking needs of Ohio State Hospital East.

H. Emissions: No adverse effect from emissions shall result from the proposed development

~~SECTION 4. That this ordinance shall take effect and be in force from and after the earliest period allowed by law.~~

SECTION 4. That for the reasons stated in the preamble hereto, which is hereby made a part hereof, this ordinance is hereby declared to be an emergency measure and shall take effect and be in force from and after its passage and approval by the Mayor or 10 days after its passage if the Mayor neither approves nor vetoes the same.

Legislation Number: 2189-2023

Drafting Date: 7/12/2023

Current Status: Passed

Version: 1

Matter Type: Ordinance

Background:

This legislation authorizes the transfer of appropriation in the amount of \$1,015,000.00 from Object Class 03 to Object Class 05 in the Department of Neighborhoods 2023 General Fund budget to align with the City of Columbus Grant Guidance.

The Department of Neighborhoods works from a foundation of devoted residents, committed neighborhood leaders and dedicated City workforce to resolve community concerns and tap into neighborhood potential, helping to build a stronger, more equitable Columbus. As the ‘front door’ to the city, the Department of Neighborhoods empowers residents, responds to their needs and protects their rights. This works includes supporting non-profit organizations that provide direct service to the community.

FISCAL IMPACT: Funding is available in the Department of Neighborhoods 2023 General Fund budget. Funding was appropriated in object class 03, but will transferred to object class 05.

EMERGENCY DESIGNATION: This ordinance is submitted as an emergency so as to allow these financial transactions to be posted in the city's accounting system as soon as possible to allow for the proper financial coding of grants to support community organizations.

To authorize the transfer of appropriation between object classes within the general fund to align with the City of Columbus Grant Guidance; and to declare an emergency. (\$1,015,000.00).

WHEREAS, a transfer of appropriations is necessary in the general fund; and

WHEREAS, this ordinance is submitted as an emergency so as to allow the financial transactions to be posted in the City's accounting system as soon as possible, promoting accurate accounting and financial management; and

WHEREAS, an emergency exists in the usual daily operation of the Office of the Auditor in that it is immediately necessary to authorize the Auditor to transfer funds, and make additional appropriations to allow for the proper financial coding of grants to support community organizations for the immediate preservation of the public, health, peace, property, safety and welfare; **NOW THEREFORE,**

BE IT ORDAINED BY THE COUNCIL OF THE CITY OF COLUMBUS:

SECTION 1. That the transfer of appropriation in the amount of \$1,015,000.00 or so much thereof as may be needed, is hereby authorized within Fund 1000 (General Fund), from Dept-Div 48-01 object class 03 (Services) to Dept-Div 48-01 to object class 05 (Grants) per the account codes in the attachment to this ordinance.

SECTION 2. That the funds necessary to carry out the purpose of this ordinance are hereby deemed appropriated and the City Auditor shall establish such accounting codes as necessary.

SECTION 3. That the City Auditor is authorized to make any accounting changes to revise the financial information for all actions authorized in this ordinance.

SECTION 4. That for the reasons stated in the preamble hereto, which is hereby made a part hereof, this ordinance is hereby declared to be an emergency measure and shall take effect and be in force from and after

its passage and approval by the Mayor, or ten days after passage if the Mayor neither approves nor vetoes the same.

Legislation Number: 2191-2023

Drafting Date: 7/13/2023

Current Status: Passed

Version: 1

Matter Type: Ordinance

1. BACKGROUND

The purpose of this ordinance is to authorize the Director of Finance and Management to enter into a purchase order with Fyda Freightliner Columbus, Inc., in order to purchase one 2023 Diesel-Powered Isuzu NPRHD Flatbed, for the Department of Public Service, Division of Refuse Collection. This purchase will assist the Division with expediting refuse collection throughout the City.

The Division of Refuse Collection Container Warehouse provides service throughout the City of Columbus fixing existing containers, and supplying new refuse and recycling containers to all Columbus residents. Due to long lead times associated with the production and delivery of new vehicles, and needed repairs and/or the replacement of current vehicles, this critical operation does not have enough functional vehicles to fulfill daily operations. Therefore, the purchase of a readily available vehicle appropriate for this type of operation is necessary to avoid the interruption of City services.

2. CONTRACT COMPLIANCE INFORMATION

The contract compliance number for Fyda Freightliner Columbus, Inc. is CC004301 and expires 4/14/2025.

3. FISCAL IMPACT

Funds for this purchase are available in the Refuse Bond Fund, Fund 7703.

4. REQUEST FOR WAIVER OF FORMAL COMPETITIVE BIDDING REQUIREMENTS

A request for waiver of the formal competitive bidding requirements of Columbus City Code Chapter 329 is requested for this purchase so that the Refuse Container Warehouse can fulfill the daily operational requirements associated with fixing and/or supplying new refuse and recycling containers to Columbus citizens. Without the immediate acquisition of an additional vehicle, the operation will be unable to complete all of the requested services in a timely manner.

5. MINORITY AND WOMAN OWNED BUSINESS ENTERPRISE & SMALL LOCAL BUSINESS ENTERPRISE PROGRAM

This expenditure is for an equipment purchase and is exempt from the MBE/WBE program

6. EMERGENCY DESIGNATION

Emergency action is requested to expedite delivery of the Diesel-Powered Isuzu NPRHD Flatbed for immediate use because the Division of Refuse Collection does not have enough functional vehicles to fulfill daily operations.

To authorize the Director of Finance and Management to establish a purchase order with Fyda Freightliner Columbus, Inc. for purchase of one (1) Diesel-Powered Isuzu NPRHD Flatbed for the Division of Refuse Collection; to authorize the expenditure of up to \$94,378.00 from the Refuse Bond Fund; to authorize the waiver of the competitive bidding requirements of the Columbus City Code; and to declare an emergency. (\$94,378.00)

WHEREAS, the Department of Public Service, Division of Refuse Collection have a need for a Diesel-Powered Isuzu NPRHD Flatbed; and

WHEREAS, the Director of Finance and Management is authorized to establish a purchase order with Fyda Freightliner Columbus, Inc. for purchase of one (1) Diesel-Powered Isuzu NPRHD Flatbed for the Division of Refuse Collection; and

WHEREAS, it is necessary for Council to authorize a waiver of the competitive bidding requirements of Columbus City Code to procure this equipment; and

WHEREAS, Funds for this purchase are available in the Refuse Bond Fund, Fund 7703; and

WHEREAS, an emergency exists in the usual daily operation of the Department of Public Service, Division of Refuse Collection, in that it is immediately necessary to authorize the Director of Finance and Management to establish a purchase order to expedite delivery of the equipment for immediate use because the Division of Refuse Collection does not have enough functional vehicles to fulfill daily operations, thereby preserving the public health, peace, property, safety and welfare; now, therefore:

BE IT ORDAINED BY THE COUNCIL OF THE CITY OF COLUMBUS:

SECTION 1. That the Director of Finance and Management be and is hereby authorized to establish a purchase order with Fyda Freightliner Columbus, Inc. for one (1) Diesel-Powered Isuzu NPRHD Flatbed , for the Division of Refuse Collection in accordance with specifications on file in the Purchasing Office.

SECTION 2. That the expenditure of \$94,378.00, or so much thereof as may be needed, is hereby authorized in Fund 7703 (Refuse Bond Fund), Dept-Div 5902 (Division of Refuse Collection), P520001-100000 (59-02 Mechanized Collection Equipment), in Object Class 06 (Capital Outlay) per the accounting codes in the attachment to this ordinance.

SECTION 3. That City Council finds it is in the best interest of the City of Columbus to waive the formal competitive bidding requirements of City Code Chapter 329.

SECTION 4. That the funds necessary to carry out the purpose of this ordinance are hereby deemed appropriated and the City Auditor shall establish such accounting codes as necessary.

SECTION 5. That the City Auditor is authorized to make any accounting changes to revise the funding source for all contracts or contract modifications associated with this ordinance.

SECTION 6. That the City Auditor is hereby authorized to transfer the unencumbered balance in a project account to the unallocated balance account within the same fund upon receipt of certification by the Director of the Department administering said project that the project has been completed and the monies are no longer required for said project.

SECTION 7. That for the reasons stated in the preamble hereto, which is hereby made a part hereof, this ordinance is hereby declared to be an emergency measure and shall take effect and be in force from and after its passage and approval by the Mayor or ten days after passage if the Mayor neither approves nor vetoes the same.

Legislation Number: 2192-2023

Drafting Date: 7/13/2023

Current Status: Passed

Version: 1

Matter Type: Ordinance

This ordinance authorizes the City Clerk to enter into a grant agreement with Winbush Enterprise Inc. (WEI), in support of their WEI Pardon/Re-entry Initiative. The program seeks to engage at least 100 restored residents in Franklin County to reach two specified goals:

- To encourage participants to use their minds to remove barriers and connect with resources aimed to improve their social and economic conditions to reduce recidivism;
- To reduce the rate of recidivism and/or new charges committed by 75 of the 100 participants through role-play and team building to increase self-knowledge, and personal responsibility, and gain respect for themselves through submission of either the Ohio Governor’s Expedited Pardon Project (OGEPP) paperwork or the traditional pardon, record sealing, and expungements of records.

Fiscal Impact: The funding of \$20,000.00 is available within the Neighborhood Initiatives subfund.

To authorize the City Clerk to enter into a \$20,000.00 grant agreement with Winbush Enterprises Inc. in support of their WEI Pardon/Re-entry Initiative; and to authorize an appropriation and expenditure within the Neighborhood Initiatives subfund. (\$20,000.00)

WHEREAS, at any given time there are approximately 50,000 individuals incarcerated at Ohio’s state correctional institutions; and

WHEREAS, an average of 20,000 of these individuals are released annually into Ohio’s communities; and

WHEREAS, restored citizen are faced with many barriers to re-entering society; and

WHEREAS, creating pathways for successful re-entry is of the utmost importance; **NOW, THEREFORE**,

BE IT ORDAINED BY THE COUNCIL OF THE CITY OF COLUMBUS:

SECTION 1. That the City Clerk is authorized to enter into a grant agreement with Winbush Enterprises, Inc., in support of their WEI Pardon/Re-entry Initiative, in an amount not to exceed \$20,000.00.

SECTION 2. That the City Auditor is authorized and directed to appropriate \$20,000.00 in the Neighborhood Initiatives subfund, fund 1000, subfund 100018, to Columbus City Council per the accounting codes in the attachment to this ordinance.

SECTION 3. That the expenditure of \$20,000.00 or so much thereof as may be needed pursuant to the action authorized in SECTION 1, is hereby authorized in the Neighborhood Initiatives subfund, fund 1000, subfund 100018, per the accounting codes in the attachment to this ordinance.

SECTION 4. That the funds necessary to carry out the purpose of this ordinance are hereby deemed appropriated, and the City Auditor shall establish such accounting codes as necessary.

SECTION 5. That the City Auditor is authorized to make any accounting changes to revise the funding source for all contracts or contract modifications associated with this ordinance.

SECTION 6. That this ordinance shall take effect and be in force from and after the earliest period allowed by law.

Legislation Number: 2201-2023

Drafting Date: 7/13/2023

Current Status: Passed

Version: 1

Matter Type: Ordinance

1. BACKGROUND:

This ordinance authorizes the City Auditor to set up a certificate in the amount of \$80,000.00 for the purchase and installation of snow and lighting equipment for the Department of Public Service, Division of Traffic Management. These purchases will be made through the City of Columbus Purchasing Office. All bids will be obtained and contracts awarded in compliance with the relevant provisions of the Columbus City Code Chapter 329. This ordinance will set up the funding required to enter into contract with the vendor on an as-needed basis. Competitive bids will be solicited and opened by the Purchasing Office, obtained through any current universal term contract, or state term contract as authorized by ordinance number 582-87. This equipment will be used by the Division of Traffic Management in the daily operation of traffic management duties and to clear snow from City of Columbus streets and public right of way.

2. FISCAL IMPACT: Funding is budgeted and available within the Municipal Motor Vehicle Tax Fund (2266).

3. MINORITY AND WOMAN OWNED BUSINESS ENTERPRISE & SMALL LOCAL BUSINESS ENTERPRISE PROGRAM

This expenditure will be made for equipment and as such does not require MWBE goals to be established.

4. EMERGENCY DESIGNATION

The department requests emergency designation for this legislation so that the snow and lighting equipment can be purchased and installed and be available for winter operations before the winter season begins.

To authorize and direct the City Auditor to set up a certificate in the amount of \$80,000.00 for the purchase and installation of snow and lighting equipment for the Department of Public Service, Division of Traffic Management; to authorize and direct the Director of Finance and Management to solicit bids and enter into contract for the purchase and installation of snow and lighting equipment on behalf of the Department of Public Service, Division of Traffic Management; to authorize the expenditure of up to \$80,000.00 from the Municipal Motor Vehicle Tax Fund; and to declare an emergency. (\$80,000.00).

WHEREAS, it is necessary that the City Auditor set up a certificate in the amount of \$80,000.00 for the purchase and installation of snow and lighting equipment for the Department of Public Service, Division of Traffic Management; and

WHEREAS, the Purchasing Office will solicit competitive bids in accordance with the relevant provisions of City Code Chapter 329 relating to competitive bidding; and

WHEREAS, it is necessary that the Director of Finance and Management enter into contract for the purchase and installation of snow and lighting equipment for the Department of Public Service, Division of Traffic Management; and

WHEREAS, this expenditure will be made for equipment and as such does not require MWBE goals to be established; and

WHEREAS, it is necessary to authorize the expenditure of up to \$80,000.00 from the Municipal Motor Vehicle Tax Fund, Fund 2266; and

WHEREAS, an emergency exists in the usual daily operations of the Department of Public Service in that it is immediately necessary to authorize the City Auditor to set up a certificate for the purchase and installation of snow and lighting equipment so that the Director of Finance and Management is able to solicit bids and enter into contract, so that the equipment will be available for winter operations thereby preserving the public health, peace, property, safety, and welfare; **NOW, THEREFORE.**

BE IT ORDAINED BY THE COUNCIL OF THE CITY OF COLUMBUS:

SECTION 1. That the City Auditor is hereby authorized to set up a certificate in the amount of \$80,000.00 for the purchase and installation of snow and lighting equipment for the Department of Public Service, Division of Traffic Management.

SECTION 2. That the Director of Finance and Management is hereby authorized to enter into contract for the purchase and installation of snow and lighting equipment for the Department of Public Service, Division of Traffic Management in accordance with the relevant provisions of the Columbus City Code Chapter 329 or using State Term Contracts authorized per ordinance number 582-87.

SECTION 3. That the expenditure of \$80,000.00, or as much thereof as may be needed, is hereby authorized in Fund 2266, the Municipal Motor Vehicle Tax Fund, Dept-Div 5913 (Department of Public Service, Division of Traffic Management) in Object Class 06 (Equipment) per the accounting codes in the attachment to this ordinance.

SECTION 4. That the funds necessary to carry out the purpose of this ordinance are hereby deemed appropriated, and the City Auditor shall establish such accounting codes as necessary.

SECTION 5. That the City Auditor is authorized to make any accounting changes to revise the funding source for all contracts or contract modifications associated with this ordinance.

SECTION 6. That this Council hereby recognizes that this ordinance does not identify specific contractors or vendors for the expenditure purposes authorized herein and hereby delegates sole and final contracting decisions relative to the determination of lowest, best, most responsive and most responsible vendor(s) to the Director of Public Service. All contracts will be entered into in compliance with the relevant provisions of the Columbus City Code, Chapter 329.

SECTION 7. That for reasons stated in the preamble hereto, where is hereby made a part hereof, this ordinance is hereby declared an emergency measure, which shall take effect and be in force from and after its passage and approved by the Mayor, or ten days after passage if the Mayor neither approves nor vetoes the same.

Legislation Number: 2202-2023

Drafting Date: 7/13/2023

Version: 1

Current Status: Passed

Matter Type: Ordinance

1. BACKGROUND

This ordinance authorizes the Director of Finance and Management, on behalf of the Director of Public

Service, to associate all General Budget Reservations resulting from this ordinance with the appropriate Universal Term Contract Purchase Agreement for the purchase of five (5) Compressed Natural Gas (CNG) Knuckle Boom Waste Trucks. This purchase has been approved by the Division of Fleet Management.

The Department of Public Service, Division of Refuse Collection, uses knuckle boom trucks in city-wide residential trash pick-up. The Department of Public Service and Fleet Management recognize the need to replace older trucks in its fleet beyond the useful service life of the vehicle. This purchase will replace five (5) refuse trucks that have reached the end of their useful service life. Three (3) Peterbilt 537 Chassis QUO-1007388-H8M4Z8 with Petersen TL3 Lightning Loader body refuse trucks, and two (2) Peterbilt Chassis QUO-1007388-H8M4Z8 with Petersen TL3 Route Assistant

The following Purchase Agreement association requires approval by City Council in order for the Division to expend more than \$100,000.00 in a fiscal year per City Code 329.19(g):

Ohio Machinery Company dba Ohio Peterbilt: Universal Term Contract Purchase Agreement, PA006315, Ordinance 3516-2022, for Knuckle Boom Waste Trucks.

Ohio Machinery Company dba Ohio Peterbilt is not debarred according to the Excluded Party Listing System of the Federal Government or prohibited from being awarded a contract according to the Auditor of State Unresolved Findings for Recovery Certified Search.

2. CONTRACT COMPLIANCE INFORMATION

The contract compliance number for Ohio Machinery Company dba Ohio Peterbilt is CC006428 and expires 6/8/2024.

3. FISCAL IMPACT:

Funding is available, appropriated and budgeted within the Refuse Bond Fund, Fund 7703.

4. MINORITY AND WOMAN OWNED BUSINESS ENTERPRISE & SMALL LOCAL BUSINESS ENTERPRISE PROGRAM

This expenditure is for an equipment purchase and is exempt from the MBE/WBE program.

5. EMERGENCY DESIGNATION

This ordinance is to be considered an emergency to meet the urgent need of replacing trucks that are currently unavailable due to mechanical repairs that are not cost effective or the vehicles are no longer operational. Also in the interest of saving time due to the elongated production and delivery times caused by supply chain disruption and heavy demand.

To authorize the Director of Finance and Management to associate all General Budget reservations resulting from this ordinance with the appropriate Universal Term Contract Purchase Agreement for Knuckle Boom Waste Trucks for the Division of Refuse Collection with Ohio Machinery Company dba Ohio Peterbilt; to authorize the expenditure of up to \$1,987,487.00 from the Refuse Bond Fund for these trucks; and to declare an emergency. (\$1, 987,487.00)

WHEREAS, the Division of Refuse Collection needs to replace five (5) knuckle boom waste trucks that have reached the end of their useful life; and

WHEREAS, the Division of Fleet Management has approved replacing these vehicles; and

WHEREAS, it is necessary to authorize the expenditure of up to \$1,987,487.00 from the Refuse Bond Fund, Fund 7703, to purchase these vehicles; and

WHEREAS, it has become necessary in the usual daily operation of the Department of Public Service to authorize the Director of Finance and Management to associate all general budget reservations with the appropriate universal term contracts with Ohio Machinery Company dba Ohio Peterbilt in accordance with the terms, conditions and specifications of the Universal Term Contract Purchase Agreement, which will be on file in the Purchasing Office; and

WHEREAS, an emergency exists in the usual daily operation of the Department of Public Service in that it is immediately necessary to authorize the Director of Finance & Management to enter into contracts to purchase knuckle boom refuse trucks to replace trucks that are currently unavailable due to mechanical repairs that are not cost effective or the vehicles are no longer operational. Also in the interest of saving time due to the elongated production and delivery times caused by supply chain disruption and heavy demand, thereby preserving the public health, peace, property, safety, and welfare; **now therefore**

BE IT ORDAINED BY THE COUNCIL OF THE CITY OF COLUMBUS:

SECTION 1. That the Director of Finance and Management be and is hereby authorized to associate all General Budget Reservations resulting from this ordinance with the appropriate Universal Term Contract Purchase Agreement for the purchase of Knuckle Boom Refuse Trucks with Ohio Machinery Company dba Ohio Peterbilt, for the Division of Refuse Collection.

SECTION 2. That the expenditure of \$1,987,487.00, or so much thereof as may be needed, is hereby authorized in Fund 7703 (Refuse Bond Fund), Dept-Div 5902 (Division of Refuse Collection), P520001-100000 (59-02 Mechanized Collection), in Object Class 06 (Capital Outlay), per the account codes in the attachment to this ordinance.

SECTION 3. That City Council approves the purchase of more than \$100,000.00 from an individual universal term contract established for the purchase of refuse trucks for the Division of Refuse Collection.

SECTION 4. That the funds necessary to carry out the purpose of this ordinance are hereby deemed appropriated, and the City Auditor shall establish such accounting codes as necessary.

SECTION 5. That the City Auditor is authorized to make any accounting changes to revise the funding source for all contracts or contract modifications associated with this ordinance.

SECTION 6. That the City Auditor is hereby authorized to transfer the unencumbered balance in a project account to the unallocated balance account within the same fund upon receipt of certification by the Director of the Department administering said project that the project has been completed and the monies are no longer required for said project.

SECTION 7. That for the reasons stated in the preamble hereto, which is hereby made a part hereof, this ordinance is hereby declared to be an emergency measure and shall take effect and be in force from and after its passage and approval by the Mayor or ten days after passage if the Mayor neither approves nor vetoes the same.

Legislation Number: 2203-2023

Drafting Date: 7/13/2023

Version: 1

Current Status: Passed

Matter Type: Ordinance

Council Variance Application: CV23-048

APPLICANT: North Central Holdings; c/o Dave Perry, Agent; David Perry Company; 411 East Town Street, 1st Floor; Columbus, OH 43215, and Donald Plank, Atty.; Plank Law Firm; 411 East Town Street, 2nd Floor; Columbus, OH 43215.

PROPOSED USE: Mixed use development.

FRANKLINTON AREA COMMISSION RECOMMENDATION: Approval.

CITY DEPARTMENTS' RECOMMENDATION: Approval. The site consists of a commercial building utilized for auto repair and a four-unit apartment building on one parcel zoned in the R-4, Residential District. The requested Council Variance will permit auto repair, office and retail uses, contractor, storage, and/or 3D printing uses. A Council variance is necessary because the R-4, Residential District does not permit the proposed uses. The request includes variances for lot width, lot size, minimum side yard, maximum side yard, driveway width, maneuvering, parking space size, and minimum number of parking spaces required. The site is within the planning area of the *West Franklinton Plan* (2014), which recommends "Medium-High Density" land uses at this location. Staff notes there have been commercial uses on the northern portion of the site which is also adjacent to commercially zoned property. The conceptual elevations for the proposed single-unit or two-unit dwelling on Parcel C are consistent with the design guidelines of the area plan and the *Columbus Citywide Planning Policies (C2P2) Design Guidelines* (2018). Staff supports the proposed mixed use development as it is consistent with the larger development pattern of the neighborhood.

To grant a Variance from the provisions of Sections 3332.039, R-4 residential district; 3312.13, Driveway; 3312.25, Maneuvering; 3312.29, Parking space; 3312.49(C), Minimum numbers of parking spaces required; 3332.05, Area district lot width requirements; 3332.15, R-4 area district requirements; 3332.18(C), Basis of computing area; 3332.21, Building lines; 3332.25, Maximum side yards required; 3332.26, Minimum side yard permitted, of the Columbus City Codes; for the property located at **172-180 N. CENTRAL AVE. (43222)**, to permit a mixed use development with reduced development standards in the R-4, Residential District (Council Variance #CV23-048).

WHEREAS, by application #CV23-048, the owner of the property at **172-180 N. CENTRAL AVE. (43222)**, is requesting a Variance to permit a mixed use development with reduced development standards in the R-4 Residential District; and

The following variances apply to Parcel A (R-4, Residential District):

WHEREAS, Section 3332.039, R-4, residential district, prohibits commercial and storage uses, while the applicant proposes auto repair, all office and retail uses, contractor, storage and 3D printing uses on this parcel; and

WHEREAS, Section 3312.13, Driveway, requires a minimum driveway width of 20 feet, while the applicant

proposes to reduce the width to 13 feet and to 10 feet for two-way access to parking spaces as shown on the site plan; and

WHEREAS, Section 3312.25, Maneuvering, requires every parking space to have sufficient access and maneuvering, while the applicant proposes to have stacked parking, as shown on the submitted site plan; and

WHEREAS, Section 3312.29, Parking space, requires each parking space to be accessible from a maneuvering area, while the applicant proposes to have stacked parking, as shown on the submitted site plan; and

WHEREAS, Section 3312.49(C), Minimum numbers of parking spaces required, requires six parking spaces for retail space containing 1,500 square feet, while the applicant proposes to provide four parking spaces; and

WHEREAS, Section 3332.05(A)(4), Area district lot width requirements, requires a minimum lot width of 50 feet in the R-4, Residential District, while the applicant proposes a reduced lot width of 34 feet; and

WHEREAS, Section 3332.18(C), Basis of computing area, requires a lot area calculation based on the lot length being no greater than three times the lot width, while the applicant proposes the actual lot area of 5,091 square feet as opposed to the 3,648 square feet that is pursuant to this lot area calculation; and

WHEREAS, Section 3332.21, Building lines, requires a 10 foot setback along North Central Avenue, while the applicant proposes to maintain a reduced setback of 2 feet; and

WHEREAS, Section 3332.26(C), Minimum side yard permitted, requires a minimum side yard of 5 feet, while the applicant proposes to maintain a minimum side yard of zero feet along the north side of the existing principal building; and

The following variances apply to Parcel B (R-4, Residential District):

WHEREAS, Section 3312.29, Parking space, requires each parking space to be a rectangular area of 9 feet wide by 18 feet deep while the applicant proposes five parking spaces that have a reduced width of 8 feet; and

WHEREAS, Section 3312.49(C), Minimum numbers of parking spaces required, requires 1.5 parking spaces per dwelling unit, or six parking spaces for a four-unit dwelling, while the applicant proposes to provide five parking spaces; and

WHEREAS, Section 3332.15, R-4 area district requirements, requires a four-unit dwelling to be situated on a lot of no less than 10,000 square feet in area, while the applicant proposes a reduced lot size containing 7,788 square feet; and

WHEREAS, Section 3332.26(C), Minimum side yard permitted, requires a minimum side yard of five feet, while the applicant proposes to maintain a minimum side yard of three feet along the south side of the building; and

The following variances apply to Parcel C (R-4, Residential District):

WHEREAS, Section 3312.29, Parking space, requires each parking space to be a rectangular area of nine feet wide by 18 feet deep which is accessible from a street, alley, or maneuvering area, while the applicant proposes stacked parking spaces with a reduced width of 8 feet, as shown on the submitted site plan; and

WHEREAS, Section 3332.05(A)(4), Area district lot width requirements, requires a minimum lot width of 50 feet in the R-4, Residential District, while the applicant proposes a reduced lot width of 33 feet; and

WHEREAS, Section 3332.15, R-4 area district requirements, requires a single-unit dwelling or other principal building to be situated on a lot of no less than 5,000 square feet in area, a two story, two-unit dwelling to be on a lot of no less than 6,000 square feet in area, while the applicant proposes a single-unit dwelling or a two-unit dwelling on a lot that contains 3,267 square feet (pursuant to lot area calculation in 3332.18(C)); and

WHEREAS, Section 3332.25, Maximum side yards required, requires the sum of the widths of the side yards to equal or exceed 20 percent of the width of the lot, a maximum requirement of 6.6 feet for a 33 foot wide lot, while the applicant proposes a maximum side yard of 6 feet for the two-unit dwelling; and

WHEREAS, Section 3332.26, Minimum side yard permitted, requires a minimum side yard of five feet for a two-unit building, while the applicant proposes a reduced side yard of three feet; and

WHEREAS, the Franklinton Area Commission recommends approval; and

WHEREAS, City Departments recommend approval because the proposed mixed used development is consistent with the larger development patterns of the neighborhood; and

WHEREAS, said ordinance requires separate submission for all applicable permits and Certificates of Occupancy for the proposed uses; and

WHEREAS, said variance will not adversely affect the surrounding property or surrounding neighborhood; and

WHEREAS, the granting of said variance will not impair an adequate supply of light and air to adjacent properties or unreasonably increase the congestion of public streets, or unreasonably diminish or impair established property values within the surrounding area, or otherwise impair the public health, safety, comfort, morals, or welfare of the inhabitants of the City of Columbus; and

WHEREAS, the granting of said variance will alleviate the difficulties encountered by the owners of the property located at **172-180 N. CENTRAL AVE. (43222)**, in using said property as desired; now, therefore:

BE IT ORDAINED BY THE COUNCIL OF THE CITY OF COLUMBUS:

SECTION 1. That a variance is hereby granted from the provisions of Sections 3332.039, R-4 residential district; 3312.13, Driveway; 3312.25, Maneuvering; 3312.29, Parking space; 3312.49(C), Minimum numbers of parking spaces required; 3332.05, Area district lot width requirements; 3332.15, R-4 area district requirements; 3332.18(C), Basis of computing area; 3332.21, Building lines; 3332.25, Maximum side yards required; and 3332.26, Minimum side yard permitted, of the Columbus City Codes; for the property located at **172-180 N. CENTRAL AVE. (43222)**, insofar as said sections prohibit:

- a) On Parcel A: auto repair, commercial retail and office, contractor, storage, and/or 3D printing uses; with a reduced driveway width from 20 feet to 13 feet and 10 feet; no access or maneuvering for stacked parking spaces; reduced number of required parking spaces from six parking spaces to four parking spaces; reduced minimum lot width from 50 feet to 34 feet; a lot area of 5,091 square feet as opposed to the required lot area calculation of 3,468 square feet; reduced setback along North Central Avenue from 10 feet to 2 feet; and reduced minimum side yard from five feet to zero feet along the north property line; and

- b) On Parcel B: a reduction in the width of parking spaces from nine feet to eight feet; reduced number of parking spaces from six to five parking spaces; a reduced lot area from 10,000 square feet to 7,788 square feet; and reduced minimum side yard from five feet to three feet; and
- c) On Parcel C: reduced width of parking spaces from nine feet to eight feet wide; reduced minimum lot width from 50 feet to 33 feet wide; reduced lot area from 6,000 square feet to 3,267 square feet; reduced maximum side yard from 6.6 feet to six feet, and reduced minimum side yard for a two-unit dwelling from five feet to three feet;

Said property being more particularly described as follows:

172-180 N. CENTRAL AVE. (43222), being 0.42± located on the east side of North Central Avenue at the terminus of Merrimac Street, and being more particularly described as follows:

Situated in the County of Franklin, in the State of Ohio and in the City of Columbus:

Being part of Lot Number Fifty (50) and all of Lots Fifty-One (51), Fifty-Two (52) and Fifty-Three (53) of THOMAS H. KNAUSS'S AMENDED SUBDIVISION of Lot No. 6 of WILLIAMS SULLIVANT'S ESTATE as said lot are numbered and delineated upon the recorded plat thereof, of record in Plat Book 4, Pages 268, Recorder's Office, Franklin County, Ohio, said Part of Lot No. Fifty (50) being more particularly described as follows:

Beginning at a point where the north line of said Lot No. Fifty (50) intersects Central Avenue; thence east along the north line of said Lot 150 feet to the west line of and alley; thence South along said west line of said alley, 30 feet to a point then west on a line parallel with said north line to the east line of said North Central Avenue; thence 30 feet along said east line of said North Central Avenue to the place of beginning.

Parcel number: 010-027601-00

SECTION 2. That this ordinance is conditioned on and shall remain in effect only for so long as said property is used for mixed-use development as demonstrated with the submitted site plan, or those uses permitted in the R-4, Residential District.

SECTION 3. That this ordinance is further conditioned on the subject site being developed in general conformance with the site plan titled, "**SITE PLAN**," dated July 12, 2023, and signed by David B. Perry, Agent for the Applicant and Donald Plank, Attorney for the Applicant. The plans may be slightly adjusted to reflect engineering, topographical, or other site data developed at the time of the development and when engineering and architectural drawings are completed. Any slight adjustments to the plans shall be subject to review and approval by the Director of the Department Building and Zoning Services, or a designee, upon submission of the appropriate data regarding the proposed adjustment.

SECTION 4. That this ordinance is further conditioned upon the review and approval of vehicular access from N. Central Avenue to the overhead door on the west end of the building on Parcel A by the Public Service Department, Division of Traffic Management, if use of the overhead door is proposed in conjunction with a specific use of the building.

SECTION 5. That this ordinance is further conditioned on the applicant obtaining all applicable permits and Certificates of Occupancy for the proposed uses.

SECTION 6. That this ordinance shall take effect and be in force from and after the earliest period allowed by law.

Legislation Number: 2210-2023

Drafting Date: 7/13/2023

Version: 1

Current Status: Passed

Matter Type: Ordinance

Rezoning Application: Z23-024

APPLICANT: Metro Development LLC; c/o Jeffery L. Brown, Atty.: Smith and Hale; 37 West Broad Street, Suite 460; Columbus, OH 43215.

PROPOSED USE: Multi-unit residential development.

DEVELOPMENT COMMISSION RECOMMENDATION: Approval (5-0) on June 8, 2023.

WESTLAND AREA COMMISSION RECOMMENDATION: Approval.

CITY DEPARTMENTS' RECOMMENDATION: Approval. The 6.38± acre site consists of one parcel developed with a single-unit dwelling and additional accessory structures, pending annexation into the City of Columbus, after which will be assigned the R, Rural District. The requested L-AR-1, Limited Apartment Residential District will permit a multi-unit residential development with a maximum of 130 units, developed in accordance with the submitted site plan and building elevations. The *Westland Area Plan* (1994) land use recommendation for this site is Industrial/Manufacturing. Although inconsistent with this recommendation, the proposed multi-unit residential development is consistent with the prevailing residential development pattern in the surrounding area. A concurrent Council variance (Ordinance #2211-2023; CV23-036) has been filed to reduce the perimeter yard, reduce the required building lines, and increase the maximum detached garage height.

To rezone **4300 ALKIRE RD. (43228)**, being 6.38± acres located on the north side of Alkire Road, 400± feet west side of Demorest Road, **From:** R, Rural District, **To:** L-AR-1, Limited Apartment Residential District (Rezoning #Z23-024).

WHEREAS, application #Z23-024 is on file with the Department of Building and Zoning Services requesting rezoning of 6.38± acres from R, Rural District, to the L-AR-1, Limited Apartment Residential District; and

WHEREAS, the Development Commission recommends approval of said zoning change; and

WHEREAS, the Westland Area Commission recommends approval of said zoning change; and

WHEREAS, the City Departments recommend approval of the zoning change because the requested L-AR-1, Limited Apartment Residential District will permit multi-unit residential development at a density consistent with the area's established residential development pattern; now, therefore:

BE IT ORDAINED BY THE COUNCIL OF THE CITY OF COLUMBUS:

SECTION 1. That the Official Zoning Map of the City of Columbus, as adopted by Ordinance No. 0179 -03, passed February 24, 2003, and as subsequently amended, is hereby revised by changing the zoning of the

property as follows:

4300 ALKIRE RD. (43228), being 6.38± acres located on the north side of Alkire Road, and west side of Demorest Road, and being more particularly described as follows:

Situated in the State of Ohio, Jackson Township, Franklin County, being part of Survey No. 1389 of the Virginia Military Survey and containing 6.38± acres, said 6.38± acres being out of an original 6.691 acre tract conveyed to Bible Truth Tabernacle of record in Instrument Number 202202220029640, and being more particularly described as follows;

Beginning for reference, at an easterly corner of said Original 6.691 acre tract, being a southwesterly corner of a 8.61 acre tract of land described as being in the southwesterly limited access right-of-way line of Interstate 270 as shown Parcel 22-WL and conveyed to the State of Ohio of record in Deed Book 2951, Page 148 and shown on the O.D.O.T. plans FRA-270-2.43S, and being on the northeasterly corner of a 0.367 acre tract of land as conveyed to County of Franklin in Instrument Number 202302280019063;

Thence **S 65°29'10" W**, with the south line of said Original 6.691 acre tract, the northerly line of said 0.367 acre tract, and along the northerly line of 0.092 acre tract of land conveyed to Edward and Clarice L. Wanek of record in Deed Book 1603, Page 622 and Deed Book 2086, Page 324, **484.55 feet±** to the southwesterly corner of said Original 6.691 acre tract and being northwesterly corner of said 0.092 acre tract and being in the easterly line of a 0.561 acre tract of land conveyed to Jose M. Gonzalez Solano and Carmelina Hernandez Martinez of record in Instrument Number 202110120183685;

Thence **N 01°33'07" E**, along the westerly line of said Original 6.691 acre tract and along the easterly line of said Solano/Martinez tract, **200.00 feet±** to a common corner thereof;

Thence **S 65°28'47" W**, along a southerly line of said Original 6.691 acre tract, along the northerly line of said Solano/Martinez tract and along the northerly line of a second 0.561 acre tract of land conveyed to Kenneth P. and Florence A. Prater of record in Instrument Number 200210040249780, **200.00 feet±** to a southwesterly corner of said Original 6.691 acre tract, to a point at the northwesterly corner of said Prater tract and being in the easterly line of a 10.020 acre tract of land described as Parcel 2 and conveyed to Alkire Investments Holdings, LLC of record in Instrument Number 202209210134357;

Thence **N 00°38'58" E**, along the westerly line of said Original 6.691 acre tract and the easterly line of said Parcel 2, **816.90 feet±** to a point being a common corner thereof and returning to said 8.61 acre tract and said southwesterly limited access right-of-way line;

Thence along the northeasterly line of said Original 6.691 acre tract and along said southwesterly limited access right-of-way, the following two courses;

S 39°48'23" E, 687.33 feet± to an angle point;

S 39°23'50" E, 264.90 feet± to the **True Point of Beginning**, containing **6.38± acres** more or less.

Property Parcel: 160-000220

Property Address: 4300 Alkire Rd., Columbus, OH (43228).

To Rezone From: R, Rural District,

To: L-AR-1, Limited Apartment Residential District.

SECTION 2. That a Height District of thirty-five (35) feet is hereby established on the L-AR-1, Limited Apartment Residential District on this property.

SECTION 3. That the Director of the Department of Building and Zoning Services be, and is hereby authorized and directed to make the said change on the said original zoning map and shall register a copy of the approved L-AR-1, Limited Apartment Residential District and Application among the records of the Department of Building and Zoning Services as required by Section 3370.03 of the Columbus City Codes; said site plan titled, “**SITE PLAN**,” dated July 11, 2023, said building elevations titled, “**ELEVATIONS SHEETS 1 -5**,” dated June 13, 2023, and said text titled, “**LIMITATION TEXT**,” dated July 11, 2023, all signed by Jeffery L. Brown, Attorney for the Applicant, the text reading as follows:

LIMITATION TEXT

PROPOSED DISTRICT: L-AR-1, Limited Apartment Residential District

PROPERTY ADDRESS: 4300 Alkire Road

OWNER: Bible Truth Tabernacle

APPLICANT: Metro Development LLC

DATE OF TEXT: 7/11/23

APPLICATION NUMBER: Z23-024

1. INTRODUCTION: The site is on the north side of Alkire Road adjacent to I-270. To the north and east is I-270; to the west is an existing multi-unit residential development and to the south across Alkire Road are single-unit dwellings in the township.

2. PERMITTED USES: Those uses permitted in Section 3333.02, AR-12, ARLD and AR-1 Apartment Residential District use of the Columbus City Code.

3. DEVELOPMENT STANDARDS: Unless otherwise indicated in the submitted text or drawings the applicable development standards are contained in Chapter 3333 of the Columbus City Code

A. Density, Lot, and/or Setback Commitments.

1. The maximum number of dwelling units shall be 130.
2. The building setback line along I-270 is reduced from 25 to 5 feet; from Alkire Road from 50 to 15 feet for the hot box / water vault (see CV23-036).
3. The perimeter yard along the west property line is reduced from 25 to 15 feet (see CV23-036).
4. The height of the garages is increased from 15 to 16 feet (see CV23-036).

B. Access, Loading, Parking, and/or Other Traffic Related Commitments.

1. The developer shall install a five foot wide sidewalk along its Alkire Road frontage.
2. The developer shall bring its frontage of Alkire Road up to current County standards of an 11 foot travel lane and a 5 foot paved shoulder on its side of Alkire Road. This improvement shall include a full width mill

and overlay.

3. The developer shall install a 175 foot long eastbound left turn lane on Alkire Road at the entrance to the site.

4. Final access location to Alkire Road is subject to Franklin County Engineer's Office field verification of available sight distance that will occur once vegetation is removed from sight triangles.

C. Buffering, Landscaping, Open Space, and/or Screening Commitments.

1. The SCPZ (Stream Corridor Protection Zone) is shown on the submitted site plan.

2. The applicant is committing to the landscaping shown along the west side of the site and along Alkire Road.

D. Building Design and/or Interior-Exterior Treatment Commitments.

The buildings shall be constructed in accordance with the submitted building elevations. The building elevations may be slightly adjusted to reflect engineering, topographical, or other site data developed at the time of the development plan and when engineering and architectural drawings are completed. Any slight adjustments to the building elevations shall be subject to review and approval by the Director of the Department of Building and Zoning Services, or a designee, upon submission of the appropriate data regarding proposed adjustment.

E. Lighting, Outdoor Display Areas, and/or other Environmental Commitments.

N/A

F. Graphics and/or Signage Commitments.

All graphics and signage shall comply with the Graphics Code, Article 15, Title 33 of the Columbus City Code as it applies to the AR-1 zoning classification and any variance to those requirements will be submitted to the Columbus Graphics Commission for consideration.

G. Miscellaneous Commitments.

Site Plan Revision Allowance. The Property shall be developed in accordance with the Site Plan; however, the Site Plan may be slightly adjusted to reflect engineering, topographical, or other site data established at the time of development and engineering plans are completed. The Director of the Department Building and Zoning Services or the Director's designee may approve any slight adjustment to the Site Plan upon submission of the appropriate data regarding the proposed adjustment.

SECTION 4. That this ordinance shall take effect and be in force from and after the earliest period allowed by law.

Legislation Number: 2211-2023

Drafting Date: 7/13/2023

Version: 1

Current Status: Passed

Matter Type: Ordinance

Council Variance Application: CV23-036

APPLICANT: Metro Development LLC; c/o Jeffery L. Brown, Atty.: Smith and Hale; 37 West Broad Street, Suite 460; Columbus, OH 43215.

PROPOSED USE: Multi-unit residential development.

WESTLAND AREA COMMISSION RECOMMENDATION: Approval.

CITY DEPARTMENTS' RECOMMENDATION: Approval. The applicant has received a recommendation of approval from Staff and the Development Commission for a concurrent rezoning (Ordinance #2210-2023; Z23-024) to the L-AR-1, Limited Apartment Residential District for a multi-unit residential development containing up to 130 units. The requested Council variance permits reduced building lines, reduced perimeter yard, and increased height of detached garages for a proposed apartment complex. The requested building line and perimeter yard reductions are supported noting the irregular shape of the site, and the presence of two stream corridor protection zones on site. The increased height for the detached garage buildings allows for a pitched roof design that is consistent with the proposed apartment buildings. The proposal is consistent with the surrounding zoning and residential development pattern along Alkire Road, and with *Columbus Citywide Planning Policies (C2P2) Design Guidelines (2018)*

To grant a Variance from the provisions of Sections 3333.18, Building lines; 3333.255, Perimeter yard; and 3333.35(G), Private garage, of the Columbus City Codes; for the property located at **4300 ALKIRE RD. (43228)**, to permit reduced development standards for an apartment complex in the L-AR-1, Limited Apartment Residential District (Council Variance #CV23-036).

WHEREAS, by application #CV23-036, the owner of property at **4300 ALKIRE RD. (43228)**, is requesting a Council variance to permit reduced development standards for an apartment complex in the L-AR-1, Limited Apartment Residential District; and

WHEREAS, Section 3333.18, Building lines, requires building lines of 25 feet along I-270, and 50 feet along Alkire Road, while the applicant proposes a reduced building lines of 5 feet along the east property line (the I-270 frontage) and of 15 feet along Alkire Road; and

WHEREAS, Section 3333.255, Perimeter yard, requires a 25-foot wide perimeter yard for an apartment complex, while the applicant proposes a reduced perimeter yard of 15 feet along the western property line; and

WHEREAS, Section 3333.35(G), Private garage, restricts the height of a private detached garage building to 15 feet, while the applicant proposes to increase the permitted height to 16 feet; and

WHEREAS, the Westland Area Commission recommends approval; and

WHEREAS, the City Departments recommend approval of the requested variances because of the irregular shape of the site, the presence of stream corridor protection zones, and the design of the detached garage buildings which will be more consistent with the roof pitch of the proposed apartment buildings. The proposal is consistent with the surrounding zoning and residential development pattern along Alkire Road, and with C2P2 Design Guidelines; and

WHEREAS, this ordinance requires separate submission for all applicable permits and Certificates of

Occupancy for the proposed use; and

WHEREAS, said variance will not seriously affect the surrounding property or surrounding neighborhood; and

WHEREAS, the granting of said variance will not impair an adequate supply of light and air to adjacent properties or unreasonably increase the congestion of public streets, or unreasonably diminish or impair established property values within the surrounding area, or otherwise impair the public health, safety, comfort, morals, or welfare of the inhabitants of the City of Columbus; and

WHEREAS, the granting of said variance will alleviate the difficulties encountered by the owners of the property located at **4300 ALKIRE RD. (43228)**, in using said property as desired; now, therefore:

BE IT ORDAINED BY THE COUNCIL OF THE CITY OF COLUMBUS:

SECTION 1. That a variance from the provisions of Sections 3333.18, Building lines; 3333.255, Perimeter yard; and 3333.35(G), Private garage, of the Columbus City Codes, is hereby granted for the property located at **4300 ALKIRE RD. (43228)**, insofar as said sections prohibit reduced building lines from 25 feet along I-270 and 50 feet along Alkire Road to 5 and 15 feet, respectively; a reduced perimeter yard from 25 to 15 feet along the western property line; and an increased private detached garage height from 15 to 16 feet; said property being more particularly described as follows:

4300 ALKIRE RD. (43228), being 6.38± acres located on the north side of Alkire Road, 400± feet west of I-270, and being more particularly described as follows:

Situated in the State of Ohio, Jackson Township, Franklin County, being part of Survey No. 1389 of the Virginia Military Survey and containing 6.38± acres, said 6.38± acres being out of an original 6.691 acre tract conveyed to Bible Truth Tabernacle of record in Instrument Number 202202220029640, and being more particularly described as follows;

Beginning for reference, at an easterly corner of said Original 6.691 acre tract, being a southwesterly corner of a 8.61 acre tract of land described as being in the southwesterly limited access right-of-way line of Interstate 270 as shown Parcel 22-WL and conveyed to the State of Ohio of record in Deed Book 2951, Page 148 and shown on the O.D.O.T. plans FRA-270-2.43S, and being on the northeasterly corner of a 0.367 acre tract of land as conveyed to County of Franklin in Instrument Number 202302280019063;

Thence **S 65°29'10" W**, with the south line of said Original 6.691 acre tract, the northerly line of said 0.367 acre tract, and along the northerly line of 0.092 acre tract of land conveyed to Edward and Clarice L. Wanek of record in Deed Book 1603, Page 622 and Deed Book 2086, Page 324, **484.55 feet±** to the southwesterly corner of said Original 6.691 acre tract and being northwesterly corner of said 0.092 acre tract and being in the easterly line of a 0.561 acre tract of land conveyed to Jose M. Gonzalez Solano and Carmelina Hernandez Martinez of record in Instrument Number 202110120183685;

Thence **N 01°33'07" E**, along the westerly line of said Original 6.691 acre tract and along the easterly line of said Solano/Martinez tract, **200.00 feet±** to a common corner thereof;

Thence **S 65°28'47" W**, along a southerly line of said Original 6.691 acre tract, along the northerly line of said Solano/Martinez tract and along the northerly line of a second 0.561 acre tract of land conveyed to Kenneth P. and Florence A. Prater of record in Instrument Number 200210040249780, **200.00 feet±** to a southwesterly

corner of said Original 6.691 acre tract, to a point at the northwesterly corner of said Prater tract and being in the easterly line of a 10.020 acre tract of land described as Parcel 2 and conveyed to Alkire Investments Holdings, LLC of record in Instrument Number 202209210134357;

Thence N **00°38'58"** E, along the westerly line of said Original 6.691 acre tract and the easterly line of said Parcel 2, **816.90 feet±** to a point being a common corner thereof and returning to said 8.61 acre tract and said southwesterly limited access right-of-way line;

Thence along the northeasterly line of said Original 6.691 acre tract and along said southwesterly limited access right-of-way, the following two courses;

S **39°48'23"** E, **687.33 feet±** to an angle point;

S **39°23'50"** E, **264.90 feet±** to the **True Point of Beginning**, containing **6.38± acres** more or less.

Property Parcel: 160-000220

Property Address: 4300 Alkire Rd., Columbus, OH (43228).

SECTION 2. That this ordinance is conditioned on and shall remain in effect only for so long as said property is used for those uses permitted in the L-AR-1, Limited Apartment Residential District, specified by Ordinance #2210-2023; Z23-034.

SECTION 3. That this ordinance is further conditioned on the applicant obtaining all applicable permits and Certificates of Occupancy for the proposed use.

SECTION 4. That this ordinance shall take effect and be in force from and after the earliest period allowed by law.

Legislation Number: 2212-2023

Drafting Date: 7/13/2023

Current Status: Passed

Version: 1

Matter Type: Ordinance

To authorize the Director of the Department of Neighborhoods to enter into grant agreements with the following not-for-profit agencies in support of summer youth employment and programs: Liberians in Columbus Inc.; to authorize the transfer, appropriation and expenditure of \$50,000.00 within the general fund; to authorize the payment of expenses starting May 22, 2023; and to declare an emergency. (\$50,000.00)

WHEREAS, The Mayor and City Council are committed to the mission and work of the My Brother's Keeper and the Commission on Black Girls; and,

WHEREAS, the grant funding of \$50,000.00 by passage of this ordinance will be used to support not-for-profit agencies to provide support youth employment and programming; and

WHEREAS, such expenditure of funds has not been previously accounted for within the 2023 Budget; and

WHEREAS, an emergency exists in the usual daily operation of the Department of Neighborhoods in that it is immediately necessary to authorize the Director to enter into grant agreements to allow the agencies to immediately provide summer employment opportunities for the remainder of the summer recess; **NOW,**

THEREFORE,

BE IT ORDAINED BY THE COUNCIL OF THE CITY OF COLUMBUS:

SECTION 1: That the Director of the Department of Neighborhoods is authorized to enter into a non-profit grant agreement with the following agency:

Liberians in Columbus Inc., \$50,000.00

SECTION 2: That the expenditure of funds for food and transportation is hereby determined to be a valid public purpose.

SECTION 3: That the transfer and appropriation of \$50,000.00, or so much thereof as may be needed is hereby authorized within the General Fund 1000, per the accounting codes in the attachment to this ordinance

SECTION 4: That the expenditure of \$50,000.00 or so much thereof as may be needed is authorized in Fund 1000, Dept-Div 48-01, in object class 05 (Grants) per the accounting codes in the attachment to this ordinance.

SECTION 5: That the funds necessary to carry out the purpose of this ordinance are deemed appropriated, and the City Auditor shall establish such accounting codes as necessary.

SECTION 6: That the City Auditor is authorized to make any accounting changes to revise the funding source for all contracts or contract modifications associated with this legislation.

SECTION 7: That for reasons stated in the preamble hereto, which is hereby made a part hereof, this ordinance is declared to be an emergency measure and shall take effect and be in force from and after its passage and approval by the Mayor, or ten days after passage if the Mayor neither approves nor vetoes the same.

Legislation Number: 2213-2023

Drafting Date: 7/13/2023

Current Status: Passed

Version: 1

Matter Type: Ordinance

Ordinance 1585-2023 authorized the City Auditor to transfer and appropriation of \$1,747,761.00 from the Department of Finance and Management General Fund 1000 to the Department of Neighborhoods General Fund 1000 and authorizes the Director of the Department of Neighborhoods to enter into a service agreement with various not-for-profit agencies, for the purposes of providing summer youth employment and programming.

This ordinance will modify Ordinance 1585-2023 passed on May 22, 2023 to correct the organization name originally listed as Ohio Black Dance to OhioDance on behalf of Ohio Black Dance and authorize the Director of the Department of Neighborhoods to enter into a service agreement with the not-for-profit agency OhioDance on behalf of Ohio Black Dance.

Emergency Designation: Emergency action is requested as programming is currently underway and to ensure students can continue to benefit from the summer employment opportunity.

Fiscal Impact: This legislation does not have a fiscal impact.

CONTRACT COMPLIANCE: the vendor numbers is:

OhioDance 045834 and is valid 6/26/2023 - 6/26/2025

This ordinance will modify Ordinance 1585-2023 passed on May 22, 2023 to correct the organization name originally listed as Ohio Black Dance to OhioDance on behalf of Ohio Black Dance and authorize the Director of the Department of Neighborhoods to enter into a service agreement with the not-for-profit agency OhioDance on behalf of Ohio Black Dance; and to declare an emergency.

WHEREAS, The Mayor and City Council are committed to the mission and work of the My Brother’s Keeper and the Commission on Black Girls; and,

WHEREAS, there is a need to ensure funds are awarded to appropriate agency name; and

WHEREAS, this ordinance is submitted as an emergency so as to allow the financial transactions to be posted in the City's accounting system as soon as possible, promoting accurate accounting and financial management; and

WHEREAS, an emergency exists in the usual daily operation of the Department of Neighborhoods in that it is immediately necessary to authorize the Director to enter into grant agreement to allow the agencies to immediately provide summer employment opportunities;

NOW, THEREFORE, BE IT ORDAINED BY THE COUNCIL OF THE CITY OF COLUMBUS:

SECTION 1: This ordinance will modify Ordinance 1585-2023 passed on May 22, 2023 to correct the organization name originally listed as Ohio Black Dance to OhioDance on behalf of Ohio Black Dance.

SECTION 2: That the Director of the Department of Neighborhoods is authorized to enter into a non-profit grant agreement with OhioDance on behalf of Ohio Black Dance.

SECTION 3: That for reasons stated in the preamble hereto, which is hereby made a part hereof, this ordinance is declared to be an emergency measure and shall take effect and be in force from and after its passage and approval by the Mayor, or ten days after passage if the Mayor neither approves nor vetoes the same.

Legislation Number: 2214-2023

Drafting Date: 7/13/2023

Current Status: Passed

Version: 1

Matter Type: Ordinance

This ordinance will modify Ordinance 1582-2023 passed on May 22, 2023 to correct the organization name originally listed as Legacy Youth Academy to Legacy Youth Sports Academy and authorize the Director of the Department of Neighborhoods to enter into a service agreement with the not-for-profit agency Legacy Youth Sports Academy.

Emergency Designation: Emergency action is requested as programming is currently underway and to ensure students can continue to benefit from the summer employment opportunity.

Fiscal Impact: This legislation does not have a fiscal impact.

CONTRACT COMPLIANCE: the vendor numbers is:

Legacy Youth Sports Academy 032983 and is valid 5/30/2023 - 5/30/2025

This ordinance will modify Ordinance 1582-2023 passed on May 22, 2023 to correct the organization name originally listed as Legacy Youth Academy to Legacy Youth Sports Academy and authorize the Director of the Department of Neighborhoods to enter into a service agreement with the not-for-profit agency Legacy Youth Sports Academy; and to declare and emergency.

WHEREAS, there is a need to ensure funds are awarded to appropriate agency name; and

WHEREAS, this ordinance is submitted as an emergency so as to allow the financial transactions to be posted in the City's accounting system as soon as possible, promoting accurate accounting and financial management; and

WHEREAS, an emergency exists in the usual daily operation of the Department of Neighborhoods in that it is

immediately necessary to authorize the Director to enter into grant agreement to allow the agencies to immediately provide summer employment opportunities;

NOW, THEREFORE, BE IT ORDAINED BY THE COUNCIL OF THE CITY OF COLUMBUS:

SECTION 1: This ordinance will modify Ordinance 1582-2023 passed on May 22, 2023 to correct the organization name originally listed as Legacy Youth Academy to Legacy Youth Sports Academy.

SECTION 2: That the Director of the Department of Neighborhoods is authorized to enter into a non-profit grant agreement with Legacy Youth Sports Academy.

SECTION 3: That for reasons stated in the preamble hereto, which is hereby made a part hereof, this ordinance is declared to be an emergency measure and shall take effect and be in force from and after its passage and approval by the Mayor, or ten days after passage if the Mayor neither approves nor vetoes the same.

Legislation Number: 2215-2023

Drafting Date: 7/14/2023

Version: 1

Current Status: Passed

Matter Type: Ordinance

Rezoning Application: Z23-004

APPLICANT: Strait Real Estate & Arnold Lumber Investments II LLC; c/o Thomas Hart, Atty.; 5029 Cemetery Road; Hilliard, OH 43206.

PROPOSED USE: Light manufacturing and lumber yard.

DEVELOPMENT COMMISSION RECOMMENDATION: Approval (4-0) on June 8, 2023.

GREATER SOUTH EAST AREA COMMISSION RECOMMENDATION: Approval.

CITY DEPARTMENTS' RECOMMENDATION: Approval. The 27.56± acre site consists of two parcels located on the north side of Winchester Pike zoned in the R, Rural District. The larger 15.77± acre parcel is developed with a manufacturing facility specializing in lumber products, and is partially located within the flood plain, while the smaller 11.79± acre parcel is undeveloped. The requested L-M, Limited Manufacturing District will permit the expansion of the existing manufacturing use. The limitation text divides the site into Subarea A, the existing development, and Subarea B, the proposed expansion. The plan proposes an additional warehouse, an outdoor storage area, and two additional sheds in Subarea B. The text establishes use restrictions and supplemental development standards that address building, parking, storage, and landscaping setbacks, traffic access, landscaping and screening, dumpsters, and graphics provisions. The text also contains additional traffic commitments for reducing the existing driveway access for Subarea A along Winchester Pike, and upgrading the north side of Winchester Pike to meet the Franklin County Engineers Office's standards for travel lane width and shoulder grading along the frontage of the site. The site is located within the planning boundaries of the *South East Land Use Plan* (2018), which recommends "Industrial/Warehouse" land uses at this location for the existing manufacturing use (Subarea A), and recommends "Employment

Center” for the proposed expansion area (Subarea B). The Plan also includes the complete adoption of *Columbus Citywide Planning Policies (C2P2) Design Guidelines (2018)*. Staff supports the requested L-M district as the permitted uses are consistent with both land use recommendations at this location, and the limitation text commitments for landscaping, screening, and fencing will adequately buffer and screen adjacent residential uses from these non-residential uses, consistent with C2P2 design guidelines. The request also incorporates traffic-related improvements which are supported by both the Department of Public Service and the Franklin County Engineers Office. A concurrent Council variance (Ordinance #2216-2023; CV23-010) has been filed and includes variances to allow more objectionable uses within 600 feet of a residentially zoned property, with reduced standards for parking surface, dumpster area, storage, and building setbacks.

To rezone **5200 WINCHESTER PIKE (43110)**, being 27.56± acres located on the north side of Winchester Pike, 1,650± feet east of Shannon Road, **From:** R, Rural District, **To:** L-M, Limited Manufacturing District (Rezoning #Z23-004).

WHEREAS, application #Z23-004 is on file with the Department of Building and Zoning Services requesting rezoning of 27.56± acres from R, Rural District, To: L-M, Limited Manufacturing District; and

WHEREAS, the Development Commission recommends approval of said zoning change; and

WHEREAS, the Greater South East Area Commission recommends approval of said zoning change; and

WHEREAS, the City Departments recommend approval of said zoning change because the requested L-M, Limited Manufacturing District will permit the expansion of an existing manufacturing use that includes commitments for landscaping, screening, traffic access, and improvements, all consistent with the land use recommendations of the *South East Land Use Plan and C2P2 Design Guidelines*; now, therefore:

BE IT ORDAINED BY THE COUNCIL OF THE CITY OF COLUMBUS:

SECTION 1. That the Official Zoning Map of the City of Columbus, as adopted by Ordinance No. 0179 -03, passed February 24, 2003, and as subsequently amended, is hereby revised by changing the zoning of the property as follows:

5200 WINCHESTER PIKE (43110), being 27.56± acres located on the north side of Winchester Pike, 1,650± feet east of Shannon Road , and being more particularly described as follows:

Parcel 1 (Subarea A):

Situated in the State of Ohio, County of Franklin, Township of Madison, lying in Section 10, Township 11, Range 21, and being a 15.759 acre tract conveyed to Strait Real Estate LLC 1 LTD by Instrument Number 199705230006729, records of the Recorder’s Office, Franklin County, Ohio, and being more particularly described as follows:

Commencing at a Franklin County Monument #9946 at the southeast corner of said Section 10, southwest corner of Section 11, northwest corner of Section 14, and the northeast corner of Section 15, and the southwesterly corner of a 11.904 acre tract as conveyed to Arnold Estate Investments II LLC by Instrument Number 202110270195617;

Thence northerly along the east line of section 10, the west line of Section 11, and a 40.76 acre tract as conveyed to Ohio Lamb Farm LLC., in Instrument Number 201509170131006, **North 4°20’08” West, 722.51 feet**, to a point being the northeasterly corner of said 11.904 acre tract, and being the **Point of Beginning** for the herein described 15.900 acre tract;

Thence along the northerly line of said 11.904 acre tract, **North 84°45'24" West, 746.10 feet** to a Pipe Found, being a northeasterly corner of a 0.815 acre tract as conveyed to Stephen M. Forquer and Amy J. Forquer by Official Record 11460, Page F19;

Thence along the northerly line of said 0.815 acre tract, **North 84°45'38" West, 219.94 feet** to a point, being the northwesterly corner of a 1.469 acre tract as conveyed to Stephen M. Forquer and Amy J. Forquer by Official Record 11460, Page F19;

Thence along the westerly line of said 1.469 acre tract, **South 4°09'07" West, 403.06 feet** to a point in the southerly right-of-way of Winchester Pike;

Thence along the southerly right-of-way of said Winchester Pike, **North 47°29'41" West, 255.66 feet** to a point;

Thence **North 4°18'31" East, 744.60 feet** to an Iron Pipe Found, being the southwest corner of a 25.588 acre tract as conveyed to Trailway Resources LLC in Instrument Number 201909120118306;

Thence along the southerly line of said 25.588 acre tract the following two (2) courses:

South 84°55'52" East, 349.58 feet to an Iron Pipe Found;

Thence **North 87°05'14" East, 822.99 feet** to an Iron Pipe Found, being the northwesterly corner of said 40.76 acre tract;

Thence along the westerly line of said 40.76 acre tract, **South 4°20'08" West, 614.18 feet** to the **POINT OF BEGINNING**. Containing **15.900 acres**, more or less, and being subject to all easements, restrictions, and rights-of-way of record.

The bearings in the above description were based on the bearings of N 85°04'48" W, for the southerly line of Section 11 as shown of record in O.R. 20944 A15.

Subject to all valid and existing easements, restrictions and conditions of record.

Address: 5200 Winchester Pike, Columbus, OH 43110

PIN: 535-307599

Parcel 2 (Subarea B):

Situated in the State of Ohio, County of Franklin, Township of Madison, lying in Section 10, Township 11, Range 21, and being a 11.904 acre tract as conveyed to Arnold Estate Investments II LLC by Instrument Number 202110270195617, records of the Recorder's Office, Franklin County, Ohio, and being more particularly described as follows:

BEGINNING at a Franklin County Monument #9946 at the southeast corner of said Section 10, southwest corner of Section 11, northwest corner of Section 14, and the northeast corner of Section 15;

Thence along the southerly line of Section 10, **North 86°08'49" West, 437.03 feet** to an Iron Pipe Found, being a point in the northerly right-of-way line of Winchester Pike as conveyed to Franklin County Commissioners in Instrument Number 202112210230334;

Thence along the northerly right-of-way line of said Winchester Pike, **North 47°29'41" West, 392.72 feet** to a Pipe Found, being the southeasterly corner of a 0.815 acre tract as conveyed to Stephen M. Forquer and Amy J. Forquer by Official Record 11460, Page F19;

Thence **North 4°18'29" East, 495.31 feet** to a Pipe Found, being the northeasterly corner of said 0.815 acre tract, also being a point in the southerly line of a 15.77 acre tract as conveyed to Strait Real Estate LLC 1 LTD

by Instrument Number 199705230006729;

Thence along the southerly line of said 15.77 acre tract, **South 84°45'24" East, 746.10 feet** to a point, being a point in the easterly line of said Section 10 and the westerly line of said Section 11;

Thence along the easterly line of said Section 10, **South 4°20'08" West, 722.51 feet** to the **POINT OF BEGINNING**. Containing **11.657 acres**, more or less, and being subject to all easements, restrictions, and rights-of-way of record.

The bearings in the above description were based on the bearings of N 85°04'48" W, for the southerly line of Section 11 as shown of record in O.R. 20944 A15.

Subject to all valid and existing easements, restrictions and conditions of record.

Address: 5200 Winchester Pike, Columbus, OH 43110

PIN: 535-307599

To Rezone From: R, Rural District,

To: L-M, Limited Manufacturing District.

SECTION 2. That a Height District of thirty-five (35) feet is hereby established on the L-M, Limited Manufacturing District on this property.

SECTION 3. That the Director of the Department of Building and Zoning Services be, and is hereby authorized and directed to make the said change on the said original zoning map and shall register a copy of the approved L-M, Limited Manufacturing District and Application among the records of the Department of Building and Zoning Services as required by Section 3370.03 of the Columbus City Codes; said plans titled "**SUBAREA A LAYOUT**," "**SUBAREA B LAYOUT**," and "**LANDSCAPE PLAN**," all dated July 13, 2023, signed by Thomas Hart, Attorney for the Applicant, and text titled, "**LIMITATION TEXT**," dated July 13, 2023, and signed by Thomas Hart, Attorney for the Applicant, and the text reading as follows:

LIMITATION TEXT

Property Location: 5200 Winchester Pike, Canal Winchester, OH 43110

Parcel Nos: 535-307599 (Subarea A - 15.7587+/- acres) and 535-307600 (Subarea B - 11.655+/- acres)

Owners: Strait Real Estate LLC, 1 Ltd. and Arnold Estate Investments II LLC

Applicants: Strait Real Estate LLC, 1 Ltd. and Arnold Estate Investments II LLC

Proposed District: L-M, Limited Manufacturing with M district and office uses

Date of Text: 7-13-2023

Application No.: Z23-004

I. INTRODUCTION:

The subject property consists of 27.4137+/- acres (the "Site") located at 5200 Winchester Pike, west of Brice Road and south of Shannon Road. The property is made up of two parcels that were previously zoned Planned Industrial Park (15.7587 acres, PN 535-307599) and Rural (11.655 acres, PN 535-307600) respectively in Madison Township. Both parcels were recently annexed into the City of Columbus to facilitate utility service and expansion. The site is surrounded by farmland on the east and west sides and residential land on the north and vacant land on the south, along with several single-family residences on the south border and between the

two parcels.

The applicant proposes to rezone the site to one cohesive Limited-Manufacturing district, (L-M) with two subareas. The applicants plan to combine the two existing parcels with consolidated ownership in the future. Until this parcel and ownership consolidation occurs, and/or unless it does not occur before final site plan approval, the applicants will establish cross-access and reciprocal utility easements meeting city requirements and with city approval to operate as a uniform site. Draft reciprocal easements are attached with this application, and are to be finalized upon rezoning approval and final site plan compliance. Permitted uses for both subareas include those under the Manufacturing (M) district classification, along with existing and expanded related office uses. This will allow for the continuation and expansion of an existing lumber truss and wall systems production facility to supply the regional home building and commercial construction industries. The applicant's existing business and expansion of the current facility and its annexation to Columbus will provide job growth and revenue to the City.

So long as the business operation on the site are lumber truss and wall systems production and office facilities, the site will be developed in a manner that is generally consistent with the Zoning Compliance and Commitment Plans titled "Subareas A Layout", "Subarea B Layout" and "Landscaping Plans" attached hereto. Illustrative and Conceptual Zoning Plans are also attached to show likely development details but these Plans are subject to adjustment consistent with this governing text before they are finally approved through the final site compliance process.

II. PERMITTED USES:

- A. Uses under Sections 3363.02 through 3363.08 (less objectionable uses) and 3363.12 (more objectionable uses) under the M designation, Manufacturing and Warehousing and Office Uses in both subareas.
- B. Those more objectionable uses from Section 3363.12, shall include but may not be limited to the permitted uses of planning, millwork, sawmill and other wood component manufacturing, such as wall panel systems, trusses and joists for roofs and floor systems and assembly, outdoor storage of materials, finished wood components, and shipping from outdoor storage locations. Such uses under Section 3363.12 are conditioned upon and only permitted so long as the existing lumber manufacturing facility is in business operation.
- C. Outdoor materials storage areas as generally depicted on Zoning Compliance and Commitment Plans.
- D. And, upon re-development, permitted uses include the allowance for those uses as generally permitted in C-1, C-2, C-3 and C-4 commercial districts, *except* those uses listed below, which are specifically excluded on this site:

- Animal Shelter
- Bar
- Blood and Organ Banks
- Cabarets and Nightclubs
- Check Cashing and Loans

Extended Stay Hotel

Halfway House

Mission/Temporary Shelters

Sales, Rental, Leasing of Automobiles, Motorcycles, Boats, Recreational Vehicles, Utility Trailers, Off-road vehicles and/or Trucks

Pawn Brokers

Other uses that are specifically prohibited: Adult Entertainment, Adult Store

III. DEVELOPMENT STANDARDS:

Unless otherwise indicated in this limitation text and/or on the submitted site plans and zoning exhibits, the applicable development standards contained in Chapter 3363, M-Manufacturing District with provision for related office uses and/or upon re-development, Chapter 3356, C-4, Commercial District, of the Columbus City Code shall apply. See also Concurrent CV23-010 for reduced development standards related to this development.

A. Subarea Standards

Subarea A

1. Existing Buildings and Conditions Subarea A are approved for up to 92,800 square feet of manufacturing, warehousing and related office space in the general configurations depicted on Illustrative and Conceptual Zoning Plans.

Expansion of the current buildings as shown on Illustrative and Conceptual Zoning Plans or as provided herein shall require all applicable regulatory and code compliance updates, and the approval of Final Site Compliance Plans, as well as rezoning if applicable.

2. Setbacks: Building, pavement/parking and material storage setbacks shall be as depicted on the site plan titled, "Subarea A Layout". Note: The pavement/parking setback at Winchester Pike is 0 (zero) feet for Subarea A based on right-of-way dedication requirements and existing conditions. This setback is requested for variance in the accompanying Council Variance application, CV23-010.

3. Height - Up to 35 ft with allowance for graduation of building heights.

Subarea B

1. Buildings to be constructed in Subarea B are approved for up to 108,000 square feet of manufacturing, warehousing and related office space in the general building configurations as depicted on Illustrative and Conceptual Zoning Plans. The building locations depicted on the Subarea B Layout plans may be adjusted based on site conditions and final engineering.

Expansion of the buildings or overall square footage referenced above or as provided herein shall require all

applicable regulatory and code compliance updates, and the approval of Final Site Compliance Plans, as well as rezoning if applicable.

2. Building Setbacks Subarea B

a. Winchester Pike: Minimum 60 feet

3. Pavement/Parking Setbacks (landscape buffers) Subarea B

a. West - 20 ft minimum

b. East - 20 ft minimum

c. South - 20 ft minimum

d. North - 0 ft from Subarea A

e. Winchester Pike: 25 minimum

4. Material Storage Setbacks Subarea B

a. West - 100 ft minimum

b. East - 100 ft minimum

c. North - 25 ft minimum from Subarea A unless these parcels are combined.

d. South - 100 ft minimum

e. Winchester Pike: 30 ft minimum

6. Height - Up to 35 ft with allowance for graduation of building heights.

B. Access, Loading, Parking and/or Other Traffic Related Commitments

1. Two accesses shall be maintained via curb cuts from Winchester Pike as shown on the Site Plan for both Subareas.

2. Parking spaces shall comply with code requirements as shown on the submitted site plan(s).

3. Traffic Commitments:

a. Jurisdiction for traffic regulation for Subarea B (new facilities) lies primarily with Franklin County Engineer's Office (FCEO) as access to this portion of Winchester Pike is within County limits. Jurisdiction for traffic regulation for Subarea A (existing facilities) lies primarily with the City of Columbus. A revised Traffic Impact Study (TIS) for the site was completed and submitted to the Franklin County Engineer's Office on July 6, 2022 and shared with the City after the FCEO approved the TIS with requested revisions on July 5, 2022. Approved traffic commitments are as follows:

b. As requested by the City Division of Traffic Management and the FCEO, the width of the existing driveway access at 5200 Winchester Pike (PN 535-307599) for Subarea A will be reduced to the maximum width of 38.22 feet with the reduction of pavement along Winchester Pike. Driveway access for Subarea A is to be reconfigured per Columbus Standard Drawing 2202. The feasibility of providing a shoulder per Columbus

Standard Drawing 2135 and/or leaving existing pavement to function as a shoulder will be determined during final engineering design and as approved by the City. Existing parking spaces are to be relocated from and turf grass will be added to this area as determined at final engineering approval. The reduced access and driveway reconfiguration will be made within six months of the applicants' commencing operations of the newly constructed buildings, including the new warehouse and production buildings as proposed, so that ongoing internal operations are not impacted.

c. The applicant shall be responsible for upgrading the north side of Winchester Pike to meet current FCEO standards for travel lane width and shoulder grading along the frontage of the property. The current standard is for an eleven-foot travel lane, with a five foot paved and graded shoulder. A full-width mill and overlay shall be required along with this widening. These improvements shall be constructed or bonded prior to the Applicant receiving new access approval to Winchester Pike. Alternatively, Franklin County holds the right to require a fee in lieu of this construction to be used towards regional improvements within the Winchester Pike area. If directed by the FCEO, such fee shall be based on an engineer's estimate and schematic of the widening, subject to review and approval of the FCEO. Such fee in lieu shall be requested prior to any improvements by the applicants.

C. Buffering, Landscaping, Open Space and/or Screening Commitments

1. Landscaping commitments are shown on the attached Landscape Plan. Buffering shall include maintaining a minimum 20 feet landscape screen on the east and south sides of Subarea B adjacent to agricultural and residential neighboring properties. (A wider tree preservation area is shown and is to be maintained along the southern property border with neighboring parcel number 181-000152-00.) Existing tree stands are to remain or be removed as indicated on the Landscape Plan. Subarea B landscaping includes the following and named species may be replaced with similar species:

a. To be installed between the sidewalk along Winchester Pike and the parking areas and buildings: Eight (8) 6 foot high Juniper shrubs; Seventeen (17) 18 inch high Dogwood shrubs; Eight (8) American Elm deciduous trees.

b. To be installed along the eastern Subarea B border with parcel number 010-262375-00; Twenty-Nine (29) evergreen trees (Canadian Hemlock).

2. The Forquer parcel (PN 180-000303-00) is screened on its eastern border with Sixteen (16) evergreen trees (Canadian Hemlock) to be installed on the western boundary of Subarea B between the new retention pond and property line.

3. An existing six (6) foot high opaque fence is to be expanded and fully inserted with wood slats to screen the eastern and southern property lines of Subarea A, in relation to the western and northern boundaries of the Forquer parcel (PN 180-000303-00) as depicted on Landscape Plan.

D. Dumpsters, Lighting, Outdoor Display Areas, and/or other Environmental Commitments

1. Trash dumpster enclosure design commitments are as follows: Six (6) foot high chain link fence with gate and slats for screening. The enclosure is built on a concrete slab with a 7 foot concrete approach apron in front of the gate. Dumpster screening may also be revised to comply with Section 3321.01, Dumpster area.
2. A second larger dumpster is designed to handle and transport wood and lumber scraps for recycling off-site as depicted on the Subarea B Layout plan sheet and is the subject of a variance request under CV23-010.
3. Lighting commitment details are to be depicted on building elevations at the time of final site plan compliance.
4. No outdoor displays shall be permitted for this lumber processing/warehouse operation and use.

E. Graphics and Signage Commitments

The applicable graphics standards shall be those contained in the City Code chapter 3377 as they apply to M, Manufacturing District. Any variances to the City Code for Graphics for wall, monument and tenant sign panel signs shall be submitted to the Columbus Graphics Commission and the applicant shall file a graphics plan application for any such signs on this parcel.

F. Miscellaneous Commitments:

1. Please refer to CV23-010 to allow more objectionable uses within 600 feet of residentially zoned property [3311.28(b)], to allow outdoor storage of materials and finished wood components within 25 feet of residentially-zoned property as a variance to section 3363.41(a), to allow parking and maneuvering on hard-parked limestone surfaces (33121.43), to vary section 3312.27(2) to allow a parking/pavement setback of zero feet for Subarea A at Winchester Pike based on right-of-way dedication and existing conditions, to vary building setbacks under section 3363.24, and to allow variance in dumpster standards under 3321.01. A separate application for an administrative variance has been filed with the Division of Traffic Management, Department of Public Service with regard to required right-of-way dedication under section 4309.17 and based on the existing building location in Subarea A.
2. The site shall be developed in general conformance with the submitted Zoning Compliance and Commitments Plans, titled “Subareas A Layout”, “Subarea B Layout” and “Landscaping Plans” attached hereto. The submitted Subareas A and B Layout plans, the building locations depicted within Subarea B and Landscaping Plans may be adjusted to reflect engineering, topographical, changes to buildings and expansions of buildings square footages as referenced in this text based on business needs, structural designs, site conditions or other site data developed at the time of final site compliance, development and/or as engineering plans are completed. Any adjustment to the plans shall be reviewed and may be approved by the Director of the Department of Building and Zoning Services, or a designee, upon submission of the appropriate data regarding the proposed adjustment.

SECTION 4. That this ordinance shall take effect and be in force from and after the earliest period allowed by law.

Legislation Number: 2216-2023

Drafting Date: 7/14/2023

Version: 1

Current Status: Passed

Matter Type: Ordinance

Council Variance Application: CV23-010

APPLICANT: Strait Real Estate & Arnold Lumber Investments II LLC; c/o Thomas Hart, Atty.; 5029 Cemetery Road; Hilliard, OH 43206.

PROPOSED USE: Manufacturing and lumber yard.

GREATER SOUTH EAST AREA COMMISSION RECOMMENDATION: Approval.

CITY DEPARTMENTS' RECOMMENDATION: Approval. The applicant has received a recommendation of approval from Staff and the Development Commission for a concurrent rezoning (Ordinance #2215-2023; Z23-004) to the L-M, Limited Manufacturing District to permit manufacturing uses. The requested variance will permit the expansion of an existing manufacturing lumber yard and will legitimize reductions in distance separation between residential and more objectionable manufacturing uses, and includes standard variances for required parking surface, parking setbacks, dumpster area, building setback lines, and storage area. The request is consistent with other approved variances that have been supported for legitimizing existing manufacturing developments. Additional landscaping and buffering, and traffic access and improvement commitments are included with the rezoning ordinance, and therefore staff is supportive of the requested variances.

To grant a Variance from the provisions of Sections 3311.28(b), More objectionable uses; 3312.27(2), Parking setback line; 3312.43, Required surface for parking; 3321.01, Dumpster area; 3363.24, Building lines in an M-manufacturing district; and 3363.41(a), Storage; for the property located at **5200 WINCHESTER PIKE (43110)**, to permit reduced development standards for manufacturing uses in the L-M, Limited Manufacturing District (Council Variance #CV23-010).

WHEREAS, by application #CV23-010, the owner of property at **5200 WINCHESTER PIKE (43110)**, requests a Council variance to permit reduced development standards for manufacturing uses in the L-M, Limited Manufacturing District; and

WHEREAS, Section 3311.28(b), More objectionable uses, requires a minimum 600 foot setback from residential districts for more objectionable uses, while the applicant proposes to maintain reduced setbacks as shown on the site plan from residential districts for a lumber yard use, which is considered to be a more objectionable use; and

WHEREAS, 3312.27(2), Parking setback line, requires a parking setback line of 25 feet from the street right-of-way, while the applicant proposes a parking setback of zero feet from Winchester Pike for the existing parking area in Subarea A; and

WHEREAS, Section 3312.43, Required surface for parking, requires the surface of any parking or loading space, parking lot, aisle, or driveway be designed to control storm water runoff and be improved with Portland cement, or other approved hard surface other than gravel or loose fill, while the applicant proposes to maintain

parking spaces, maneuvering and drive aisles with unimproved surfaces for Subarea A, noting that Subarea B will meet the requirements of this Section; and

WHEREAS, 3321.01(A), Dumpster area, requires that a dumpster be screened on all sides, while the applicant proposes no dumpster screening for Subarea A, and no screening for the lumber recycling dumpster for Subarea B; and

WHEREAS, 3363.24, Building lines in an M-manufacturing district, requires a building setback line of 60 feet, while the applicant to maintain a reduced building setback of 7.32 feet from Winchester Pike frontage for the existing building in Subarea A; and

WHEREAS, Section 3363.41(a), Storage, requires the open storage of materials to be located at a minimum of 100 feet from any residential or apartment residential district, while the applicant proposes to maintain an outside storage area within 25 feet of residential districts in Subarea A, as shown on the submitted site plan; and

WHEREAS, the Greater South East Area Commission recommends approval; and

WHEREAS, the City Departments recommend approval because the requested variances are similar to previously supported requests, and additional landscaping and screening, traffic access and improvements are included with the rezoning ordinance; and

WHEREAS, this ordinance requires separate submission for all applicable permits and a Certificate of Occupancy for the proposed use; and

WHEREAS, said variance will not adversely affect the surrounding property or surrounding neighborhood; and

WHEREAS, the granting of said variance will not impair an adequate supply of light and air to adjacent properties or unreasonably increase the congestion of public streets, or unreasonably diminish or impair established property values within the surrounding area, or otherwise impair the public health, safety, comfort, morals, or welfare of the inhabitants of the City of Columbus; and

WHEREAS, the granting of said variance will alleviate the difficulties encountered by the owners of the property located at **5200 WINCHESTER PIKE (43110)**, in using said property as desired; now, therefore:

BE IT ORDAINED BY THE COUNCIL OF THE CITY OF COLUMBUS:

SECTION 1. That a variance from the provisions of Sections 3311.28(b), More objectionable uses; 3312.27(2), Parking setback line; 3312.43, Required surface for parking; 3321.01, Dumpster area; 3363.24, Building lines in an M-manufacturing district; and 3363.41(a), Storage, of the Columbus City Codes, is hereby granted for the property located at **5200 WINCHESTER PIKE (43110)**, insofar as said sections prohibit the minimum separation of more objectionable uses from a residential district from 600 feet to what is reflected on the site plan; a reduced parking setback from 25 feet to zero feet in Subarea A for the existing parking area along Winchester Pike; unimproved surface for parking and maneuvering in Subarea A; no dumpster screening in Subarea A nor for the lumber recycling dumpster in Subarea B; reduced building setback lines from 60 feet to 7.32 feet in Subarea A; and reduced open storage setback along a residential district from 100 feet to 25 feet in Subarea A; said property being more particularly described as follows:

5200 WINCHESTER PIKE (43110), being 27.56± acres located on the north side of Winchester Pike, 1,650± feet east of Shannon Road, and being more particularly described as follows:

Parcel 1 (Subarea A):

Situated in the State of Ohio, County of Franklin, Township of Madison, lying in Section 10, Township 11, Range 21, and being a 15.759 acre tract conveyed to Strait Real Estate LLC 1 LTD by Instrument Number 199705230006729, records of the Recorder's Office, Franklin County, Ohio, and being more particularly described as follows:

Commencing at a Franklin County Monument #9946 at the southeast corner of said Section 10, southwest corner of Section 11, northwest corner of Section 14, and the northeast corner of Section 15, and the southwesterly corner of a 11.904 acre tract as conveyed to Arnold Estate Investments II LLC by Instrument Number 202110270195617;

Thence northerly along the east line of section 10, the west line of Section 11, and a 40.76 acre tract as conveyed to Ohio Lamb Farm LLC., in Instrument Number 201509170131006, **North 4°20'08" West, 722.51 feet**, to a point being the northeasterly corner of said 11.904 acre tract, and being the **Point of Beginning** for the herein described 15.900 acre tract;

Thence along the northerly line of said 11.904 acre tract, **North 84°45'24" West, 746.10 feet** to a Pipe Found, being a northeasterly corner of a 0.815 acre tract as conveyed to Stephen M. Forquer and Amy J. Forquer by Official Record 11460, Page F19;

Thence along the northerly line of said 0.815 acre tract, **North 84°45'38" West, 219.94 feet** to a point, being the northwesterly corner of a 1.469 acre tract as conveyed to Stephen M. Forquer and Amy J. Forquer by Official Record 11460, Page F19;

Thence along the westerly line of said 1.469 acre tract, **South 4°09'07" West, 403.06 feet** to a point in the southerly right-of-way of Winchester Pike;

Thence along the southerly right-of-way of said Winchester Pike, **North 47°29'41" West, 255.66 feet** to a point;

Thence **North 4°18'31" East, 744.60 feet** to an Iron Pipe Found, being the southwesterly corner of a 25.588 acre tract as conveyed to Trailway Resources LLC in Instrument Number 201909120118306;

Thence along the southerly line of said 25.588 acre tract the following two (2) courses:

South 84°55'52" East, 349.58 feet to an Iron Pipe Found;

Thence **North 87°05'14" East, 822.99 feet** to an Iron Pipe Found, being the northwesterly corner of said 40.76 acre tract;

Thence along the westerly line of said 40.76 acre tract, **South 4°20'08" West, 614.18 feet** to the **POINT OF BEGINNING**. Containing **15.900 acres**, more or less, and being subject to all easements, restrictions, and rights-of-way of record.

The bearings in the above description were based on the bearings of N 85°04'48" W, for the southerly line of Section 11 as shown of record in O.R. 20944 A15.

Subject to all valid and existing easements, restrictions and conditions of record.

Address: 5200 Winchester Pike, Columbus, OH 43110

PIN: 535-307599

Parcel 2 (Subarea B):

Situated in the State of Ohio, County of Franklin, Township of Madison, lying in Section 10, Township 11, Range 21, and being a 11.904 acre tract as conveyed to Arnold Estate Investments II LLC by Instrument Number 202110270195617, records of the Recorder's Office, Franklin County, Ohio, and being more particularly described as follows:

BEGINNING at a Franklin County Monument #9946 at the southeast corner of said Section 10, southwest corner of Section 11, northwest corner of Section 14, and the northeast corner of Section 15;

Thence along the southerly line of Section 10, **North 86°08'49" West, 437.03 feet** to an Iron Pipe Found, being a point in the northerly right-of-way line of Winchester Pike as conveyed to Franklin County Commissioners in Instrument Number 202112210230334;

Thence along the northerly right-of-way line of said Winchester Pike, **North 47°29'41" West, 392.72 feet** to a Pipe Found, being the southeasterly corner of a 0.815 acre tract as conveyed to Stephen M. Forquer and Amy J. Forquer by Official Record 11460, Page F19;

Thence **North 4°18'29" East, 495.31 feet** to a Pipe Found, being the northeasterly corner of said 0.815 acre tract, also being a point in the southerly line of a 15.77 acre tract as conveyed to Strait Real Estate LLC 1 LTD by Instrument Number 199705230006729;

Thence along the southerly line of said 15.77 acre tract, **South 84°45'24" East, 746.10 feet** to a point, being a point in the easterly line of said Section 10 and the westerly line of said Section 11;

Thence along the easterly line of said Section 10, **South 4°20'08" West, 722.51 feet** to the **POINT OF BEGINNING**. Containing **11.657 acres**, more or less, and being subject to all easements, restrictions, and rights-of-way of record.

The bearings in the above description were based on the bearings of N 85°04'48" W, for the southerly line of Section 11 as shown of record in O.R. 20944 A15.

Subject to all valid and existing easements, restrictions and conditions of record.

Address: 5200 Winchester Pike, Columbus, OH 43110

PIN: 535-307599

SECTION 2. That this ordinance is conditioned on and shall remain in effect only for so long as said property is used for those uses permitted in the L-M, Limited Manufacturing District as specified in Ordinance #2215-2023 (Z23-004).

SECTION 3. That this ordinance is further conditioned on the subject site being developed in general conformance with the plans titled "**SUBAREA A LAYOUT**," "**SUBAREA B LAYOUT**," and "**LANDSCAPE PLAN**," all dated July 13, 2023, signed by Thomas Hart, Attorney for the Applicant. The plans may be slightly adjusted to reflect engineering, topographical, or other site data developed at the time of the development and when engineering and architectural drawings are completed. Any slight adjustments to the plan shall be subject to review and approval by the Director of the Department of Building and Zoning Services, or a designee, upon submission of the appropriate data regarding the proposed adjustment.

SECTION 4. That this ordinance is further conditioned on the applicant obtaining all applicable permits and a

Certificate of Occupancy for the proposed use.

SECTION 5. That this ordinance shall take effect and be in force from and after the earliest period allowed by law.

Legislation Number: 2217-2023

Drafting Date: 7/14/2023

Version: 1

Current Status: Passed

Matter Type: Ordinance

Council Variance Application: CV23-021

APPLICANT: Phillina Poindexter; 6160 McNaughten Grove Lane; Columbus, OH 43227.

PROPOSED USE: Catering service.

MIDEAST AREA COMMISSION RECOMMENDATION: Approval.

CITY DEPARTMENTS' RECOMMENDATION: Approval. The site consists of one parcel developed with a nonconforming commercial building in the R-3, Residential District. The requested Council variance will permit the building to be used for non-assembly catering services (no event space permitted). A Council variance is required because a catering service is a commercial use and is not permitted in the R-3 district. A variance to reduce the minimum number of required parking spaces from 12 required to zero provided spaces is also included with this request. Staff are supportive as the proposal will reactivate an existing commercial structure with a use that is not considered to be incompatible with the area.

To grant a Variance from the provisions of Sections 3332.035, R-3 residential district; and 3312.49(C), Minimum numbers of parking spaces required, of the Columbus City Codes; for the property located at **803 BARNETT RD. (43227)**, to permit a non-assembly catering service business with a reduction in the minimum numbers of parking spaces required in the R-3, Residential District (Council Variance #CV23-021).

WHEREAS, by application #CV23-021, the owner of property at **803 BARNETT RD. (43227)**, is requesting a Council variance to permit a non-assembly catering service business with a reduction in the minimum numbers of parking spaces required in the R-3, Residential District; and

WHEREAS, Section 3332.035, R-3 residential district, prohibits commercial uses, while the applicant proposes to use the existing building as a catering service business with no assemble space permitted; and

WHEREAS, Section 3312.49(C), Minimum numbers of parking spaces required, requires one parking space per 450 square feet for non-assembly catering uses for a total of 12 required parking spaces, while the applicant proposes to maintain zero parking spaces; and

WHEREAS, the Mideast Area Commission recommends approval; and

WHEREAS, the City Departments recommend approval because this request will reactivate an existing commercial structure with a use that is not considered to be incompatible with the area; and

WHEREAS, said ordinance requires separate submission for all applicable permits and Certificate of Occupancy for the proposed use; and

WHEREAS, said variance will not adversely affect the surrounding property or surrounding neighborhood; and

WHEREAS, the granting of said variance will not impair an adequate supply of light and air to the adjacent property, unreasonably increase the congestion of public streets, increase the danger of fires, endanger the public safety, unreasonably diminish or impair established property values within the surrounding area, or in any other respect impair the public health, safety, comfort, morals or welfare of the inhabitants of the City of Columbus; and

WHEREAS, the granting of said variance will alleviate the difficulties encountered by the owner of the property located at **803 BARNETT RD. (43227)**, in using said property as desired; now, therefore:

BE IT ORDAINED BY THE COUNCIL OF THE CITY OF COLUMBUS:

SECTION 1. That a variance from the provisions of Sections 3332.035, R-3 residential district; and 3312.49(C), Minimum numbers of parking spaces required, of the Columbus City Codes; is hereby granted for the property located at **803 BARNETT RD. (43227)**, insofar as said sections prohibit a non-assembly catering service business in the R-3, Residential District; with a parking space reduction from 12 required parking spaces to zero provided spaces; said property being more particularly described as follows:

803 BARNETT AVE. (43207), being 0.10± acres located on the west side of Barnett Road, 155± feet south of East Main Street, and being more particularly described as follows:

Situated in the State of Ohio, County of Franklin, and in the City of Columbus:

Being Lot Number Three Hundred Ninety (390) of MAIN STREET TERRACE SECOND ADDITION, as the same is numbered and delineated upon the recorded plat thereof, of record in Plat Book 7, Page 261, Recorder's Office, Franklin County, Ohio.

Property Address: 803 Barnett Rd, Columbus, OH 43227

Parcel No.: 010-089074-00

SECTION 2. That this ordinance is conditioned on and shall remain in effect only for so long as said property is used for a non-assembly catering service, or those uses permitted in the R-3, Residential District.

SECTION 3. That this ordinance is further conditioned on the applicant vacating the parking spaces located along the Barnett Road frontage that encroach or maneuver within the right-of-way, and installing a no parking sign at the front of the property.

SECTION 4. That this ordinance is further conditioned upon the applicant obtaining all applicable permits and a Certificate of Occupancy for the proposed use.

SECTION 5. That this ordinance shall take effect and be in force from and after the earliest period allowed by law.

Legislation Number: 2218-2023

Drafting Date: 7/14/2023

Current Status: Passed

Council Variance Application: CV23-039

APPLICANT: Michael Zaller; 170 Franklin Avenue; Worthington, OH 43085.

PROPOSED USE: Commercial office.

NEAR EAST AREA COMMISSION RECOMMENDATION: Approval.

CITY DEPARTMENTS' RECOMMENDATION: Approval. The site consists of one parcel developed with a vacant nonconforming commercial building in the ARLD, Apartment Residential District. The requested Council variance will permit the building to be used as a commercial office which is not permitted in the ARLD district. The site is within the planning boundaries of the *Near East Area Plan* (2005), which does not include a specific land use recommendation at this location. Staff are supportive as the proposal will conform the existing commercial building, which is not introducing an incompatible use to the area.

To grant a Variance from the provisions of Section 3333.02, AR-12, ARLD and AR-1 apartment residential district use, of the Columbus City Codes; for the property located at **1291 OAK ST. (43205)**, to permit commercial office uses in the ARLD, Apartment Residential District (Council Variance #CV23-039).

WHEREAS, by application #CV23-039, the owner of property at **1291 OAK ST. (43205)**, is requesting a Council variance to permit commercial office uses in the ARLD, Apartment Residential District; and

WHEREAS, Section 3333.02, AR-12, ARLD and AR-1 apartment residential district use, does not permit commercial uses, while the applicant proposes to utilize the existing nonconforming structure for commercial office uses; and

WHEREAS, the Near East Area Commission recommends approval; and

WHEREAS, the City Departments recommend approval because this request will conform the existing commercial building and is not considered to be the introduction of an incompatible use to the area; and

WHEREAS, said ordinance requires separate submission for all applicable permits and Certificate of Occupancy for the proposed use; and

WHEREAS, said variance will not adversely affect the surrounding property or surrounding neighborhood; and

WHEREAS, the granting of said variance will not impair an adequate supply of light and air to the adjacent property, unreasonably increase the congestion of public streets, increase the danger of fires, endanger the public safety, unreasonably diminish or impair established property values within the surrounding area, or in any other respect impair the public health, safety, comfort, morals or welfare of the inhabitants of the City of Columbus; and

WHEREAS, the granting of said variance will alleviate the difficulties encountered by the owner of the property located at **1291 OAK ST. (43205)**, in using said property as desired; now, therefore:

BE IT ORDAINED BY THE COUNCIL OF THE CITY OF COLUMBUS:

SECTION 1. That a variance from the provisions of Section 3333.02, AR-12, ARLD and AR-1 apartment residential district use, of the Columbus City Codes; is hereby granted for the property located at **1291 OAK ST. (43205)**, insofar as said section prohibits general and medical office uses; said property being more particularly described as follows:

1291 OAK ST. (43205), being 0.10± acres located on the south side of Oak Street, 150± feet west of , and being more particularly described as follows:

Situated in the State of Ohio, County of Franklin, and City of Columbus and bounded and described as follows:

Being Lot Number Six (6) of McGRAW AND BLOSE SUBDIVISION, as the same is numbered and delineated upon the recorded plat thereof, of record in Plat Book 4, Page 407, Recorder's Office, Franklin County, Ohio.

Address: 1291 Oak Street Columbus, Ohio 43205

Parcel No.: 010-016979

SECTION 2. That this ordinance is conditioned on and shall remain in effect only for so long as said property is used for general or medical office uses, or those uses permitted in the ARLD, Apartment Residential District.

SECTION 3. That this ordinance is further conditioned upon the applicant obtaining all applicable permits and a Certificate of Occupancy for the proposed use.

SECTION 4. That this ordinance shall take effect and be in force from and after the earliest period allowed by law.

Legislation Number: 2219-2023

Drafting Date: 7/14/2023

Current Status: Passed

Version: 1

Matter Type: Ordinance

To authorize the City Auditor to modify and extend the contract with OnActuate Consulting and to modify the contract for Microsoft licensing and services through Dell Marketing LP; to waive the competitive bidding provisions of Columbus City Code to extend such contracts; to authorize the expenditure of \$450,000.00 from the Auditor Bond fund; and to declare an emergency. (\$450,000.00)

WHEREAS, professional technical and consulting services are needed by City Auditor's Office to extend D365 and Point of Sale; and

WHEREAS, development work is necessary to expand the use of Azure, Power platform, and enhance analytics and data mining of D365 data; and

WHEREAS, it is in the best interest of the City to waive the competitive bidding requirements of Chapter 329 of the City Code due to the need to quickly secure the services to avoid delays and interruptions to vital financial operations; and

WHEREAS, it is necessary to authorize the expenditure of \$450,000 from the Auditor's Bond Fund; and

WHEREAS, Microsoft, Dell, and OnActuate are sole source providers;

WHEREAS, an emergency exists in the usual daily operation of the City Auditor's Office in that it is

immediately necessary to authorize the City Auditor to modify existing contracts with OnActuate, Microsoft, and Dell for the services described in order to avoid any potential disruption in service for the City's financial system Dynamics D365. Delay could put financial transactions at risk and cause failures in functionality such as vendor payments, PO confirmations, and recording of revenue in a timely manner;

NOW, THEREFORE,

BE IT ORDAINED BY THE COUNCIL OF THE CITY OF COLUMBUS:

SECTION 1: That the City Auditor be and is hereby authorized to modify its professional services contract with OnActuate Consulting and to modify the contract for Microsoft licensing and services through Dell Marketing LP for professional services, licensing, and other services to upgrade City code and platform assets related to D365 and financial systems supported in Azure.

SECTION 2: That this Council deems it in the best interests of the City to waive the competitive bidding provisions of the Columbus City Code to extend these contracts.

SECTION 3: That the expenditure of \$450,000.00, or so much thereof as may be needed is hereby authorized from fund 7783 (Auditor Bond Fund) Dept./Div. No. 22-01 , Object Class 06, Main account 66530, Project P783002-100002 per the account codes in the attachment to this ordinance.

SECTION 4: That the monies in the foregoing Section 4 shall be paid upon order of the City Auditor, and that no order shall be drawn or monies paid except by voucher, the form of which shall be approved by the City Auditor.

SECTION 5. Funds are hereby deemed appropriated and expenditures and transfers authorized to carry out the purposes of this ordinance and the City Auditor shall establish such accounting codes as necessary.

SECTION 6. That the City Auditor is authorized to make any accounting changes to revise the funding source for all contracts or contract modifications associated with this ordinance.

SECTION 7: That the City Auditor is hereby authorized to transfer the unencumbered balance in a project account to the unallocated balance account within the same fund when said project has been completed and the monies are no longer needed.

SECTION 8: That for the reasons stated in the preamble hereto, which is hereby made a part hereof, this ordinance is hereby declared to be an emergency measure and shall take effect and be in force from and after its passage and approval by the Mayor, or ten days after passage if the Mayor neither approves nor vetoes the same.

Legislation Number: 2221-2023

Drafting Date: 7/14/2023

Version: 1

Current Status: Passed

Matter Type: Ordinance

Council Variance Application: CV23-049

APPLICANT: Central Ohio Opportunity Fund, LLC; c/o Sean Mentel, Atty.; 250 East Town Street, Suite 200; Columbus, OH 43215.

PROPOSED USE: Multi-unit residential development.

NEAR EAST AREA COMMISSION RECOMMENDATION: Approval.

CITY DEPARTMENTS' RECOMMENDATION: Approval. The site is undeveloped and zoned in the M, Manufacturing District. The applicant is requesting a Council variance to permit the development of a

multi-unit residential development. The site is within the boundaries of the *Near East Area Plan (2005)*, which recommends “Office/Light Industrial/Mixed Uses” at this location. This proposed development will be subject to a competitive funding process by the Ohio Housing Finance Agency (OHFA) or other applicable agency, which requires certain land attributes including compliant zoning. The site is adjacent to land subject to Ordinance #0117-2020 (CV19-118; 1750 Maryland Avenue), which was approved to permit the development of a multi-unit residential development in order to secure funding from the U.S. Department of Housing and Urban Development. Both sites are pending rezoning to the L-ARLD, Limited Apartment Residential District under Rezoning Application #Z19-095 for one cohesive development. The Planning Division does not object to this limited Council variance request, recognizing that this ordinance includes a condition that a Certificate of Zoning Clearance will not be issued until Rezoning Application #Z19-095 is completed. Comments related to site design, building design, and other matters for the project will be provided at the time of rezoning and review of concurrent Council Variance #CV20-115, but the applicant is strongly encouraged to consult with Planning Division Staff before Z19-095 is reconsidered by the Development Commission.

To grant a Variance from the provisions of Section 3363.01, Manufacturing districts, of the Columbus City Codes; for the property located at **1728 MARYLAND AVE. (43203)**, to permit a multi-unit residential development in the M, Manufacturing District (Council Variance #CV23-049).

WHEREAS, by application #CV23-049, the owner of property at **1728 MARYLAND AVE. (43203)**, is requesting a Council variance to permit a multi-unit residential development in the M, Manufacturing District; and

WHEREAS, Section 3363.01, Manufacturing districts, only permits a residence for on-site security persons or transient-type housing such as halfway houses, residential treatment centers, or temporary shelters, while the applicant proposes a multi-unit residential development; and

WHEREAS, the Near East Area Commission recommends approval; and

WHEREAS, City Departments recommend approval because the requested variance will help facilitate affordable housing funding requirements. However, a Certificate of Zoning Clearance will not be issued until follow-up Rezoning Application #Z19-095 is completed; and

WHEREAS, said variance will not adversely affect the surrounding property or surrounding neighborhood; and

WHEREAS, the granting of said variance will not impair an adequate supply of light and air to adjacent properties or unreasonably increase the congestion of public streets, or unreasonably diminish or impair established property values within the surrounding area, or otherwise impair the public health, safety, comfort, morals, or welfare of the inhabitants of the City of Columbus; and

WHEREAS, the granting of said variance will alleviate the difficulties encountered by the owners of the property located at **1728 MARYLAND AVE. (43203)**, in using said property as desired; now, therefore:

BE IT ORDAINED BY THE COUNCIL OF THE CITY OF COLUMBUS:

SECTION 1. That a variance from the provisions of Section 3363.01, Manufacturing districts, of the Columbus City Codes, is hereby granted for the property located at **1728 MARYLAND AVE. (43203)**, insofar as said sections prohibit a multi-unit residential development in the M, Manufacturing District; said property being more particularly described as follows:

1728 MARYLAND AVE. (43203), being 0.90± acres located on the north side of Maryland Avenue, 335± feet west of Woodland Avenue and being more particularly described as follows:

DESCRIPTION OF 0.896 ACRE TRACT

Situated in the State of Ohio, County of Franklin, City of Columbus, being part of Section 2, Township 5, Range 22, Refugee Lands, being part of Lots 29, 30, 31, 32, 33, 34, and 35 and being all of Lots 36 and 37 of Huling, Sherwood & Wirth's Norfolk Addition of record in Plat Book 5, Page 90 and amended in Plat Book 7, Page 48, being part of Superior Street, a 15 foot wide alley, and a 20 foot wide alley of said Huling, Sherwood & Wirth's Norfolk Addition vacated by the City of Columbus in Ordinance Number 714-41, being part of Superior Street and Roland Court of said Huling, Sherwood & Wirth's Norfolk Addition, and being all of a 0.984 acre tract of land described in deed to Central Ohio Opportunity Fund, LLC of record in Instrument Number 202207280109717, all references being of record in the Recorder's Office, Franklin County, Ohio, and being more particularly described as follows:

BEGINNING at an iron pin set at the southwest corner of Lot 37 and the southeast corner of Lot 38 of said Huling, Sherwood & Wirth's Norfolk Addition, being on the north right-of-way line of I. R. Witcher Lane (15 feet wide) formerly known as a 15 foot wide alley of said Huling, Sherwood & Wirth's Norfolk Addition (name changed by the City of Columbus in Ordinance Number 0295-01), and being at a southwest corner of said 0.984 acre tract;

Thence North 03°58'51" East, a distance of 170.13 feet with a west line of said 0.984 acre tract, with the common line of said Lots 37 and 38, and then crossing said Superior Street, to an iron pin set at the northwest corner of said 0.984 acre tract, being on the north right-of-way line of said Superior Street, being on the south line of Lot 69 of said Huling, Sherwood & Wirth's Norfolk Addition, and being on a south line of a 4.933 acre tract of land described in deed to Central Ohio Opportunity Fund, LLC of record in Instrument Number 201911130151099;

Thence South 86°00'17" East, a distance of 60.23 feet with the north line of said 0.984 acre tract, with the north right-of-way line of said Superior Street, with the south line of said Lot 69, and with a south line of said 4.933 acre tract, to a 5/8" rebar found with an Advanced PS 7661 cap;

Thence South 50°21'24" East, a distance of 265.95 feet with the northeast line of said 0.984 acre tract, with the southwest line of said 4.933 acre tract, crossing said Superior Street, then crossing said Lots 35, 34, 33, and 32, to a 5/8" rebar found with an Advanced PS 7661 cap;

Thence South 34°39'53" East, a distance of 160.08 feet with the northeast line of said 0.984 acre tract, with the southwest line of said 4.933 acre tract, crossing said Lot 32, crossing said vacated 15 foot alley, crossing said Lots 30 and 31, then crossing said vacated 20 foot alley, to a 5/8" rebar found with an Advanced PS 7661 cap;

Thence South 03°59'43" West, a distance of 25.04 feet with the east line of said 0.984 acre tract, with a west line of said 4.933 acre tract, crossing said vacated 20 foot alley then crossing said Lot 31, to a 3/4" iron pipe found at the southeast corner of said 0.984 acre tract, being at a southwest corner of said 4.933 acre tract, being on the south line of said Lot 31, and being on the north right-of-way line of Maryland Avenue (60 feet wide) formerly known as Atcheson Street of said Huling, Sherwood & Wirth's Norfolk Addition (name changed by the City of Columbus in Ordinance Number 25534);

Thence North 86°01'09" West, a distance of 100.27 feet with a south line of said 0.984 acre tract, with the

south line of said Lots 31, 30 and 29, and with the north right-of-way line of said Maryland Avenue, to a 3/4” iron pipe found at a southwest corner of said 0.984 acre tract and being on the east right-of-way line of a 16 foot alley dedicated by the City of Columbus in Ordinance Number 715-41;

Thence North 03°58'51" East, a distance of 135.00 feet with a west line of said 0.984 acre tract and with the east right-of-way line of said 16 foot alley, to an iron pin set on a south line of said 0.984 acre tract, being on the south line of said Lot 32, and being on the north right-of-way line of said I. R. Witcher Lane;

Thence North 86°01'09" West, a distance of 276.00 feet with a south line of said 0.984 acre tract, with the south line of said Lot 32, crossing said Roland Court, with the south line of Lots 36 and 37, and with the north right-of-way line of said I. R. Witcher Lane, to the POINT OF BEGINNING containing 0.896 acres out of said 0.984 acre tract and Parcel Number 010-098968, and being subject to all easements and documents of record.

SECTION 2. That this ordinance is further conditioned on no Certificate of Zoning Clearance being granted until Rezoning Application #Z19-095 is completed.

SECTION 3. That this ordinance shall take effect and be in force from and after the earliest period allowed by law.

Legislation Number: 2224-2023

Drafting Date: 7/14/2023

Current Status: Passed

Version: 1

Matter Type: Ordinance

To authorize the City Auditor to enter into contract with Johnson Mirmiran & Thompson, Inc. dba JMT Technology Group; to authorize the expenditure of \$470,000.00 from the Auditor Bond Fund. (\$470,000.00); and to declare an emergency.

WHEREAS, it is necessary to authorize the City Auditor to enter into contract with Johnson Mirmiran & Thompson, Inc. dba JMT Technology Group for Professional IT Consulting and Programming Services for financial systems archival project; and

WHEREAS, it is necessary to authorize the expenditure of \$470,000.00 from the Auditor Bond Fund 7783; and

WHEREAS, an emergency exists to maintain access to and retain required records in the City Auditor’s Office and to mitigate the risk of failure of an outdated system in fulfilling public records requests, maintaining compliance with record retention requirements and conducting historical research making it immediately necessary to authorize the City Auditor to execute the contract without delay, all for the immediate preservation of the public health, peace, property, safety and welfare; and

NOW, THEREFORE,

BE IT ORDAINED BY THE COUNCIL OF THE CITY OF COLUMBUS:

SECTION 1: That the City Auditor be and is hereby authorized to enter into contract with Johnson Mirmiran & Thompson, Inc. dba JMT Technology Group for Professional IT Consulting and Programming Services for financial systems archival project;

SECTION 2: That the expenditure of \$470,000.00, or so much thereof as may be needed is hereby authorized from fund 7783 (Auditor Bond Fund) Dept./Div. No. 22-01 , Object Class 06, Main account 66530, Project

P783002-100002 per the account codes in the attachment to this ordinance.

SECTION 3: That the monies in the foregoing Section 2 shall be paid upon order of the City Auditor, and that no order shall be drawn or monies paid except by voucher, the form of which shall be approved by the City Auditor.

SECTION 4. Funds are hereby deemed appropriated and expenditures and transfers authorized to carry out the purposes of this ordinance and the City Auditor shall establish such accounting codes as necessary.

SECTION 5. That the City Auditor is authorized to make any accounting changes to revise the funding source for all contracts or contract modifications associated with this ordinance.

SECTION 6: That the City Auditor is hereby authorized to transfer the unencumbered balance in a project account to the unallocated balance account within the same fund when said project has been completed and the monies are no longer needed.

SECTION 7: That for the reasons stated in the preamble hereto, which is hereby made a part hereof, this ordinance is hereby declared to be an emergency measure and shall take effect and be in force from and after its passage and approval by the Mayor, or ten days after passage if the Mayor neither approves nor vetoes the same.

Legislation Number: 2227-2023

Drafting Date: 7/14/2023

Version: 1

Current Status: Passed

Matter Type: Ordinance

Background: This ordinance amends ordinance 1521-2023. The Charles Madison Nabrit Memorial Garden was authorized by Ord 1521-2023 to receive grant funds. However that entity is not the legal name of the organization, it is a registered DBA of the legal entity Telos Training, Inc. Therefore an amendment is necessary to change the name of the organization authorized to receive funding from The Charles Madison Nabrit Memorial Garden to Telos Training, Inc

A further amendment is needed to authorize the expenditure of funds by grantees listed in 1521-2023 for the purchase of reasonable food & non-alcoholic beverages for summer youth program participants.

Principal Parties:

Telos Training, Inc.
DBA The Charles Madison Nabrit Memorial Garden
4083 Easton Way
Columbus, OH 43219
(614) 835-6784
Contract Compliance Number: CC-014886
Contract Compliance Expiration Date: July 7, 2025

Emergency Justification: Emergency action is requested in order to execute the grant agreement with Telos Training authorized by 1521-2023. The funding for the grant is intended for summer programming which is already in progress and the organization is depending on the funds for incurred expenses.

Fiscal Impact: The expenditure of \$33,245.00 was authorized by ORD 1521-2023 and is encumbered on ACPO009155.

To amend ordinance 1521-2023 to authorize the Director of the Recreation and Parks Department to enter into a City funded grant agreement for youth programming with Telos Training, Inc DBA The Charles Madison Nabrit Memorial Garden instead of The Charles Madison Nabrit Memorial Garden; to authorize the purchase of food by grantees authorized under 1521-2023; and to declare an emergency. (\$0.00)

WHEREAS, it is necessary to amend ordinance 1521-2023 authorizing the Director of the Recreation and Parks Department to enter into a grant agreement for youth programming with Telos Training, Inc DBA The Charles Madison Nabrit Memorial Garden instead of The Charles Madison Nabrit Memorial Garden; and

WHEREAS, it is necessary to authorize the expenditure of funds by grantees listed in 1521-2023 for the purchase of reasonable food & non-alcoholic beverages for summer youth program participants to serve a proper public purpose by nourishing summer program participants with nutritious snacks and meals while they are attending camps and programs; and

WHEREAS, an emergency exists in the usual daily operations of the Recreation and Parks Department in that it is immediately necessary to authorize the Director of Recreation and Parks to execute the grant agreement with Telos Training, Inc, DBA The Charles Madison Nabrit Memorial Garden because the summer programming funded by the grant is already in progress and the organization is depending on the funds for incurred expenses, **NOW, THEREFORE**

BE IT ORDAINED BY THE COUNCIL OF THE CITY OF COLUMBUS:

SECTION 1. That Ordinance 1521-2023 is hereby amended to authorize the Director of the Recreation and Parks Department to enter into a grant agreement for youth programming with Telos Training, Inc DBA The Charles Madison Nabrit Memorial Garden instead of The Charles Madison Nabrit Memorial Garden.

SECTION 2. That the expenditure of funds by grantees listed in 1521-2023 for the purchase of reasonable food & non-alcoholic beverages for summer youth program participants to serve a proper public purpose by nourishing summer program participants with nutritious snacks and meals while they are attending camps and programs is hereby authorized.

SECTION 3. That all other provisions within ordinance 1521-2023 shall remain the same.

SECTION 4. That for the reasons stated in the preamble hereto, which is hereby made a part hereof, this ordinance is hereby declared to be an emergency measure and shall take effect and be in force from and after its passage and approval by the Mayor, or ten days after passage if the Mayor neither approves nor vetoes the same.

Legislation Number: 2228-2023

Drafting Date: 7/14/2023

Current Status: Passed

Version: 1

Matter Type: Ordinance

BACKGROUND: Columbus City Council (“**COUNCIL**”), by Ordinance No. 1902-2015, passed July 27, 2015, authorized the City of Columbus (“**CITY**”) to enter into an Community Reinvestment Area Agreement (the “**AGREEMENT**”) with N.P. Limited Partnership (“**ENTERPRISE**”) for a tax abatement of one-hundred percent (100%) for a period of ten (10) years in consideration of a proposed \$24 million investment in real property improvements. Additionally, the **ENTERPRISE** committed to creating

approximately 708 full-time jobs with an associated annual payroll of approximately \$45,489,000.00 upon full build-out and occupancy, and committed to relocate approximately 177 employees currently employed within the CITY related to the construction of a series of buildings containing speculative office space (either primarily or as one component of mixed-use buildings) totaling approximately 177,000 square feet along with two associated 600 space parking structures (the "PROJECT") on one newly expanded parcel, 318-431-01-017-000 (recently combined from the two adjacent parcels 318-431-01-017-000 and 318-431-01-013-003), zip code 43240 in Delaware County within the City of Columbus and within the Old State Road Community Reinvestment Area (the "PROJECT SITE"). The **AGREEMENT** was made and entered into effective October 23, 2015 (CRA #049-00960-06/15-001) with the abatement to commence no later than tax year 2026 nor extend beyond tax year 2035.

Pursuant to Ordinance No. 1256-2016, passed May 16, 2016, the First Amendment for Assignment and Assumption to the **AGREEMENT** (the "**FIRST AMENDMENT**") was made and entered into effective on June 30, 2016 to amend the **AGREEMENT** to assign all of the benefits and obligations from N.P. Limited Partnership to The Pointe at Polaris Phase I, LLC ("Pointe I"), and to assign certain benefits and obligations from Pointe I to the Columbus-Franklin County Finance Authority ("Finance Authority"). Pointe I and the Finance Authority submitted an application for abatement related to the first phase of the PROJECT ("PHASE I") to the CITY on July 16, 2018, and the City certified to the Delaware County Auditor (the "AUDITOR") that the project described in the application met the necessary requirements for exemption and granted a 10-year, 100% exemption to the applicable improvements on Parcel Number 318-431-01-017-006, to commence January 1, 2018 with the term of the abatement to run through 2027.

Pursuant to Ordinance No. 1519-2019, passed June 10, 2019, the legislation authorized the Director of the Department of Development to amend the **AGREEMENT** for the second time ("**SECOND AMENDMENT**") to add The Pointe at Polaris Phase II, LLC as party to the **AGREEMENT**, to clarify the obligations and commitments of all parties to the **AGREEMENT** and to allow for exclusion for the CRA exemption that portion of the **PROJECT SITE** to be occupied by office tenants on the Phase II parcel that elect not to receive any of the benefits that may be associated with the forgone tax associated with a tax abatement related to the Phase II real property improvements. The **SECOND AMENDMENT** was made and entered into effective July 10, 2019.

Subsequently, the ongoing impact of the COVID-19 pandemic, and the many employees working from home, continues to impair the office real estate market as worker occupancy rates remain significantly lower than pre-pandemic levels. Additionally, pursuant to the Tax Incentive Review Council ("TIRC") meeting on August 19, 2022, it was recommended that the **CITY** work with the **ENTERPRISE** to amend the **AGREEMENT** to right size the job creation based on the revised reduced amount of square footage due to the **SECOND AMENDMENT** and the actual jobs present in the Phase I and II upon current occupancy based on the **ENTERPRISE** annual report from 2021 which demonstrated 177 retained jobs and 142 new jobs. On October 10, 2022, Columbus City Council passed Resolution 0184X-2022 accepting the recommendations of the 2022 TIRC meeting. The **ENTERPRISE's** largest tenant, which occupies approximately 61,000 square feet of office space at the **PROJECT SITE** determined it did not want to benefit from the **CRA** exemption; therefore, the significant amount of jobs created by the tenant are not being considered for purposes of the total number of jobs created or retained under this **AGREEMENT**. The retained and new jobs include those from Dwight Capital, Cathcart, Fusion, Ohio Real Title, and Anthem. This project, now stabilized, will be adjusted based on the current occupants within the building and reviewed annually by the TIRC consistent with their recommendation.

The **ENTERPRISE** shall continue to share income tax revenues with the applicable school district under a section of the **AGREEMENT** that requires payments from the **ENTERPRISE** in the event income taxes do

not reach agreed upon levels. Accordingly, in the interest of providing clarity, the **CITY** and **ENTERPRISE** determine the current **CARRYFORWARD AMOUNT** (as defined in the **AGREEMENT**).

This legislation is to authorize the Director of the Department of Development to amend the **AGREEMENT** for the third time to right size the job creation based on the revised reduced amount of square footage due to the **SECOND AMENDMENT** and the actual jobs present in the Phase I and II upon occupancy, which follows the recommendations of the TIRC, and to authorize the Director of the Department of Development to stipulate to the current **CARRYFORWARD AMOUNT**.

This legislation is being presented as 30-day legislation.

FISCAL IMPACT:

No funding is required for this legislation.

This legislation is to authorize the Director of the Department of Development to amend the City of Columbus Community Reinvestment Area Agreement for the third time to right size the job creation commitment based on the revised reduced amount of square footage of the project per the Tax Incentive Review Council ("TIRC") recommendations, and to determine the current Carryforward Amount.

WHEREAS, the City of Columbus ("CITY") entered into a Community Reinvestment Area Agreement (the "**AGREEMENT**") with N.P. Limited Partnership, approved by Columbus City Council ("COUNCIL") on July 17, 2015 by Ordinance No. 1902-2015 with this **AGREEMENT** made and entered into effective October 23, 2015; and

WHEREAS, the **AGREEMENT** granted a 100%/10-Year abatement on real property improvements; and

WHEREAS, the incentive was granted in consideration of a \$24 million investment in real property improvements, the relocation of 177 employees currently employed within the CITY and the creation of 708 full-time jobs with an annual payroll of approximately \$45,489,000 upon full build-out related to the construction of a series of buildings containing speculative office space (either primarily or as one component of mixed-use buildings) totaling approximately 177,000 square feet along with two associated 600 space parking structures as of the original effective date of the **AGREEMENT** on one newly expanded parcel, 318-431-01-017-000 (combined from the two adjacent parcels 318-431-01-017-000 and 318-431-01-013-003), zip code 43240 in Delaware County within the City of Columbus and within the Old State Road Community Reinvestment Area with the abatement to commence no later than tax year 2026 nor extend beyond tax year 2035; and

WHEREAS, pursuant to Ordinance No. 1256-2016, passed May 16, 2016, **COUNCIL** authorized the First Amendment for Assignment and Assumption to the **AGREEMENT** (the "**FIRST AMENDMENT**") which was entered into on June 30, 2016 to amend the **AGREEMENT** to assign all of the benefits and obligations from N.P. Limited Partnership to The Pointe at Polaris Phase I, LLC ("Pointe I"), and to assign certain benefits and obligations from Pointe I to the Columbus-Franklin County Finance Authority ("Finance Authority"); and

WHEREAS, Pointe I and the Finance Authority submitted an application for abatement related to the first phase of the PROJECT ("**PHASE I**") to the CITY on July 16, 2018, and the City certified to the Delaware County Auditor (the "**AUDITOR**") that the project described in the application met the necessary requirements

for exemption and granted a 10-year, 100% exemption to the applicable improvements on Parcel Number 3I 8-431-01-017-006, to commence January I, 2018 with the term of the abatement to run through 2027; and

WHEREAS, in a letter dated April 29, 2019 and subsequent discussion and email communication with representatives of **ENTERPRISE**, the **CITY** had been advised that the **PROJECT SITE** consists of three parcels, two parcels related to PHASE I and a third parcel related to the second phase of the **PROJECT** ("PHASE II"); and

WHEREAS, the **ENTERPRISE** advised the **CITY** (i) of the final scope of PHASE I and the proposed scope of PHASE II; (ii) that a new entity, The Pointe at Polaris Phase II, LLC ("Pointe II"), will be the entity that will own the PHASE II parcel and so needs to be added as **ENTERPRISE** and party to the **AGREEMENT**; (iii) that the obligations and commitments of Pointe I, Pointe II and the Finance Authority should be clarified; and (iv) that one or more office tenants that are expected to occupy space upon completion of the improvements related to PHASE II may not desire to receive any of the benefits that may be associated with the forgone tax associated with a tax abatement related to the PHASE II real property improvements; and

WHEREAS, pursuant to Ordinance No. 1519-2019, passed June 10, 2019, the legislation authorized the Director of the Department of Development to amend the **AGREEMENT** for the second time ("**SECOND AMENDMENT**") to add The Pointe at Polaris Phase II, LLC as party to the **AGREEMENT**, to clarify the obligations and commitments of all parties to the **AGREEMENT** and to allow for exclusion for the CRA exemption that portion of the **PROJECT SITE** to be occupied by office tenants on the Phase II parcel that elect not to receive any of the benefits that may be associated with the forgone tax associated with a tax abatement related to the Phase II real property improvements. The **SECOND AMENDMENT** was made and entered into effective July 19, 2019; and

WHEREAS, subsequently, the ongoing effect of the COVID-19 pandemic, and the many employees working from home, continues to impair the office real estate market, as worker occupancy rates remain significantly lower than pre-pandemic levels, and pursuant to the Tax Incentive Review Council ("**TIRC**") recommendations on August 19, 2022, and approved by Columbus City Council on October 10, 2022, by Resolution 0184X-2022, accepting the recommendations, it was recommended that the **CITY** work with the **ENTERPRISE** to amend the **AGREEMENT** to right size the job creation based on the revised reduced amount of square footage due to the **SECOND AMENDMENT** and the actual jobs present in the Phase I and II upon occupancy - 177 retained jobs and 142 new jobs. The **ENTERPRISE's** largest tenant, which occupies approximately 61,000 square feet of office space at the **PROJECT SITE** determined it did not want to benefit from the **CRA** exemption; therefore, the significant amount of jobs created by the tenant are not being considered for purposes of the total number of jobs created or retained under this **AGREEMENT**. The buildings currently have 177 retained jobs and 142 new jobs from Dwight Capital, Cathcart, Fusion, Ohio Real Title, and Anthem. This project, now stabilized, will be adjusted based on the current occupants within the building as recommended by the **TIRC** and reviewed annually; and

WHEREAS, the **ENTERPRISE** shall continue to share income tax revenues with the applicable school district under a section of the **AGREEMENT** that requires payments from the **ENTERPRISE** in the event income taxes do not reach agreed upon levels. Accordingly, in the interest of providing clarity, the **CITY** and **ENTERPRISE** determine the current **CARRYFORWARD AMOUNT** (as defined in the **AGREEMENT**); and

WHEREAS, a third amendment to the **AGREEMENT**, which may be in the form of an amended and restated **AGREEMENT**, is now needed to right size the job creation commitment based on the revised reduced amount of square footage due to the **SECOND AMENDMENT** and the actual jobs present in the Phase I and II upon

occupancy, which follows the recommendations of the TIRC, and to stipulate to the current **CARRYFORWARD AMOUNT**; and **NOW, THEREFORE,**

BE IT ORDAINED BY THE COUNCIL OF COLUMBUS

SECTION 1. That the Director of the Department is hereby authorized to amend the City of Columbus Community Reinvestment Area Agreement with The Pointe at Polaris Phase I, LLC, The Pointe at Polaris Phase II, LLC and the Columbus-Franklin County Finance Authority (the **AGREEMENT**) to amend Section 4 (Employee Positions and Salaries) of the **AGREEMENT**, to state that the **ENTERPRISE** shall create or cause to be created 142 new full-time permanent positions and retain 177 full-time employees and to stipulate to the current **CARRYFORWARD AMOUNT** (as defined in the **AGREEMENT**).

SECTION 2. That this **THIRD AMENDMENT** to the City of Columbus Community Reinvestment Area Agreement, which may be in the form of an amended and restated **AGREEMENT**, be signed by The Pointe at Polaris Phase I, LLC, The Pointe at Polaris Phase II, LLC and the Columbus-Franklin County Finance Authority within ninety (90) days of passage of this ordinance, or this ordinance and the incentive authorized herein shall be null and void.

SECTION 3. That this Ordinance shall take effect and be in force from and after the earliest period allowed by law.

Legislation Number: 2230-2023

Drafting Date: 7/14/2023

Current Status: Passed

Version: 1

Matter Type: Ordinance

BACKGROUND: This ordinance is being submitted to set forth the municipal services and zoning conditions the city of Columbus will provide upon annexation of a territory located in Prairie Township. This ordinance is required by the Ohio Revised Code (ORC) as enacted by the General Assembly of the State of Ohio. An annexation petition has been filed with Franklin County for this property. A service ordinance must be passed before the annexation meeting takes place before the Board of County Commissioners of Franklin County. Information regarding municipal services that would be available, should the subject site be annexed, has been compiled and is reflected in this ordinance. Should the petition be approved by the County Commissioners, a second City ordinance accepting the annexation will be required to complete the process. The time frames specified in the ORC require that this legislation be filed as emergency.

FISCAL IMPACT: The statement of municipal services and zoning conditions for a proposed annexation area has no fiscal impact. While provision of the stated services does represent cost to the City, annexation of land also has the potential to create revenue to the city.

To set forth a statement of municipal services and zoning conditions to be provided to the area contained in

a proposed annexation (AN23-016) of 22.7± Acres in Prairie Township to the city of Columbus as required by the Ohio Revised Code; and to declare an emergency.

WHEREAS, a petition for the annexation of certain territory in Prairie Township was duly filed on behalf of Francisco Anaya, Anaya Communities, LLC on July 6th, 2023; and

WHEREAS, a hearing on said petition is tentatively scheduled before the Board of County Commissioners of Franklin County on August 2, 2023; and

WHEREAS, the Ohio Revised Code requires that before said hearing the Municipal Legislative Authority shall adopt a statement indicating what services, if any, the municipal corporation will provide to the territory proposed for annexation upon annexation; and

WHEREAS, the Ohio Revised Code requires that before said meeting the Municipal Legislative Authority to adopt an ordinance stating zoning buffering conditions; and

WHEREAS, properties proposed for annexation are within the Big Darby Accord Watershed Master Plan (2006); and

WHEREAS, upon annexation, properties will have uniform access to City services as they become available; and

WHEREAS, an emergency exists in the usual daily operation of the Department of Development in that it is immediately necessary to present this ordinance to the Franklin County Board of Commissioners in accordance with the Ohio Revised Code all for the preservation of the public peace, property, health safety and welfare; **now, therefore**,

BE IT ORDAINED BY THE COUNCIL OF THE CITY OF COLUMBUS

Section 1. That the city of Columbus will provide the following municipal services for 22.7± acres in Prairie Township upon the annexation of said area to the city of Columbus:

Transportation: Maintenance will be available for any additional right-of-way that may be included in this annexation request. If this annexation contains existing signalized intersections, those intersections and signals are subject to Transportation Division Policy, which appeared in the December 6, 2003 Columbus City Bulletin, and any subsequent updates thereto.

Water: The site will be served by an existing 16” water main located in Galloway Road, the connection to which will be made the owner’s expense.

Sewers: All sanitary and storm sewers required shall be constructed privately by the owners and developers at their own cost and expense with no cost to the City.

Sanitary: DOSD has no objection regarding this annexation. The parcel is tributary to 8”, 10” and 15” sanitary sewer RP17181, the connection to which will be made the owner’s expense.

Storm: All storm sewers necessary for development/redevelopment of the area shall be designed in

accordance with design policy and zoning codes in effect at the time of development.

All sanitary and storm sewers required shall be constructed privately by the owners/developers at their own expense with no cost to the city.

Section 2. If this 22.7± acre site is annexed and if the City of Columbus permits uses in the annexed territory that the City of Columbus determines are clearly incompatible with the uses permitted under current county or township zoning regulations in the adjacent land remaining within Prairie Township, the Columbus City Council will require, in the zoning ordinance permitting the incompatible uses, the owner of the annexed territory to provide a buffer separating the use of the annexed territory and the adjacent land remaining within Prairie Township. For the purpose of this section, “buffer” includes open space, landscaping, fences, walls, and other structured elements: streets and street right-of-way; and bicycle and pedestrian paths and sidewalks.

Section 3. That for the reasons stated in the preamble hereto, which is hereby made a part hereof, this ordinance is hereby declared to be an emergency measure and shall take effect and be in force from and after its passage and approval by the Mayor or ten days after passage if the Mayor neither approves nor vetoes the same.

Legislation Number: 2231-2023

Drafting Date: 7/14/2023

Current Status: Passed

Version: 1

Matter Type: Ordinance

BACKGROUND: To authorize and direct the Director of Public Safety to enter into contract with Motorola Solutions, DBA Vigilant Solutions, to purchase license subscriptions for the Investigative Data Platform. The commercial License Plate Reader (LPR) licensing subscriptions will enable the LPRs and the Neighborhood Safety Camera systems to continue to work in conjunction with the Shot Spotter program and will help provide vital information from vehicles leaving the areas when the Division of Police is alerted by the Shot Spotter program.

Bid Information: This purchase is manifestly impractical to bid because we currently use this software and other law enforcement agencies use similar Motorola licenses, which will allow Columbus Police to share important information with other local agencies as crime often crosses jurisdictional borders. Therefore, the Division of Police is requesting a Bid Waiver in accordance with Chapter 329 of the City Code. This company is not debarred according to the Federal excluded parties listing or prohibited from being awarded a contract according to the Auditor of State unresolved findings for recovery certified search.

Contract Compliance: CC-007169

Expires 10/18/2024

Emergency Designation: Emergency legislation is necessary to make the funds available as soon as possible to prevent a break in service and to continue vital police investigations.

FISCAL IMPACT: This ordinance authorizes the Safety Director to enter into contract with Motorola Solutions, DBA Vigilant Solutions, to purchase commercial license subscriptions for the Investigative Data

Platform. Funds are available in the Law Enforcement Seizure Fund for this purchase.

To authorize the Director of the Department of Public Safety to enter into contract with Motorola Solutions, DBA Vigilant Solutions, for the purchase of commercial license subscriptions for the Investigative Data Platform; to waive the competitive bidding provisions of the Columbus City Codes; to authorize an expenditure of \$99,995.00 from the Law Enforcement Seizure Fund; and to declare an emergency (\$99,995.00)

WHEREAS, the Columbus Division of Police seeks to continue licensing this service which facilitates the ability to track vehicles leaving areas alerted by the Shot Spotter program; and,

WHEREAS, the funds for this service are available in the Law Enforcement Seizure Fund; and,

WHEREAS, it is in the City's best interest to waive the competitive bidding provisions of City Code Chapter 329 to enter into this contract; and,

WHEREAS, the Division of Police needs to enter into contract with Motorola Solutions, DBA Vigilant Solutions, for the purchase of commercial licenses for the Investigative Data Platform; and,

WHEREAS, an emergency exists in the usual daily operations of the Division of Police, Department of Public Safety, in that it is immediately necessary to authorize the Director to enter into contract for commercial license subscriptions for the Investigative Data Platform product in order to prevent a break in service and continue vital police investigations, thereby preserving the public peace, health, property, safety and welfare;

NOW, THEREFORE

BE IT ORDAINED BY THE COUNCIL OF THE CITY OF COLUMBUS:

SECTION 1. That the Director of Public Safety be and is hereby authorized to enter into contract with Motorola Solutions, DBA Vigilant Solutions, for the purchase of commercial license subscriptions for the Investigative Data Platform.

SECTION 2. That the expenditure of \$99,995.00 or so much thereof as may be needed, is hereby authorized in the Law Enforcement Seizure Fund 2219 in object class 03 Services, per the accounting codes in the attachment to this ordinance.

SECTION 3. That this Council finds that it is in the City's best interest to waive the competitive bidding provisions of Chapter 329 of the Columbus City Code to enter into the contract.

SECTION 4. That the funds necessary to carry out the purpose of this ordinance are hereby deemed appropriated, and the City Auditor shall establish such accounting codes as necessary.

SECTION 5. That the City Auditor is authorized to make any accounting changes to revise the funding source for all contracts or contract modifications associated with this ordinance and to make any accounting changes necessary to ensure that this contract is properly accounted for and recorded accurately on the City's financial records.

SECTION 6. That for reasons stated in the preamble hereto, which is hereby made a part hereof, this ordinance is hereby declared to be an emergency measure and shall take effect and be in force from and after

its passage and approval by the Mayor, or ten days after passage if the Mayor neither approves nor vetoes the same.

Legislation Number: 2242-2023

Drafting Date: 7/17/2023

Current Status: Passed

Version: 1

Matter Type: Ordinance

BACKGROUND: This legislation authorizes the Finance and Management Director to issue a purchase order and associate any and all budget reservations resulting from this legislation for computers, monitors, and accessories with the appropriate Universal Term Contract Purchase Agreement established with Brown Enterprise Solutions, LLC on behalf of the Department of Public Safety, Division of Support Services.

Bid Information: The Department of Finance and Management, through RFQ020870, awarded a bid to Brown Enterprise Solutions., LLC Ordinance 0911-2022, prepared by the Department of Finance and Management, established an option contract (UTC) with this company.

Contract Compliance: Brown Enterprise Solutions; CC010668, expires 12/31/2023

This company is not debarred according to the Excluded Party Listing System of the Federal Government or prohibited from being awarded a contract according to the Auditor of State Unresolved Findings for Recovery Certified Search.

Fiscal Impact: This ordinance authorizes an expenditure of \$179,303.12 from the Division of Support Services' general fund operating budget for the purchase of computers, monitors, and accessories for the Division of Support Services from the Universal Term Contract established by the Department of Finance and Management.

To authorize the Finance and Management Director to associate all general budget reservations resulting from this ordinance with the appropriate Universal Term Contract Purchase Agreement with Brown Enterprise Solutions, LLC for the purchase of computers, monitors, and accessories, on behalf of the Department of Public Safety, Division of Support Services; to authorize the expenditure of \$179,303.12 from the Division of Support Services' general fund operating budget. (\$179,303.12)

WHEREAS, there is a need to purchase computers, monitors, and accessories for the Division of Support Services; and,

WHEREAS, the Purchasing Office advertised and solicited formal bids and selected Brown Enterprise Solutions as the highest ranked bidder to negotiate a contract for the provision of computers, monitors, and accessories; and,

WHEREAS, it is necessary to authorize the Finance and Management Director to associate any and all general budget reservations resulting from this legislation with the appropriate Universal Term Contract established with Brown Enterprise Solutions, LLC, for the purchase of computers, monitors, and accessories for the

Division of Support Services; **now, therefore:**

BE IT ORDAINED BY THE COUNCIL OF THE CITY OF COLUMBUS:

SECTION 1. That the Finance and Management Director be and is hereby authorized to associate all general budget reservations resulting from this ordinance with the appropriate Universal Term Contract with Brown Enterprise Solutions, for the purchase of computers, monitors, and accessories for the Department of Public Safety, Division of Support Services.

SECTION 2. That the expenditure of \$179,303.12, or so much thereof as may be needed, is hereby authorized within the General Fund per the account codes in the attachment to this ordinance.

SECTION 3. That the funds necessary to carry out the purpose of this ordinance are hereby deemed appropriated, and the City Auditor shall establish such accounting codes as necessary.

SECTION 4. That the City Auditor is authorized to make any accounting changes to revise the funding source for all contracts or contract modifications associated with this ordinance.

SECTION 5. That this ordinance shall take effect and be in force from and after the earliest period allowed by law.

Legislation Number: 2243-2023

Drafting Date: 7/17/2023

Current Status: Passed

Version: 1

Matter Type: Ordinance

1. BACKGROUND

This legislation authorizes the Director of Public Service to enter into agreements with Norfolk Southern Railway Company, and other railroad companies as needed, relative to the Bridge Rehabilitation - Front St and Nationwide Blvd project.

The aforementioned effort eventually will culminate in the rehabilitation of the Front Street and Nationwide Boulevard bridges over the railroad tunnel in downtown Columbus. That scope of work necessitates that the Department of Public Service contract with Norfolk Southern Railway Company, and other railroad companies as needed, to review and approve engineering plans, design plans, construction specifications, and drawings, and other documents and work necessary to the completion of the project in order to identify and mitigate potential conflicts between rail operations and public infrastructure in proximity to railway corridors.

2. FISCAL IMPACT

Funding in the amount of \$40,000.00 is available for this project in the Streets and Highways Bond Fund, Fund 7704, within the Department of Public Service. An amendment to the 2023 Capital Improvement Budget is to provide sufficient cash and budget authority for the requisite expenditure.

3. EMERGENCY DESIGNATION

Emergency action is requested to facilitate the execution of the requisite railroad agreements as soon as reasonably practicable so as to prevent unnecessary delays in the completion and acceptance of design plans, which are expected to be finalized in mid-September.

To authorize the Director of the Department of Public Service to enter into agreements with Norfolk Southern Railway Company, and other railroad companies as needed, relative to the Bridge Rehabilitation - Front St and Nationwide Blvd project; to authorize the expenditure of up to \$40,000.00 from the Streets and Highways Bond Fund for this project; and to declare an emergency. (\$40,000.00)

WHEREAS, the Department of Public Service is administering the Bridge Rehabilitation - Front St and

Nationwide Blvd project, which will culminate in the rehabilitation of the Front Street and Nationwide Boulevard bridges over the railroad tunnel in downtown Columbus; and

WHEREAS, the aforementioned effort requires cooperation from Norfolk Southern Railway Company, which operates within the proposed project limits; and

WHEREAS, this legislation authorizes the Director of Public Service to execute agreements authorizing that entity, and other railroad companies as needed, to review and approve engineering and design plans, construction specifications and drawings, and other documents necessary to the successful completion of the planned improvements; and

WHEREAS, the estimated cost of those services is \$40,000.00; and

WHEREAS, an emergency exists in the usual daily operation of the Department of Public Service in that it is immediately necessary to authorize the execution of the requisite railroad agreements as soon as reasonably practicable so as to prevent unnecessary delays in the completion and acceptance of design plans, which are expected to be finalized in mid-September, thereby preserving the public health, peace, property, safety, and welfare; **NOW, THEREFORE,**

BE IT ORDAINED BY THE COUNCIL OF THE CITY OF COLUMBUS:

SECTION 1. That the 2023 Capital Improvement Budget authorized by Ordinance 1711-2023 be and is hereby amended to provide sufficient budget authority for the appropriate project authorized within this ordinance as follows:

Fund / Project / Project Name / Current / Change / Amended

7704 / P530301-260275 / Bridge Rehabilitation - Front Street over Conrail South of Nationwide (Voted Carryover) / \$250,000.00 / (\$40,000.00) / \$210,000.00

7704 / P530301-260755 / Bridge Rehabilitation - Front St and Nationwide Blvd over RR Tunnel (Voted Carryover) / \$520,782.00 / \$40,000.00 / \$560,782.00

SECTION 2. That the Director of Public Service be and is hereby authorized to execute agreements with Norfolk Southern Railway Company, and other railroad companies as needed, for the purpose of authorizing those entities to review and approve engineering and design plans, construction specifications and drawings, and other documents and work necessary to the completion of the Bridge Rehabilitation - Front St and Nationwide Blvd project.

SECTION 3. That the expenditure of \$40,000.00, or so much thereof as may be needed, is hereby authorized in Fund 7704 (Streets and Highways Bond Fund), Dept-Div 5911 (Division of Infrastructure Management), Project P530301-260755 (Bridge Rehabilitation - Front St and Nationwide Blvd project), Object Class 06 (Capital Outlay) per the accounting codes in the attachment to this Ordinance.

SECTION 4. That the funds necessary to carry out the purpose of this ordinance are hereby deemed appropriated, and the City Auditor shall establish such accounting codes as necessary.

SECTION 5. That the City Auditor is authorized to make any accounting changes to revise the funding source for all contracts or contract modifications associated with this Ordinance.

SECTION 6. That the City Auditor is hereby authorized to transfer the unencumbered balance in a project account to the unallocated balance account within the same fund upon receipt of certification by the Director of the Department administering said project that the project has been completed and the monies are no longer required for said project.

SECTION 7. That for the reasons stated in the preamble hereto, which is made a part hereof, this Ordinance is declared to be an emergency measure and shall take effect and be in force from and after its passage and approval by the Mayor, or ten (10) days after passage if the Mayor neither approves nor vetoes this Ordinance.

Legislation Number: 2250-2023

Drafting Date: 7/18/2023

Current Status: Passed

Version: 1

Matter Type: Ordinance

BACKGROUND: This ordinance authorizes the Director of Public Safety to enter into a contract with Morpho USA DBA Idemia Identity & Security USA, LLC, formally Morpho Trak, Inc., to continue maintenance and service for the upgrade and technical support of the Automated Fingerprint Identification System (AFIS) for the Division of Police.

The City of Columbus entered into an agreement with Morpho Trak, Inc. in 2015 to upgrade AFIS which was at approximately 90 percent capacity on fingerprint inventory. The agreement required the city to make lease payments to the vender over an eleven year period to cover the cost of the upgrade as well as to provide maintenance and technical support of the new system for the duration of the agreement. The upgraded system, completed in 2016, provides technology that increases the Division's latent fingerprint accuracy, meaning it provides the Division tools to help identify suspects quickly and more accurately. The Division of Police is able to query searches to multiple agencies and databases which includes wanted person, persons of special interest, sexual offenders, and terrorist watch lists.

Bid Information: The initial contract was awarded pursuant to the sole source provisions of Chapter 329 of Columbus City Code due to the proprietary nature of AFIS technology, and the prohibitive cost of conversion to a different system.

This company is not debarred according to the Federal excluded parties listing or prohibited from being awarded a contract according to the Auditor of State unresolved findings for recovery certified search.

Contract Compliance No.: CC028279 thru 3-5-2024

EMERGENCY DESIGNATION: Emergency legislation is requested for this ordinance so that there are maintenance and service available for the Automated Fingerprint Identification System (AFIS) which is a critical and necessary investigative tool services used in daily operations may continue to be received uninterrupted.

FISCAL IMPACT: This ordinance authorizes an expenditure of \$983,423.00 to continue payments for the upgraded Automated Fingerprint Identification System (AFIS). The General Fund and Special Income Tax Fund will be used for this expenditure. A total of \$991,703.00 was encumbered and spent in the first year of this upgrade for the maintenance and upgrade of the system. The total cost of the AFIS upgrade will be \$10.6 million, funded over an eleven (11) year period pursuant to Ordinance 2715-2015. Half the cost of the entire system will be reimbursed by Franklin County pursuant to Ordinance 2695-2015. The City of Columbus will fund the annual cost of the AFIS upgrade and then receive reimbursement from Franklin County for their half of the cost. This is year eight (8) of the eleven (11) year period.

To authorize the Director of the Department of Public Safety to enter into contract with Idemia Identity & Security USA, LLC., to continue payments for the upgraded Automated Fingerprint Identification System (AFIS) for the Division of Police in accordance with the sole source provisions of the Columbus City Codes; to authorize the appropriation of \$491,711.50 within the Special Income Tax Debt Fund; to authorize an expenditure of \$983,423.00 from the General Fund and Special Income Tax Fund; and to declare an emergency. (\$983,423.00)

WHEREAS, it is necessary to authorize the appropriation of funds within the Special Income Tax Debt Fund; and,

WHEREAS, the Division of Police needs to continue to make annual payments to Idemia Identity & Security USA, LLC. for the upgraded Automated Fingerprint Identification System (AFIS); and,

WHEREAS, the upgrade to AFIS was conducted in accordance with sole source provisions of Chapter 329 due to the proprietary nature of the technology and prohibitive cost of conversion to a different system and fingerprint database; and,

WHEREAS, AFIS is an invaluable tool for law enforcement in the identification of fingerprints; and,

WHEREAS, the City of Columbus will be reimbursed by the Franklin County Commissioners for half the annual cost of this upgrade; and,

WHEREAS, an emergency exists in the usual daily operation of the Department of Public Safety, Division of Police, to authorize the Director to enter into a contract for maintenance and service with Idemia Identity & Security USA, LLC so that critical and necessary investigative tool services used in daily operations may continue to be received uninterrupted, thereby preserving the public peace, property, health, safety and welfare; **NOW, THEREFORE**,

BE IT ORDAINED BY THE COUNCIL OF THE CITY OF COLUMBUS:

SECTION 1. That the Director of Public Safety be and is hereby authorized to enter into contract with Idemia Identity & Security USA, LLC., for the upgrade of the Automated Fingerprint Identification System (AFIS) for the Division of Police, Department of Public Safety in accordance with the sole source provisions of Columbus City Code.

SECTION 2. That from the unappropriated monies in the Special Income Tax Debt Fund No. 4430, and from all monies estimated to come into said fund from any and all sources and unappropriated for any other purpose during the fiscal year ending December 31, 2023, the sum of \$491,711.50 is appropriated to the Division of Police, Department of Public Safety per the accounting codes attached to this legislation.

SECTION 3. That the expenditure of up to \$491,711.50, or so much as thereof as may be needed, be and is hereby authorized from the Special Income Tax Debt Fund and that the expenditure of up to \$491,711.50 or so much thereof as may be needed, be and is hereby authorized from the Division of Police General Fund, to pay Idemia Identity & Security USA, LLC., for the upgrade of the Automated Fingerprint Identification System (AFIS) per the accounting codes attached to this legislation for a total expenditure of \$983,423.00.00.

SECTION 4. That said agreement shall be awarded in accordance with sole source provisions of City Code Chapter 329.

SECTION 5: That the monies in the foregoing sections shall be paid upon order of the Director of Public Safety and that no order shall be drawn or money paid except by voucher, the form of which shall be approved by the City Auditor.

SECTION 6. That the funds necessary to carry out the purpose of this ordinance are hereby deemed appropriated, and the City Auditor shall establish such accounting codes as necessary.

SECTION 7. That the City Auditor is authorized to make any accounting changes to revise the funding source for all contracts or contract modifications associated with this ordinance and to make any accounting changes necessary to ensure that this contract is properly accounted for and recorded accurately on the City's financial

records.

SECTION 8. That for reasons stated in the preamble hereto, which is hereby made a part thereof, this ordinance is hereby declared to be an emergency measure and shall take effect and be in force from and after its passage and approval by the Mayor, or ten days after passage if the Mayor neither approves nor vetoes the same.

Legislation Number: 2258-2023

Drafting Date: 7/18/2023

Current Status: Passed

Version: 1

Matter Type: Ordinance

BACKGROUND: This legislation authorizes the Finance and Management Director to establish a Universal Term Contract (UTC) for the option to purchase 300 Gallon Refuse Containers with Tank Holding Corp. dba Snyder Industries Inc. The Division of Refuse is the sole user of refuse containers. Three Hundred Gallon Refuse Containers and replacement parts are used in alleys within residential areas throughout the City. The term of the proposed option contract would be approximately two years, expiring July 1, 2025, with the option to renew for two (2) additional one (1) year periods. The Purchasing Office opened formal bids on June 22, 2023. In addition, the expenditure of \$1.00 is hereby authorized from General Budget Reservation BRPO002253.

The Purchasing Office advertised and solicited competitive bids in accordance with the relevant provisions of Section 329 relating to competitive bidding Request for Quotation No. RFQ025032. One (1) bid was received.

The Purchasing Office is recommending award to the overall, responsive, responsible and best bidder as follows:

Tank Holding Corp. dba Snyder Industries Inc, CC# 040495 expires 12/28/2023, All items, \$1.00
Total Estimated Annual Expenditure: \$300,000.00, Division of Refuse, the sole user

Emergency Designation: The Finance and Management Department respectfully requests this legislation to be considered an emergency as the previous contract expired June 30, 2023 and a contract is needed to ensure that 300 gallon refuse containers are available to service the City of Columbus.

The company is not debarred according to the Excluded Party Listing System of the Federal Government or prohibited from being awarded a contract according to the Auditor of State Unresolved Findings for Recovery Certified Search.

FISCAL IMPACT: The expenditure of \$1.00 is hereby authorized from General Budget Reservation BRPO002253. City Agencies will be required to obtain approval to expend from their own appropriations for their estimated annual expenditures.

To authorize the Finance and Management Director to enter into a Universal Term Contract for the option to purchase 300 Gallon Refuse Containers with Tank Holding Corp. dba Snyder Industries Inc.; to authorize the expenditure of \$1.00; and to declare an emergency. (\$1.00).

WHEREAS, the 300 Gallon Refuse Containers UTC will provide for the purchase of Refuse containers, lids, and replacement parts used to provide refuse services in residential alleys; and

WHEREAS, the Purchasing Office advertised and solicited formal bids on June 22, 2023 and selected the overall lowest, responsive, responsible and best bidder; and

WHEREAS, an emergency exists in the usual daily operation of the Public Service Department in that it is necessary to immediately enter into a contract for the option to purchase 300 Gallon Refuse Containers as the previous contract expired June 30, 2023 and a contract is needed to ensure that 300 gallon refuse containers are available to service the City of Columbus. thereby preserving the public health, property, and welfare; **NOW, THEREFORE**,

BE IT ORDAINED BY THE COUNCIL OF THE CITY OF COLUMBUS:

SECTION 1. That the Finance and Management Director is hereby authorized to enter into the following contract for the option to purchase 300 Gallon Refuse Containers in accordance with Request for Quotation RFQ025032 for a term of approximately two years, expiring July 1, 2025, with the option to renew for two (2) additional one (1) year periods, as follows:

Tank Holding Corp. dba Snyder Industries Inc., All items, \$1.00

SECTION 2. That the expenditure of \$1.00 is hereby authorized from General Budget Reservation BRPO002253 of this ordinance to pay the cost thereof.

SECTION 3. That the funds necessary to carry out the purpose of this ordinance are hereby deemed appropriated, and the City Auditor shall establish such accounting codes as necessary.

SECTION 4. That for the reason stated in the preamble hereto, which is hereby made a part hereof, this ordinance is hereby declared to be an emergency measure and shall take effect and be in force from and after its passage and approval by the Mayor, or ten days after passage if the Mayor neither approves nor vetoes the same.

Legislation Number: 2262-2023

Drafting Date: 7/19/2023

Version: 1

Current Status: Passed

Matter Type: Ordinance

BACKGROUND: This legislation authorizes the Director of the Department of Development to enter into a Beneficiary Grant Agreement with Besa Community Inc. (Besa), a non-profit organization, in an amount up to \$300,000.00, and to authorize payment of operational expenses starting January 1, 2023, using federal American Rescue Plan Act (ARPA) funds to support and increase their organizational capacity to service disproportionately impacted census tracts.

Ordinance No. 1201-2021 authorized the City of Columbus to accept and appropriate approximately \$187,030,138.00 of federal American Rescue Plan Act (ARPA) funds as signed into law by the President of

the United States on March 11, 2021.

Besa is a not-for-profit organization that coordinates community-wide service projects, manages citywide drives to educate and connect people to community resources, and partners with businesses and other not-for-profits to connect volunteers to communities in need. At the onset of the pandemic, Besa's response plan was to mobilize and direct resources to where they were needed most. COVID-19's impact on communities of color and communities with concentrated poverty has only exacerbated the divide and the basic needs of those communities already suffering with food insecurity, housing instability, infant mortality, and health disparities. This funding will allow Besa to continue to help those communities and people still experiencing the negative impact of COVID-19 in need in 2023. The majority of Besa's work will take place in the Near East, the Hilltop, Franklinton, Linden, and smaller neighborhoods in or adjacent to Downtown.

If the guidance from the U.S. Department of Treasury is modified while this Beneficiary Grant Agreement is in effect, it is requested that the Director of Development be given the authority to modify the terms and conditions of the Beneficiary Agreement without seeking additional Council approval in order to align with the most current version of the laws, regulations, and guidance.

Emergency action is requested to address the continued impacts of the COVID-19 health emergency and to assure that operational support funding is available for this agency so they can maintain the organizational capacity to serve disproportionately impacted census tracts continuing to suffer from food insecurity, housing instability, infant mortality, and health disparities.

FISCAL IMPACT: Funding is provided to the City of Columbus from the American Rescue Plan Act passed by Congress and signed into law March 11, 2021.

CONTRACT COMPLIANCE: The vendor number is 040045 and expires 11/02/2023.

..Title

To authorize the Director of the Department of Development to enter into a Beneficiary Grant Agreement with Besa Community Inc., in an amount up to \$300,000.00, using federal American Rescue Plan Act (ARPA) funds to support and increase the organizational capacity of the not-for-profit to service disproportionately impacted census tracts and to pay for operational expenses starting January 1, 2023; to authorize the Director of the Department of Development to modify the terms and conditions of the Beneficiary Grant Agreement as needed without seeking further City Council approval in order to align with the most current version of the laws, regulations, and guidance; to authorize the expenditure of up to \$300,000.00 of ARPA funds; and to declare an emergency. (\$300,000.00)

To authorize the Director of the Department of Development to enter into a Beneficiary Grant Agreement with Besa Community Inc., in an amount up to \$300,000.00, using federal American Rescue Plan Act (ARPA) funds to support and increase the organizational capacity of the not-for-profit to service disproportionately impacted census tracts and to pay for operational expenses starting January 1, 2023; to authorize the Director of the Department of Development to modify the terms and conditions of the Beneficiary Grant Agreement as needed without seeking further City Council approval in order to align with the most current version of the laws, regulations, and guidance; to authorize the expenditure of up to \$300,000.00 of ARPA funds; and to declare an emergency. (\$300,000.00)

WHEREAS, the Director of the Department of Development desires to enter into a Beneficiary Grant Agreement with Besa Community Inc., a non-profit entity, to provide support and increase their organizational capacity to service disproportionately impacted census tracts and authorize the payment of expenses beginning January 1, 2023; and

WHEREAS, Besa Community Inc., works to assure that many non-profit organizations have the capacity to meet their growing needs; and

WHEREAS, disproportionately impacted census tracts have a much greater need than anticipated because of COVID-19, especially regarding food insecurities, housing instability, infant mortality, and health disparities; and

WHEREAS, the COVID-19 pandemic has resulted in negative economic impacts on not-for-profit organizations; and

WHEREAS, expenditure of ARPA funding to support costs incurred by not-for-profit organizations beginning on March 3, 2021, is necessary to alleviate the continued negative impacts caused by the COVID-19 public health emergency; and

WHEREAS, such expenditure of funds has not been previously accounted for in the 2023 Budget; and

WHEREAS, an emergency exists in the usual daily operation of the Department of Development to address the continued impacts of the COVID-19 health emergency and to assure that operational support funding is available for this agency so they can maintain the organizational capacity to serve disproportionately impacted census tracts continuing to suffer from food insecurity, housing instability, infant mortality, and health disparities, such immediate action is necessary for the preservation of the public health, peace, property, safety and welfare; **NOW, THEREFORE,**

BE IT ORDAINED BY THE COUNCIL OF THE CITY OF COLUMBUS:

SECTION 1. That the Director of the Department of Development is authorized to enter into a Beneficiary Grant Agreement with Besa Community Inc., in an amount up to \$300,000.00, using federal American Rescue Plan Act (ARPA) funds for operational support in disproportionately impacted census tracts and is authorized to make payments for such operational expenses incurred starting January 1, 2023.

SECTION 2. That for the purpose stated in Section 1, the Director of the Department of Development is authorized to modify the terms and conditions of the Beneficiary Grant Agreement as needed without seeking further City Council approval in order to align with the most current version of the laws, regulations, and guidance.

SECTION 3. That for the purpose stated in Section 1, the expenditure of \$300,000.00 or so much thereof as may be needed, is hereby authorized in Fund 2209 (ARPA), Dept-Div 44-01 (Administration), in object class 05 (Other) per the accounting codes in the attachment to this ordinance.

SECTION 4. That the funds necessary to carry out the purpose of this ordinance are hereby deemed appropriated and the City Auditor shall establish such accounting codes as necessary.

SECTION 5. That the City Auditor is authorized to make any accounting changes to revise the funding source for all contracts or contract modifications associated with this ordinance.

SECTION 6. For the reasons stated in the Preamble hereto, which is hereby made a part hereof, this Ordinance is hereby declared to be an emergency measure and shall take effect and be in force from and after passage and approval by the Mayor or ten days after passage if the Mayor neither approves nor vetoes the same.

Legislation Number: 2263-2023

Drafting Date: 7/19/2023

Current Status: Passed

Version: 1

Matter Type: Ordinance

BACKGROUND: This legislation authorizes the Finance and Management Director to issue a purchase order to Heritage Fire Equipment to repair Columbus Fire Engine 24, which is in need of body repairs. A quote from the manufacturer's authorized repair dealer, Heritage Fire Equipment, has been received and approved by Fleet Management to commence repairs.

Bid Information: Universal Term Contract ~ Heritage Fire Equipment / Vendor 024589 / PA006291

Emergency Designation: This legislation is to be declared an emergency measure so that the repairs of this front line response apparatus may commence as soon as possible, and avoid any supply chain delays.

FISCAL IMPACT: This ordinance authorizes an expenditure of \$109,092.50 for the purchase of body repairs needed on Columbus Fire Division Engine 24. Funds are available within the Fire Division's Safety Bond Fund for repair service.

To authorize the Director of the Department of Finance and Management to issue a purchase order to Heritage Fire Equipment for body repairs for Fire Engine 24 in accordance with the universal term contract established for such purpose; to authorize the expenditure of \$109,092.50 from the Safety Bond Fund; and to declare an emergency. (\$109,092.50)

WHEREAS, the Division of Fleet Management needs to complete repairs for Engine 24 from Heritage Fire Equipment on behalf of the Division of Fire in accordance with the universal term contract established for such purpose; and

WHEREAS, this ordinance authorizes the Director of Finance and Management to issue a purchase order to Heritage Fire Equipment on behalf of the Division of Fire for the aforementioned repairs; and

WHEREAS, an emergency exists in the usual daily operations of the Division of Fire, Department of Public Safety, in that it is immediately necessary to authorize the Director of Finance and Management to issue a purchase order to Heritage Fire Equipment for repairs to Columbus Fire Engine 24 to allow for its continued operation, for the preservation of the public health, peace, property, safety, and welfare; **NOW, THEREFORE**

BE IT ORDAINED BY THE COUNCIL OF THE CITY OF COLUMBUS:

SECTION 1. That the Director of Finance and Management is hereby authorized to issue a purchase order on behalf of the Division of Fire to Heritage Fire Equipment for the purchase of repairs for Columbus Fire Engine 24.

SECTION 2. That the expenditure of \$109,092.50, or so much thereof as may be necessary for the purchase of these repairs, be and is hereby authorized from the Safety Bond Fund, per the accounting codes in the attachment to this ordinance.

SECTION 3. That the City Auditor is authorized to establish proper accounting project numbers, and to make any accounting changes to revise the funding source for any contract or contract modification associated with the expenditure of funds transferred in Sections 1 and 2, above.

SECTION 4. That the City Auditor is hereby authorized to transfer the unencumbered balance in a project account to the unallocated balance account within the same fund upon receipt of certification by the Director of the Department administering said project that the project has been completed and the monies are no longer required for said project.

SECTION 5. That all funds necessary to carry out the purpose of this ordinance are hereby deemed appropriated, and the City Auditor shall establish such accounting codes as necessary.

SECTION 6. That for the reasons stated in the preamble hereto, which is hereby made a part hereof, this ordinance is hereby declared an emergency measure and shall take effect and be in force from and after its passage and approval by the Mayor, or ten days after passage if the Mayor neither approves nor vetoes the same.

Legislation Number: 2264-2023

Drafting Date: 7/19/2023

Current Status: Passed

Version: 1

Matter Type: Ordinance

BACKGROUND: This legislation authorizes the Finance and Management Director to issue a purchase order to The WW Williams Company LLC in accordance with the universal term contract established for such purpose to replace the blown engine in Columbus Fire Engine XE-25; a quote from the manufacturer's authorized repair dealer, The WW Williams Company LLC, has been received and approved by Fleet Management to commence these emergency engine replacement services.

Bid Information: Universal Term Contract ~ The WW Williams Company LLC / Vendor 020988 / PA004816

Emergency Designation: This legislation is to be declared an emergency measure so that the engine replacement in this front line response apparatus may commence as soon as possible, and avoid any supply chain delays.

FISCAL IMPACT: This ordinance authorizes an expenditure of \$47,978.91 for the purchase of engine replacement services needed on Columbus Fire Division Engine XE-25. Funds are available within the Fire Division's Safety Bond Fund for repair service; an amendment to the 2023 CIB and a transfer of funds is required to fund this service; this amendment is contingent upon approval of the 2023 Capital Improvement Budget.

To authorize a transfer between projects within the Safety Bond Fund and to amend the 2023 Capital Improvements Budget; to authorize the Director of Finance and Management to issue a purchase order to The WW Williams Company LLC for engine replacement services for Fire Engine XE-25 in accordance with the universal term contract established for such purpose; to authorize the expenditure of \$47,978.91 from the Safety Bond Fund; and to declare an emergency. (\$47,978.91)

WHEREAS, it is necessary to amend the 2023 Capital Improvement Budget within the Safety Bond Fund; and

WHEREAS, this amendment is contingent upon approval of the 2023 Capital Improvement Budget; and

WHEREAS, it is necessary to transfer funds within Public Safety's Capital Improvement Budget to properly align cash with projected expenditure; and

WHEREAS, the Division of Fleet Management needs to complete engine replacement services for Columbus Fire Engine XE-25 from The WW Williams Company LLC on behalf of the Division of Fire in accordance with the universal term contract established for such purpose; and

WHEREAS, this ordinance authorizes the Director of Finance and Management to issue a purchase order to The WW Williams Company LLC on behalf of the Division of Fire for the aforementioned engine replacement services; and

WHEREAS, an emergency exists in the usual daily operations of the Division of Fire, Department of Public Safety, in that it is immediately necessary to authorize the Director of Finance and Management to issue a purchase order to The WW Williams Company LLC for engine replacement to Columbus Fire Engine XE-25 to allow for its continued operation, for the preservation of the public health, peace, property, safety, and welfare; **NOW, THEREFORE**

BE IT ORDAINED BY THE COUNCIL OF THE CITY OF COLUMBUS:

SECTION 1. That the City Auditor is hereby authorized and directed to transfer said funds within the Safety Voted Bond Fund per the account codes in the attachment to this ordinance at such time as is deemed necessary by the City Auditor, and to expend said funds, or so much thereof as may be necessary.

SECTION 2. That the 2023 Capital Improvement budget (Ordinance 1711-2023) is hereby amended as follows in order to provide sufficient budget authority for this ordinance; this amendment is contingent upon approval of the 2023 Capital Improvement Budget.

Fund / Project / Project Name / Current / Amended / Change

7701 / P340152-100000 / Fire Apparatus Replacement - Engines (Voted Carryover) / \$170,035 / \$207,072 / +\$37,037

7701 / P340150-100000 / Fire Apparatus Replacement Medics (Voted Carryover) / \$245,615 / \$208,578 / (\$37,037)

SECTION 3. That the Director of Finance and Management is hereby authorized to issue a purchase order on behalf of the Division of Fire to The WW Williams Company LLC for the purchase of engine replacement for Columbus Fire Engine XE-25.

SECTION 4. That the expenditure of \$47,978.91, or so much thereof as may be necessary for the purchase of

this engine replacement, be and is hereby authorized from the Safety Bond Fund, per the accounting codes in the attachment to this ordinance.

SECTION 5. That the City Auditor is authorized to establish proper accounting project numbers, and to make any accounting changes to revise the funding source for any contract or contract modification associated with the expenditure of funds transferred in Sections 1 and 2, above.

SECTION 6. That the City Auditor is hereby authorized to transfer the unencumbered balance in a project account to the unallocated balance account within the same fund upon receipt of certification by the Director of the Department administering said project that the project has been completed and the monies are no longer required for said project.

SECTION 7. That all funds necessary to carry out the purpose of this ordinance are hereby deemed appropriated, and the City Auditor shall establish such accounting codes as necessary.

SECTION 8. That for the reasons stated in the preamble hereto, which is hereby made a part hereof, this ordinance is hereby declared an emergency measure and shall take effect and be in force from and after its passage and approval by the Mayor, or ten days after passage if the Mayor neither approves nor vetoes the same.

Legislation Number: 2265-2023

Drafting Date: 7/19/2023

Current Status: Passed

Version: 1

Matter Type: Ordinance

BACKGROUND

The purpose of this ordinance is to amend Chapter 111 of the Columbus City Codes to allow Council to hold virtual meetings and allow virtual attendance to otherwise in-person meetings and hearings.

With the onset of the COVID pandemic, quarantine and social distancing became not only household terms, but best practices. However, there was the possibility that public meetings could not be conducted in Columbus, as prescribed by the state, without potentially spreading the virus. Ohio law places strict mandates on elected and appointed members of public bodies being in-person to conduct business in meetings. Though the state legislature did pass temporary exemptions to these mandates, the City remains subject to the sunsets of these exemptions, given that we must follow the general laws of the state. However, home rule allows for local exceptions to state statute in this situation. Other cities in Ohio, including Cleveland in 2021, have allowed for Council ordinance to determine the need for virtual meetings.

In July 2022, the decennial Columbus Charter Review Commission recommended a charter amendment that would allow Council to conduct virtual meetings. Council placed this recommended amendment on the November 2022 ballot, when it was passed overwhelmingly by Columbus residents. It is now incumbent on Council to effectuate this charter change with an amendment to the City Codes that establishes how Council may allow for virtual meetings. The amendment does the following:

- Allows Council to hold meetings & hearings in-person, virtually, or a combination of the two
- Establishes the means by which Council may hold virtual meetings & hearings
- Establishes that such meetings and hearings are to be conducted in such a way as to ensure that members of the public are able to observe and hear the public discussions and deliberations of all the members of Council, whether members are attending in-person or virtually

This amendment will give Council the flexibility to conduct the business of the City, while also remaining accountable and accessible to all City residents.

To amend chapter 111 of the Columbus City Codes, pertaining to the ability of Council to hold virtual meetings.

WHEREAS, throughout the COVID pandemic, Council conducted the business of the City according to the recommendations of public health officials, which involved meeting in a virtual format; and,

WHEREAS, after June 2022, the state exemption that allowed for public bodies to meet virtually expired; and,

WHEREAS, home rule allows for municipalities to establish their own rules in Charter and Code for how they conduct open meetings; and,

WHEREAS, in November 2022, Columbus voters overwhelmingly approved an amendment to the City Charter to allow Council, by ordinance, to establish means by which to meet virtually; and,

WHEREAS, this amendment to the Columbus City Codes will give Council the flexibility to conduct the business of the City, while also remaining accountable and accessible to all City residents; **NOW, THEREFORE,**

BE IT ORDAINED BY THE COUNCIL OF THE CITY OF COLUMBUS:

SECTION 1. That chapter 111 of the Columbus City Codes is hereby amended as follows:

111.01 - ~~Regular Council meetings and hearings.~~

(A) In accordance with Section 8 of the City Charter, or by ordinance or resolution, regular meetings of council shall be held virtually or in the usual place for holding meetings on Monday of each week at 5:00 p.m. with zoning committee meetings beginning at 6:30 p.m. except during the month of August, and except when such meeting day falls on a holiday established by ordinance. The council president may establish an alternative date, ~~and time, and location~~ of the meetings of council and the committees thereof on a case by case basis if the council president determines that it is necessary to designate an alternative meeting date, ~~and time, or location~~ so long as proper notice is given.

(B) Meetings and hearings may be held in-person, virtually, or a combination of the two. Council may conduct virtual meetings and hearings by means of teleconference, video conference, or any other similar technology. Virtual meetings and hearings shall be conducted in such a way as to ensure that members of the public are able to observe and hear the public discussions and deliberations of all the members of Council, whether members are attending in-person or virtually. Each member attending virtually shall be considered present as if the member is in-person at the public meeting or hearing, shall be permitted to vote, and shall be counted for purposes of determining whether a quorum is present at the meeting or hearing. Any vote on a resolution, ordinance, motion, or formal action of any kind cast by a member attending virtually shall have the same effect as if the member were attending the public meeting or hearing in-person.

(C) A representative of the city attorney, auditor, city treasurer, and each department shall attend all council

meetings and give necessary service and advice; provided, however, that the president of the council, may excuse any or all of said representatives from attending any council meeting when it appears to from the calendar that the matters to be considered at a particular meeting will not require their services.

(D) Any member of city council may attend any and all meetings of the city council, its standing committees created by the president, or the council itself, including all such meetings which may be conducted in executive session.

(E) The minutes of meetings or hearings of the Council or any of its committees shall be promptly prepared, filed, and maintained and shall be open to public inspection in accordance with the general laws of the state. The minutes need only reflect the general subject matter of discussions in executive sessions. Where a full video recording with audio of a meeting or hearing has been preserved as a public record, written meeting minutes are not required.

SECTION 2. That existing chapter 111 of the Columbus City Codes is hereby repealed.

SECTION 3: That this ordinance shall take effect and be in force from and after the earliest period allowed by law.

Legislation Number: 2266-2023

Drafting Date: 7/19/2023

Current Status: Passed

Version: 1

Matter Type: Ordinance

This legislation authorizes the Director of the Department of Technology (DoT) to enter into a non-profit services contract in an amount up to \$610,000.00 with Smart Columbus LLC. Smart Columbus LLC is the non-profit organization created to continue the efforts of the Smart Columbus US Department of Transportation Grant.

This contract is in addition to, and provides additional funds, to continue work authorized by ordinances 3301-2021, 0670-2022 and 2657-2022. The first two ordinances authorized contracts between the Development Director and Smart Columbus. The third contract authorized a contract between the Director of the Department of Technology and Smart Columbus.

The Department of Technology, in alignment with the Franklin County Digital Equity Coalition, are partnering with Smart Columbus to establish a program management office to advance the digital equity action agenda with a diverse set of stakeholders and partners. Funds authorized by this legislation will be used to:

- facilitate and administer the Digital Equity Coalition; and
- build the digital equity team dedicated to this work; and
- execute pilot programs in alignment with the Digital Equity Action Agenda; and
- build momentum around the coalition, awareness among community organizations and residents; and
- implement brand strategy.

Specific activities to be undertaken to achieve the above noted goals are:

- Community Management and Coalition Building, to include-
 - o General coordination meetings, regular touch bases with individual organizations, and in person “convenings” that activate Digital Equity Coalition members in alignment with the Action Agenda.
 - o Expansion of coalition membership and community awareness of the digital divide.
 - o Implementation of resident facing campaigns and messaging that is shared and utilized across community organizations and institutions.
 - o Presentations for community groups to build support for the action agenda and produce deliverables that answer resident and community leader questions and concerns.

- o Human-centered research to evaluate pilot performance and evolve design of new programs.
- o Pilot Scoping & Execution, with overall program management support, to facilitate partner collaboration, engage experts, and complete associate deliverables to-
 - o Run a digital skills pilot to test the efficacy and impact of courses aligned to the Learning Framework and deployed in a decentralized model that can scale across the region; distribute devices to participants upon completion.
 - o Create and evaluate the effectiveness of a unique donation, refurbishment, and distribution process that will meet our community region’s need for high quality, low-cost digital devices.

This ordinance also authorizes the appropriation of \$610,000.00 to the Department of Technology, Information Services Division, from the unappropriated cash balance of the Information Services Operating Fund. Finally, this ordinance authorizes the expenditure of \$610,000.00 from the Department of Technology, Information Services Operating Fund.

The services included in this agreement cannot be provided by existing city employees because these services are beyond the City’s current staffing capacity to provide.

FISCAL IMPACT

Funds are budgeted and available in the above-stated Operating Fund, pending the above-described appropriation of \$610,000.00.

To appropriate \$610,000.00 to the Department of Technology, Information Services Division, from the unappropriated cash balance of the Information Services Operating Fund; to authorize the Director of the Department of Technology to enter into a non-profit services contract with Smart Columbus LLC in an amount up to \$610,000.00 to support the ongoing efforts and work of the Smart Columbus organization; and to authorize the expenditure of \$610,000.00 from the Information Services Operating Fund. (\$610,000.00)

WHEREAS, Smart Columbus LLC, a non-profit organization, was created following award of a grant by the US Department of Transportation; and

WHEREAS, the city’s Department of Technology desires to enter into contract with Smart Columbus, LLC to continue to support plans and activities related to the City’s broadband and digital equity initiatives with Smart Columbus and also to study and plan further efforts to scale solutions that close the digital divide in the city; and

WHEREAS, it is necessary to authorize the Director to enter into contract with Smart Columbus LLC so that Smart Columbus LLC can continue to find ways to provide affordable and quality internet to opportunity neighborhoods in the city without delay, for the preservation of the public health, peace, property and safety;

NOW, THEREFORE,

BE IT ORDAINED BY THE COUNCIL OF THE CITY OF COLUMBUS:

SECTION 1. That the sum of \$610,000.00 be and is hereby appropriated to the Department of Technology, Information Services Operating Fund from the unappropriated cash balance of the Information Services Operating Fund for the purpose stated in this ordinance and as provided in the attachment to this ordinance (see 2266-2023EXP).

SECTION 2. That the Director of the Department of Technology is hereby authorized to enter into a non-profit services agreement with Smart Columbus, LLC to provide services to support plans and activities related to the City’s broadband and digital equity initiatives with Smart Columbus and also to study and plan further efforts to scale solutions that close the digital divide in the city at a cost of up to \$610,000.00

SECTION 3. That the expenditure of \$610,000.00, or so much thereof as may be needed, is hereby authorized as shown in the attachment to this ordinance. (see 2266-2023EXP)

SECTION 4. That this contract is awarded in accordance with the relevant provisions of City Code Chapter 329 relating to not-for-profit service contracts.

SECTION 5. That the City Auditor is authorized to make any accounting changes to revise the funding source for all contracts or contract modifications associated with this ordinance.

SECTION 6. That the funds necessary to carry out the purpose of this ordinance are hereby deemed appropriated, and the City Auditor shall establish such accounting codes as necessary.

SECTION 7. That this ordinance shall take effect and be in force from and after the earliest period allowed by law.

Legislation Number: 2268-2023

Drafting Date: 7/19/2023

Current Status: Passed

Version: 1

Matter Type: Ordinance

BACKGROUND:

This ordinance authorizes the Director of the Department of Development to execute a Grant Agreement with Rebuilding Together Central Ohio dba ModCon Living, in an amount up to \$270,000.00 in support of a newly established neighborhood-specific home repair program in the North Central area.

ModCon Living assists homeowners through unique programs and services that help to sustain homes, improve quality of life and preserve affordable homeownership - Building Strong Neighborhoods and Pathways Out of Poverty; keeping vulnerable homeowners in the City of Columbus warm, safe, and dry in their homes.

Approval is also requested for reimbursement of expenses incurred prior to execution of the purchase order, starting August 1, 2023.

FISCAL IMPACT: Funding is available within the Neighborhood Initiatives Subfund (100018) for \$270,000.00.

To authorize the Director of Development to execute a Grant Agreement with Rebuilding Together Central Ohio dba ModCon Living, in an amount up to \$270,000.00 towards providing home repair services to residents of the North Central community; and to authorize an appropriation and expenditure of \$270,000.00 within the Neighborhood Initiatives Subfund; and to authorize reimbursement of expenses incurred prior to execution of the purchase order. (\$270,000.00)

WHEREAS, it is a top priority of Columbus City Council to support efforts that build strong neighborhoods, promote the creation of good-paying jobs, and develop pathways out of poverty; and

WHEREAS, ModCon Living assists homeowners through unique programs and services that help to sustain homes, improve quality of life and preserve affordable homeownership; and

WHEREAS, ModCon Living seeks to provide the community with various home repair services; and

WHEREAS, the Director of Development desires to enter into a Grant Agreement with Rebuilding Together Central Ohio dba ModCon Living;

WHEREAS, program expenses incurred prior to execution of the purchase order, starting August 1, 2023, will be reimbursed; **NOW, THEREFORE,**

BE IT ORDAINED BY THE COUNCIL OF THE CITY OF COLUMBUS:

SECTION 1. That the Director of the Department of Development is hereby authorized to enter into a Grant Agreement with Rebuilding Together Central Ohio dba ModCon Living in an amount up to \$270,000.00 to

provide various home repair services to residents in the North Central Community. Program expenses that were incurred prior to the execution of the purchase order, starting August 1, 2023, will be reimbursed.

SECTION 2. That from the unappropriated monies and from all monies estimated to come into said fund from any and all sources and unappropriated for any other purpose during the fiscal year ended December 31, 2023, the sum of \$270,000.00 is appropriated in fund 1000 (General Fund), subfund 100018 (Neighborhoods Initiatives Subfund), Dept-Div 44-01 (Administration), in object class 05 (Other) per the account codes in the attachment to this ordinance.

SECTION 3. That for the purpose as stated in Section 1, the expenditure of \$270,000.00, or so much thereof as may be necessary, is hereby authorized in fund 1000 (General Fund), subfund 100018 (Neighborhood Initiatives Subfund), Dept-Div 44-01 (Administration), in Object Class 05 (Other) per the accounting codes in the attachment to this ordinance.

SECTION 4. Funds are hereby deemed appropriated and expenditures and transfers authorized to carry out the purposes of this ordinance and the City Auditor shall establish such accounting codes as necessary.

SECTION 5. That the City Auditor is authorized to make any accounting changes to revise the funding source for all contracts or contract modifications associated with this ordinance.

SECTION 6. That this ordinance shall take effect and be in force from and after the earliest period allowed by law.

Legislation Number: 2270-2023

Drafting Date: 7/19/2023

Current Status: Passed

Version: 1

Matter Type: Ordinance

Background: The closing of the Scioto Mile Fountain and the construction of the new fountain and park amenities at Bicentennial Park has negatively effected the operation of the Milestone 229 restaurant, located adjacent to the Fountain. The closing of the Fountain and the construction activity have contributed to a significant reduction in the number of guests visiting the restaurant. The following legislation authorizes the Director of the Department of Finance and Management, to execute a Fifth Amendment to Lease Agreement necessary to grant KA Restaurant Concepts LLC a reduction in rent for its Milestone 229 restaurant during the period of this construction project to support the continued operation of the restaurant as part of the amenities of Bicentennial Park..

Fiscal Impact: The City’s rental income will be reduced during the term of the construction that is presently estimated to be completed by June 1, 2024.

Emergency Action: This legislation is presented as emergency in order for the rent reduction to be effective at the earliest date possible to support the continued operation of the restaurant as part of the amenities of Bicentennial Park.

To authorize the Director of the Department of Finance and Management to execute a Fifth Amendment to

Lease Agreement with KA Restaurant Concepts LLC to reduce the rent during the period of the construction project to replace the Scioto Mile Fountain; and to declare an emergency.

WHEREAS, the City is the owner of certain real property, commonly known as Bicentennial Park, containing a restaurant facility located at 229 Civic Center Drive; and

WHEREAS, the City leases the restaurant facility to KA Restaurant Concepts, LLC by that Lease Agreement effective January 1, 2020; and

WHEREAS, the closing of the Scioto Mile Fountain and the construction of the new fountain and park amenities at Bicentennial Park has significantly reduced the number of guests patronizing the restaurant; and

WHEREAS, it is in the best interest of the City to grant a reduction in rent to KA Restaurant Concepts, LLC during the term of the construction project to help offset the reduction in revenue due to the loss of guest traffic; and

WHEREAS, an emergency exists in the usual daily operation of the City in that it is immediately necessary to authorize the Director of Finance and Management to enter into a Fifth Amendment to Lease Agreement by and between the City of Columbus and KA Restaurant Concepts, LLC to immediately provide for a reduction in rent for the term of the Scioto Fountain construction project to support the continued operation of the restaurant as part of the amenities of Bicentennial Park and for the immediate preservation of the public health, peace, property, safety and welfare; **NOW, THEREFORE**;

BE IT ORDAINED BY THE COUNCIL OF THE CITY OF COLUMBUS:

Section 1. That the Director of the Department of Finance be, and hereby is, authorized to execute those documents necessary to enter into a Fifth Amendment to Lease Agreement by and between the City of Columbus and KA Restaurant Concepts, LLC for the restaurant facility located in Bicentennial Park at 229 Civic Center Drive.

Section 2. That the terms and conditions of the Fifth Amendment to Lease Agreement shall be in a form approved by the Department of Law, Division of Real Estate.

Section 3. That for the reasons stated in the preamble hereto, which is hereby made a part hereof, this ordinance is hereby declared to be an emergency measure and shall take effect and be in force from and after its passage and approval by the Mayor, or ten days after passage if the Mayor neither approves nor vetoes the same.

Legislation Number: 2271-2023

Drafting Date: 7/19/2023

Version: 1

Current Status: Passed

Matter Type: Ordinance

BACKGROUND: This ordinance authorizes the Director of Public Utilities to enter into a non-profit service contract with Solar United Neighbors (SUN) to implement a Low to Moderate Income (LMI) Solar Co-Op program.

Solar United Neighbors is a 503(c)(3) nonprofit dedicated to building a clean, equitable energy system with rooftop solar as the cornerstone. SUN utilizes solar co-ops (a bulk-purchasing model) to provide discounted solar rates that help people go solar, jump-start and grow local clean energy markets, bring new constituencies

into the movement, and build support for inclusive clean energy policies. SUN also works closely with community partners to ensure that the economic and social benefits of renewable energy development are invested into the local communities they serve.

SUN's Ohio program, which began in 2016, has launched 38 co-ops to help migrate 611 people to solar, and in the process saving them an estimated \$16.8 million in energy bill savings over their panels' lifespans, while supporting 91 local jobs, and offsetting 172.7 million pounds of carbon emissions. These co-ops included a total of 3 co-ops in Columbus, through which SUN was able to take 67 people solar, facilitating the installations of 532 kW of solar capacity, saving people an estimated \$1 million over their panels' lifespans, and investing \$1.3 million into the local economy. With over 67 solar installations facilitated and 518 participants in the solar info sessions throughout the Columbus Area Solar Co-ops since 2020, SUN has identified an emerging pattern of underserved communities. These are diverse communities that unfortunately have limited means to achieve any degree of energy independence. This can lead directly to higher utility costs and negative health outcomes.

In alignment and support of the Columbus Climate Action Plan, the Sustainable Columbus office is partnering with SUN and IMPACT Community Action to develop a low- to moderate-income (LMI) solar program that applies and adapts SUN's proven co-op model to maximize engagement of low-income communities and maximize the benefits that low-income households receive from solar. This pilot program will help individual LMI homeowners go solar and provide battery backup on their own homes, free of charge. They will also receive the associated financial benefits of solar (30% federal income tax credit, solar renewable energy credits, increased property value and renewable energy property tax exclusion, and solar electricity production). The program will be designed to cover up to 100% of the LMI homeowner's post-energy efficiency electricity usage, helping the homeowner see day-one savings on their monthly electric bill and extending those savings for the lifetime of the solar energy system. Additionally, this program will help determine the barriers to going solar, show demand for rooftop solar in lower-income communities, build trust, educate the community, and address energy burdens. IMPACT Community Action will work directly with SUN to identify Co-Op participants, mostly through their Weatherization program - a federal program that provides energy efficiency upgrades and includes a home audit.

SUN will oversee the installation of seventeen solar systems, including battery backup, for program participants that reflect an income threshold of up to three hundred percent (300%) of the Federal Poverty Level. Year 1 savings under this program are projected to total \$772 per year per household and will collectively reduce the electricity burden by fifty to eighty percent (50-80%). In total, this program is projected to save residents a total of \$656,000.00 and offset 4,796,928 lbs of carbon.

The services included in this agreement cannot be provided by existing city employees because these services are beyond the City's current staffing capacity to provide.

This contract(s) will include program expenses beginning January 1, 2023.
Impact Community Action, FID 462462990, CC#CC018434

FISCAL IMPACT: This ordinance authorizes the expenditure of \$499,500.00 from the Sustainable Columbus Fund, to Solar United Neighbors for implementation of the Solar Co-Op Management Program.

EMERGENCY DESIGNATION: This ordinance is being submitted as an emergency in order to expedite the approval of this contract. The Department is targeting a September date for the unveiling of this program, so we need to get the contract and funding in place as soon as possible.

To authorize the Director of the Department of Public Utilities to enter into a non-profit service contract with Solar United Neighbors for implementation of the Solar Co-op Management Program, a low- to moderate-income (LMI) solar program that increases engagement of low-income communities and maximizes the benefits that low-income households receive from solar; to appropriate \$499,500.00 from the unappropriated balance of the Sustainable Columbus Fund; to authorize the expenditure of \$499,500.00 from the Sustainable Columbus Fund; and to declare an emergency. (\$499,500.00)

WHEREAS, Solar United Neighbors is a 503(c)(3) nonprofit dedicated to building a clean, equitable energy system with rooftop solar as the cornerstone; and

WHEREAS, SUN utilizes solar co-ops (a bulk-purchasing model) to provide discounted solar rates that help people go solar, jump-start and grow local clean energy markets, bring new constituencies into the movement, and build support for inclusive clean energy policies; and

WHEREAS, SUN will develop a low- to moderate-income (LMI) solar program that applies and adapts SUN's proven co-op model to maximize engagement of low-income communities and maximize the benefits that low-income households receive from solar; and

WHEREAS, this program will help individual LMI homeowners go solar and receive battery backup, free of charge and receive the associated financial benefits of solar (30% federal income tax credit, solar renewable energy credits, increased property value and renewable energy property tax exclusion, and solar electricity production); and

WHEREAS, this program will be designed to cover up to 100% of the LMI homeowner's post-energy efficiency electricity usage, helping the homeowner see day-one savings on their monthly electric bill and extending those savings for the lifetime of the solar energy system; and

WHEREAS, this contract is awarded pursuant to provisions relating to non-profit services of City Code Chapter 329.30; and

WHEREAS, an emergency exists in the usual daily operation of the Department of Public Utilities in that it is immediately necessary to authorize the Director to enter into a non-profit service contract with Solar United Neighbors for implementation of the Solar Co-op Management Program, without delay to meet a targeted September date for the unveiling of this program all for the immediate preservation of the public health, peace, property and safety; **NOW, THEREFORE**,

BE IT ORDAINED BY THE COUNCIL OF THE CITY OF COLUMBUS, OHIO:

SECTION 1. That the Director of the Department of Public Utilities is hereby authorized to enter into a non-profit service contract with Solar United Neighbors to implement the Solar Co-op Management Program.

SECTION 2. That from the unappropriated monies and from all monies estimated to come into said fund from any and all sources and unappropriated for any other purpose during the fiscal year ended December 31, 2023, the sum of \$499,500.00 is appropriated in Fund 2260 (Sustainable Columbus Fund), Dept-Div 4550 (Office of the Finance Director), in object class 03 (Contractual Services) per the account codes in the attachment to this ordinance.

SECTION 2. That the expenditure of \$499,500.00, or so much thereof as may be needed in regard to the action authorized in Section 1, is hereby authorized from the Sustainable Columbus Fund 2260 in object class 03 Contractual Services, per the accounting codes in the attachment to this ordinance.

SECTION 3. That the monies in the foregoing Sections shall be paid upon order of the Director of Public Utilities, and that no order shall be drawn or money paid except by voucher, the form of which shall be approved by the City Auditor.

SECTION 4. That the funds necessary to carry out the purpose of this ordinance are hereby deemed appropriated, and the City Auditor shall establish such accounting codes as necessary.

SECTION 5. That the City Auditor is authorized to make any accounting changes to revise the funding source for all contracts or contract modifications associated with this ordinance.

SECTION 6. That this contract is awarded in accordance with the relevant provisions of Columbus City Code Chapter 329.30 relating to awarding not-for-profit service contracts.

SECTION 7. That for the reasons stated in the preamble hereto, which is hereby made a part hereof, this Ordinance is hereby declared to be an emergency measure, and shall take effect and be in force from and after its passage and approval by the Mayor, or ten days after passage if the Mayor neither approves nor vetoes the same.

Legislation Number: 2275-2023

Drafting Date: 7/20/2023

Current Status: Passed

Version: 1

Matter Type: Ordinance

BACKGROUND

The purpose of this ordinance is to amend various sections of the City’s Licensing code pertaining to vehicles for hire and the operations of the Vehicle For Hire and Mobile Food Vending advisory boards. Several updates have been made to this code over the past decade, including revisions to include new modes of transportation such as micro-transit vehicles and pedal wagons. Currently, the City is proposing new minor changes to further update the code.

This ordinance will make the following changes:

- If a licensee is late renewing a license, the Code would now allow the Licensing Section the flexibility to consider extreme hardship as a reason to allow for the renewal, rather than having the licensee register for a new license.
- Alter the requirements for quorum for the Vehicle For Hire and Mobile Food Vending boards by allowing quorum to be half plus one of the current membership of the board, rather than a specific number representing full membership. This would make quorum more frequent, as there are times when not all board seats are filled.
- Change the frequency of Vehicle for Hire Board meetings to quarterly, rather than monthly. Additional meetings are still allowed to be called in situations where the board chair or members call for such.

Overall, these changes will further the City administration's and Council's efforts to update and streamline the Licensing Code and modernize regulations for the City's businesses and residents.

To amend various sections in Chapters 501, 573, and 585 of the Columbus City Codes to allow flexibility in license renewal and alter frequency of regular meetings and quorum for the Vehicle for Hire Board and Mobile Food Vending Advisory Board.

WHEREAS, Title 5 of the Columbus City Codes pertains to business regulation and licensing, and Chapters 501, 573, and 585 pertain to the licensing generally and regulation of vehicles for hire and mobile food vending; and

WHEREAS, several updates have been made to this code over the past decade, including revisions to include new modes of transportation such as micro-transit vehicles and pedal wagons; and

WHEREAS, the City is now proposing minor changes to the code, including additional flexibility to consider license renewals and the quorum and frequency of meetings for the Vehicle for Hire Board and the Mobile Food Vending Advisory Board; and

WHEREAS, these changes will further the City administration's and Council's efforts to update and streamline the Licensing Code and modernize regulations for the City's businesses and residents; **NOW, THEREFORE**,

BE IT ORDAINED BY THE COUNCIL OF THE CITY OF COLUMBUS:

SECTION 1. That sections 501.17, 573.168, 585.09, and 585.14 of the Columbus City Codes are hereby amended as follows:

CHAPTER 501 - LICENSING AND REGULATION GENERALLY

501.17 - Renewal of licenses.

(A) All applications for the renewal of licenses shall be submitted to the section no earlier than sixty (60) days prior to the expiration of the license and shall be upon forms approved by the license manager. License fees shall accompany all applications for renewal.

(B) Failure on the part of a licensee to submit the renewal application at least thirty (30) days prior to the expiration of the license shall be cause for the section to delay the renewal of the license.

(C) Should a licensee submit a renewal application less than (30) days prior to the expiration of a license, or after the lapse of said license, the Licensing Section may allow for renewal if the licensee has been subject to an extreme hardship that rendered them unable to submit the application by the required date. Such hardships may include severe illness or debilitation to themselves or an immediate family member, public health emergencies, political unrest in current place of residence or any place in which they are temporarily located that would render them unable to freely travel domestically or internationally, or similar situation as designated by the Licensing Section. The Director shall promulgate rules and regulations to effectuate this subsection.

CHAPTER 573 - MOBILE FOOD VENDING

573.168 - Meetings; hearings; voting quorums.

(a) The board shall meet at least quarterly, at a time and place designated by the board chair. If a quorum cannot be assembled on the designated meeting date, then the meeting can be postponed until a time that a quorum can be assembled.

(b) All members of the board will be voting members. Eight (8) members of the board, or however so many sitting members of the board constitutes fifty percent (50%) of the total current members plus one, shall constitute a quorum for the transaction of business and a majority vote of those members present at the annual review public meeting shall be necessary to recommend any changes to zones, designated spaces, or courts. The chair shall be counted as a vote if necessary to complete the requirements for a quorum, but otherwise will vote only in the event of a tie vote.

CHAPTER 585 - VEHICLE FOR HIRE BOARD

585.09 - Voting; quorum.

All members of the Board will be voting members. Eight (8) members of the Board, or however so many sitting members of the board constitutes fifty percent (50%) of the total current members plus one, shall constitute a quorum for the transaction of business and a majority vote of those members present shall be necessary to approve or deny any application, or to enact any other item of business. The Director shall be counted as a vote if necessary to complete the requirements for a quorum, but otherwise will vote only in the event of a tie vote.

585.14 - Meetings; hearings.

The Board shall meet at least ~~once every month~~ quarterly, at a time and place designated by the Board chair. The Board shall perform all duties necessary to fulfill requirements assigned to the Board in Chapters 585 through 594. If a quorum cannot be assembled on the designated meeting date, then the meeting can be postponed until a time that a quorum can be assembled.

SECTION 2. That existing sections 501.17, 573.168, 585.09, and 585.14 of the Columbus City Codes are hereby repealed and replaced as provided herein.

SECTION 3. That this ordinance shall take effect and be in force from and after the earliest period allowed by law.

Legislation Number: 2276-2023

Drafting Date: 7/20/2023

Version: 1

Current Status: Passed

Matter Type: Ordinance

BACKGROUND:

This legislation authorizes the City Clerk to enter into a contract with Wentz, McInerney, Peifer & Petroff, LLC for legal services in support of the City's Community Benefits Agreement Advisory Committee and to provide education to city vendors.

The vendor will prepare a guide explaining the purpose of community benefits agreements, how the agreements work, and how the agreements benefit workers, contractors, communities, and the City of Columbus. The firm will use a narrative format and a question-and-answer format to present this information in an accessible manner. In addition to complementing and supporting of the work of the Community Benefits Agreement Advisory Committee, the guide's purpose is congruent with the work of the Office of Diversity and Inclusion (ODI) and may be utilized by that office, as well.

This contract agreement is in compliance with Section 329.24 of the Columbus City Codes. The vendor was selected based on their overwhelming qualifications, given their expertise in the area of labor law and their familiarity with how to build constructive, productive, and effective community benefits agreements.

The total cost associated with this ordinance is \$20,000.00 for the above-described purpose.

FISCAL IMPACT:

The funds for this expenditure are available within the Job Growth subfund.

To authorize the City Clerk to enter into contract with Wentz, McInerney, Peifer & Petroff, LLC for legal and educational services in support of the work of the Community Benefits Agreement Advisory Committee; to authorize an appropriation and expenditure of \$20,000.00 from the Job Growth subfund. (\$20,000.00)

WHEREAS, Columbus City Council passed legislation in 2022 creating the Community Benefits Agreement Advisory Committee and its purpose is to review City development projects and make recommendations regarding community benefits agreements; and

WHEREAS, the Community Benefits Agreement Advisory Committee seeks legal and educational services to create a guide for the use of city departments and city vendors related to the function and purpose of community benefits agreements; and

WHEREAS, the City Clerk selected Wentz, McInerney, Peifer & Petroff, LLC as the most qualified vendor; and

WHEREAS, it is necessary to authorize the City Clerk to enter into a contract with Wentz, McInerney, Peifer & Petroff, LLC to provide legal and education services to the Community Benefits Agreement Advisory Committee; **NOW, THEREFORE**,

BE IT ORDAINED BY THE COUNCIL OF THE CITY OF COLUMBUS:

SECTION 1. That the City Clerk is hereby authorized to enter into a professional services contract with Wentz, McInerney, Peifer & Petroff, LLC, for legal and educational services in an amount of up to \$20,000.00.

SECTION 2. That the City Auditor is hereby authorized and directed to appropriate \$20,000.00 in the Job Growth subfund, fund 1000, subfund 100015, to the City Clerk per the accounting codes in the attachment to this ordinance.

SECTION 3. That the expenditure of \$20,000.00 or so much thereof as may be needed pursuant to the action authorized in SECTION 1 of this ordinance, is hereby authorized in the Job Growth subfund, fund 1000, subfund 100015 per the accounting codes in the attachment to this ordinance.

SECTION 4. That the funds necessary to carry out the purpose of this ordinance are hereby deemed appropriated, and the City Auditor shall establish such accounting codes as necessary.

SECTION 5. That the City Auditor is authorized to make any accounting changes to revise the funding source for all contracts or contract modifications associated with this ordinance.

SECTION 6. That this ordinance shall take effect and be in force from and after the earliest period allowed by law.

Legislation Number: 2277-2023

Drafting Date: 7/20/2023

Current Status: Passed

Version: 1

Matter Type: Ordinance

This ordinance authorizes the City Clerk to enter into a grant agreement with the Columbus Association for the Performing Arts (CAPA), a non profit entity, for the support of the Little Amal event.

CAPA was formed in 1969 to save the historic Ohio Theatre (Columbus) from the wrecking ball. After the theatre was saved, CAPA renovated the magnificent 1928 movie palace to its original glory. It was then that CAPA became the leaders in theatre rehabilitation and downtown redevelopment.

Columbus, Ohio has a special opportunity to welcome Little Amal to our community on Friday, September 22, 2023. In partnership with the City of Columbus, Columbus City Council, US Together, and Welcoming City, CAPA is taking the lead on the planning and execution of the event with Little Amal, the 12 foot puppet of a 10 year old Syrian refugee child at the heart of The Walk. She has become a global symbol of human rights, especially those of refugees. Between September and November 2023, Amal will journey 6,000 miles across the United States. 35 towns and cities from Boston to San Diego and 1,000+ artists and arts organizations will create 100+ events to welcome her.

Emergency action is necessary to provide upfront funding to pay for services in anticipation of the September 22, 2023 event.

Fiscal Impact: Funding is available within the Neighborhood Initiatives subfund.

To authorize the City Clerk to enter into a grant agreement with the Columbus Association for the Performing Arts (CAPA) in support of the Little Amal event; to authorize an appropriation and expenditure within the Neighborhood Initiatives subfund; and to declare an emergency. (\$10,000.00)

WHEREAS, CAPA was formed in 1969 to save the historic Ohio Theatre (Columbus) from the wrecking ball; and

WHEREAS, Little Amal has become an international symbol of compassion and of human rights carrying a message of hope for displaced people everywhere, especially children who have been separated from their families; and

WHEREAS, she has visited 14 countries including Turkey, Greece, Italy, France, the UK, the United States, Canada, Poland and Ukraine; and

WHEREAS, an emergency exists in the usual daily operation of the Clerk's Office in that it is immediately necessary to authorize the City Clerk to enter into a grant agreement providing upfront funding to the Columbus Association for the Performing Arts for the support of the Little Amal event in time to plan the September 22, 2023 event thereby preserving the public health, peace, property, safety and welfare; **NOW, THEREFORE**,

BE IT ORDAINED BY THE COUNCIL OF THE CITY OF COLUMBUS:

SECTION 1. That the City Clerk is authorized to enter into a grant agreement with the not-for-profit Columbus Association for the Performing Arts to provide upfront funding to in support of their Little Amal event.

SECTION 2. That the appropriation and expenditure of \$10,000.00, or so much thereof as may be needed pursuant to the action authorized in SECTION 1, is authorized in the Neighborhood Initiatives subfund, fund 1000, subfund 100018, per the accounting codes in the attachment to this ordinance.

SECTION 3. That the funds necessary to carry out the purpose of this ordinance are deemed appropriated, and the City Auditor shall establish such accounting codes as necessary.

SECTION 4. That the City Auditor is authorized to make any accounting changes to revise the funding source for all contracts or contract modifications associated with this ordinance.

SECTION 5. That for the reason stated in the preamble hereto, which is hereby made a part hereof, this ordinance is hereby declared to be an emergency measure and shall take effect and be in force from and after its passage and approval by the Mayor, or ten days after passage if the Mayor neither approves nor vetoes the same.

Legislation Number: 2278-2023

Drafting Date: 7/20/2023

Current Status: Passed

Version: 1

Matter Type: Ordinance

This ordinance authorizes the City Clerk to enter into a grant agreement with Kaleidoscope Youth Center, a non profit entity, for the support of their Wellness Initiative and Emergency Housing programs.

Kaleidoscope Youth Center (KYC) is the largest and longest standing organization serving LGBTQIA+ youth in the state of Ohio. Since 1994, KYC has been the leader and expert in meeting the needs of and supporting LGBTQIA+ young people in the central Ohio community.

The KYC Community Wellness Initiative is an expansion of KYC's current programming with an intersectional focus on the emerging mental health and wellness needs of LGBTQIA+ youth and young adults. This initiative works to implement sustainable community based wellness programs that improve the lives of adolescents; identify health conditions and environmental factors that are associated with barriers to wellness, and aid in improving the social determinants of health and wellness as it relates to LGBTQIA+ youth and young adults. Clinical approaches will include trauma informed, wrap-around services to support young people in meeting their basic needs and building a strong sense of self and self-esteem through affirmation and empowerment, and holistic health and wellness activities.

The KYC Emergency Housing Program serves and supports homeless and housing insecure/vulnerable young adults ages 18-24 through the lenses of intersectionality and trauma informed/healing engaged care. The vision is to keep our young people off of the streets, and to decrease and disrupt the potential and/or subsequent crises that often arise when youth are without a predictable and consistent safe place to stay. Through no less than a 30 day supported stay at a local extended stay facility or hotel, youth will have the opportunity to experience a safer and supportive housing environment. Programming is low barrier to prioritize prevention through early engagement and linkage to resources and community support. Each young person utilizing services will be provided a case manager to assist them in developing and implementing a case plan, with the ultimate goal being to move participants from supportive housing into a safe, stable, and sustainable independent housing experience.

Emergency action is necessary to ensure funding is available immediately to provide assistance to the mental health and housing needs of LGBTQIA+ youth and young adults.

Fiscal Impact: Funding is available within the Neighborhood Initiatives subfund.

To authorize the City Clerk to enter into a grant agreement with Kaleidoscope Youth Center in support of their Wellness Initiative and Emergency Housing programs; to authorize an appropriation and expenditure within the Neighborhood Initiatives subfund; and to declare an emergency. (\$250,000.00)

WHEREAS, since 1994, KYC has been the leader and expert in meeting the needs of and supporting LGBTQIA+ young people in the central Ohio community; and

WHEREAS, The KYC Community Wellness Initiative is an expansion of KYC's current programming with an intersectional focus on the emerging mental health and wellness needs of LGBTQIA+ youth and young adults; and

WHEREAS, programming from the KYC Community Wellness Initiative is provided by a wellness practitioner/team, supportive community programming, and resources to collaborate with community partners and providers; and

WHEREAS, it is counter to the public good to allow financial barriers to prevent residents' access to personal identification documents, which are themselves vital for securing economic prosperity; and

WHEREAS, the KYC Emergency Housing Program serves and supports homeless and housing insecure/vulnerable young adults ages 18-24 through the lenses of intersectionality and trauma informed/healing engaged care; and

WHEREAS, through no less than a 30 day supported stay at a local extended stay facility or hotel, youth will have the opportunity to experience a safer and supportive housing environment. Programming is low barrier to prioritize prevention through early engagement and linkage to resources and community support; and

WHEREAS, an emergency exists in the usual daily operation of the City Clerk's Office in that it is immediately necessary to authorize the City Clerk to enter into a grant agreement with Kaleidoscope Youth Center for the support of their of their Wellness Initiative and Emergency Housing programs in time to immediately provide assistance to the mental health and housing needs of LGBTQIA+ youth and young adults thereby preserving the public health, peace, property, safety and welfare; **NOW, THEREFORE**,

BE IT ORDAINED BY THE COUNCIL OF THE CITY OF COLUMBUS:

SECTION 1. That the City Clerk is authorized to enter into a grant agreement with the not-for-profit Kaleidoscope Youth Center in support of their Wellness Initiative and Emergency Housing programs.

SECTION 2. That the appropriation and expenditure of \$250,000.00, or so much thereof as may be needed pursuant to the action authorized in SECTION 1, is authorized in the Neighborhood Initiatives subfund, fund 1000, subfund 100018, per the accounting codes in the attachment to this ordinance.

SECTION 3. That the funds necessary to carry out the purpose of this ordinance are deemed appropriated, and the City Auditor shall establish such accounting codes as necessary.

SECTION 4. That the City Auditor is authorized to make any accounting changes to revise the funding source for all contracts or contract modifications associated with this ordinance.

SECTION 5. That for the reason stated in the preamble hereto, which is hereby made a part hereof, this ordinance is hereby declared to be an emergency measure and shall take effect and be in force from and after its passage and approval by the Mayor, or ten days after passage if the Mayor neither approves nor vetoes the same.

Legislation Number: 2279-2023

Drafting Date: 7/20/2023

Version: 1

Current Status: Passed

Matter Type: Ordinance

This ordinance authorizes the City Clerk to enter into a grant agreement with the Columbus Kappa Foundation, a non profit entity, for the support of their Opiate Community Connectors Program.

The Columbus Kappa Foundation has been directly working with populations vulnerable to drug use and overdose since its creation in 1994. New research shows racial disparities in opioid overdose rates, with the rate of deaths among Black people growing faster than in other groups. The researchers are calling for expanding access to drug treatment and to education on how to prevent overdoses using the antidote drug, naloxone. The Opiate Community Connectors Program is a network of supporters who intervene and help find treatment for people with substance use disorder. The Opiate Community Connectors Program partners with churches and other faith institutions, schools, shelters, halfway houses, and other community infrastructures with the aim of strengthening naloxone distribution efforts in areas most affected by overdose numbers.

These partnerships will result in trainings conducted by The Opiate Community Connectors Program of lay distribution volunteers to engage with their neighborhoods to make naloxone access available as well as acceptable. Additionally, The Opiate Community Connectors Program will develop and implement a drug use presentation to be presented at specific organizations located in at-risk neighborhoods. This presentation will include a Narcan kit demonstration, educating the community on harm reduction efforts within the service area.

Emergency action is necessary to ensure funding is available immediately for residents who are suffering from opiate addiction.

Fiscal Impact: Funding is available within the Neighborhood Initiatives subfund.

To authorize the City Clerk to enter into a grant agreement with the Columbus Kappa Foundation in support of their Opiate Community Connectors Program; to authorize an appropriation and expenditure within the Neighborhood Initiatives subfund; and to declare an emergency. (\$25,000.00)

WHEREAS, the Columbus Kappa Foundation has been directly working with populations vulnerable to drug use and overdose since its creation in 1994; and

WHEREAS, new research shows racial disparities in opioid overdose rates, with the rate of deaths among Black people growing faster than in other groups; and

WHEREAS, the Columbus Kappa Foundation plans on further developing and implementing a drug use presentation to be presented at specific organizations located in at-risk neighborhoods to include a Narcan kit demonstration, educating the community on harm reduction efforts within the service area; and

WHEREAS, the Opiate Community Connectors Program is a network of supporters who intervene and help find treatment for people with substance use disorder; and

WHEREAS, an emergency exists in the usual daily operation of the City Clerk's Office in that it is immediately necessary to authorize the City Clerk to enter into a grant agreement with The Columbus Kappa Foundation for the support of their Opiate Community Connectors Program to allow for immediate assistance to residents suffering from opiate addiction thereby preserving the public health, peace, property, safety and welfare; **NOW, THEREFORE**,

BE IT ORDAINED BY THE COUNCIL OF THE CITY OF COLUMBUS:

SECTION 1. That the City Clerk is authorized to enter into a grant agreement with the not-for-profit Community Development for All People in support of their Opiate Community Connectors Program.

SECTION 2. That the appropriation and expenditure of \$25,000.00, or so much thereof as may be needed pursuant to the action authorized in SECTION 1, is authorized in the Neighborhood Initiatives subfund, fund 1000, subfund 100018, per the accounting codes in the attachment to this ordinance.

SECTION 3. That the funds necessary to carry out the purpose of this ordinance are deemed appropriated, and the City Auditor shall establish such accounting codes as necessary.

SECTION 4. That the City Auditor is authorized to make any accounting changes to revise the funding source for all contracts or contract modifications associated with this ordinance.

SECTION 5. That for the reason stated in the preamble hereto, which is hereby made a part hereof, this ordinance is hereby declared to be an emergency measure and shall take effect and be in force from and after its passage and approval by the Mayor, or ten days after passage if the Mayor neither approves nor vetoes the same.

Legislation Number: 2280-2023

Drafting Date: 7/21/2023

Version: 1

Current Status: Passed

Matter Type: Ordinance

BACKGROUND

The purpose of this ordinance is to appropriate \$106,000.00 within the Public Safety Initiative subfund to the Department of Public Safety, so that the department can provide funding for forgivable home loans for the Safety Forces Residential Incentive Program (SFRIP).

The SFRIP is a pilot program that began in 2020 to offer up to \$10,000 in the form of a secondary home loan to police officers and firefighters who have successfully completed their probationary periods and are purchasing a home within the City of Columbus corporate boundaries. The officer or firefighter must then live in that home for five years for the loan to be completely forgivable. The pilot is administered by CME Federal Credit Union and the loan dollars disbursed by City payroll. This funding will allow for a continuation of the program.

Over the past several years, the City has been engaged in efforts to further diversify the safety forces in Columbus and ensure that those ranks reflect the communities in which they serve. The extension of this pilot program will continue to serve as an incentive for those charged with the safety of City residents to live in some of the same neighborhoods that they work.

EMERGENCY DESIGNATION: Emergency action is requested to ensure that the Department of Public Safety has the ability to provide the benefit as soon as practicable to protect the health, safety, and welfare of the residents of Columbus.

FISCAL IMPACT: Total appropriation is \$106,000.00 and is available in the 2023 budget within the Public Safety Initiative subfund, Fund 1000-100016.

To appropriate \$106,000.00 within the Public Safety Initiative subfund to the Department of Public Safety to provide forgivable home loans for the Safety Forces Residential Incentive Program; and to declare an emergency. (\$106,000.00)

WHEREAS, the City has been engaged in efforts to further diversify the safety forces in Columbus and ensure that those ranks reflect the communities in which they serve; and,

WHEREAS, continuing to promote City residency will serve to encourage police officers and firefighters to take the opportunity to live in some of the same neighborhoods in which they work; and,

WHEREAS, CME Federal Credit Union has been previously involved with this pilot, as well as in other benefits offered to Columbus uniformed personnel; and,

WHEREAS, \$106,000.00 is available in the Public Safety Initiative Fund for appropriation to provide for this need; and,

WHEREAS, an emergency exists in the usual daily operation of the Department of Public Safety, in that it is necessary to ensure that the Department has the ability to provide funding for the benefit as soon as practicable and prior to the City Council summer recess for the immediate preservation of the public health, peace,

property, safety, and welfare; **NOW, THEREFORE:**

BE IT ORDAINED BY THE COUNCIL OF THE CITY OF COLUMBUS:

SECTION 1: That \$106,000.00 is hereby appropriated to the Department of Public Safety to provide forgivable home loans for the Safety Forces Residential Incentive Program per the accounting codes in the attachment to this ordinance.

SECTION 2. That the City Auditor is hereby authorized and directed to appropriate \$106,000.00 in the Public Safety Initiatives sub-fund, fund 1000, sub-fund 100016, to the Department of Public Safety, per the accounting codes in the attachment to this ordinance.

SECTION 3: That the funds necessary to carry out the purpose of this ordinance are hereby deemed appropriated, and the City Auditor shall establish such accounting codes as necessary.

SECTION 4: That for reasons stated in the preamble hereto, which is hereby made a part hereof, this ordinance is declared to be an emergency measure and shall take effect and be in force from and after its passage and approval by the Mayor, or ten days after passage if the Mayor neither approves nor vetoes the same.

Legislation Number: 2283-2023

Drafting Date: 7/21/2023

Current Status: Passed

Version: 1

Matter Type: Ordinance

Background: This ordinance authorizes the Finance and Management Director to acquire real property, consisting of approximately 6.5Acres +/-, commonly known as 4285 Groves Road, Columbus, Ohio 43232, and further identified as Franklin County Tax Parcel No. 010-201154. This site will serve primarily to support the needs of Department’s Facilities Management Division and other departmental needs and secondarily, will potentially support a unit of the Columbus Division of Police.

This legislation authorizes the Director of Finance and Management to execute those documents necessary to purchase the real property from Buckeye State 3530 LLC, a Delaware limited liability company, 390 E. Parkcenter Blvd., Ste. 200, Boise, Idaho 83706 and authorizes the amendment of 2022 Capital Improvements Budget appropriation and expenditure of funds in Fund 7733, the Construction Management Capital Improvements Fund in an amount up to Two Million Six Hundred Fifty Thousand Dollars (\$2,650,000.00) for payment of all costs associated with the acquisition, securing of the real property and closing costs. The legislation is presented as an emergency measure

Fiscal Impact: Funding of \$2,650,000.00 is budgeted and available within Fund 7733, the Construction Management Capital Improvements Fund to pay the costs associated with the acquisition and closing. A transfer of funding between projects will be necessary.

Emergency Justification: Emergency action is requested to allow for the immediate execution of the purchase agreement by the City so that the acquisition can proceed without delay in agreement with the closing transaction deadlines and other terms of the purchase agreement.

To authorize the Director of Finance and Management to execute those documents necessary to acquire fee simple title and lesser interests to real property identified as Franklin County Tax Parcel 010-201154 located at 4285 Groves Road; to amend the 2023 Capital Improvement Budget; to authorize the transfer of cash and appropriation within the Construction Management Capital Improvements Fund, Fund 7733; to authorize the expenditure of up to \$2,650,000.00 from the Construction Management Capital Improvements Fund, Fund No. 7733; and to declare an emergency. (\$2,650,000.00).

WHEREAS, the City of Columbus Department of Finance and Management desires to enter into a purchase contract between the City and Buckeye State 3530 LLC, a Delaware limited liability company, 390 E. Parkcenter Blvd., Ste. 200, Boise, ID 83706 for the purchase of approximately 6.5 acres +/-, commonly known as 4285 Groves Road, Columbus, Ohio 43232; and

WHEREAS, the 6.5 acre site to be acquired will support the needs of Department's Facilities Management Division and other departmental needs and secondarily, will potentially support a unit of the Columbus Division of Police and is ideally located adjacent to City's Fleet Management Facility; and

WHEREAS, it is necessary to amend the 2023 Capital Improvements Budget for the purpose of providing sufficient spending authority for the acquisition of the property; and

WHEREAS, it is necessary to authorize the transfer of cash and appropriation within the Construction Management Capital Improvements Fund; and

WHEREAS, an emergency exists in the usual daily operation of the Department of Finance and Management in that it is immediately necessary to authorize the Director of Finance and Management to execute those documents necessary for the acquisition of that real property identified as Franklin County Tax Parcel 010-201154, commonly known as 4285 Groves Road, Columbus, Ohio 43232, from Buckeye State 3530 LLC, a Delaware limited liability company, at the earliest feasible date in agreement with the closing transaction deadlines and other terms of the purchase agreement thereby providing for the immediate preservation of the public health, peace, property, welfare; and **now therefore**,

BE IT ORDAINED BY THE COUNCIL OF THE CITY OF COLUMBUS:

SECTION 1. That the Director of Finance and Management, is authorized to execute those documents by and between the City and Buckeye State 3530 LLC, a Delaware limited liability company for the purchase of approximately 6.5 acres, more or less, of real property identified as Franklin County Tax Parcel 010-201154 located at 4285 Groves Road.

SECTION 2. That the 2023 Capital Improvements Budget adopted with ordinance 1711-2023 is hereby amended as per the attachment to this ordinance.

SECTION 3. That the transfer of cash and appropriation of \$2,000,000.00 or so much thereof as may be needed, is hereby authorized within the Construction Management Capital Improvements Fund per the account codes in the attachment to this ordinance.

SECTION 4. That the expenditure of Two Million Six Hundred Fifty Thousand Dollars and 00/100 Dollars (\$2,650,000.00), or so much thereof as may be necessary, be and is hereby authorized in Fund 7733 per the accounting codes in the funding attachment to this ordinance.

SECTION 5. That the City Auditor is authorized to make any accounting changes to revise the funding source for all contracts or contract modifications associated with this ordinance.

SECTION 6. That the City Auditor is authorized to transfer the unencumbered balance in a project account to the unallocated balance account of the same fund upon receipt of certification by the Director of the Department administering said project that the project has been completed and the monies are no longer required for said project.

SECTION 7. That the funds necessary to carry out the purpose of this ordinance are hereby deemed appropriated, and the City Auditor shall establish such accounting codes as necessary.

SECTION 8. That for the reasons stated in the preamble hereto, which is hereby made a part hereof, this Ordinance is hereby declared to be an emergency measure and shall take effect and be in force from and after its passage and approval by the Mayor, or ten days after passage if the Mayor neither approves nor vetoes the same.

Legislation Number: 2284-2023

Drafting Date: 7/21/2023

Current Status: Passed

Version: 1

Matter Type: Ordinance

BACKGROUND:

This legislation authorizes the City Clerk to enter into a grant agreement with People Like Me Project Inc to operate the Outlet Basketball program serving Franklin County youth.

People Like Me will provide a transformative community-based learning initiative to local youth, ages 10 to 16, through The Outlet Basketball program. Through meticulously designed curriculum and expert coaching staff, People Like Me aims to provide participants with an immerse experience that not only enhances their basketball skills but cultivates valuable life skills such as teamwork, discipline, resilience, and leadership.

The program begins on August 28th, 2023 and runs through February 26th, 2024. This agreement will support facility costs, a subscription to a registration platform, and coach stipends in advance of the start of the program.

The total cost associated with this ordinance is \$5,500.00 for the above-described purpose.

FISCAL IMPACT:

The funds for this expenditure are available within the Neighborhood Initiatives subfund.

EMERGENCY:

Emergency designation is being requested to expedite authorization in order to provide support as soon as possible to secure facilities for programming, set up a registration process for participates, and secure coaching staff in advance of the program start date of August 28th.

To authorize the City Clerk to enter into a grant agreement with People Like Me Project, Inc. for youth community engagement programming; to authorize an appropriation and expenditure of \$5,500.00 from the Neighborhood Initiatives subfund; and to declare an emergency (\$5,500.00).

WHEREAS, Columbus City Council seeks to support safe and healthy neighborhoods, including through youth engagement opportunities such as sports and life skills opportunities; and

WHEREAS, People Like Me will provide a youth basketball and life skills programming opportunity for local youth, ages 10 to 16; and

WHEREAS, an emergency exists in the usual daily operation of the Clerk's Office in that it is immediately necessary to authorize the City Clerk to enter into a grant agreement with People Like Me Project, Inc. in order to secure necessary funds to administer The Outlet Basketball Program starting on August 28th; **NOW,**

THEREFORE,

BE IT ORDAINED BY THE COUNCIL OF THE CITY OF COLUMBUS:

SECTION 1. That the City Clerk is hereby authorized to enter into a grant agreement with People Like Me Project, Inc. to administer the Outlet Basketball program to provide youth sports engagement for Columbus youth ages 10 to 16.

SECTION 2. That the City Auditor is hereby authorized and directed to appropriate \$5,500.00 in the Neighborhood Initiatives subfund, fund 1000, subfund 100018, to the City Clerk per the accounting codes in the attachment to this ordinance.

SECTION 3. That the expenditure of \$5,500.00 or so much thereof as may be needed pursuant to the action authorized in SECTION 1 of this ordinance, is hereby authorized in the Neighborhood Initiatives subfund, fund 1000, subfund 100018 per the accounting codes in the attachment to this ordinance.

SECTION 4. That the funds necessary to carry out the purpose of this ordinance are hereby deemed appropriated, and the City Auditor shall establish such accounting codes as necessary.

SECTION 5. That the City Auditor is authorized to make any accounting changes to revise the funding source for all contracts or contract modifications associated with this ordinance.

SECTION 6. That for the reasons stated in the preamble hereto, which is hereby made a part hereof, this ordinance is hereby declared to be an emergency measure and shall take effect and be in force from and after its passage and approval by the Mayor, or ten (10) days after passage if the Mayor neither approves nor vetoes the same.

Legislation Number: 2286-2023

Drafting Date: 7/24/2023

Version: 1

Current Status: Passed

Matter Type: Ordinance

This ordinance authorizes the Director of Finance and Management to enter into a grant agreement with End the Violence in support of their community violence intervention program.

End the Violence (ETV) is a crisis management and intervention organization that leverages the widely-recognized “credible messengers” approach to stemming violence before it escalates. ETV utilizes a team of community-based interventionists to provide alternative activities for residents who may otherwise engage in criminal and/or violent activity. ETV’s goals are to engage underserved hotspots in a culturally-informed manner, provide close-to-home work opportunities with pay, and to expose residents to opportunities for sustainable employment paying a living wage. In addition, ETV interventionists provide continuity and connections to supportive services to residents needing additional ongoing assistance.

This funding is expected to support community interventionists working throughout Columbus neighborhoods, as well as the funding necessary to support the activities that engage youths and residents most at-risk of engaging in violence.

FISCAL IMPACT: The funding of \$500,000.00 is available within the Public Safety Initiatives subfund.

EMERGENCY ACTION is requested in order to immediately address neighborhood violence in the remainder of the summer in Columbus.

To authorize the Director of Finance and Management to enter into a grant agreement with End the Violence in support of community violence intervention; to authorize an appropriation and expenditure of \$500,000.00 within the Public Safety Initiatives subfund; and to declare an emergency. (\$500,000.00)

WHEREAS, End the Violence (ETV) is a crisis management and intervention program that leverages the widely-recognized “credible messengers” approach to stemming violence before it escalates; and

WHEREAS, ETV utilizes a team of community-based interventionists to provide alternative activities for residents who may otherwise engage in criminal and/or violence activity; and

WHEREAS, this funding will support community interventionists, as well as the activities that ETV provides as alternatives to engaging in violent behavior; and

WHEREAS, an emergency exists in the daily operations of the Department of Finance and Management such that it is necessary to authorize the Director to enter into a grant agreement with End the Violence in order to immediately address neighborhood violence in Columbus; **NOW, THEREFORE**,

BE IT ORDAINED BY THE COUNCIL OF THE CITY OF COLUMBUS:

SECTION 1. That the Director of the Department of Finance and Management is hereby authorized and directed to enter into a grant agreement with End the Violence in support of community violence intervention.

SECTION 2. That the Auditor is hereby authorized and directed to appropriate \$500,000.00 to the Department of Finance and Management within the Public Safety Initiatives subfund, per the accounting codes in the attachment to this ordinance.

SECTION 3. That per the action authorized in Section 1 of this ordinance, the expenditure and advanced payment of \$500,000.00, or so much thereof as may be needed, is hereby authorized per the accounting codes in the attachment to this ordinance.

SECTION 4. That the funds necessary to carry out the purpose of this ordinance are hereby deemed appropriated, and the City Auditor shall establish such accounting codes as necessary.

SECTION 5. That the City Auditor is authorized to make any accounting changes to revise the funding source for all contracts or contract modifications associated with this ordinance.

SECTION 6. That for the reasons stated in the preamble hereto, which is hereby made a part hereof, this ordinance is hereby declared to be an emergency measure and shall take effect and be in force from and after its passage and approval by the Mayor, or ten days after passage if the Mayor neither approves nor vetoes the same.

Legislation Number: 2290-2023

Drafting Date: 7/24/2023

Current Status: Passed

Version: 1

Matter Type: Ordinance

This ordinance authorizes the City Clerk to enter into a grant agreement with the New American Community Information Center, a non-profit organization, in support of the New Americans Book Fair.

The New Americans Magazine and the New American Community Information Center, in conjunction with the Dublin branch of the Columbus Metropolitan Library, Dublin, Ohio are hosting the second edition of the New Americans Book Fair on Saturday, September 23, 2023.

The New Americans Book Fair is an annual event that provides a platform for New American, immigrant, and refugee authors, writers, aspiring authors, artists, film producers, printers, publishers, investors and related individuals and organizations to exhibit and promote their works in Columbus, Ohio. New Americans Book Fair is a platform for participants to network and promote their works of art, books, skills and expertise relating to arts in an expanded environment that creates opportunities for growth and development.

Fiscal Impact: The funding of \$10,000.00 is available within the Neighborhood Initiatives subfund.

Emergency action is requested in order to provide the organization with resources in advance of the September event.

To authorize the City Clerk to enter into a grant agreement with the New American Community Information Center in support of the New Americans Book Fair; to authorize an appropriation and expenditure within the Neighborhood Initiatives subfund; and to declare an emergency. (\$10,000.00)

WHEREAS, the New Americans Magazine and the New American Community Information Center are hosting the second edition of the New Americans Book Fair on Saturday, September 23, 2023; and

WHEREAS, the New Americans Book Fair is an annual event that provides a platform for New American, immigrant, and refugee authors, writers, aspiring authors, artists, film producers, printers, publishers, investors and related individuals and organizations to exhibit and promote their works; and

WHEREAS, New Americans Book Fair is a platform for participants to network and promote their works of art, books, skills and expertise relating to arts in an expanded environment that creates opportunities for growth and development; and

WHEREAS, an emergency exists in the usual daily operations of the City Clerk in that it is immediately necessary to authorize a grant agreement to provide the organization with resources in advance of the upcoming September event; **NOW, THEREFORE**,

BE IT ORDAINED BY THE COUNCIL OF THE CITY OF COLUMBUS:

SECTION 1. That the City Clerk is hereby authorized to enter into a grant agreement with the New American Community Information Center in support of the New Americans Book Fair.

SECTION 2. That the Auditor is hereby authorized and directed to appropriate \$10,000.00 within the Neighborhood Initiatives subfund, fund 1000, subfund 100018, to Columbus City Council per the accounting codes in the attachment to this ordinance.

SECTION 3. That per the action authorized in Section 1 of this ordinance, the expenditure of \$10,000.00, or so much thereof as may be needed, is hereby authorized per the accounting codes in the attachment to this ordinance.

SECTION 4. That the funds necessary to carry out the purpose of this ordinance are hereby deemed appropriated, and the City Auditor shall establish such accounting codes as necessary.

SECTION 5. That the City Auditor is authorized to make any accounting changes to revise the funding source for all contracts or contract modifications associated with this ordinance.

SECTION 6. That for the reasons stated in the preamble hereto, which is hereby made a part hereof, this ordinance is hereby declared to be an emergency measure and shall take effect and be in force from and after its passage and approval by the Mayor, or ten days after passage if the Mayor neither approves nor vetoes the same.

Legislation Number: 2291-2023

Drafting Date: 7/24/2023

Current Status: Passed

Version: 1

Matter Type: Ordinance

This ordinance authorizes the City Clerk to enter into a grant agreement with the Garden Club Project.

The Garden Club Project (TGCP) was founded by teen-preneur Te'Lario Watkins II of Tiger Mushroom Farms. The mission of TGCP is to help end hunger and encourage kids to eat healthier. TGCP has encouraged youth to grow food by donating over 300 seed kits to kids at farmers markets & schools. Te'lario also started a small garden for a local elementary school, from which over 300 pounds of food has been donated to families in need. Te'Lario is expanding his urban farm by adding a high tunnel to extend the harvest season. Te'Lario will teach 30 students from the COSI Platform Program how to grow mushrooms and produce this summer. He will introduce students to careers in agribusiness.

Fiscal Impact: The funding of \$10,000.00 is available within the Neighborhood Initiatives subfund.

To authorize the City Clerk to enter into a grant agreement with the Garden Club Project; and to authorize an appropriation and expenditure within the Neighborhood Initiatives subfund. (\$10,000.00)

WHEREAS, the Garden Club Project (TGCP) was founded by teen-preneur Te'Lario Watkins II of Tiger Mushroom Farms; and

WHEREAS, the mission of TGCP is to help end hunger and encourage kids to eat healthier; and

WHEREAS, TGCP is expanding its urban farm by adding a high tunnel to extend the harvest season; and

WHEREAS, TGCP will teach 30 students from the COSI Platform Program how to grow mushrooms and produce; **NOW, THEREFORE**,

BE IT ORDAINED BY THE COUNCIL OF THE CITY OF COLUMBUS:

SECTION 1. That the City Clerk is hereby authorized to enter into a grant agreement with the Garden Club Project.

SECTION 2. That the Auditor is hereby authorized and directed to appropriate \$10,000.00 within the Neighborhood Initiatives subfund, fund 1000, subfund 100018, to Columbus City Council per the accounting codes in the attachment to this ordinance.

SECTION 3. That per the action authorized in Section 1 of this ordinance, the expenditure of \$10,000.00, or so much thereof as may be needed, is hereby authorized per the accounting codes in the attachment to this ordinance.

SECTION 4. That the funds necessary to carry out the purpose of this ordinance are hereby deemed appropriated, and the City Auditor shall establish such accounting codes as necessary.

SECTION 5. That the City Auditor is authorized to make any accounting changes to revise the funding source for all contracts or contract modifications associated with this ordinance.

SECTION 6. That this ordinance shall take effect at the earliest date allowable by law.

Legislation Number: 2294-2023

Drafting Date: 7/25/2023

Version: 1

Current Status: Passed

Matter Type: Ordinance

BACKGROUND: This legislation authorizes an amendment to Ordinance No. 1710-2023, passed by Columbus City Council on July 10, 2023, to allow for a correction of the name of two (2) of the organizations in Exhibit A.

Ordinance No. 1710-2023, passed by Columbus City Council on July 10, 2023, authorized the Director of the Department of Recreation and Parks to enter into 32 service contracts for the provision of home-delivered meals, adult day care, transportation, home repair, and legal services for the period July 1, 2023 through September 30, 2024.

Exhibit A included an organization with the name “Avalon Adult Day Service Corp. dba: Complete Adult Day Service Corp”. It was recently discovered that this is the trade name of the organization, not the legal name. The legal name, as registered with the Ohio Secretary of State, is “Complete Adult Day Service”.

Exhibit A also included an organization with the name “Lancaster-Fairfield Community Action Program Commission” It was recently discovered that this is the trade name of the organization, not the legal name. The legal name, as registered with the Ohio Secretary of State, is “Community Action Program Commission of the Lancaster Fairfield County Area Inc”.

All other information in Exhibit A remains the same. Emergency action is requested in order to reimburse for approved expenses incurred since July 1, 2023, to prevent these organizations from experiencing financial hardship.

To amend Ordinance No. 1710-2023, passed by Columbus City Council on July 10, 2023, to allow for a correction of the name of two (2) of the organizations in Exhibit A, from “Avalon Adult Day Service Corp. dba: Complete Adult Day Service Corp” to “Complete Adult Day Service”, “Lancaster-Fairfield Community Action Program Commission” to “Community Action Program Commission of the Lancaster Fairfield County Area Inc”; and to declare an emergency.

WHEREAS, Ordinance No. 1710-2023, passed by Columbus City Council on July 10, 2023, authorized the Director of the Department of Recreation and Parks to enter into 32 service contracts for the provision of home-delivered meals, adult day care, transportation, home repair, and legal services for the period July 1, 2023 through September 30, 2024.

WHEREAS, Exhibit A of Ordinance No. 1710-2023 included an organization with the name “Avalon Adult Day Service Corp. dba: Complete Adult Day Service Corp”; and

WHEREAS, it was recently discovered that this is the trade name of the organization, not the legal name. The legal name, as registered with the Ohio Secretary of State, is “Complete Adult Day Service”; and

WHEREAS, Exhibit A of Ordinance No. 1710-2023 included an organization with the name “Lancaster-Fairfield Community Action Program Commission” ;and

WHEREAS, it was recently discovered that this is the trade name of the organization, not the legal name. The legal name, as registered with the Ohio Secretary of State, is "Community Action Program Commission of the Lancaster Fairfield County Area Inc"; and

WHEREAS, the Director of the Department of Recreation and Parks requests that Ordinance No. 1710-2023 be amended in order to correct the organization names: and

WHEREAS, an emergency exists in the usual daily operation of the Department of Recreation and Parks in that it is immediately necessary to amend Ordinance 1710-2023, passed by Columbus City Council on July 10, 2023, in order to reimburse for approved expenses incurred since July 1, 2023, to prevent the organizations from experiencing financial hardship; now, therefore,

BE IT ORDAINED BY THE COUNCIL OF THE CITY OF COLUMBUS:

SECTION 1. That Exhibit A of Ordinance No. 1710-2023, passed by Columbus City Council on July 10, 2023, be amended to read as follows, with deletion stricken and new language in bold: Avalon Adult Day Service Corp. dba: Complete Adult Day Service Corp, and Lancaster-Fairfield Community Action Program Commission to Complete Adult Day Service, and Community Action Program Commission of the Lancaster Fairfield County Area Inc.

SECTION 2. That for the reasons stated in the preamble hereto, which is hereby made a part hereof, this ordinance is hereby declared to be an emergency measure which shall take effect and be in force from and after its passage and approval by the Mayor, or ten days after passage if the Mayor neither approves nor vetoes it.

Legislation Number: 2297-2023

Drafting Date: 7/25/2023

Current Status: Passed

In December 2021, the Columbus District Map was adopted by Columbus City Council. Section 7-3 of the Columbus City Charter requires that if territory is annexed into the city after the adoption of the districting plan, council shall by ordinance, which shall be an emergency measure, amend the districting plan to attach the territory to the contiguous council district sharing the largest boundary with the territory. If territory is detached from the city after adoption of the districting plan, council shall by ordinance, which shall be an emergency measure, amend the districting plan to detach the territory from the council district within which it previously resided. This ordinance amends the Columbus District Map to reflect any annexations that have taken place from 2021 through July 2023.

Passage of this ordinance is contingent upon the passage of all ordinances outlined in Section 2.

EMERGENCY ACTION: Emergency action is requested in order to comply with Sec. 7-3 of the Columbus City Charter requiring that the ordinance amending a districting plan be an emergency measure as it is immediately necessary to authorize the adoption of this amended map to ensure that all residents that have been annexed into the City of Columbus are properly accounted for in time for the next general municipal election thereby preserving the public peace, property, health, or safety.

FISCAL IMPACT: None

To amend the Columbus District Map to reflect any annexations to the city from 2021 through July 2023; to enact Chapter 104 of the Columbus City Codes, Administrative Code to memorialize the Columbus District Map within the Columbus City Codes; and to declare an emergency.

WHEREAS, Columbus voters overwhelmingly voted in support of Issue 3 in May 2018, to add two additional seats to City Council and create residential districts in the City of Columbus; and

WHEREAS, a five-member independent, citizen-led commission was seated prior to March 1, 2021 and charged with creating three Council residential districting plans in accordance with the Columbus City Charter (the “Charter”); and

WHEREAS, the Charter mandated that the Commission follow specific requirements when creating the district map; and

WHEREAS, the Charter mandated specific requirements for preserving the map; and

WHEREAS, an emergency exists in that the Charter requires that adoption of an amended map be passed as an emergency measure as it is immediately necessary to authorize the adoption of this amended map to ensure that all residents that have been annexed into the City of Columbus are properly accounted for in time for the next general, municipal election thereby preserving the public peace, property, health, or safety; **NOW,**

THEREFORE,

BE IT ORDAINED BY THE COUNCIL OF THE CITY OF COLUMBUS:

SECTION 1. That the City Council hereby recognizes its obligation under Section 7-3 of the Columbus City Charter to amend the Columbus District Map to include any annexations to the city.

SECTION 2. That the City Council finds the following ordinances to have accepted petitions to annex parcels into the City of Columbus since the effective date of the Columbus District Map:

- 2402-2021
- 2403-2021
- 2598-2021
- 0076-2022
- 0077-2022
- 0926-2022
- 1153-2022
- 1603-2022

- 1830-2022
- 1602-2022
- 2667-2022
- 1831-2022
- 1834-2022
- 2934-2022
- 0036-2023
- 0266-2023
- 0265-2023
- 0262-2023
- 0800-2023
- 0803-2023
- 1483-2023
- 1485-2023
- 1674-2023
- 1675-2023
- 1818-2023
- 1822-2023
- 1824-2023
- 1961-2023
- 1963-2023
- 1964-2023
- 1966-2023
- 2171-2023
- 2173-2023

SECTION 3. That the Council hereby amends the Columbus District Map, pursuant to the requirements of Sec 7-3 of the Charter, by assigning the parcels associated with the ordinances listed in Section 2 to districts as indicated in the attached **Exhibit A**.

SECTION 4. That new Chapter 104 of the Columbus City Codes, Administrative Code is hereby enacted to read as follows:

Chapter 104 - COUNCIL DISTRICTS

Section 104.01 - Division of City into Council Districts

(A) City Council has adopted the Official Columbus District Map in digital form and deems the digital district map to be the Official Columbus District Map. This map contains the Council districts and all overlay boundaries as described in this Code and conforms to provisions of the Columbus City Charter and all ordinances and laws related to the Columbus District Map that are now in effect and which in the future may be in effect.

(B) The repository for the Official Columbus District Map, in any form including digital, is the Department of Technology. Responsibility for maintenance of the Official Columbus District Map is established in the Department of Technology.

(C) City Council shall have the authority to determine what district annexed land should be added to. Council shall also have the authority to make determinations as to district boundaries when a conflict exists in determining exact district boundaries as indicated on the Official Columbus District Map.

SECTION 5. That for the reasons stated in the preamble hereto, which is hereby made a part hereof, this ordinance is hereby declared to be an emergency measure and shall take effect and be in force from and after its passage and approval by the Mayor or ten days after passage if the Mayor neither approves nor vetoes the same.

Legislation Number: 2299-2023

Drafting Date: 7/26/2023

Current Status: Passed

Version: 1

Matter Type: Ordinance

This ordinance authorizes the City Clerk to enter into a grant agreement with Columbus Fashion Council in support of their Fashion Week event and programming.

The Columbus Fashion Council supports small, local businesses, including minority and women entrepreneurs, by giving emerging brands a platform for creative and business opportunities. Over the last 14 years, the Columbus Fashion Council has elevated hundreds of brands and evolved into a business resource organization.

Emergency legislation is needed in order to provide funds to the Columbus Fashion Council in advance of the September Fashion Week event, including providing upfront funding for deposits and other payments on necessary supplies and rentals for the event.

Fiscal Impact: Funding to support this expenditure is available within the general fund and the Job Growth subfund.

To authorize the City Clerk to enter into a grant agreement with Columbus Fashion Council to support the Fashion Week event and programming; to authorize an appropriation within the Job Growth subfund; to authorize a transfer of appropriations within the general fund; to authorize an expenditure from the general fund; and to declare an emergency. (\$50,000.00)

WHEREAS, the Columbus Fashion Council is a business resource organization that is leading the way in providing opportunities to local fashion entrepreneurs; and

WHEREAS, Columbus City Council seeks to promote pathways out of poverty and good-paying jobs, including through entrepreneurship; and

WHEREAS, an emergency exists in the usual daily operation of the Clerk's Office in that it is immediately necessary to authorize the Clerk to enter into a grant agreement with Columbus Fashion Council to support their Fashion Week event and programming; **NOW, THEREFORE**,

BE IT ORDAINED BY THE COUNCIL OF THE CITY OF COLUMBUS:

SECTION 1. That the City Clerk is hereby authorized to enter into a grant agreement with the Columbus Fashion Council in support of the Fashion Week event and programming.

SECTION 2. That the City Auditor is hereby authorized and directed to appropriate \$25,000.00 in the Job Growth subfund, fund 1000, subfund 100015, to the City Clerk per the accounting codes in the attachment to this ordinance.

SECTION 3. That the City Auditor is hereby authorized and directed to transfer appropriations within the general fund per the accounting codes in the attachment to this ordinance.

SECTION 4. That the expenditure of \$50,000.00 or so much thereof as may be needed pursuant to the action authorized in SECTION 1 of this ordinance, is hereby authorized per the accounting codes in the attachment to

this ordinance.

SECTION 5. That the funds necessary to carry out the purpose of this ordinance are hereby deemed appropriated, and the City Auditor shall establish such accounting codes as necessary.

SECTION 6. That the City Auditor is authorized to make any accounting changes to revise the funding source for all contracts or contract modifications associated with this ordinance.

SECTION 7. That for the reasons stated in the preamble hereto, which is hereby made a part hereof, this ordinance is hereby declared to be an emergency measure and shall take effect and be in force from and after its passage and approval by the Mayor or ten days after passage if the Mayor neither approves nor vetoes the same

Legislation Number: 2305-2023

Drafting Date: 7/26/2023

Current Status: Passed

Version: 1

Matter Type: Ordinance

The Ohio History Connection (OHC) and James Preston Poindexter Foundation (JPFF) have met and compiled preliminary planning for the Poindexter Village Museum and Cultural Center (PVMCC). The PVMCC will showcase the rich untold story of an African American experience in its neighborhood and beyond in order to nurture understanding, inspire success, inform action and empower future generations to build the strong, vibrant and just community they want to live in. This ordinance authorizes the Director of Development to enter into a contract with Priscilla Tyson Consulting, LLC (PTC, LLC) to assist in the completion and opening of the PVMCC. Priscilla Tyson Consulting, LLC will do all of the following:

- Establish goals, timelines and objectives toward the completion and opening of the Poindexter Village Museum and Cultural Center on time, on budget and with sufficient operation funding;
- Meet with individuals and groups to review PVMCC work-to-date, identify additional potential stakeholders and provide support and advice through ongoing meetings;
- Review findings that will be compiled into a comprehensive report of activities to date, suggested next steps and advice on any gaps or additional planning that will serve the project to completion;
- Work with all stakeholders to identify the formal and defined roles of the museum's governance;
- Develop a report and research which will include identifying key components for the design process to integrate museum programming;
- Identify key finance planning needs including: capital and operation cost needs, endowment planning, potential partnerships, and role of the Poindexter Village Advisory Committee.

BID WAIVER INFORMATION: The Department of Development is requesting a Bid Waiver on this contract as PTC, LLC has years of experience engaging the Poindexter Community and is uniquely positioned to establish the coalition necessary to accomplish the goal.

FISCAL IMPACT: The funding of \$100,000.00 is available within the Neighborhood Initiatives subfund.

To authorize the Director of the Department of Development to enter into a contract with Priscilla Tyson Consulting, LLC to assist in the completion and opening of the Poindexter Village Museum and Cultural Center (PVMCC); to authorize the appropriation and expenditure within the Neighborhood Initiatives subfund; and to waive the competitive bidding provisions of the Columbus City Codes. (\$100,000.00)

WHEREAS, Poindexter Village was established in the then-segregated East Side of Columbus as the first public housing in Columbus, and one of the first in the United States; and

WHEREAS, the Ohio History Connection and James Preston Poindexter Foundation have met and compiled preliminary planning for the Poindexter Village Museum and Cultural Center (PVMCC); and

WHEREAS, PVMCC will showcase the rich untold story of an African American experience in its neighborhood and beyond in order to nurture, understanding, inspire success, inform action and empower future generations to build the strong, vibrant and just community they want to live in;

WHEREAS, it is in the best interest of the Department of Development to waive the competitive bidding requirements of Chapter 329 of the Columbus City Code because this organization has years of experience engaging the Poindexter Community and is uniquely positioned to establish the coalition necessary to accomplish the goal; **NOW THEREFORE**,

BE IT ORDAINED BY THE COUNCIL OF THE CITY OF COLUMBUS:

SECTION 1. That the Director of Development is authorized to enter into a contract with Priscilla Tyson Consulting, LLC to assist in the completion and opening of the Poindexter Village Museum and Cultural Center PVMCC, in an amount not to exceed \$100,000.00.

SECTION 2. That the City Auditor is authorized and directed to appropriate \$100,000.00 in the Neighborhood Initiatives subfund, fund 1000, subfund 100018, to Columbus City Council per the accounting codes in the attachment to this ordinance.

SECTION 3. That the expenditure of \$100,000.00 or so much thereof as may be needed pursuant to the action authorized in SECTION 1, is hereby authorized in the Neighborhood Initiatives subfund, fund 1000, subfund 100018, per the accounting codes in the attachment to this ordinance.

SECTION 4. That the funds necessary to carry out the purpose of this ordinance are hereby deemed appropriated, and the City Auditor shall establish such accounting codes as necessary.

SECTION 5. That the City Auditor is authorized to make any accounting changes to revise the funding source for all contracts or contract modifications associated with this ordinance.

SECTION 6. That this Council finds it in the best interests of the City to waive the competitive bidding provisions of City Code Chapter 329 to enter into a contract with Priscilla Tyson Consulting, LLC.

SECTION 7. That this ordinance shall take effect and be in force from and after the earliest period allowed by law.

1871-2023 Attachment Title 33 Updates and Typographic Corrections

3303.00 - ~~Italicized words~~ Meaning of words and phrases.

(A) The definitions in this chapter shall apply in the interpretation and enforcement of this Zoning Code.

(B) Italicized words or phrases contained within or as part of a definition in this chapter or otherwise as used throughout the Zoning Code have specific meanings and definitions.

(C) Tense—Number—Lot—Building. For the purposes of this Zoning Code, the following terms, phrases, words, and their derivations shall have the meaning given herein. When not inconsistent with the context, words used in the present tense include the future, words in the plural number include the singular number, and words in the singular number include the plural number.

(D) The word "lot" includes the word "plot," and the word "building" includes the word "structure." ~~Italicized words or phrases contained within or as part of a definition in this chapter or otherwise as used throughout the Zoning Code have specific meanings and definitions.~~

3303.01 Letter A.

"Abutting" means bordering.

"Accessory" means a subordinate use, building or structure located on the same lot with and of a nature incidental to the principal use, building or structure.

"Accessory Parking" and "Non-accessory Parking."

1. "Accessory parking" means automobile parking as a subordinate use and of a nature incidental to but supportive of the principal use, building or structure. Accessory parking is characterized as a free service for employees and/or customers of the principal use, building or structure.

2. "Non-accessory parking" means automobile parking as a principal rather than a subordinate land use and is neither accessory nor code-required. Non-accessory parking is generally characterized as a commercial service.

"Activities, specified sexual." (See "Specified sexual activities.")

"Activity" means an individual tenant, business, or other commercial or noncommercial establishment or occupancy.

"Addition" means a part added to a building either by constructing so as to form one architectural whole, or by joining, as by a passage, so that each is a necessary adjunct or appurtenance of the other or so that they constitute the same building.

"Administrator" when used without clarification means the director or designee.

"Adult booth" means an area of an adult entertainment establishment or adult store separated from the rest of a building by a divider, partition or wall and used to:

1. Demonstrate, play, or show adult material, or

2. View a live performance distinguished or characterized by an emphasis on the depiction description, exposure, or representation of specified anatomical areas or the conduct or simulation of specified sexual activities

"Adult entertainment establishment" means an auditorium, bar, cabaret, concert hall, nightclub, restaurant, theater or other similar commercial establishment that recurrently features or provides one or more of the following

1. Persons who appear in the nude;

2. A live performance distinguished or characterized by an emphasis on the depiction, description, exposure, or representation of specified anatomical areas or the conduct or simulation of specified sexual activities, or

3. Audio or video displays, computer displays, films, motion pictures, slides or other visual representations or recordings characterized or distinguished by an emphasis on the depiction, description, exposure or representation of specified anatomical areas, or the conduct or simulation of specified sexual activities.

"Adult material" means items consisting of one or more of the following

1. Digital or printed books, magazines, periodicals, audio, video displays, computer displays, films, motion pictures, slides, or other visual representations or recordings that are characterized or distinguished by an emphasis on the depiction, description, exposure, or representation of specified anatomical areas or the conduct or simulation of specified sexual activities, or
2. Devices, instruments, novelties or paraphernalia designed for use in connection with specified sexual activities, or that depict or describe specified anatomical areas.

"Adult store" means one or more of the following:

1. An establishment which has a majority of its shelf space or square footage devoted to the display, rental, sale, or viewing of adult material for any form of consideration
2. An establishment with an adult booth.

"Aggregate Graphic Area." (See "Graphic area.")

"Alley" means a right-of-way not less than ten feet wide but less than 35 feet wide located at the rear or side of lots, dedicated to public use for travel or transportation and generally affording secondary access to abutting property.

"Alley line" means a lot line bordering on an alley.

"Alter" or "Alteration," and "Structural Alteration."

"Alter" or "alteration" means any change, rearrangement or modification in construction or in the exit facilities or the moving of partitions from one location or position to another.

"Structural alteration" means any change in the supporting members of a building such as bearing walls, columns, lintels, beams or girders or floor construction.

"Amusement park" means any premises offering three or more amusement rides for hire on a per use basis or the charging of an admission fee for more than 21 calendar days in a calendar year. An amusement ride is a ride or device, aquatic device, or a combination of devices that carries or conveys passengers on, along, around, over, or through a fixed restricted course within a defined area for the purpose of giving its passenger's amusement pleasure, or excitement.

"Amusement ride" includes carnival rides, bungee jumping, inflatable rides and fair rides. Amusement park does not include an approved special event allowed by C.C. Chapter 3390.

"Anatomical areas, specified" (See: "specified anatomical areas.")

"Animal kennel" or "animal shelter" means any building, structure, or premises which is used, arranged, intended or designed to be used for the boarding and/or breeding of animals for more than a consecutive 24-hour period and not located or operated in conjunction with the practice of a licensed veterinarian on the same parcel. Pet day care, pet grooming facilities, pet stores and pet supply stores, with no outside runs, shall not be considered an animal kennel.

"Animated Graphic" (See "Graphic.")

"Antenna" means any system of wires, poles, rods or similar devices for transmitting or receiving radio signals or television signals, or both, together with the structure used for the primary purpose of supporting same, including the foundation, guys, and all other components thereof.

"Apartment complex" means a residential development under one control and consisting of two or more apartment houses erected on a lot which has frontage on and access to a public street through an approved system of private drives. In addition to apartment house buildings, an apartment complex may also include dwellings containing one, two, three, or four dwelling units.

"Apartment hotel" means a building arranged, intended or designed to be occupied by five or more individuals or groups of individuals living independently but having a common heating system and a general dining room.

"Apartment house" means a building arranged, intended or designed to be occupied by five or more individuals, groups of individuals or families living independently of each other and with cooking facilities for the exclusive use of each of the individuals, groups of individuals, or families who occupy the premises. The number which an apartment house is designed to accommodate shall be determined by the number of separate dwelling units in such dwelling.

"Approved combustible material" means wood or any material not more combustible than wood, as specified in the most recent National Electrical Code; and approved plastics.

"Architectural decoration" means an element, design or motif, other than an architectural feature; installed, attached, painted or applied to the exterior of a building or structure for the purpose of ornamentation or artistic expression (Compare with "Architectural feature.")

"Architectural feature" means a window, door or other element of building design intended to be functional and any ornamentation associated therewith. (Compare with "Architectural decoration.")

"Architectural review commission" when used without clarification means the historic resources commission created by Chapter 3117, C.C., or an architectural review commission created by Title 31, C.C. and having jurisdiction over the application.

"Architectural review commission guidelines" means the document adopted by an architectural review commission that sets forth the architectural characteristics of a listed property or an architectural review commission area, or a specific property therein and provides design guidance for appropriate construction or alteration therein pursuant to the provisions of the pertinent chapter. Guidelines and standards are intended to be consistent with each other.

"Art Gallery" means an establishment used primarily for displaying and/or offering for sale works of art to the general public and does not involve the preparation of food or drink or offering food or drink for sale or for consumption on site.

"Arterial street" means any street for which the primary function is to move vehicles from one section of the city or county and which is so designated on the city of Columbus thoroughfare plan and arterial construction type adopted by city council and used for express, moderate speed travel (usually 35 to 50 miles per hour) within an urbanized area.

"Automatic changeable copy." (See "Changeable copy.")

Aviation Field. See "Landing field."

"Awning" means a hood or cover that projects from the wall of a building intended only for shelter or ornamentation.

"Fixed awning" means an awning constructed with a rigid frame which cannot be retracted, folded or collapsed.

"Illuminated awning" means a fixed awning covered with a translucent membrane and which is in whole or part, illuminated by light passing through the membrane from within the structure, also known as an "electric awning."

"Retractable awning" means an awning, which can be, retracted, folded, or collapsed against the face of the supporting building.

"Canopy" means an awning, which is additionally supported by one or more columns.

"Marquee" means a fixed awning or canopy, which requires additional loading for graphics.

3303.02 Letter B.

"Banner" means a non-rigid cloth, canvas, or plastic graphic, other than a flag, displaying on-premises or off-premises copy.

"Bar" means an establishment used primarily for the dispensing, or sale of alcoholic beverages by the drink for on-site consumption.

"Bikeway" means a facility that explicitly provides for bicycle travel. A bikeway may vary from a completely separated facility to simple signed streets as follows:

(a) "Shared-use path" (Class I Bikeway) means a bikeway outside the traveled way and physically separated from motorized vehicular traffic by an open space or barrier and either within the street or highway right-of-way or within an independent alignment. A shared-use path also may be used by pedestrians, including skaters, joggers, users of manual and motorized wheelchairs, and other authorized motorized and non-motorized users.

(b) "Bike lane" (Class II Bikeway) is a marked lane contiguous to a travel lane within a roadway for the exclusive or semi-exclusive operation of bicycles in the same direction as the adjacent travel lane. The bike lane is physically separated from motor vehicle traffic by painted lines, pavement coloration, curbing, parked vehicles or other barriers.

(c) "Bike route" (Class III Bikeway) utilizes existing streets and roads. No separation of motor vehicle and bicycle traffic is provided as only signs are present to indicate the course of the bike route.

"Billboard" means an off-premises sign which consists of one or more sign faces primarily intended by the sign owner to be available for sale, lease or rental for the purpose of promoting any business or other activity which is not situated on the same property as the billboard or of promoting any product or service which is not primarily available on the same property as the billboard; and incidentally used for the display of public service messages.

~~"Boarding house" means a residential building, other than a hotel, in which meals are served together with lodgings for hire to three or more persons.~~

"Breezeway" means a roofed, weather-protected, non-habitable space connecting a dwelling and a detached garage.

"Building" means any structure having a roof supported by columns or walls, or any series of structures separated only by "fire separations" but contained under a common roof or within common walls, and requiring a building permit in accordance with Title 41 of the Building Code that is used for shelter, occupancy, enclosure, or support of persons, animals, or property.

"Building line" means a clearance line limiting the approach to a lot line of a building exclusive of open porches, steps, terraces, walkways or separate accessory building, or as otherwise provided in this Zoning Code.

3303.06 Letter F.

"Facing," in reference to a sign, means the readable copy area visible to traffic proceeding in one direction along a public street.

"Fast-food business" means a retail business operation, established on an individual tract of land or lot, occupying less than 10,000 square feet of gross floor area, where the products purchased by the customer consist of prepared food and beverages ready for immediate consumption.

"Filling Station." See "Retail Filling Station."

"Finished grade" means the final elevation of the ground plane after development.

"Fireworks" means any pyrotechnic devices classified as fireworks under C.C. Chapter 2533.

"Firing range" means any non-publicly owned property or premises designed or used for the discharging of a firearm, including air rifles and air pistols. A game or exhibit that includes the use of an air rifle or air pistol exclusively for a period of no more than 21 calendar days in a single calendar year shall not be considered a firing range for purposes of this Code.

"Fit to display" means, in the context of a flag or banner, that the entire flag or banner and supporting structure is in good and safe condition, with no holes, and that is not tattered, substantially faded or reduced in readability, or that is in a state of mechanical deterioration.

"Flag" means an ensign, standard, colors, or emblem of a governmental body.

Flashing Graphic. See "Graphic."

"Flood plain development." See C.C. Chapter 1150 3385.

"Freeway" means an arterial street with full control of access, and complete grade separation at all crossroads. Freeways accommodate heavy traffic at high speeds (usually usual 55 or greater to 65 miles per hour).

"Front line of a building" and "front yard line" mean, respectively, that portion of the building line or yard line adjacent to the street line affording principal access to the building. (See also "Lot front.")

"Frontage," of a building, and of a lot or property:

1. "Building frontage" means the facade of a building most nearly parallel to an abutting public right-of-way which affords principal access.
2. "Lot frontage" or "property frontage" means the length of the property line of any one premises along an abutting public right-of-way.

"Fronting" means bordering, in the sense of affording principal access.

"Fuel sales" means the retail sale of fuel for motor vehicles.

3303.13 Letter M.

"Maintenance" means, in reference to a graphic, cleaning, painting, repair, or replacement of defective parts in a manner that does not alter the basic copy, design, or structure.

Manual Changeable Copy. See "Changeable copy."

"Manufactured home" means a building unit or assembly of closed construction that is fabricated in an off-site facility and constructed in conformance with the federal construction and safety standards established by the secretary of housing and urban development pursuant to the "Manufactured Housing Construction and Safety Standards Act of 1974," 88 Stat. 700, 42 U.S.C.A. 5401, 5403 and that has a permanent label or tag affixed to it, as specified in 42 U.S.C.A. 5415, certifying compliance with all applicable federal construction and safety standards.

"Manufactured home pad" means that portion of a manufactured home site that is designed, constructed, and improved in such a manner as to provide a base upon which a manufactured home shall rest, and which also serves as a base upon which blocks or other materials are placed to assist in leveling the floor of the manufactured home and provide a temporary type of foundation.

"Manufactured home park" means one or more contiguous parcels of land under a single management which have been designed and developed in such a manner as to provide individual manufactured home sites for one or more manufactured homes. The term manufactured home park shall mean the same as a trailer park, trailer court, or trailer camp; however, only mobile homes or trailers with the HUD certification shall be located therein.

"Manufactured home site" means an area of land within a manufactured home park that is designed and developed in such a manner as to provide a location for one manufactured home.

Manufacturing Use. See "Use, institutional, commercial or manufacturing."

Marquee. See "Awning, fixed."

"Meat packing plant" means a place, other than a slaughterhouse, where animals other than fowl or game are processed, cured and/or made ready for cold storage or sale.

"Message center" means an automatic changeable copy sign, a display capable of transmitting variable information to the public, such as the date, time and temperature; public service messages; or a wide variety of promotional announcements.

"Minimum floor area" means that area computed for the floors in the dwelling above the lot grade line. The second floor in each case qualifying for living quarters shall have access thereto by a permanent built-in stairway. "Minimum net floor area for living quarters" excludes rooms for garage purposes, outside vestibules, and open or closed porches or verandas. "Living quarters" means that portion of the building which is constructed with ceilings and walls finished on the inside in accordance with the Building Code.

"Mobile home" means any vehicle manufactured as a single-family residence, comprised of one or more sections, excluding recreational vehicles, which has been designed and manufactured for transportation on the public streets and highways on its own wheels, arriving at the site ready for occupancy except for normal unpacking, assembly operations and connections to utilities. This term shall not include a modular home as defined in this chapter, or an industrialized unit as defined in Section 3781.10 of the Ohio Revised Code, but includes a manufactured home as defined in this chapter.

"Modular home" means a residence comprised of one or more self-sufficient sections, except site preparations, transported on a vehicle from the place of manufacture to a site where it is to be occupied as a dwelling. This term shall not include a mobile home or a manufactured home.

"Monopole telecommunication antenna" means the combination of a single tubular or rod-shaped support structure and transceiving devices, including, but not limited to, panel and whip antennas, used to facilitate wireless radio and telecommunication transmissions. This definition excludes lattice, guyed, dish, or erector-style antennas.

Monument Sign. See "Sign."

Motel. See "Hotel."

"Motorist services use" means an activity or land use providing fuel, food or lodging and described as a "motorist services use" by the Ohio Manual on Uniform Traffic Control Devices (OMUTCD), latest revision.

Multi-Faced Sign. See "Sign."

"Multiple-dwelling development" means a residential development under one control and consisting of ~~two three~~ or more multiple-dwelling buildings ~~dwelling~~s each containing a minimum of two and a maximum of three or four dwelling units erected on a lot which has frontage on and access to a public street through an approved system of private drives. In addition to multiple-dwelling buildings, a multiple-dwelling development may also include single-unit dwellings.

"Mural" means a graphic displayed on the exterior of a building, generally for the purposes of decoration or artistic expression without on- or off-premise advertising or commercial copy, including, but not limited to, painting, fresco or mosaic. A mural that qualifies as an on- or off-premise sign shall be classified as a sign and not a mural.

3303.16 Letter P.

"Panel antenna" means the combination of a rectangular panel not to exceed two feet wide by six feet tall by six inches deep and any associated support structure used to facilitate wireless radio and telecommunication transmissions. This definition excludes lattice, guyed, dish or erector-style antennas.

"Parking space" means a rectangular area, exclusive of any driveway or other circulation area, accessible from a street, alley, or maneuvering area and designed for parking a motor vehicle.

"Parking lot" means any off-street area or facility which meets one of the following conditions:

1. Contains one or more parking, loading or stacking space for commercial, institutional or industrial use; or
2. Contains five or more parking spaces for any residential use.

"Pennant" means a flag or banner that is triangular in shape. (See "Banner," "Flag" and "String of pennants.")

Permanent Sign. See "Sign."

"Person" means, without limitation, a natural person, the person's beneficiaries, executors, administrators, or assigns, and also includes a corporation, partnership, an unincorporated society or association, or any other type of business or association, including respective successors or assigns, recognized now or in the future under the laws of the state or the city.

"Personal assistance" means supervision as required and services including help in walking, bathing, dressing, feeding, or getting in and out of bed.

"Pickup unit" means a building or portion thereof that, by design, permits customers to receive goods or services while remaining in a motor vehicle.

"Pitch" means the slope of a roof expressed in feet as a ratio of vertical rise to horizontal run.

"Pole cover" means a decorative enclosure that covers the structural support of a sign.

"Porch" means a roofed platform projecting from a building at an entrance and is separated from the building by the walls of the building, and is partially supported by piers, posts or columns. A porch may be open, enclosed or partially enclosed. "Open porch" means a porch which is unenclosed (except possibly for screens) by anything higher than 36 inches above the floor except for the roof and roof supports.

"Portable building" means any building or vehicle designed with running gear permanently attached for transportation on the public streets and highways under its own power or towed behind another vehicle, arriving at the site, substantially ready for use, whether for residential, office, commercial or manufacturing use. Removal of packing and baffles; interconnection of two or more buildings or vehicles; and connection of or to utilities shall not be considered in determining whether a portable building is substantially ready for use. The towing hitch, wheels, axles, and other running gear may not be removed ~~remove~~ from a portable building preventing it from being portable.

Portable Sign. See "Sign."

"Portable storage container" means a non-permanent, non-habitable, self-contained structure of less than 169 square feet in size and eight feet in height designed for temporary placement on and subsequent removal from a parcel for the purpose of facilitating off-site storage.

"Premises" means land together with the buildings and structures thereon.

"Primary building frontage" means a building frontage that abuts a street listed as a primary street in the applicable overlay areas.

"Principal building" means a building in which the principal use of the property is conducted. All parcels containing at least one building shall be deemed to have a principal building.

"Private access" means driveway as defined and regulated in the parking chapter hereof.

"Private club" means a building and accessory facilities owned and operated by an association, a corporation, or a group of individuals established for the cultural, educational, recreational, or social enrichment of its members and not primarily for profit, and whose members pay dues and meet certain prescribed qualifications for membership.

"Private garage" means a building or portion of a building for the housing of motor vehicles as an accessory use permitted in a residential district or an apartment district and in which no service, work, trade, occupation, or business is carried on connected in any way with a motor vehicle as defined by Ohio Revised Code Section 4511.01.

"Private residence" means a place of usual or customary abode.

"Private roadway" means a privately owned and maintained strip of land designed, improved, and intended to be used for vehicular traffic.

"Produce Stand" means a stand that is an open and non-enclosed structure that is not a building and does not exceed 120 square feet in gross floor area for the display, sale, and/or pickup of fresh, unprocessed vegetables or produce (as defined by Chapter 3717 of the Ohio Revised Code), flowers, orchard products, or ornamental crops. The stand shall not employ the use of appliances or mechanical refrigeration.

Projecting Sign. See "Sign."

Projector Graphic. See "Graphic."

Property Frontage. See "Frontage."

Property Owner. See "Owner."

"Public garage" means any building or portion of a building other than a private garage, for the housing of commercial or noncommercial motor vehicles.

"Public notice" of a hearing or proceedings means ten days' notice of the time and place thereof printed (see "printed" in 101.03 Interpretation) in The City Bulletin.

"Public nuisance" means any structure which is permitted to be or remain in any of the following conditions:

- (A) In a dilapidated, decayed, unsafe or unsanitary condition detrimental to the public health, safety, and welfare, or well-being of the surrounding area; or
- (B) A fire hazard; or
- (C) Any vacant building that is not secured and maintained in compliance with Chapter 4513; or
- (D) Land, real estate, houses, buildings, residences, apartments, or premises of any kind which are used in violation of any division of Section 2925.13, Ohio Revised Code.

"Public nuisance" also means any structure or real property which is not in compliance with any building, housing, zoning, fire, safety, air pollution, health or sanitation ordinance of the Columbus City Code or Columbus City Health Code, or any real property upon which its real property taxes have remained unpaid in excess of one year from date of assessment.

"Public police station" means all government police uses including but not limited to police stations and substations; police headquarters; community policing centers; police heliports; police administrative offices; and police academies.

"Public service announcement" means a temporary graphic display for the purpose of informing the public about events or activities involving the arts, or involving community service or not-for-profit organizations.

"Public-private setback zone" means an area between a principal building and a public street utilized for seating, outdoor dining, public art and/or other pedestrian amenities.

Public Sign. See "Public graphic" and "Sign."

"Public way" means an alley, boulevard, bridge, channel, ditch, easement, expressway, freeway, highway, lane, parkway, right-of-way, road, sidewalk, street, subway, tunnel, viaduct, walk or other way in which a public entity has a proprietary right, or which is dedicated whether or not it has been improved.

3305.051 Fees - Refund.

(A) Unless specifically indicated in the fee schedule, department refund policy or this code, all fees are not refundable.

(B) In the event of a refund, a refund service fee, as indicated in the fee schedule or department refund policy, and any costs for services already provided, shall be deducted from the amount to be refunded.

(C) The eligibility, process, and any required refund fee shall be as indicated ~~indicted~~ in the Department refund policy.

(D) The Director may waive the refund fee if the director finds that the refund is necessary because of an error on the part of a city employee. In the event any refund due is less than the required refund fee, no balance shall be due or returned.

3305.07 Enforcement.

~~The Director of the Department of Building and Zoning Services, or their designee. The director of the department of development and the director of the department of building and zoning services, or their designees,~~ shall have the power to enforce all provisions of this Zoning Code and may institute any appropriate action or judicial proceeding to prevent the unlawful construction or alteration of any building or structure or the unlawful establishment, change or modification or any use; to restrain, correct or abate such violations; or to prevent occupancy of the unlawful building or structure. Strict liability shall be the standard for enforcement.

3309.03 Establishment of districts.

For the purpose of this Zoning Code the city is divided into classes of use districts, height districts and area districts as provided for by this code and as may be indicated in this chapter hereafter.

3309.04 Multiple use districts.

The following multiple districts are established and their ~~its~~ designating symbols ~~symbol~~ shall be:

Planned Community District PC

Downtown District DD

East Franklinton District EFD

Traditional Neighborhood Development NE, NG, NC, TC

3309.10 Commercial use districts.

The following commercial use district are established and their designating symbols shall be:

C-1 Commercial District C-1

C-2 Commercial District C-2

C-3 Commercial District C-3

C-4 Commercial District C-4

~~C-5 €-S Commercial District~~ ~~C-5 €-S~~

~~Central Business District~~ ~~CB~~

~~Civic Center District~~ ~~CC~~

Commercial Planned Development District CPD

3311.11 Site plan to accompany building permit application.

Applications for all building permits for new construction or remodeling shall be accompanied with a site plan, showing the description of land and any proposed building construction so as to readily ~~to~~ identify and definitively ~~definitely~~ locate said land and building, showing the distances from the side lot lines to adjacent buildings on the same lot or adjacent lots, showing any off-street parking areas as designated by this Zoning Code for the various use districts, and showing the location of existing rights-of-way.

3311.30 Site plan to accompany building permit application.

Applications for all building permits for new construction or remodeling shall be accompanied with a site plan, showing the description of land and any proposed building construction so readily to identify and definitively locate ~~definitely located~~ said land and building, showing the distances from the side lot lines to adjacent buildings on the same lot or adjacent lots, showing any off-street parking areas as designated by this Zoning Code for the various use districts, and showing the location of existing rights-of-way.

3312.55 Electric vehicle parking requirements purpose and applicability.

A. Purpose.

The requirements of Sections 3312.55 to 3312.58 are intended to provide equitable electric vehicle charging access distributed throughout the City to support electric vehicle adoption, improve air quality, and achieve City climate and equity goals.

B. Applicability.

The requirements of Sections 3312.55 through 3312.58 shall apply only to applications for certificate of zoning clearance for newly constructed parking lots or parking structures received on or after the effective date of January 1, 2024.

C. Exemptions.

The following building types and structures are exempt from the requirements of Sections 3312.55 through 3312.58:

1. Very Low Income Housing, where 50% or more of the units are constructed to serve tenants with incomes 50% or below the Area Median Income.
2. Permanent Supportive Housing, as defined by the U.S. Department of Housing and Urban Development.
3. Transitional Housing, as defined by the U.S. Department of Housing and Urban Development.
4. Parking lots or structures that do not meet the minimum parking space requirement as noted in Sections 3312.57 or 3312.58 below.

3321.05 Vision clearance.

A. Minimum acceptable vision clearance standards for motorist and pedestrian safety at vehicular access points along streets are hereby established by restricting the placement, opacity, height and configuration of any fence, wall, planting or other obstruction in a required yard. Any person establishing a parking space that uses a driveway leading to a public street shall maintain vision clearance at the intersection of such driveway and street right-of-way line.

1. Clear vision for driveways to parking lots. An owner shall maintain unobstructed vision clearance between the elevations of two and one-half to ten feet above the driveway grade within "clear vision triangles", which are two ten-foot, right-angle triangles formed by the intersection of a driveway pavement edge and street right-of-way line. See Figure 1.

Figure 1.

(See Attachment 1871-2023 3321.05 Figure 1.)

2. Clear vision for other driveways. An owner shall maintain vision clearance on each residential lot abutting a street and having access thereto or abutting a residential lot having such access to a street. No portion of a fence or wall exceeding two and one-half feet in height above the finished lot grade shall exceed 25 percent opacity when located in a required yard having vehicular access to a street or abutting a residential lot having such access to a street. Mature plantings with foliage between two and one-half and six feet above the finished lot grade shall extend no closer than 12 feet to the street right-of-way line. The percentage of opacity shall be determined by measurement of any typical square foot of the vertical surface of the fence or wall from a point perpendicular thereto. See Figures 2 and 3. A motor vehicle parked in a driveway shall extend no closer than ten feet to the street right-of-way line.

Figure 2.

(See Attachment 1871-2023 3321.05 Figure 2.)

Figure 3.

(See Attachment 1871-2023 3321.05 Figure 3.)

B. Minimum acceptable vision clearance standards for motorist and pedestrian safety at intersections are hereby established by restricting the placement, opacity, height and configuration of any fence, wall, planting, structure, or other obstruction.

1. Vision clearance at intersections of streets and alleys. Property owners shall maintain unobstructed vision clearance at the intersections of streets and alleys. An owner shall maintain unobstructed vision clearance between the elevations of two and one-half to ten feet above the alley grade within "clear vision triangles", which are two ten-foot, right-angle triangles formed by the intersection of an alley right-of-way line and street right-of-way line. See Figure 4.

Figure 4.

(See Attachment 1871-2023 3321.05 Figure 4.)

2. Clear Vision at Intersections. A clear vision triangle shall be maintained on each residential lot, including but not limited to, 1-, 2-, or 3-unit; apartment; planned unit development; or planned community development district lot adjacent to a street intersection. Within the clear vision triangle no fence, wall, planting or other obstruction shall exceed two and one-half (2-1/2) feet in height above the centerline grade of the intersecting streets. A "clear vision triangle" is that area of a corner lot bounded on two sides by the intersecting street lines (property lines) and on the

third side by a line connecting two points, one located on each street line 30 feet from the point of intersection. See Figure 5.

Figure 5.

(See Attachment 1871-2023 3321.05 Figure 5.)

3332.18 Basis of computing area.

Area shall be computed based on the following guidelines:

(A) That portion of a corner lot in excess of 7,200 square feet and most distant from the intersecting street abutting the longest dimension of such corner lot shall be considered as an interior lot.

(B) A lot shall be deemed to extend to the center of any alley adjoining the rear lot line or side lot line of such lot. A lot adjoining alleys on more than one side shall be deemed to extend to the center of only one such alley.

(C) In an SR, R-1, R-2, R-3, R-2F, R-4 or MHD area district, if the depth of a lot is more than three times the width of such lot, a depth of only three times such width shall be used in computing density.

(D) No dwelling hereafter erected shall occupy alone or together with any other building greater than 50 percent of the lot area; nor shall any manufactured home hereafter erected occupy alone or together with any building greater than 50 percent of the lot area.

(E) A multiple-dwelling development, as defined in Chapter 3303, C.C., shall be allowed only in an R-4 area district and shall be on a single lot of 20,000 square feet or more in area and under one control. The required minimum lot area per dwelling unit may be calculated utilizing the area of the entire development, including community open spaces, parking spaces, and drives other than public streets, which are within the same lot and accessible to all occupants of the entire development, as well as the private individual space accessible directly to an individual building, ~~but excluding any area dedicated to an individual building,~~ but excluding any area dedicated for public purposes. All street and alley arrangements shall be subject to approval by the director after consultation with the Director of Public Service ~~director of public service~~ and/or their designee. A multiple-dwelling development comprised of parcels within different taxing districts which cannot be combined shall be deemed one lot, subject to applicable lot area per dwelling unit and required yard area(s) being provided. Density computations and yard area(s) shall be calculated for the overall development and not for each individual parcel, and all parcels shall be covered by the same zoning clearance.

(F) No yard or other open space provided for any building for the purpose of complying with the provisions of these regulations shall again be considered as the yard or other open space for any other building; nor shall any yard or other open space provided for any manufactured home for such purpose again be considered as the yard or other open space for any other manufactured home or building.

3332.19 Fronting.

Each dwelling or principal building shall front upon a public street.

However, those ~~dwellings containing three or more~~ dwelling units located in a multiple-dwelling development, as defined in Chapter 3303, C.C., may front upon a private street if such plan is approved by the director after consultation with the Director of Public Service ~~director of public service~~ and/or their designee. Such buildings shall be subject to all regulations pertaining to building lines of both fronting and side streets and corner lot requirements.

3332.37 Home occupation.

The purpose of this section is to permit a home occupation as an accessory use if it is compatible with the residential character of the neighborhood in which it is located and is conducted so as not to have an adverse effect upon the average neighbor under normal circumstances; to set standards by which to judge the operation of such use; and to prohibit uses which are incompatible with permissible uses in residential

districts. A home occupation may be an accessory use in any residential district subject to the following conditions:

- A. Any home occupation use shall be confined to the principal residence of the individual so engaged; shall be excluded from any yard or accessory building; and, shall be clearly incidental and subordinate to the primary residential use.
- B. No alteration shall be made in either the internal or external structural form of the residential building or the external appearance for purposes of any home occupation. The removal of partitions or floors, or parts thereof, shall be construed as an alteration of the external or internal structural form and is, therefore, prohibited.
- C. No evidence of any home occupation shall be visible from off the lot where it is conducted except for no more than one home occupation sign displayed in compliance with C.C. 3376.08(B)(1)-(6).
- D. No more than 20 percent of the livable area of any residence shall be used for a home occupation.
- E. No person other than a permanent resident of the dwelling unit shall be engaged in or employed at any home occupation within such dwelling unit except that in connection with the practice of a profession which can be practiced only with the assistance of supportive personnel, one person not residing in such dwelling unit may be so employed. Profession is limited herein to architect, attorney, clergyman, dentist, engineer, physician or surgeon.
- F. No storage of equipment or materials used in a home occupation shall be outside the principal residence.
- G. No change shall be made in any utility line, meter or service to accommodate a home occupation and utility use shall not unreasonably exceed that normally or previously used at such residence.
- H. No equipment or process shall be used in any home occupation which emits radiation or creates noise, vibration, glare, fumes, odors, or electrical interference detectable to the normal senses off the lot used for such home occupation. In the case of electrical interference, no equipment or process shall be used which creates visual or audible interference.
- I. No traffic shall be generated by any home occupation unreasonably greater in volume or different in nature than would otherwise normally occur in the residential neighborhood in which it is located.
- J. No wholesale or retail business, including the sale or transfer of any firearm, shall be conducted in a dwelling unit.

Provisions of this section relating to a dwelling shall apply equally to a manufactured home only in a MHD manufactured home development district or to any dwelling unit permitted in a commercial zoning district.

3332.38 Private garage.

A private garage in a residential district shall be so located and constructed as to conform to one or more of the following as the case may require:

- (A) A private garage shall not be an accessory use to a lot in a residential district unless such lot is occupied by a dwelling or unless a building permit has been issued for and construction started on a dwelling on such lot;
- (B) When a private garage is built as an accessory use in a terrace or retaining wall on the front side of the lot, such private garage shall not project in front of the terrace or retaining wall more than three feet, and in no case shall it project above the level of the ground (or main) floor of a residence on an adjoining lot;
- (C) No separate private garage building shall be erected in a terrace or retaining wall, closer than the required building line to the street line, or closer than the minimum side yard requirement or building line to an adjoining lot line. On a corner lot a separate private garage building shall not be closer than the building line of the side street to such side street;
- (D) An attached or semi-attached private garage shall have such separation from the dwelling as is specified in the Building Code;
- (E) A private detached garage shall not occupy more than 45 percent of the total rear yard;
- (F) Subject to the limitation of subsection (E) above, no portion of the lot area devoted to a private garage or a carport shall exceed the greater of:

- (1) 720 square feet; or
 - (2) One-third of the minimum net floor area for living quarters of the principal residence; and
- (G) No carport or detached private garage shall exceed 15 feet in height, the perpendicular straight line measured from the curb level, or from the finished grade line of the lot where such grade is higher than the curb, to the highest point of such garage, except that in the university impact district, as defined in Chapter 3325, C.C. 3372.504, in those areas having an architectural review commission as set out in Title 31, Chapters 3319 through 3331, C.C., or in a district or listed property, as defined in Chapter 3116, C.C., the 15 foot height limit may be exceeded in order to achieve a compatible roof pitch provided the University Impact District Review Board ~~University Area review board~~, the appropriate architectural review commission, or the historic resources commission, as the case may be, finds the increased roof pitch is compatible with the established architectural character of the district and further provided the increased roof pitch does not result in habitable space.
- (H) A private garage shall be considered attached to the dwelling only when directly attached to habitable space. Any habitable space in an attached garage must connect directly with habitable space in the dwelling.
- (I) Nothing in subsection (H) above shall prevent a breezeway connection between a house and private garage. The area of the breezeway connection shall be utilized in calculating the percent of total rear yard which may be occupied by a private detached garage as stipulated in subsection (E) above, but shall not be subject to the limitations of subsection (F) above.
- (J) No maintenance, alteration, repair, reconditioning or reconstruction of, or connected in any way with, a motor vehicle, as defined by Ohio Revised Code Section 4511.01, registered to anyone other than a resident of the subject premises shall be carried on or conducted in a private garage.
- (K) Provisions of this section relating to a dwelling shall apply equally to a manufactured home in an MHD manufactured home development district.

3333.02 AR-12, ARLD and AR-1 apartment residential district use.

Within an AR-12, ARLD or AR-1 apartment residential district, no buildings or premises shall be used and no buildings shall be erected which are arranged, intended or designed to be used for other than one or more of the following specified uses:

- (1) Apartment house, as defined in Chapter 3303, C.C., containing five or more dwelling units;
- (2) Apartment complex, as defined in Chapter 3303, C.C. and located on a lot of no less than 20,000 square feet;
- (3) Dwelling containing ~~no fewer than three dwelling units and no more than~~ one, two, three, or four dwelling units, as defined in Chapter 3303, C.C., and in accordance with R-4 standards;
- (4) Multiple dwelling development, as defined in Chapter 3303, C.C. and located on a lot of no less than 20,000 square feet;
- (5) Town house development, as defined in Chapter 3303, C.C., containing no more than eight town houses in a row and no fewer than three town houses in a row, and in accordance with town house development standards;
- (6) Religious Facility;
- (7) School, as defined in Chapter 3303, C.C.;
- (8) Public playground;
- (9) Public park;
- (10) Public library;
- (11) Public museum;
- (12) Public recreation building;
- (13) Water supply reservoir, well, water tower, or filter bed;
- (14) Public or parochial college or university (other than a trade or business institution);
- (15) In accordance with C.C. 3333.055, one single-unit or two-unit dwelling, as defined in Chapter 3303, C.C.
- (16) Adult or child day care center.

3333.025 AR-2 apartment residential district use.

Within an AR-2 apartment residential district, no buildings or premises shall be used and no buildings shall be erected which are arranged, intended or designed to be used for other than one or more of the following specified uses:

- (1) Apartment house, as defined in Chapter 3303, C.C., containing five or more dwelling units;
- (2) Apartment complex, as defined in Chapter 3303, C.C. and located on a lot of no less than 20,000 square feet;
- (3) Dwelling containing ~~no fewer than three dwelling units and no more than~~ one, two, three, or four dwelling units, as defined in Chapter 3303, C.C., and in accordance with R-4 standards;
- (4) Multiple dwelling development, as defined in Chapter 3303, C.C. and located on a lot of no less than 20,000 square feet;
- (5) Town house development, as defined in Chapter 3303, C.C., containing no more than eight town houses in a row and no fewer than three town houses in a row, and in accordance with town house development standards;
- (6) Religious Facility;
- (7) School, as defined in Chapter 3303, C.C.;
- (8) Public playground;
- (9) Public park;
- (10) Public library;
- (11) Public museum;
- (12) Public recreation building;
- (13) Water supply reservoir, well, water tower, or filter bed;
- (14) Public or parochial college or university (other than a trade or business institution);
- (15) Apartment hotel;
- (16) College fraternity, sorority or club house;
- (17) Convent or monastery;
- (18) In accordance with C.C. 3333.055, one single-unit or two-unit dwelling, as defined in Chapter 3303, C.C.;
- (19) Adult or Child day care center.

3333.03 AR-3 apartment residential district use.

Within an AR-3 apartment residential district, no buildings or premises shall be used and no buildings shall be erected which are arranged, intended or designed to be used for other than one or more of the following specified uses:

- (1) Apartment house, as defined in Chapter 3303, C.C., containing five or more dwelling units;
- (2) Apartment complex, as defined in Chapter 3303, C.C. and located on a lot of no less than 20,000 square feet;
- (3) Dwelling containing ~~no fewer than three dwelling units and no more than~~ one, two, three, or four dwelling units, as defined in Chapter 3303, C.C., and in accordance with R-4 standards;
- (4) Multiple-dwelling development, as defined in Chapter 3303, C.C. and located on a lot of no less than 20,000 square feet;
- (5) Town house development, as defined in Chapter 3303, C.C., containing no more than eight town houses in a row and no fewer than three town houses in a row, and in accordance with town house development standards;
- (6) Religious Facility;
- (7) School, as defined in Chapter 3303, C.C.;
- (8) Public playground;
- (9) Public park;
- (10) Public library;
- (11) Public museum;

- (12) Public recreation building;
- (13) Water supply reservoir, well, water tower, or filter bed;
- (14) Public or parochial college or university (other than a trade or business institution);
- (15) Apartment hotel;
- (16) College fraternity, sorority or club house;
- (17) Convent or monastery;
- (18) Community center building, home for the aging, nursing home, rest home, shared living facility, Y.M.C.A., Y.W.C.A., social organization, or philanthropic institution, conditioned per C.C. 3333.07;
- (19) Hospital, infirmary, or orphanage, provided no part of such building shall be located within 50 feet of any lot line other than a street or alley line of the property occupied by such use;
- (20) Rooming house, or the leasing or renting of rooms limited according to C.C. 3333.07;
- (21) Adult or Child day care center;
- (22) In accordance with C.C. 3333.055, one single-unit or two-unit dwelling, as defined in Chapter 3303, C.C.

3333.035 AR-4 apartment residential district use.

Within an AR-4 apartment residential district, no buildings or premises shall be used and no buildings shall be erected which are arranged, intended or designed to be used for other than one or more of the following specified uses:

- (1) Apartment house, as defined in Chapter 3303, C.C., containing five or more dwelling units;
- (2) Apartment complex, as defined in Chapter 3303, C.C. and located on a lot of no less than 20,000 square feet;
- (3) Dwelling containing ~~no fewer than three dwelling units and no more than~~ one, two, three, or four dwelling units, as defined in Chapter 3303, C.C., and in accordance with R-4 standards;
- (4) Multiple-dwelling development, as defined in Chapter 3303, C.C. and located on a lot of no less than 20,000 square feet;
- (5) Town house development, as defined in Chapter 3303, C.C., containing no more than eight town houses in a row and no fewer than three town houses in a row, and in accordance with town house development standards;
- (6) Religious Facility;
- (7) School, as defined in Chapter 3303, C.C.;
- (8) Public playground;
- (9) Public park;
- (10) Public library;
- (11) Public museum;
- (12) Public recreation building;
- (13) Water supply reservoir, well, water tower, or filter bed;
- (14) Public or parochial college or university (other than a trade or business institution);
- (15) Apartment hotel;
- (16) College fraternity, sorority or club house;
- (17) Convent or monastery;
- (18) Community center building, home for the aging, nursing home, rest home, shared living facility, Y.M.C.A., Y.W.C.A., social organization, or philanthropic institution, conditioned per C.C. 3333.07;
- (19) Hospital, infirmary, or orphanage, provided no part of such building shall be located within 50 feet of any lot line other than a street or alley line of the property occupied by such use;
- (20) Adult or Child day care center ~~limited according to C.C. 3333.06;~~
- (21) Rooming house, or the leasing or renting of rooms limited according to C.C. 3333.07;
- (22) College dormitory;
- (23) In accordance with C.C. 3333.055, one single-unit or two-unit dwelling as defined in Chapter 3303, C.C.

3333.04 Permitted uses in AR-O apartment office district.

Within an AR-O apartment office district, no building or premises shall be used and no building shall be erected or altered which is arranged, intended or designed to be used for other than one or more of the following specified uses.

- (1) Apartment house containing five or more dwelling units;
- (2) Dwelling containing ~~no fewer than three dwelling units and no more than~~ one, two, three, or four dwelling units, as defined in Chapter 3303, C.C., and in accordance with R-4 standards;
- (3) Art studio;
- (4) Bank;
- (5) Ecclesiastical, eleemosynary or philanthropic use;
- (6) Office building or offices, including medical offices;
- (7) Photography studio;
- (8) Radio or television studio;
- (9) Telephone exchange together with concealed electric substation necessary for such use;
- (10) Public or private clinic, hospital, infirmary, or orphanage provided no part of such building shall be located within 50 feet of any lot line other than a street or alley line of the property occupied by such use and not for veterinarian purpose;
- (11) School, as defined in Chapter 3303, C.C.;
- (12) Public library;
- (13) Public museum;
- (14) Public recreation building;
- (15) Water supply reservoir, well, water tower, or filter bed;
- (16) Adult or Child day care center;
- (17) Religious facility
- (18) Rooming house, shared living facility or the leasing or renting of rooms limited according to CC. 3333.07;
- (19) In accordance with C.C. 3333.055, one single-unit or two-unit dwelling, as defined in Chapter 3303, C.C.

3333.15 Basis of computing area.

Area shall be computed based on the following guidelines:

- (a) That portion of a corner lot in excess of 7,200 square feet and most distant from the intersecting street abutting the longest dimension of such corner lot shall be considered as an interior lot.
- (b) A lot shall be deemed to extend to the center of any alley adjoining the rear lot line or side line of such lot. A lot adjoining alleys on more than one side shall be deemed to extend to the center of only one such alley.
- (c) No residence building hereafter erected shall occupy alone or together with any other building greater than 50 percent of the lot area.
- (d) A multiple-dwelling development or an apartment complex, as defined in Chapter 3303, C.C., shall be on a single lot of 20,000 square feet or more in area and under one control. The required minimum lot area per dwelling unit may be calculated utilizing the area of the entire development or complex, including community open spaces, parking spaces, and drives other than public streets, which are within the same lot and accessible to all occupants of the entire development or complex, as well as the private individual space accessible directly to an individual building, but excluding any area dedicated for public purposes. All street and alley arrangements shall be subject to approval by the director after consultation with the Director of Public Service ~~director of public service~~ and/or their designee. An apartment complex comprised of parcels within different taxing districts which cannot be combined shall be deemed one lot, subject to applicable lot area per dwelling unit and required yard area(s) being provided. Density computations and yard area(s) shall be calculated for the overall development and not for each individual parcel, and all parcels shall be covered by the same zoning clearance.

(e) No yard or other open space provided for any building for the purpose of complying with the provisions of these regulations shall again be considered as the yard or other open space for any other building.

3333.16 Fronting.

Each dwelling, apartment house or principal building shall front upon a public street. However, those ~~dwelling~~s containing three or more dwelling units located in a multiple-dwelling development, as defined in Chapter 3303, C.C., or apartment houses and dwellings located in an apartment complex, as defined in Chapter 3303, C.C., may front upon a private street if such plan is approved by the director with the Director of Public Service ~~director of public service~~ and/or their designee. Such buildings shall be subject to all regulations pertaining to building lines of both fronting and side streets and corner lot requirements.

3333.259 Prohibited uses and activities.

No person in any residentially zoned district as defined in Chapter 3303, C.C., shall store, collect, park, leave, deposit, maintain, reserve, put aside for future use, permit, allow, or suffer to remain on any porch, balcony, roof, or in a yard except in a completely enclosed building or structure, any:

- (1) Lumber or other building materials except those related to projects for which a valid building permit has been issued and except firewood for the personal use of the resident in the ~~rear~~ rear or side yard;
- (2) Motor vehicle as defined by Ohio Revised Code Section 4511.01, airplane, boat, shipping container, or trailer except as provided for by Chapter 3312 ~~Chapter 3342~~, Off-Street Parking and Loading;
- (3) Parts of any item listed in (2) above including tires;
- (4) Equipment or materials used in the construction trade;
- (5) Machinery or household appliance (not including equipment required for solar energy collection);
- (6) Junk;
- (7) Salvage; or
- (8) Upholstered furniture, mattresses, materials and other similar products not designed, built and manufactured for outdoor use unless such is in an enclosed porch or balcony.

For purposes of this section an enclosed porch or balcony shall mean a platform located at and attached to or abutting against the entrance to a building, completely covered by a roof and completely enclosed by fully intact glass and/or fully intact screens. Screens are framed wire mesh or framed plastic mesh used to keep out insects and permit airflow.

3333.34 Home occupation.

The purpose of this section is to permit a home occupation as an accessory use if it is compatible with the residential character of the neighborhood in which it is located and is conducted so as not to have an adverse effect upon the average neighbor under normal circumstances; to set standards by which to judge the operation of such use; and to prohibit uses which are incompatible with permissible uses in apartment districts. A home occupation may be an accessory use in any apartment district subject to the following conditions:

- A. Any home occupation use shall be confined to the principal residence of the individual so engaged; shall be excluded from any yard or accessory building; and shall be clearly incidental and subordinate to the primary residential use.
- B. No alteration shall be made in either the internal or external structural form of the residential building or the external appearance for purposes of any home occupation. The removal of partitions or floors, or parts thereof, shall be construed as an alteration of the external or internal structural form and is, therefore, prohibited.
- C. No evidence of any home occupation shall be visible from off the lot where it is conducted except for no more than one home occupation sign displayed in compliance with C.C. 3376.08(B)(1) ~~(6)~~.
- D. No more than 20 percent of the livable area of any residence shall be used for a home occupation.

E. No person other than a permanent resident of the dwelling unit shall be engaged in or employed at any home occupation within such dwelling unit except that in connection with the practice of a profession which can be practiced only with the assistance of supportive personnel, one person not residing in such dwelling unit may be so employed. Profession is limited herein to architect, attorney, clergyman, dentist, engineer, physician or surgeon.

F. No storage of equipment or materials used in a home occupation shall be outside the principal residence.

G. No change shall be made in any utility line, meter or service to accommodate a home occupation and utility use shall not unreasonably exceed that normally or previously used at such residence.

H. No equipment or process shall be used in any home occupation which emits radiation or creates noise, vibration, glare, fumes, odors, or electrical interference detectable to the normal senses off the lot used for such home occupation. In the case of electrical interference, no equipment or process shall be used which creates visual or audible interference.

I. No traffic shall be generated by any home occupation unreasonably greater in volume or different in nature than would otherwise normally occur in the residential neighborhood in which it is located.

J. No wholesale or retail business, including the sale or transfer of any firearm, shall be conducted in a dwelling unit.

3333.35 Private garage.

A private garage in an apartment district shall be so located and constructed as to conform to one or more of the following as the case may require:

(A) A private garage shall not be an accessory use to a lot in an apartment district unless such lot is occupied by a town house, dwelling or apartment house and unless a building permit has been issued for and construction started for same on such lot;

(B) When a private garage is built as an accessory use in a terrace or retaining wall on the front side of the lot, such private garage shall not project in front of the terrace or retaining wall more than three feet, and in no case shall it project above the level of the ground (or main) floor door of a residence on an adjoining lot;

(C) No separate private garage building shall be erected in a terrace or retaining wall, closer than the required building line to the street line, or closer than the minimum side yard requirement or building line to an adjoining lot line. On a corner lot a separate private garage building shall not be closer than the building line of the side street to such side street;

(D) An attached or semi-attached private garage shall have such separation from the town house, dwelling or apartment house as is specified in the Building Code;

(E) A private detached garage shall not occupy more than 45 percent of the total rear yard;

(F) Subject to the limitation of subsection (E) above, no portion of the lot area devoted to a private garage or a carport shall exceed the greater of:

(1) 720 square feet; or

(2) One-third of the minimum net floor area for living quarters of the dwelling unit or units; and

(G) No carport or detached private garage shall exceed 15 feet in height, the perpendicular straight line measured from the curb level, or from the finished grade line of the lot where such grade is higher than the curb, to the highest point of such garage, except that in the university impact district, as defined in Chapter 3325, C.C. 3372.504, in those areas having an architectural review commission as set out in Title 31, C.C., or in a district or listed property, as defined in Chapter 3116, C.C., the 15-foot height limit may be exceeded in order to achieve a compatible roof pitch provided the University Impact District Review Board ~~university area review board~~, the appropriate architectural review commission, or the historic resources commission, as the case may be, finds the increased roof pitch is compatible with the established architectural character of the district and further provided the increased roof pitch does not result in habitable space.

(H) A private garage shall be considered attached to the dwelling only when directly attached to habitable space. Any habitable space in an attached garage must connect directly with habitable space in the dwelling.

(I) Nothing in subsection (H) above shall prevent a breezeway connection between a house and private garage. The area of the breezeway connection shall be utilized in calculating the percent of total rear yard which may be occupied by a private, detached garage as stipulated in subsection (E) above, but shall not be subject to the limitations of subsection (F) above.

(J) No maintenance, alteration, repair, reconditioning or reconstruction of, or connected in any way with, a motor vehicle, as defined by Ohio Revised Code Section 4511.01, registered to anyone other than a resident of the subject premises shall be carried on or conducted in a private garage.

3345.16 Home occupation.

The purpose of this section is to permit a home occupation as an accessory use if it is compatible with the residential character of the neighborhood in which it is located and is conducted so as not to have an adverse effect upon the average neighbor under normal circumstances; to set standards by which to judge the operation of such use; and to prohibit uses which are incompatible with permissible uses in apartment districts. A home occupation may be an accessory use in any planned unit development ~~apartment~~ district subject to the following conditions:

A. Any home occupation use shall be confined to the principal residence of the individual so engaged; shall be excluded from any yard or accessory building; and shall be clearly incidental and subordinate to the primary residential use.

B. No alteration shall be made in either the internal or external structural form of the residential building or the external appearance for purposes of any home occupation. The removal of partitions or floors, or parts thereof, shall be construed as an alteration of the external or internal structural form and is, therefore, prohibited.

C. No evidence of any home occupation shall be visible from off the lot where it is conducted except for no more than one home occupation sign displayed in compliance with C.C. 3376.08(B)(1)-(6).

D. No more than 20 percent of the livable area of any residence shall be used for a home occupation.

E. No person other than a permanent resident of the dwelling unit shall be engaged in or employed at any home occupation within such dwelling unit except that in connection with the practice of a profession which can be practiced only with the assistance of supportive personnel, one person not residing in such dwelling unit may be so employed. Profession is limited herein to architect, attorney, clergyman, dentist, engineer, physician or surgeon.

F. No storage of equipment or materials used in a home occupation shall be outside the principal residence.

G. No change shall be made in any utility line, meter or service to accommodate a home occupation and utility use shall not unreasonably exceed that normally or previously used at such residence.

H. No equipment or process shall be used in any home occupation which emits radiation or creates noise, vibration, glare, fumes, odors, or electrical interference detectable to the normal senses off the lot used for such home occupation. In the case of electrical interference, no equipment or process shall be used which creates visual or audible interference.

I. No traffic shall be generated by any home occupation unreasonably greater in volume or different in nature than would otherwise normally occur in the residential neighborhood in which it is located.

J. No wholesale or retail business, including the sale or transfer of any firearm, shall be conducted in a dwelling unit.

3345.17 Private garages.

A private garage in a residential district shall be so located and constructed as to conform to one or more of the following as the case may require:

- (A) A private garage shall not be an accessory use to a lot in a residential district unless such lot is occupied by a residence or unless a building permit has been issued for and construction started on a residence building on such lot;
- (B) A private garage provided as an accessory use in a PUD district shall not provide for more than two motor vehicles for each family for which such residence is arranged or designed;
- (C) No separate private garage building shall be erected in a terrace or retaining wall, closer than the required building line to the street line, or closer than the minimum side yard requirement or building line to an adjoining lot line. On a corner lot a separate private garage building shall not be closer than the building line of the side street to such side street;
- (D) An attached or semi-attached private garage shall have such separation from the residence or apartment residence as is specified in the Building Code;
- (E) A private detached garage may not occupy more than 45 percent of the total rear yard;
- (F) Subject to the limitation of subsection (E) above, no portion of the lot area devoted to a private garage or a carport shall exceed the greater of:
- (1) 720 square feet, or
 - (2) One-third of the minimum net floor area for living quarters of the principal residence; and
- (G) No carport or detached private garage shall exceed 15 feet in height, the perpendicular straight line measured from the curb level, or from the finished grade line of the lot where such grade is higher than the curb, to the highest point of such garage, except that in the university impact district, as defined in Chapter 3325 , C.C. ~~3372.504~~, in those areas having an architectural review commission as set out in Title 31, C.C., or in a district or listed property, as defined in Chapter 3116, C.C., the 15-foot height limit may be exceeded in order to achieve a compatible roof pitch provided the university area review board, the appropriate architectural review commission, or the historic resources commission, as the case may be, finds the increased roof pitch is compatible with the established architectural character of the district and further provided the increased roof pitch does not result in habitable space.
- (H) A private garage shall be considered attached to the dwelling only when directly attached to habitable space. Any habitable space in an attached garage must connect directly with habitable space in the dwelling.
- (I) Nothing in subsection (H) above shall prevent a breezeway connection between a house and private garage. The area of the breezeway connection shall be utilized in calculating the percent of total rear yard which may be occupied by a private, detached garage as stipulated in subsection (E) above, but shall not be subject to the limitations of subsection (F) above.
- (J) No maintenance, alteration, repair, reconditioning or reconstruction of, or connected in any way with, a motor vehicle, as defined by Ohio Revised Code Section 4511.01, registered to anyone other than a resident of the subject premises shall be carried on or conducted in a private garage.

3347.12 Home occupation.

The purpose of this section is to permit a home occupation as an accessory use if it is compatible with the residential character of the neighborhood in which it is located, and is conducted so as not to have an adverse effect upon the average neighbor under normal circumstances; to set standards by which to judge the operation of such use; and to prohibit uses which are incompatible with permissible uses in apartment districts. A home occupation may be an accessory use in any planned community ~~apartment~~ district subject to the following conditions:

- A. Any home occupation use shall be confined to the principal residence of the individual so engaged, shall be excluded from any yard or accessory building, and shall be clearly incidental and subordinate to the primary residential use.
- B. No alteration shall be made in either the internal or external structural form of the residential building or the external appearance for purposes of any home occupation. The removal of partitions or floors or parts thereof, shall be construed as an alteration of the external or internal structural form and is, therefore, prohibited.

- C. No evidence of any home occupation shall be visible from off the lot where it is conducted except for no more than one home occupation sign displayed in compliance with C.C. 3376.08(B)(1)-(6).
- D. No more than 20 percent of the livable area of any residence shall be used for a home occupation.
- E. No person other than a permanent resident of the dwelling unit shall be engaged in or employed at any home occupation within such dwelling unit except that in connection with the practice of a profession which can be practiced only with the assistance of supportive personnel, one person not residing in such dwelling unit may be so employed. Profession is limited herein to architect, attorney, clergyman, dentist, engineer, physician or surgeon.
- F. No storage of equipment or materials used in a home occupation shall be outside the principal residence.
- G. No change shall be made in any utility line, meter or service to accommodate a home occupation and utility use shall not unreasonably exceed that normally or previously used at such residence.
- H. No equipment or process shall be used in any home occupation which emits radiation or creates noise, vibration, glare, fumes, odors, or electrical interference detectable to the normal senses off the lot used for such home occupation. In the case of electrical interference, no equipment or process shall be used which creates visual or audible interference.
- I. No traffic shall be generated by any home occupation unreasonably greater in volume or different in nature than would otherwise normally occur in the residential neighborhood in which it is located.
- J. No wholesale or retail business, including the sale or transfer of any firearm, shall be conducted in a dwelling unit.

3347.13 Private garages.

A private garage in a residential district shall be so located and constructed as to conform to one or more of the following, as the case may require:

- (A) A private garage shall not be an accessory use to a lot in a residential district unless such lot is occupied by a residence or unless a building permit has been issued and construction started on a residence building on such lot;
- (B) A private garage provided as an accessory use in a planned community district shall not provide for more than two motor vehicles for each family for which such residence is arranged or designed;
- (C) No separate private garage building shall be erected in a terrace or retaining wall, closer than the required building line to the street line, or closer than the minimum side yard requirement or building line to an adjoining lot line. On a corner lot a separate private garage building shall not be closer than the building line of the side street to such side street;
- (D) An attached or semi-attached private garage shall have such separation from the residence or apartment residence as is specified in the Building Code;
- (E) A private detached garage may not occupy more than 45 percent of the total rear yard;
- (F) Subject to the limitation of subsection (E) above, no portion of the lot area devoted to a private garage or a carport shall exceed the greater of:
 - (1) 720 square feet; or
 - (2) One-third of the minimum net floor area for living quarters of the principal residence; and
- (G) No carport or detached private garage shall exceed 15 feet in height, the perpendicular straight line measured from the curb level, or from the finished grade line of the lot where such grade is higher than the curb, to the highest point of such garage, except that in the university impact district, as defined in Chapter 3325, C.C. ~~3372.504~~, in those areas having an architectural review commission as set out in Title 31 C.C., or in a district or listed property, as defined in Chapter 3116, C.C., the 15-foot height limit may be exceeded in order to achieve a compatible roof pitch provided the university area review board, the appropriate architectural review commission, or the historic resources commission, as the case may be, finds the increased roof pitch is compatible with the established architectural character of the district and further provided the increased roof pitch does not result in habitable space.

(H) A private garage shall be considered attached to the dwelling only when directly attached to habitable space. Any habitable space in an attached garage must connect directly with habitable space in the dwelling.

(I) Nothing in subsection (H) above shall prevent a breezeway connection between a house and private garage. The area of the breezeway connection shall be utilized in calculating the percent of total rear yard which may be occupied by a private, detached garage as stipulated in subsection (E) above, but shall not be subject to the limitations of subsection (F) above.

(J) No maintenance, alteration, repair, reconditioning or reconstruction of, or connected in any way with, a motor vehicle, as defined by Ohio Revised Code Section 4511.01, registered to anyone other than a resident of the subject premises shall be carried on or conducted in a private garage.

3363.20 Existing uses.

Existing land uses and buildings which were lawfully in accordance with the zoning regulations of the district where located at the time of passage of Ordinance 966-54, or any amendment thereto, shall be allowed to be continued and shall be governed by the provisions of C.C. Chapter 3391 Sections 3391.01 and 3391.02.

3365.01 M-1 Manufacturing District.

In an M-1 Manufacturing District, the following uses are permitted:

- A. One or more uses as specified in C.C. 3365.02 through 3365.15;
- B. Accessory uses as specified in this chapter; ~~and~~
- C. An adult entertainment establishment and an adult store-; and
- D. Automotive maintenance and repair uses in accordance with Section 3356.07.

All performance standards of this chapter shall apply.

3365.18 Existing uses.

Existing land uses and buildings which were lawfully in accordance with the zoning regulations of the district where located at the time of passage of Ordinance 966-54, or any amendment thereto, shall be allowed to be continued and shall be governed by the provisions of C.C. Chapter 3391 Sections 3391.01 and 3391.02.

3367.01 M-2 manufacturing district.

In a M-2 Manufacturing District, the following uses are permitted:

- A. One or more uses as specified in C.C. 3367.02 through 3367.085-;
- B. All non-residential uses permitted in the C-2 Commercial zoning district and sports training or exhibition facilities-;
- C. Accessory uses as specified in this chapter-; ~~and~~
- D. An adult entertainment establishment and an adult store-; and
- E. Automotive maintenance and repair uses in accordance with Section 3356.07.

3367.11 Existing uses.

Existing land uses and buildings which were lawfully in accordance with the zoning regulations of the district where located at the time of passage of Ordinance 966-54, or any amendment thereto, shall be allowed to be continued and shall be governed by the provisions of C.C. Chapter 3391 Sections 3391.01 and 3391.02.

3367.31 Day care center ~~and school~~ standards.

An adult or child day care center shall require a transportation plan, which shall be submitted as part of a zoning clearance application. The plan shall include a written and visual description of the loading and unloading, parking and traffic circulation areas. The director of the department of public service or designee shall review the transportation plan, and may modify or deny the plan for safety reasons.

3372.602 Overlay areas.

The boundaries of designated Urban Commercial Overlay areas are part of the Official Zoning Map and described in separate sections beginning with Section 3372.650 and ending with Section 3372.699. For the purposes and requirements of an Urban Commercial Overlay area, the term "primary street" means Third Avenue, Fourth Street, Fifth Avenue, Broad Street, Cleveland Avenue, Front Street, Grandview Avenue, Indianola Avenue, High Street, King Avenue, Livingston Avenue, Lockbourne Road, Long Street, Main Street, Mt. Vernon Avenue, Northwest Boulevard, Oakland Park Avenue, Parsons Avenue, Sullivant Avenue, Summit Street, and Whittier Street.

3375.01 Scope and definitions.

Chapters 3375 to 3383, C.C. inclusive, hereinafter called the "Graphics Code," are established to regulate private graphics within the city. Within the city, no person shall construct, install, relocate, alter, maintain or remove a graphic regulated by this Graphics Code unless done in accordance with this Graphics Code.

Chapter 902, C.C., in part, prohibits the display or any other utilization of a private graphic within any public right-of-way. It is not within the scope of this Graphics Code to authorize any graphic to be situated entirely within any public right-of-way.

A graphic attached to a building or other approved structural support situated on a lot of record, may extend over a public right-of-way when installed and maintained in conformance with the provisions of this Graphics Code. No property right shall be conveyed to any person, including but not limited to an owner or occupant, upon the granting of a permit allowing a graphic to extend into any public right-of-way. No interest shall be conveyed other than a temporary interest in the airspace, which shall be subservient to the interests of the city or other applicable governmental body.

In addition, it is not the intent of this Graphics Code to repeal, abrogate, ~~annul annual~~, or in any way impair or interfere with provisions of other laws or codes, except those specifically repealed by this Graphics Code. However, where this Graphics Code imposes greater restrictions, the provisions of this Graphics Code shall prevail.

This Graphics Code distinguishes between graphics and signs as defined in Chapter 3303, C.C. A "sign" is a type of "graphic," therefore the term "graphic" shall include the term "sign." A reference to the term "sign" shall not apply to other types of "graphics."

For the purposes of this Graphics Code the terms, phrases, words, and their derivatives use herein shall have the meaning given them in Chapter 3303, C.C.

The definitions of Chapter 3116, C.C. and Chapter 4101, C.C. shall also apply, except where a conflict occurs, Chapter 3303 C.C. takes precedence. Where not inconsistent with the context, words used in the present tense include the future, words in the plural number include the singular number, and words in the singular include the plural number.

3377.08 Illumination and special effects.

A great deal of the character of an activity, street, place, neighborhood, or community is expressed by the effect of illumination and other special features of signs. It is the intent of this Graphics Code to allow for the utilization of special effects and their potential contribution to the visual character of a place.

The following provisions shall apply to special effects in institutional, commercial and manufacturing districts:

A. Sign Illumination.

1. A sign illuminated directly, indirectly, internally or by neon tubes bent in the form of letters or shapes is permitted for any use or activity, unless specifically prohibited by other provisions of this Graphics Code.
2. External illumination for a permanent on-premises sign displayed in zoning districts AR-O, I₁ and C-2 shall be limited to white light. The background of such internally illuminated sign shall be opaque.

3. The color of illumination and background opacity shall not be restricted for any other permanent on-premises sign displayed in a commercial and manufacturing district.
4. The light source, including fixture, of any sign utilizing external illumination shall be shielded from view from any public right-of-way and from any residential dwelling unit.
5. Flashing signs and bare bulb lamp illumination shall be permitted only in zoning districts C-3, C-4, C-5, and M. Each ~~bulb~~ lamp in a flashing sign shall not exceed ~~fifteen (15) watts~~ a luminance of 110 lumens. Non-flashing signs may use bare ~~bulb~~ lamp illumination, but any one (1) ~~bulb~~ lamp shall not exceed ~~thirty (30) watts~~ a luminance of 215 lumens. Internal or external reflectors shall not be used in conjunction with bare ~~bulb~~ lamp illumination.
6. The use of open flame as a source of illumination shall be permitted only in the C-4, Commercial District.

B. Changeable Copy Signs.

1. A manual changeable copy sign may be utilized in any zoning district covered by the Tables of Elements; however, an automatic changeable copy sign shall be permitted only in zoning districts C-3, C-4, C-5, and M.
2. At least 50 percent of the graphic area of a ground sign or projecting sign which utilizes changeable copy shall be non-changeable copy used for identification of the use which it serves.
3. A changeable copy sign shall not be permitted within any public right-of-way, except that a changeable copy wall sign extending no more than six inches into the right-of-way may be utilized.
4. A sign utilizing a copy change procedure shall display each individual message a minimum of eight (8) seconds.
5. The images and messages displayed must be static, and the transition from one static display to another must be instantaneous to the human eye without any transition effects. Transition effects include wipes, fades, or other special effects.
6. Each automatic changeable copy sign shall be equipped with a light sensing device that automatically adjusts the brightness of the sign as ambient light conditions change.
7. Each automatic changeable copy sign shall be operated with monitoring and methods in place that shall either turn off the display, or show a full black image on the display, in the event of a malfunction that affects more than fifty (50) percent of the sign face.
8. No automatic changeable copy sign shall exceed a brightness level of 0.3 foot-candles above ambient light as measured using a foot-candle (Lux) meter at a pre-set distance in accordance with the following procedure:
 - a. At least 30 minutes past sunset, record the ambient light while the sign is off or displaying all black copy, or with the sign's illumination blocked.
 - b. The light meter shall be held five feet above the finished grade in front of the sign.
 - c. The meter shall be aimed toward the center of the automatic changeable copy sign.
 - d. From the same location, a second reading shall be recorded while the sign is on and not blocked.
9. If the difference between the measurements is 0.3 foot candles or less, the brightness is properly adjusted; otherwise, the billboard must be adjusted to comply with the brightness adjustment standard set forth above.
10. The measurement distance shall be determined as shown in Table 1, which is derived and generalized from the formula shown for 180 square feet in the table; (the square root of) (the automatic changeable copy area times 100):

Table 1. Distances from which to measure the brightness of on-premises automatic changeable copy graphics.

Area of automatic changeable copy in square feet	Measurement distance in linear feet
---	--

10	32
20	45
30	55
40	63
50	71
60	77
70	84
80	89
90	95
100	100
120	110
140	118
160	126
180 x 100 = 18000; $\sqrt{18000} = 134$	134
200	141
220	148
240	155
260	161
280	167
300	173
350	187
400	200
450	212
500	224
550	234
600	245
650 and greater	254

11. Existing automatic changeable copy signs exception. An automatic changeable copy sign, which was lawfully established with no dimming capability, shall be considered a nonconforming graphic regarding the requirement for dimming control technology in section 3377.08(C)(6).

C. Mechanical Movement.

1. A sign that physically revolves or moves up, down, or sideways; or any sign that contains mechanical movement or gives the appearance of movement through animation within the copy area shall be displayed only in zoning districts C-3, C-4, C-5, and M.
2. A revolving sign shall be limited to a maximum of eight revolutions per minute.

3377.24 Wall signs for individual uses.

A. An individual use or activity ~~which has a public entrance~~ on a building facade facing an abutting street, may display one wall sign, comprised of one or more elements, and/or permanent window signs on that facade in accordance with the Tables of Elements.

B. An individual use or activity which has a public entrance on a building face that is not oriented to a street abutting the lot, may display wall signs and/or permanent window signs on that facade in accordance with following setbacks and mass factors:

Setback	Mass Factor
0—100 Feet	1
101—300 Feet	2

301—500 Feet	3
over 500 Feet	4

For this purpose, the setback is the perpendicular distance measured from the building wall that will support the sign to the nearest property line of the subject lot, regardless of other referents.

C. Where the portion of the building being occupied does not include a wall facing a street which abuts the lot, such as, but not limited to, multiple-tenant office buildings, the use or activity may display one wall sign which shall not exceed ten square feet in area. Such sign shall be located adjacent to a pedestrian entrance to the building or adjacent to a driveway providing access to on-site parking.

D. Each use or tenant shall display no more than one additional permanent on-premises wall sign on the side or rear of the subject building. Such sign shall not exceed 16 square feet in area and shall be static at all times and illuminated only during the hours which the activity is operating.

3380.102 I-670 area of special graphics control.

A. Purpose. The I-670 area of special control is established and the regulations therefore are enacted to conform to and implement I-670 corridor development plan guidelines, adopted by Ordinance 40-89, in achieving two of the plan's objectives:

1. Development opportunities that enhance the I-670 corridor community, both physically and through the creation of jobs and business-ownership opportunities for the residents; and
2. An attractive greenbelt/entryway to the downtown from the airport.

B. Establishment. Portions of the I-670 corridor as hereinafter set forth are hereby established as an area of special graphics control. The I-670 area of special graphics control shall include the John Glenn Port Columbus International Airport property and extend 2,000 feet perpendicularly from the outermost edges of the public right-of-way and in all directions at the termini of each of the following sections of the area:

1. Interstate-670: Being the Interstate-670 portion of the Interstate System lying between Interstate-270 (I-270) in the northeast quadrant of Columbus and High Street in the downtown including the northern and southern loops at Interstate-71 (I-71) and being altogether referred to herein as I-670.
2. I-670 Entrance and Exit Ramps: Being all limited access ramps entering and exiting I-670 as described in (1) above.
3. Airport Connector Boulevard: Being all limited access street and ramps connecting Stelzer Road and Cassady Avenue and providing a north and south entrance and exit to and from I-670 at John Glenn Port Columbus International Airport.
4. Stelzer Road: Being that portion of the Stelzer Road lying between I-670 on the north and Eleventh Avenue on the south.

The I-670 area of ~~if~~ special graphics control shall be composed of Parts 1 and 2 each with different levels of regulation. The John Glenn Port Columbus International Airport property and 1,000 feet abutting the public rights-of-way as set forth in subsection (B)(1), (2), (3) and (4) of this section shall constitute Part 1. One thousand feet abutting that portion of Part 1 that applies to I-670, the I-670 entrance and exit ramps, the Airport Connector Boulevard and Stelzer Road as set forth in subsection (B)(1), (2), (3) and (4) of this section shall constitute Part 2.

C. Intent. The establishment of the I-670 area of special graphics control and the prohibition of billboards therein is intended to:

1. Create and maintain an attractive greenbelt/entryway from John Glenn Port Columbus International Airport to the downtown;
2. Provide for appropriate accessory signs for the identification and encouragement of economic development in the I-670 corridor;
3. Discourage excessive visual competition and clutter that result from a proliferation of billboards;
4. Promote the public convenience, comfort, prosperity and general welfare;

5. Increase the attractiveness of the I-670 corridor to businesses, residents, visitors and tourists thereby promoting the area's economy;
6. Protect the public investment in the highway; and
7. Promote traffic safety by reducing distractions to drivers.

D. Controls. No person shall erect a billboard or supporting structure therefore within Part 1 of the I-670 ~~area are~~ of special graphics control, as set forth in subsection (B) above.

No person shall erect a billboard or supporting structure therefore within Part 2 of the I-670 area of special graphics control, facing forward or designed or situated so as to be perceived at any time by the operator of a motor vehicle proceeding in any lawful direction within the rights-of-way of I-670, I-670 entrance and exit ramps, Airport Connector Boulevard or Stelzer Road as defined in subsection (B) above.

E. Applicability. No provision of this section shall be construed to permit a billboard in any zoning district of location contrary to another provision of the Zoning Code or this Graphics Code. This section is not intended to repeal any other Zoning Code or Graphics Code billboard regulation with is not in conflict herewith.

3384.01 Purpose.

The AEO-airport environs overlay district is hereby established to protect the public health, safety and welfare by regulating development and land use within airport environs and airport hazard areas; to ensure compatibility between John Glenn Port Columbus International Airport, Bolton Field Airport, the Ohio State University Airport (a/k/a Don Scott Field), and any future airport and surrounding land uses; and to protect said airports from incompatible encroachment.

Airport hazards within the AEO-airport environs overlay district are hereby declared a public nuisance. Within the AEO-airport environs overlay district and its three subdistricts airport standards and requirements shall apply to each property in addition to the standards and requirements of the underlying zoning district. In case of conflicting standards and requirements, the more stringent standards and requirements shall apply.

3384.021 Airport.

"Airport" means any airfield located within the corporate limits of the city, owned and operated by the city or other governmental agency, and subject to Ldn contours approved by the Federal Aviation Administration, presently including, but in the future may not be limited to, John Glenn Port Columbus International Airport, Bolton Field Airport, and Ohio State University Airport (a/k/a Don Scott Field).

3384.03 Boundaries of overlay.

The AEO-Airport Environs Overlay District shall contain all airport environs for John Glenn Port Columbus International Airport, Bolton Field, the Ohio State University Airport, and any future airport as defined in this chapter.

The AEO-Airport Environs Overlay District is subdivided into three subdistricts which represent different levels of noise impact. The geographic location of these noise zone subdistricts shall be indicated on the zoning map, as per the requirements of this Zoning Code, as follows:

- (a) Subdistrict A, which shall include the area within the 65 Ldn to 70 Ldn noise exposure area,
- (b) Subdistrict B, which shall include the area within the 70 Ldn to 75 Ldn noise exposure area.
- (c) Subdistrict C, which shall include the area within the 75 Ldn and greater noise exposure area.

The boundaries of the AEO-Airport Environs Overlay District and its subdistricts, as adopted herein, shall be reviewed and amended as appropriate whenever the operating authority of an airport certifies its update or amendment of the noise contour maps and/or the FAR Part 150 Noise Compatibility Program to the Director with a copy thereof.

Copies of the appropriate noise contour map and FAR Part 150 Noise Compatibility Study shall be on file and open to public inspection in offices of John Glen Columbus International Airport, Bolton

Field Airport, Ohio State University Airport, and any future airport as defined in this chapter. Copies of all appropriate noise contour maps also shall be on file and open to public inspection in the Department.

3392.13 Inspections.

The Director shall cause any junk yard, salvage yard, or impound lot to be inspected to determine compliance with this Code at any time deemed appropriate. The Director shall initiate the annual inspection for license renewal at a time which will provide for the operator's compliance with any orders prior to the license expiration.

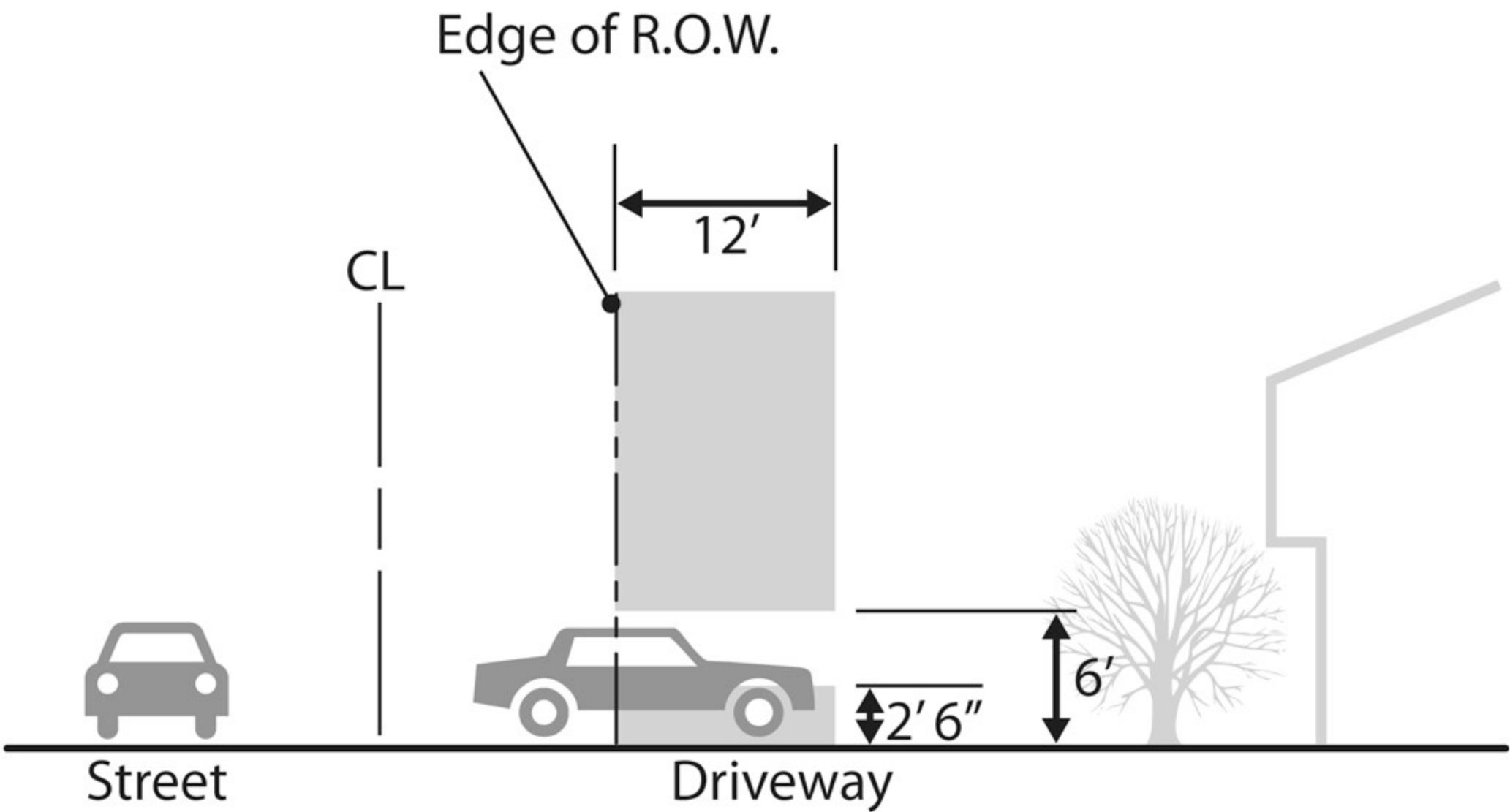

Street

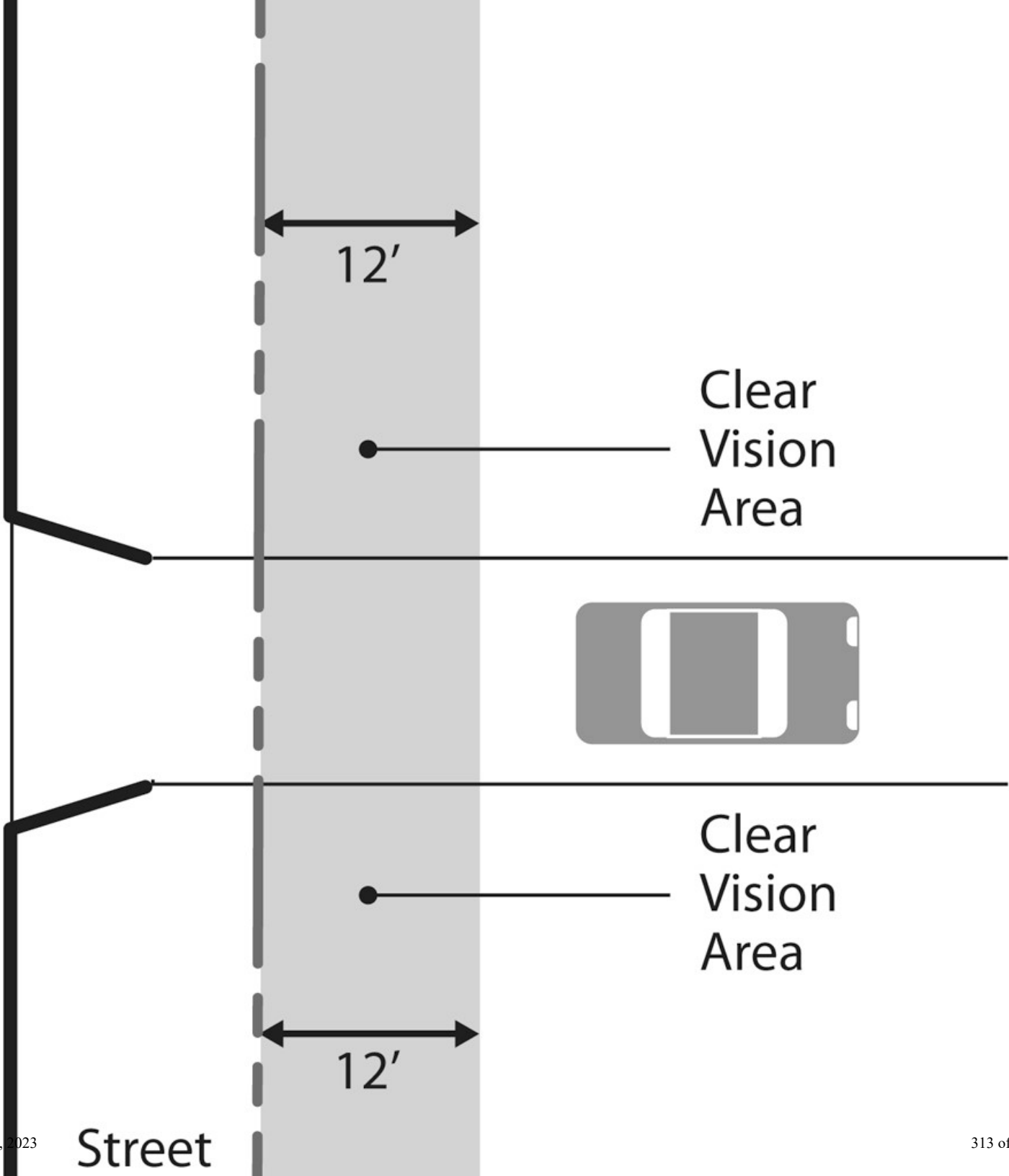

12'

Clear
Vision
Area



Clear
Vision
Area

12'

Street

Vision Clearance Triangle

Unobstructed vision between 2½ and 10 feet

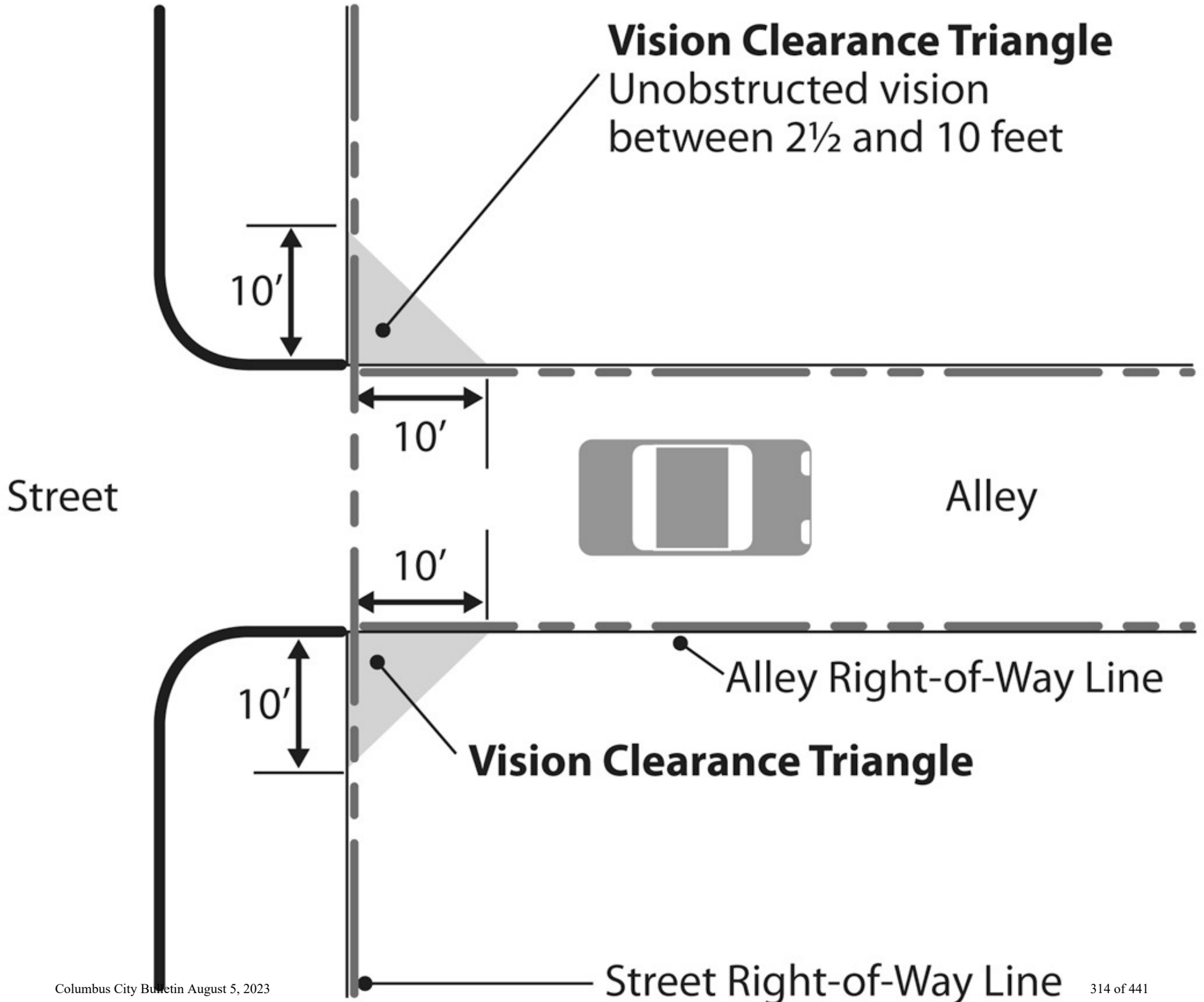

Street



Clear Vision Triangle
No fence, wall, planting or other obstruction shall exceed 2½ feet in height above the centerline grade of adjacent streets

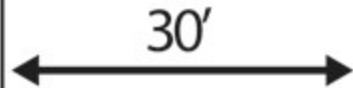

Street

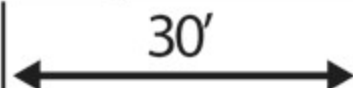

Clear Vision Triangle

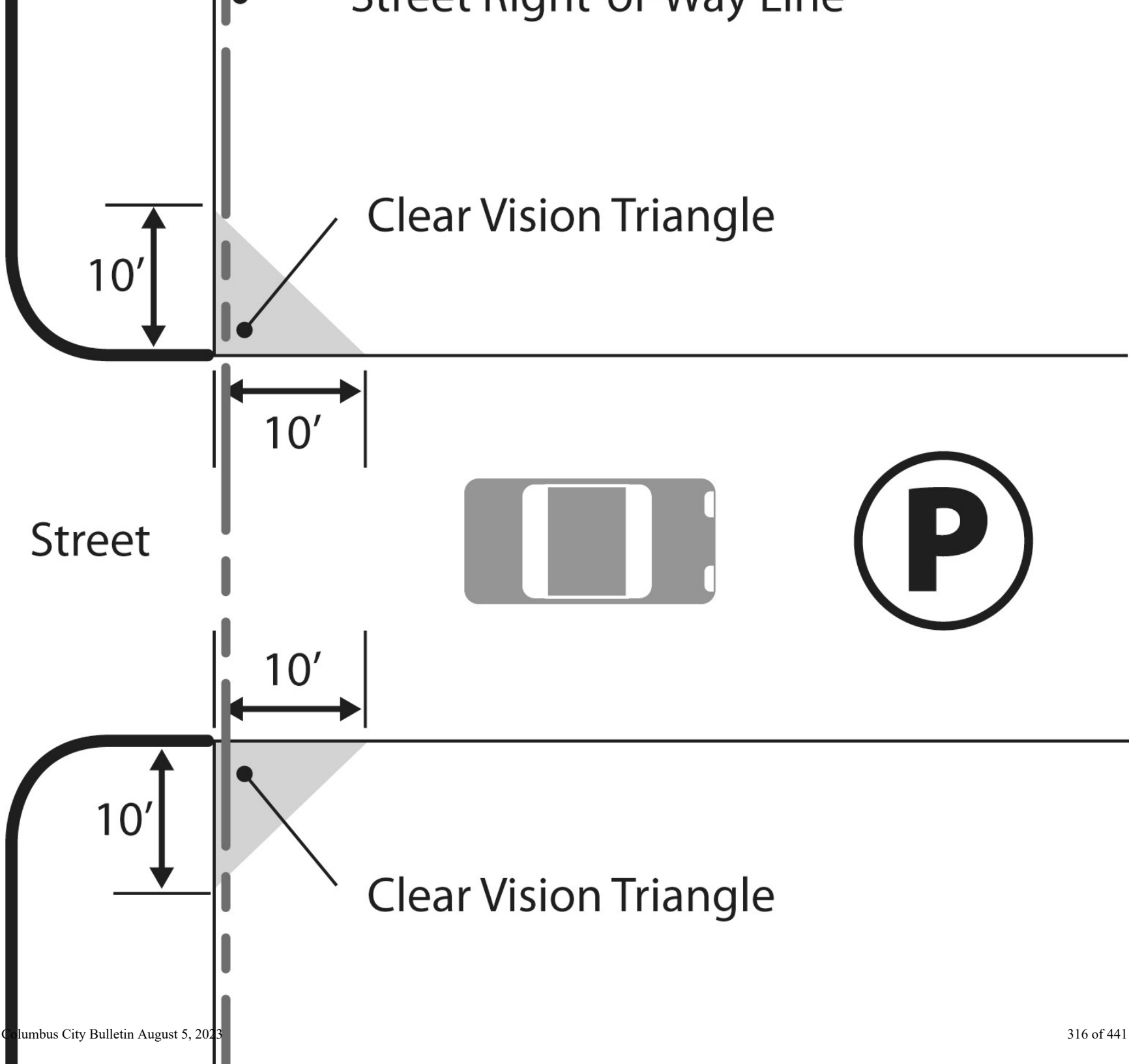

10'

Clear Vision Triangle

10'

Street

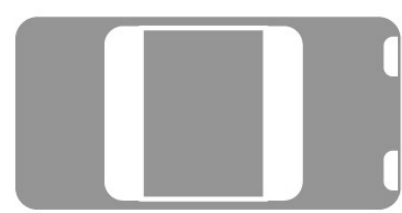

10'

10'

Clear Vision Triangle

EXHIBIT A to Ordinance Number 1872-2023

3312.01 Purpose.

The purpose of this chapter is to regulate ~~land use for~~ parking, loading and maneuvering; to ~~ensure~~ assure the provision of ~~at least the minimum~~ the appropriate number of off-street parking spaces for each use; to enact standards for parking, stacking, and loading; to assure maintenance of existing parking; and to prohibit inappropriate parking. These standards are designed to provide for the parking and loading needs of occupants, customers, visitors or others involved in the use or occupancy of any building or parking lot; to balance needs associated with different transportation modes, including automobile, pedestrian, transit and bicycle; ensure that off-street parking, loading, stacking and access demands will not adversely affect other nearby land uses and surrounding neighborhoods; require appropriate landscaping and buffering of off-street parking lots for pedestrian safety and traffic separation, visually break up large expanses of pavement, visually screen off-street parking lots, loading and stacking areas; and encourage the incorporation of environmentally sustainable design elements; all to enhance convenience and to protect the public health, safety and general welfare.

This chapter regulates parking, stacking, and loading designed for either principal or accessory uses. The standards in this chapter are those that will be reviewed by the director before issuing a certificate of zoning clearance. Other parking or parking lot requirements may be regulated by the Department of Public Service and the Department of Public Utilities.

3312.03 Administrative requirements.

A. Each owner of real property shall provide and continue to provide parking in compliance with code provisions in effect at the time such particular use commenced.

B. Any person who initiates a new use, changes the intensity of, or expands an existing use on any lot shall provide off-street parking, stacking, loading and maneuvering in compliance with this chapter. For purposes of this chapter, "existing" means legally established prior to change or expansion and includes "former"; and "new" means subsequent to change or expansion and includes "proposed."

C. The minimum and maximum number of parking, stacking and loading spaces required for a particular use is specified in this chapter. Exceptions to these ~~minimum~~ requirements are as follows:

1. Special Parking Areas. A lot which lies within a special parking area shall be subject to specifications for that area.
2. Initiating a New Use, Changing the Intensity of or Expanding an Existing Use. A use of higher intensity requires more parking spaces than does a use of lower intensity. For purposes of comparison, "intensity" means the minimum requirements for parking spaces generated by a particular use. Any person who initiates a new use, or changes the intensity of, or expands an existing use, shall provide the number of parking spaces required by such use as set forth in this code or as required by rule or regulation, calculated as specified in items (a) through ~~(f)~~(g).
 - a. Without expansion of an existing building, a new use of intensity equal to or lower than the existing use shall provide the required parking for the new use or, at the minimum, maintain the existing number of parking spaces; no additional parking spaces shall be required.

Example:

Existing medical office to new law office

Required spaces for existing medical office = 10

Required spaces for new law office = 7

Existing spaces = 5

Total parking spaces required for new use = 5

b. With expansion of an existing building, a new use of intensity equal to or lower than the existing use shall provide the same number of parking spaces as the existing number of parking spaces, plus the additional parking spaces required for the expansion.

Example:

Existing medical office to new law office

Required spaces for existing medical office = 10

Required spaces for new law office = 7

Existing spaces = 5

Spaces required for building expansion = 4

Existing parking spaces = 5

Total required for new use $(4 + 5) = 9$

c. Without expansion of an existing building, a new use of higher intensity than the existing use shall provide the same number of parking spaces as the existing use, plus additional parking spaces equal to the difference between that required for the higher and lower intensity uses.

Example:

Existing retail store to new restaurant

Required spaces for existing retail store = 8

Required spaces for new restaurant = 27

Existing spaces = 5

Difference between intensities $(27 - 8) = 19$

Total parking spaces required for new use $(5 + 19) = 24$

d. With expansion of an existing building where the number of existing parking spaces is less than the number required for the existing use and is also less than that required for the new use, a new use of higher intensity than the existing use shall provide the same number of parking spaces as the existing use, plus additional parking spaces equal to the difference between that required for the higher and lower intensity uses, plus that number required for the expansion.

Example:

Existing retail store to new restaurant

Required spaces for existing retail store = 8

Required spaces for new restaurant = 27

Existing spaces = 5

Spaces required for building expansion = 12

Difference between intensities $(27 - 8) = 19$

Total parking spaces required for new use $(5 + 12 + 19) = 36$

e. With expansion of an existing building where the number of existing parking spaces is less than that required for the existing use but is more than that required for the new use, a new use shall provide the number of parking spaces required for the new use plus that required for the expansion.

Example:

Existing medical office to new law office

Required spaces for existing medical office = 10

Required spaces for new law office = 7

Existing spaces = 9

Spaces required for building expansion = 4

Total parking spaces required for new use $(7 + 4) = 11$

f. With expansion of an existing building where the number of existing parking spaces exceeds both that required for the existing use and that required for the new use, a new use shall provide the number of parking spaces required for the new use plus that required for the expansion.

Example:

Existing retail store to new restaurant

Required spaces for existing retail store = 8

Required spaces for new restaurant = 27

Existing spaces = 29

Spaces required for building expansion = 12

Total parking spaces required for new use (27 + 12) = 39

g. Without expansion of an existing building where the number of existing parking spaces exceeds the maximum number of allowable parking spaces for the new use, the maximum for the new use shall be equal to the existing number of parking spaces.

Example:

Existing retail store to new law office

Required spaces for existing retail store = 20 min. and 25 max.

Required spaces for new law office = 12 min. and 20 max.

Existing spaces = 28

Maximum for the new use = existing spaces = 28

D. Parking spaces shall be provided on the same lot as the use they are intended to serve with the following exceptions: For a commercial, institutional or manufacturing use, the parking may be provided on a lot that is:

1. Located within 750 feet of the use to be served; and
2. Owned or leased by the operator of the commercial, institutional, or manufacturing use and located in an appropriate zoning district with a limited overlay or CPD text having conditions which limit its use to parking reserved for the duration of that use to be served.

E. Revision of an approved parking lot; including, but not limited to reduction, enlargement, restriping or remarking of any parking lot in a manner that differs from the existing site plan; shall require a new site plan and a certificate of zoning clearance prior to such change.

F. Off-street parking and loading spaces required for any use not specifically listed herein shall be the same as that required for a similar type use as determined by the director.

G. A parking lot comprised of parcels within different taxing districts which cannot be combined shall be deemed one lot, subject to the minimum overall dimensions of aisles, drive-up stacking areas, driveways, parking spaces, and loading spaces being provided. The required parking shall be calculated for the overall development and not for each individual parcel and all parcels shall be covered by the same zoning clearance.

3312.051 Short North Special Parking Area

A. The Short North Special Parking Area is that area indicated on the official city zoning map and bounded as follows:

On the north by the centerline of Fifth Avenue, on the east by the centerline of the first set of railroad tracks east of North Fourth Street, on the south by the centerline of Interstate 670, and on the west by the centerline of first alley or street east of Neil Avenue, said western boundary being more particularly described, following centerlines, as follows:

Beginning at the intersection of Hunter Avenue and West Goodale Street;

Thence northerly along Hunter Avenue to West Poplar Avenue;

Thence westerly along West Poplar Avenue to the first alley east of Neil Avenue;

Thence northerly along the first alley east of Neil Avenue to Collins Avenue;

Thence easterly along Collins Avenue to Highland Street;

Thence northerly along Highland Street to Division Alley;

Thence westerly and northerly along Division Alley to West Second Avenue;

Thence westerly along West Second Avenue to Sunside Alley;

Thence northerly along Sunside Alley to West Third Avenue,

Thence westerly along West Third Avenue to Sunside Alley,

Thence northerly along Sunside Alley to the first nameless alley south of West Fourth Avenue;

Thence westerly and northerly along the first nameless alley south of West Fourth Avenue to West Fourth Avenue;

Thence westerly along West Fourth Avenue to Forsythe Avenue;

Thence northerly along Forsythe Avenue to West Fifth Avenue.

B. Non-residential, off-street vehicle parking requirements in the Short North Special Parking area shall be One-Half (1/2) of the off-street parking as required in this chapter, except as follows:

Art Gallery - No off-street parking shall be required;

Extended Stay Hotel - 1 space per unit;

Retail, Office, and Medical Office Uses, 2,500 square feet or less - No off-street parking shall be required;

Two-, Three-, and Multi-Unit Dwellings - 1 per unit;

Single-Unit Dwellings - No off-street parking shall be required for single-unit dwellings when located as a single unit on its own parcel that was subdivided prior to the effective date of this ordinance. For single-unit dwellings that do not meet the requirements in the preceding sentence, 1 space per unit shall be required.

No other off-street parking reductions, including any provided by any commercial overlay, shall apply.

Loading spaces and any required bicycle parking shall be as required in this chapter.

Where there is no feasible means to locate bicycle parking spaces in a usable location on the subject parcel, the bicycle parking requirement may be satisfied by payment of a fee in lieu of providing the required bicycle parking spaces, as determined by the Department of Public Service Director of Public Service, or designee.

In the Short North Special Parking area, no further reduction or variance to the number of required off-street parking spaces shall be granted by a variance by the Board of Zoning Adjustment or City Council.

C. The Director of the Department of Public Service shall promulgate rules and regulations for the administration of the Short North Special Parking Area and shall have the authority to collect a fee in lieu of providing the required number of off-street vehicle and bicycle parking spaces as set out in these rules and regulations.

D. Upon the submission of an application for zoning clearance, the Director of the Department of Public Service, or designee, shall determine the cost of the payment in lieu of providing the required number of off-street vehicle and bicycle parking spaces in the Short North Special Parking area.

E. Payments shall be dedicated for the establishment, operation, and maintenance of facilities and programs to address and/or mitigate parking demands and deficiencies within the boundaries of the Short North Special Parking Area.

3312.053 East Franklinton Special Parking Area

A. The East Franklinton Special Parking Area is that area indicated on the official city zoning map and bounded as follows:

Beginning at the point where the eastern right-of-way boundary of State Route 315 intersects with the northern right-of-way boundary of I-70;

Thence easterly to the intersection of the northern right-of-way boundary of I-70 and the northern bank of the Scioto River;

Thence easterly along the northern bank of the Scioto River to its intersection with the western boundary of the Downtown District;

Thence northerly along the western boundary of the Downtown District;

Thence westerly along the southern boundary of the Downtown District until it intersects with the eastern boundary of State Route 315;

Thence southerly until the place of the beginning.

B. Non-residential, off-street vehicle parking requirements in the East Franklinton Special Parking Area shall be One-Half (1/2) of the off-street parking as required in this chapter, except as follows:

- Art Gallery - No off-street parking shall be required;
- Eating and Drinking Establishment without a pickup unit, 1,500 square feet or less - No off-street parking shall be required;
- Retail, Office, and Medical Office, 2,500 square feet or less - No off-street parking shall be required
- Extended Stay Hotel - 1 space per unit;
- Single-Unit Dwellings - No off-street parking shall be required for single-unit dwellings when located as a single unit on its own parcel that was subdivided prior to the effective date of this ordinance. For single-unit dwellings that do not meet the requirements in the preceding sentence, 1 space per unit shall be required;
- Two-Unit Dwelling - 1 Space
- Three-Unit Dwelling - 2 Spaces.
- Four-Unit Dwelling - 3 Spaces
- Multi-Unit Dwellings above Four-Units - 1 space per dwelling unit.

No other off-street parking reductions, including any provided by any commercial overlay, shall apply.

C. Loading spaces and any required bicycle parking shall be as required in this chapter. Where there is no feasible means to locate bicycle parking spaces in a usable location on the subject parcel, the bicycle parking requirement may be satisfied by payment of a fee in lieu of providing the required bicycle parking spaces, as determined by the Department of Public Service Director of Public Service, or designee.

D. In the East Franklinton Special Parking Area, no further reduction or variance to the number of required off-street parking spaces shall be granted by the East Franklinton Review Board, the Board of Zoning Adjustment or City Council.

E. The Director of the Department of Public Service shall promulgate rules and regulations for the administration of the East Franklinton Special Parking Area and shall have the authority to collect a fee in lieu of providing the required number of off-street vehicle and bicycle parking spaces as set out in these rules and regulations.

F. Upon the submission of an application for zoning clearance, the Director of the Department of Public Service, or ~~his or her~~ designee, shall determine the cost of the fee in lieu of providing the required number of off-street vehicle and bicycle parking spaces in the East Franklinton Special Parking Area.

G. Fees in lieu shall be dedicated for the establishment, operation, and maintenance of facilities and programs to address and/or mitigate parking demands and deficiencies within the boundaries of the East Franklinton Special Parking Area.

3312.07 Downtown special parking area.

Downtown parking shall be as prescribed in the downtown district zoning chapter.

~~Parking lot design standards.~~

3312.09 Aisle.

An aisle is that portion of the circulation area within a parking lot, excluding the driveway, which provides accessibility to parking, stacking or loading spaces.

An aisle to serve adjacent loading spaces shall have a minimum width of 15 feet. No part of the loading space may be included in this calculation.

The minimum width permissible for an aisle to serve adjacent parking spaces shall depend on the smallest angle of parking as measured between the centerline of the aisle and the centerline of the adjacent parking space as illustrated in the figures below:

Figure 1. Angle of a parking space.

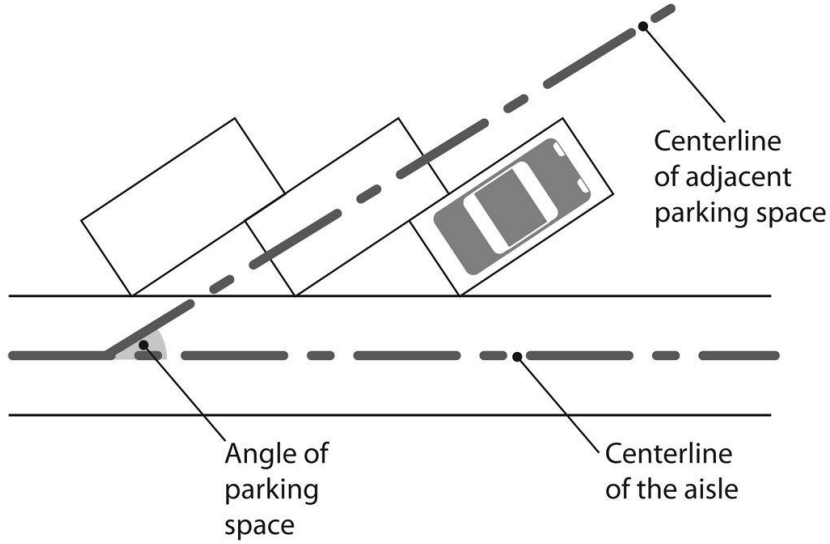

Figure 2. Table of parking angles.

Angle of parking	Minimum aisle width	Figure
80° or more	20 feet - two way travel	2a
Less than 80° but 50° or more	17 feet - one way travel	2b
Less than 50°	13 feet - one way travel	2c, 2d
0° or parallel parking	13 feet - one way travel	2e
0° or parallel parking	20 feet - two way travel	2e

Figure 2a. Angle of parking 80° or more

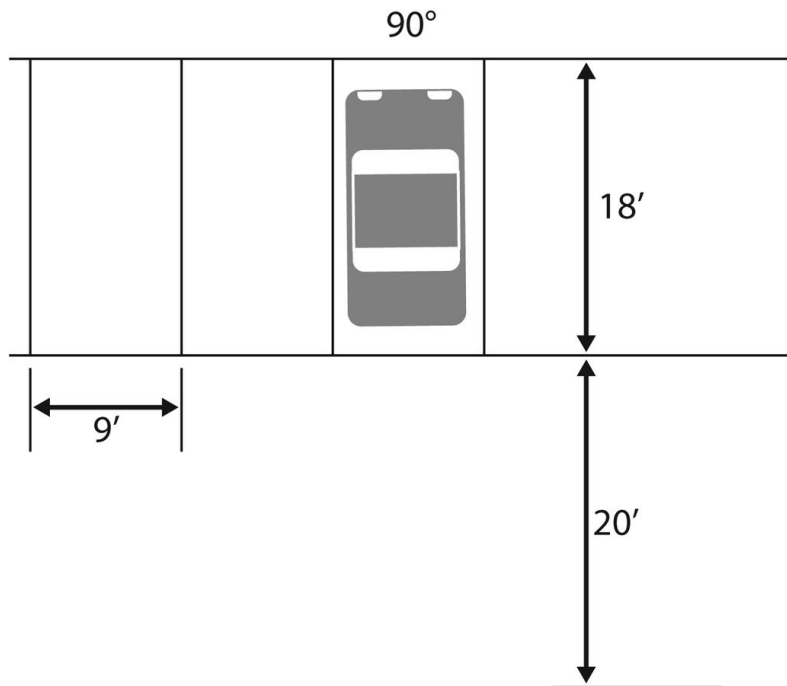

Figure 2b. Angle of parking less than 80° but 50° or more

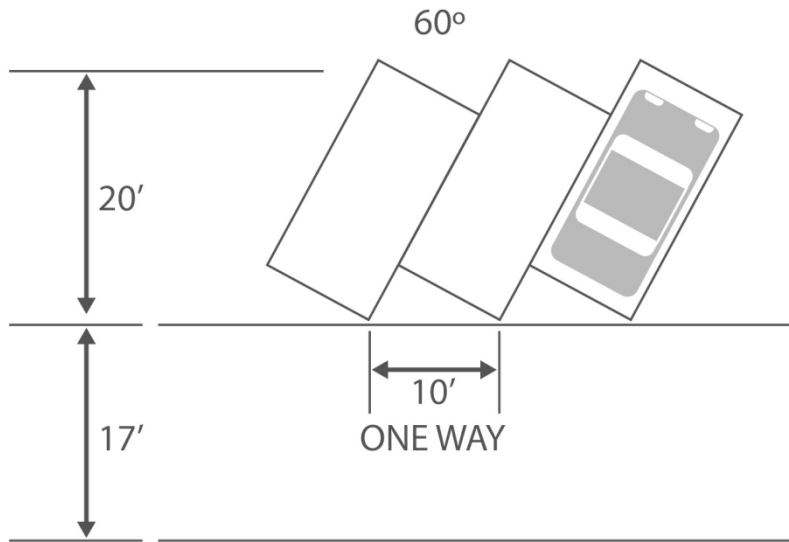

Figure 2c. Angle of parking less than 50° but 30° or more

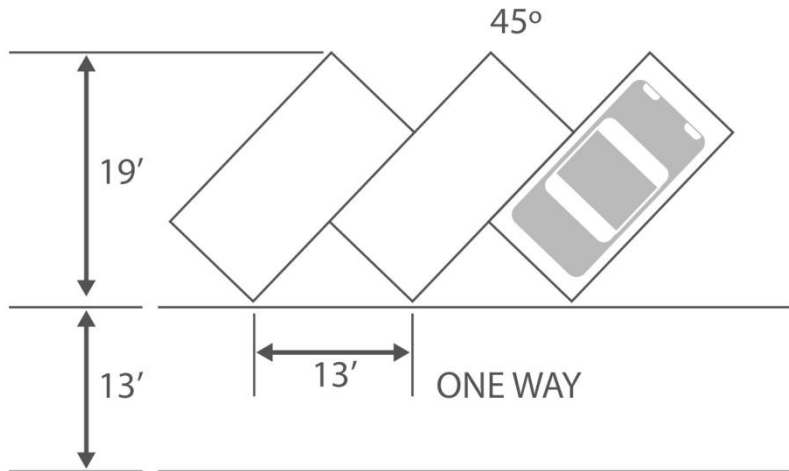

Figure 2d. Angle of parking less than 30° but 0° or more

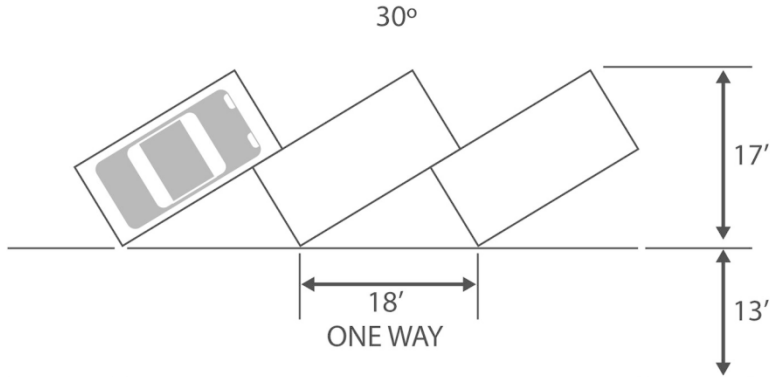
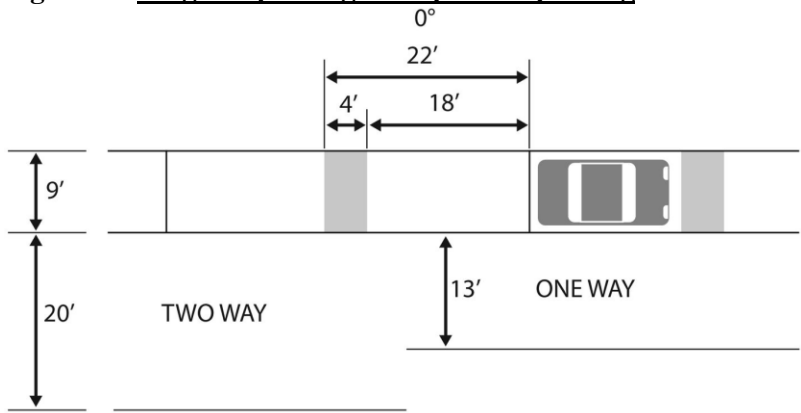

Figure 2e. Angle of parking 0° or parallel parking



3312.11 Drive-up stacking area.

Any use having drive-up service shall provide a motor vehicle stacking area on-site to minimize off-site traffic congestion while waiting for service.

For each drive-up unit associated with a use, an owner shall provide stacking spaces, each the size of a regular automobile parking space. The area required for these four to 25 stacking spaces is exclusive of any required parking space, loading space, driveway, aisle or required yard and is dependent on the total number of drive-up units as follows:

Drive up Stacking Space Requirements Table					
Land use	Total <u>minimum</u> number of stacking spaces required				
	1 unit	2 units	3 units	4 units	5 or more
Restaurants <u>Eating and drinking establishments, drive-through retail establishments beverage stores, and automatic car washes</u>	8	12	18	23	25
Self-service car wash	2	4	6	8	10
Bank with drive-up teller service	6	9	13	17	19
Other uses and automatic teller machines	4	6	9	12	13

Sites with stacking shall include at least one exclusive by-pass lane with a minimum width of ten feet or include an aisle, driveway or other circulation area in the parking lot design to allow vehicles to by-pass the stacking area. For sites that utilize an order station in advance of a drive-up unit, a minimum of 50% of the required stacking spaces shall be provided in advance of the order station. The provisions of the sentence above shall not prohibit additional stacking spaces beyond the minimum requirement being provided between the order station and drive-up unit. A drive-up unit may project up to one foot into the stacking area.

3312.13 Driveway.

A driveway is any access corridor leading from a public right-of-way to a parking lot, aisle, parking circulation area, garage, off-street parking space, or loading space. The Department of Public Service shall limit points of driveway access from residentially zoned lots abutting both an improved alley and street.

Each driveway shall be located, ~~and~~ designed, and maintained in a manner that provides for the safety of motorists and pedestrians.

- A. A driveway serving a residential parking area containing one to eight parking spaces shall have a minimum width of ten feet and a maximum width of 20 feet measured at the street right-of-way line.
- B. All other driveways shall have a minimum width of 20 feet for any two-way traffic flow and 13 feet for any one-way traffic flow with and a maximum width of 35 feet measured at the street right-of-way line or driveway throat, whichever is lesser.
- C. The minimum and maximum driveway widths as described in 3312.13A and 3312.13B may be varied with the consent of the Department of Public Service Administrator of the Department of Public Service, Division of Planning and Operations or designee, in consultation with the Division of Fire.
- D. A driveway serving a parking lot shall be designed so that vehicles entering or exiting a parking lot will be traveling in a forward motion.

3312.21 Landscaping and screening.

Landscaping and screening may be combined with storm water control measures as approved by the Director of Public Utilities, providing the requirements of this section are fulfilled. The applicant should consider the use of low-impact development strategies for managing storm water runoff and alternative pavements for reducing glare and mitigating the heat island effect from parking lot surfaces. Appropriate native plant species are recommended for landscaping and screening requirements.

Applicability. Interior landscaping, parking setback landscaping, and perimeter screening required by this section shall be indicated on the original site plan filed to obtain a certificate of zoning clearance for any newly created or newly expanded parking lot. In the case of expansion, the landscaping and screening regulations apply to new portions of a parking lot. Landscaping and screening shall be installed upon development of a parking lot or parking lot expansion.

A. Interior landscaping. The interior of any parking lot containing ten parking spaces or more and not in a parking structure shall be landscaped. Interior landscaping shall be provided at a minimum ratio of one shade tree for every ten parking spaces or fraction thereof. Interior shade trees shall conform to the following standards:

1. Trees shall be a minimum of two inches in caliper at the time of planting;
2. Trees shall be planted in landscaped islands or peninsulas containing a minimum soil area of 145 square feet per tree, allowing for flexible arrangement but designed in such a way that each tree is surrounded by a minimum radius of four feet of soil area. All trees shall be planted in a suitable soil volume, in a normal surface planting environment free from construction debris, with average soil depths greater than or equal to three feet. Islands and peninsulas shall be curbed and covered with live vegetation, decorative gravel, or mulch. Curbs on landscaped islands or peninsulas may contain openings to receive storm water runoff if islands or peninsulas are part of bioretention or other storm water control measure approved by the Director of Public Utilities.
3. Space devoted to interior landscaping shall be in addition to any required front, side or rear yard or any required screening area. Landscaped islands, shade trees, and peninsulas do not need to be uniformly spaced, but shall be contained within and dispersed proportionally throughout the interior of the parking lot or lots;
4. Planting beds for parking lot shade trees shall be arranged and constructed with suitable curbing materials so as to minimize damage to tree trunks and roots from vehicles, pedestrians and parking lot maintenance;

B. Parking setback and perimeter landscaping. Landscaping in the parking setback area shall be required to buffer automobile and pedestrian areas and uses; to provide headlight screening; to provide adequate visibility and safety; and to avoid the illegal use of said area for parking. Landscaping in the perimeter shall be required to visually buffer residentially zoned residentially-zoned property from parking lots.

1. The lot area between the right-of-way and the parking setback line shall be landscaped with plant material and shall not be paved except for approved walkways, bikeways, driveways, graphics, and other approved amenities and site elements, such as, but not limited to, electric vehicle charging stations or bike racks. Vision clearance at driveways shall be maintained.
2. Plant species shall be installed and maintained per the following standards: Shade trees shall be a minimum of two inches in caliper at the time of planting, ornamental trees shall be a minimum of one and one-half inches in caliper at the time of planting, shrubs shall be a minimum of 24 inches in height at the time of planting.
- ~~3. Perimeter parking lot screening required. Any portion of a parking lot located within 80 feet of residentially zoned property shall be screened, as hereinafter set forth, on the perimeter affecting same. For purposes of this section, "affected residential owner" shall mean any owner of residentially zoned property whose boundary lies within 80 feet of the perimeter of a parking lot; and "parking lot" shall include any parking driveway thereto. Screening is not required for those portions of parking lots abutting public alleys used for vehicular access and required vision clearance.~~
3. Perimeter parking lot screening is required when any part of a parking lot is located within 80 feet of residentially zoned property. In such instances, the parking lot shall be screened on the perimeter affecting any residentially zoned property. For purposes of this section, "parking lot" shall include any driveway thereto. Screening is not required for those portions of parking lot perimeters used for vehicular access or in required vision clearance.
4. In addition, any portion of a parking lot abutting any public street shall be screened for headlights on the perimeter adjacent to the public street regardless of the orientation of the parking spaces.

C. Screening indicated on site plan. Setback and perimeter screening required by this section shall be indicated on the original site plan filed to obtain a certificate of zoning clearance for any parking lot. Parking lot screening shall be provided to reduce headlight glare and to visually screen a parking lot from residentially zoned property within 80 feet thereof. Such parking lot screening shall be installed in accordance with the site plan and this section.

D. ~~Parking lot screening shall conform to the following standards:~~

1. Parking lot screening shall conform to the following standards:

a. For headlight screening, screening shall be provided in a landscaped area at least four feet in width and shall consist of a an opaque fence (except a chain link fence), landscaped earth mound of ~~3:1 (horizontal: vertical)~~ 1:3 (vertical: horizontal) slope, wall, planting or combination thereof installed, repaired, replaced and maintained to a total height of no less than three feet above the parking lot grade and to an opacity of not less than 75 percent.

~~b. For screening with plantings, the opacity shall be determined when plants are in leaf.~~ For buffering residentially zoned property, screening shall be provided in a landscaped area at least four feet in width and shall consist of a an opaque fence (except a chain link fence), landscaped earth mound of ~~3:1 (horizontal: vertical)~~ 1:3 (vertical: horizontal) slope, wall, planting or combination thereof installed, repaired, replaced and maintained to a total height of no less than five feet above the parking lot grade and to a year-round opacity of not less than 75 percent.

c. If a parking lot perimeter is both abutting a street and within 80 feet of residentially zoned property, screening along that perimeter shall comply with three foot high headlight screening as provided in section 3312.21D(1)(a), above.

2. Screening shall be installed and maintained in a neat and orderly manner.

3. Screening shall be reasonably uniform in height and opacity along its entire length, provided, however, that screening is not required within one foot of the ground.

4. The percentage of opacity shall be determined by measurement of any square foot of the vertical surface of the screening from a point perpendicular thereto. Permissibly open area shall not be included in the opacity determination.

5. When screening consisting of live plants is installed, alone or in combination with other materials, the plants shall:
 - a. Be selected for dense branching or foliage adequate to shade residences and adjacent rights-of-way from headlight glare;
 - b. Be selected to achieve the height and density specified in D(1) above within three years of installation;
 - c. Be ~~matured~~ to a minimum height of two feet at the time of installation; and
 - d. Be maintained in a healthy, live state and replaced as needed to comply with the original site plan and the specifications and standards herein set forth.
 - e. Exemptions. No screening shall be required for a parking lot effectively screened to this section's standards and specifications by a densely planted planting strip of at least 75 percent opacity; or existing natural or artificial barriers; providing the existing barrier has opacity of not less than 75 percent, as measured above. A parking lot need not be screened from the use it serves.
- E. All plants shall be maintained in a healthy, live state and replaced as needed to comply with the original site plan and the specifications and standards herein set forth. Dead plants shall be replaced within the next growing season.

3312.23 Maintenance.

The owner or operator of property designed or used for parking, circulation, driveways, and or loading shall maintain such area in good condition so that it is safe, clean, dust-free, and free of any hazard, nuisance or other unsafe condition. Striping for parking spaces shall be maintained in good condition.

3312.25 Maneuvering.

Every parking and loading space shall have sufficient access and maneuvering area. Sufficient access and maneuvering area is equivalent to the minimum aisle widths presented in C.C. 3312.09, Aisle. The maneuvering area for a parking space may occur anywhere on a lot except in the area between the street right-of-way line and the parking setback line. The maneuvering area may include an aisle, circulation area, or improved alley.

Exceptions: ~~The maneuvering area may include an aisle, circulation area, or improved alley.~~ In single-family or two-family residential districts or in town house developments, For single-unit and two-unit dwellings, and multi-unit dwellings with individual garage/driveway arrangements, the maneuvering area may include a driveway, street, or another parking space.

The Department of Public Service Director of Public Service may waive the requirement for maneuvering area only for a parking lot ~~which~~that has and continues to have an operator on duty during all hours of operation.

3312.27 Parking setback line.

A parking setback line establishes how close parking, vehicle display, loading or maneuvering may be located to a street right-of-way line. This line shall be located a minimum distance from a street right-of-way line and be related to a building line as follows:

1. On unimproved frontage the parking setback line shall coincide with the required building setback line.
2. Where a required building setback line is 25 feet or greater, the parking setback line shall be 25 feet from the street right-of-way line.
3. Where a required building setback line is less than 25 feet, the parking setback line shall follow the building setback line or the established parking setback, whichever is less, but in no case shall the parking setback line be less than ten feet from the street right-of-way line.
4. In C-1, C-2, C-3, C-4, and C-5 Commercial Districts, ~~and for commercial uses located in M-Manufacturing Districts~~ where there are only commercial district uses developed, the parking

setback line shall be established ten feet from the street right-of-way line without respect to the building line.

5. Exception: Where a parking setback line is specifically established by Council ordinance, zoning district, overlay, or subdivision plat, the parking setback line shall conform to that requirement.

3312.29 - Parking space.

~~A~~-A parking space shall be a rectangular area of not less than nine feet by 18 feet, exclusive of any driveway or other circulation area; shall be accessible from a street, alley, or maneuvering area; and shall be designed for parking a motor vehicle. ~~Exception: For single family and two-family dwellings, and multi-family units with individual garage/driveway arrangements, one vehicle may be stacked behind each required off-street parking space and be located between the parking setback line and the street right-of-way line. For such dwellings, stacked parking shall be located in a driveway, and not in any other part of a required yard. These stacked parking spaces may not be counted as required parking spaces for units not served directly by the driveway/garage. Required vision clearance shall be maintained.~~

3312.30 Parking in a driveway.

For single-unit and two-unit dwellings, and multiple units with individual garage/driveway arrangements, one off-street parking space may be stacked behind each off-street parking space and such stacked spaces may be located between the parking setback line and the street right-of-way line. Stacked parking may be located in a driveway behind a code compliant parking space and not in any other part of a required yard. Stacked parking may be included in and calculated as required parking only for a residential use with an attached one-car garage. Required vision clearance shall be maintained.

3312.31 Parking space for ADA compliance.

~~A. The Department of Public Service may maintain a striping and signage policy for ADA parking spaces that meets or exceed exceeds the requirements of the Ohio Building Code.~~ Parking spaces for ADA compliance shall meet the requirements of the Ohio Building Code and any departmental policy. Each such space may be included in the computation of required space as specified in this chapter.

3312.33 Parking space for a small car.

~~A~~-Excess parking over and above the minimum required by this chapter may be designed to accommodate small cars. The design and placement of each space shall be reviewed and approved by the Department of Public Service ~~Director of Public Service~~ prior to approval by this department.

3312.35 Parking or keeping of recreational and commercial vehicles in residential districts
Prohibited parking.

A. In residential districts, no required off-street parking space, no parking space in front of the setback line, no unimproved surface, and no required front, side or rear yard ~~or unimproved surface~~ shall be used for the parking or storage of a boat, trailer, trailer or tow dolly, camping trailer, or other recreational vehicle.

B. No commercial vehicle shall be stored or parked on a residentially zoned lot. However, infrequent, short-term parking of a commercial or commercial-type vehicle for conveying tools and materials to premises where labor using such tools and materials is being performed, delivering goods to a residence, or moving furniture to or from a residence, all only during the time such parking is actually necessary, is hereby excepted from this section.

For purposes of this section, "commercial vehicle" includes, but is not necessarily limited to: a bus, cement truck, commercial tree-trimming equipment, construction equipment, dump truck, garbage truck, panel truck, semi-tractor, semi-trailer, stake bed truck, step van, tank truck, tar truck, or other commercial-type vehicle licensed by the Ohio State Bureau of Motor Vehicles as a commercial vehicle or truck.

3312.37 Parking or keeping inoperable motor vehicle.

No person shall use any premises in any ~~residential, apartment, or institutional use district, private or public parking district, or C-1, C-2, C-3 or C-4 commercial use zoning~~ district for the purpose of parking or keeping an inoperable motor vehicle except when ancillary to a specifically permitted use that allows and has provided for the same on an approved site plan in a C-4 Commercial or a Manufacturing Zoning District. As used in this section, "keeping an inoperable motor vehicle" means and includes storing, maintaining, collecting, depositing, reserving, allowing to stand, or permitting to remain, one or more inoperable motor vehicles at any place other than in an enclosed garage.

For purposes of this section, a motor vehicle shall be deemed inoperable when any of the following conditions exist: one or more wheels are missing; one or more tires are missing; two or more tires are flat; one or more windows are missing or broken; the windshield is shattered or missing; parts necessary for the operation of the vehicle are missing; or a license with a distinctive number and valid for the current year is not displayed thereon.

3312.41 ~~Access~~ Pedestrian access and circulation.

Access and circulation standards are as follows, all sidewalks and crosswalks internal to a development shall have a minimum width of four (4) feet:

- A. A pedestrian sidewalk or walkway shall be provided along the front of a commercial building that contains multiple tenants.
- B. Pedestrian sidewalks or striped crosswalks shall be provided from buildings to public sidewalk systems.
- C. The Department of Public Service may waive this requirement for utility buildings, self-storage buildings or for other buildings where pedestrian access may be prohibited, where unsafe conditions may be created by encouraging pedestrian traffic, or where pedestrian sidewalks or striped crosswalks serve no purpose for any residents, tenants, patrons or employees on a site.
- D. The Department of Public Service may require that pedestrian sidewalks be provided on both sides of a driveway or aisle connecting to a public street to avoid circuitous pedestrian routes or to promote safe pedestrian circulation within a site.

3312.43 ~~Improved surface required. Required surface for parking.~~

The surface of any parking area; including but not limited to a parking, loading or stacking space; circulation area; aisle or driveway shall be designed to control storm water runoff and be improved with Portland cement, asphaltic concrete or other approved hard surface other than gravel or loose fill. Applicants are encouraged to consider use of permeable surfaces as a means of reducing storm water runoff. Applicants may also consider lighter color finishes for surface materials, which reflect solar energy and minimize heat islands. Hard surface materials other than concrete and asphalt may be permitted and are subject to additional review and prior approval by relevant departments and divisions. ~~This section is intended to apply~~ applies to any parking, loading, stacking, driveway, or maneuvering area regardless of whether such area is required. Exception: The director may waive the hard surface requirement for a use located in a manufacturing district when the proposed parking space or parking area is located at least 400 feet from any residential district.

3312.49 ~~Minimum numbers of parking spaces required. Required parking.~~

The number of off-street parking spaces required for various uses shall be no less than as set forth in the parking requirements tables.

Bicycles.

A. Bicycle parking design standards. The Department of Public Service ~~Director of Public Service~~ shall review and approve required bicycle parking as part of overall site plan review. ~~Specification requirements will be maintained by the Department of Public Service.~~

Bicycle Parking Design and Location Requirements

- ~~1. Bicycle parking shall be located in highly visible areas near the intended use.~~
- ~~2. Bicycle parking racks shall be positioned out of walkway clear zones and not pose a tripping hazard for visually impaired pedestrians.~~
- ~~3. Bicycle parking racks shall be located to avoid potential conflict with parking and circulation of motor vehicles.~~
- ~~4. Bicycle parking racks shall be of the inverted "U" type design, unless an alternative design has been approved by the Public Service Department. See Figure 3.~~
- ~~5. Bicycle parking racks shall support a bicycle upright in two places.~~
- ~~6. Bicycle parking racks shall enable the bicycle frame and one or both wheels to be secured through use of a "U" type lock.~~
- ~~7. Bicycle parking racks shall be securely anchored to an approved hard surface.~~
- ~~8. A two foot by six foot space is required to accommodate two bicycles.~~
- ~~9. Parallel bike racks shall be a minimum on-center spacing of 30 inches. Spacing of 48 inches is optimal.~~

~~Additional guidance and requirements as necessary will be maintained by the Public Service Department.~~

Figure 3.

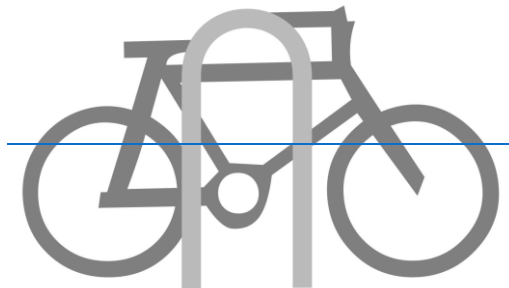

B. Bicycle parking shall be provided as required in Tables 1-4, or as approved by the Director of Public Service. A minimum of two bicycle spaces shall be provided for the uses noted "Yes" in Tables 1-4. Additional bicycle parking is required for uses with over 20 vehicle parking spaces at a rate of one bicycle parking space per 20 vehicle parking spaces up to a maximum of 20 bicycle parking spaces. For purposes of this provision, vehicle parking spaces are determined based on the total required by code for a use, not the amount available or provided.

B. Bicycle parking in the form of bicycle racks shall be provided per Table 1 where indicated as required in Section C below, or as approved by the Department of Public Service, and calculated based upon the number of required vehicle parking spaces before any reductions or variances are granted.

Table 1. Bicycle parking requirements table

<u>Total No. of Vehicle Parking Spaces Required</u>	<u>Total No. of Bicycle Racks Required</u>
---	--

<u>1-20</u>	<u>1</u>
<u>21-60</u>	<u>2</u>
<u>61-100</u>	<u>3</u>
<u>101-140</u>	<u>4</u>
<u>141-180</u>	<u>5</u>
<u>181-220</u>	<u>6</u>
<u>221-260</u>	<u>7</u>
<u>261-300</u>	<u>8</u>
<u>301-340</u>	<u>9</u>
<u>341+</u>	<u>10</u>

Each bicycle rack shall, at a minimum, provide space for two bicycles.

C. Parking requirements tables.

NOTE: sf = square feet of gross floor area

Table 12. Parking requirements for residential uses

LAND USE	SPACES MINIMUM	SPACES MAXIMUM	BICYCLE PARKING
RESIDENTIAL USES			
1, 2, or 3 dwelling units	2 per unit	NA	NA
4 or more dwelling units	1.5 per unit	NA	Yes
Rest home, nursing home, or home for the aging	0.75 per unit	NA	Yes
Civic spaces, plazas, clubhouses, and recreational areas	NA	NA	Yes

Table 23. Parking requirements for retail and other commercial uses Requirements for Retail and Other Commercial Uses

LAND USE	SPACES MINIMUM	SPACES MAXIMUM	BICYCLE PARKING
EATING and/or DRINKING ESTABLISHMENTS			
<u>Without pickup unit or > 5,000 Sq. Ft. Eating and Drinking Establishment</u>	1:75 sf	1:50 sf NA	Yes
<u>w/pickup unit & seating (<5,000 Sq. Ft.) Eating and Drinking Establishment with at least one pickup unit and having less than 5000 Sq. Ft. gross floor area</u>	1:175 sf	1:50 sf NA	Yes
<u>w/pickup unit no seating (<5,000 Sq. Ft.)</u>	1:175 sf	1:50 sf	Yes
<u>Accessory eating & drinking establishment</u>	1:175 sf	1:50 sf	Yes
Patios/outdoor dining areas	Ratio is 50% of ratio required for primary structure	1:50 sf	Yes
<u>Catering as a standalone use with no public areas</u>	1:450 sf	NA	Yes
RETAIL			
10,000 Sq. Ft. or less	1:250 sf	1:200 sf	Yes.

10,001-100,000 Sq. Ft.	1:275 sf	1:200 sf	Yes
>100,000 Sq. Ft.	1:300 sf	1:200 sf	Yes
Accessory retail	1:250 sf	1:200 sf	Yes
Furniture stores	1:1000 sf	1:200 sf	NA Yes *
<u>Retail uses include, but are not limited to, financial services, personal health, fitness, and beauty services, and any retail outdoor display area</u>			
<u>SHOPPING CENTER COMMERICAL CENTERS</u>	1:300 sf	1:200 sf	Yes
<u>Greater than 100,000 sf GFA</u>	<u>1:300 sf</u>	<u>1:200 sf</u>	<u>Yes</u>
Small commercial centers of 10,000 75,000 to 100,000 GFA 150,000 sf, which have a minimum of 3 distinct businesses, and no more than 30% eating and drinking establishments	1:275 Except sf of eating and drinking establishments exceeding 50% 30% of total GFA, 1:75 sf	1:200	Yes
OFFICES and MEDICAL USES			
General office	1:450 sf	1:250 sf	Yes
Call center	1:300	1:200	Yes
Hospital	2.5 spaces per bed	NA	Yes
Medical office	1:300 sf	1:200 sf	Yes
Other non-residential medical care	1:300 sf	1:200 sf	Yes
LODGING			
Hotel or motel	1 per guest room	NA	Yes
Rooming house	1:400 sf	NA	Yes
Apartment hotel	1:400 sf	NA	Yes
Dormitory	1:400 sf	NA	Yes
AUTOMOBILE			
Auto repair	2 per service bay	NA	Yes*
Boat and RV sales	1:5000 square feet of lot area used for vehicle display and 1:300 sf of building	NA	Yes*
Car and truck sales	1:5000 square feet of lot area used for vehicle display and 1:300 sf of building	NA	Yes*
Car wash	2 per site	NA	Yes*
<u>Accessory service bays and car washes not for public use</u>	NA	NA	NA
Fuel sales	2 per site	NA	Yes

*These uses require a minimum of two bicycle parking spaces.

Table 34. Parking requirements for institutional, educational and athletic uses

LAND USE	SPACES MINIMUM	SPACES MAXIMUM	BICYCLE PARKING
DAY CARE			
Adult day care	1:500 sf	NA	Yes
Child day and care	1:500 sf	NA	Yes
<u>Pet day care</u>	<u>1:500 sf</u>	<u>NA</u>	<u>Yes</u>
PLACES of ASSEMBLY			
Civic, fraternal, religious, or other assembly or institutional organizations, primary uses	1:30 sf of sanctuary, auditorium or main place of assembly	NA	Yes
Civic, fraternal, religious, or other institutional organizations, non-assembly areas	1:250 <u>500 sf of non-assembly areas</u>	NA	Yes
Funeral parlor	1:150 sf	NA	Yes
Stadium	1:30 sf of assembly space	NA	Yes
Theater	1:30 sf of auditorium	NA	Yes
SCHOOLS			
Elementary school or middle school	1:1000 sf; or 1:60 square feet of assembly areas, whichever is greater	NA	Yes
High school, business, technical or trade school	1:1000 sf; or 1:60 square feet of assembly areas; or 1:30 square feet of assembly space in stadium, whichever is greater	NA	Yes
University or college	1:1000 sf or 1:60 square feet of assembly areas; or 1:30 square feet of assembly space in stadium, whichever is greater	NA	Yes
ATHLETIC FACILITIES			
Bowling alley	4 per lane	NA	Yes
Fitness club	1:250 sf	NA	Yes
Skating rink	1:100 sf	NA	Yes
Spectator sports other than stadium <u>and swimming pools</u>	1:60 square feet of assembly area	NA	Yes
Swimming pool	1:50 square feet of water surface area and 1:30 sf of spectator seating areas	NA	Yes
Tennis or racquetball	2 per court	NA	Yes
CULTURAL USES			
Art gallery	1:400 sf	NA	Yes

Library	1:400 sf	NA	Yes
Museum	1:400 sf	NA	Yes

Table 45. Parking requirements for industrial and manufacturing uses

LAND USE	SPACES MINIMUM	SPACES MAXIMUM	BICYCLE PARKING
INDUSTRIAL USES			
Warehousing	1 per motor vehicle used in the business and based, for operational purposes, upon the premises; PLUS For the first 20,000 sf, 1:1000 sf PLUS For any amount between 20,000 sf and 120,000 sf, 1:5000 sf PLUS For any amount above 120,000 sf, 1:10,000 sf	NA	NA
Manufacturing or other industrial uses	1 per motor vehicle used in the business and based, for operational purposes, upon the premises; PLUS For the first 20,000 sf, 1:750 sf PLUS For any amount between 20,000 sf and 120,000 sf, 1:1500 sf PLUS For any amount above 120,000 sf, 1:3000 sf	NA	NA
Self-storage	<u>1 per 50 internal storage units or as otherwise approved by the Department of Public Service.</u> As approved on transportation plan	NA	NA

3312.53 Minimum number of loading spaces required.

The number of off-street loading spaces required for various types of uses shall be no less than as set forth in the following:

Loading spaces, if required by this section, shall be indicated on the original site plan filed to obtain a certificate of zoning clearance for any newly created or expanded parking lot. Loading spaces, if required, shall be installed upon development of a parking lot or parking lot expansion.

A. Each use of a business, institutional, personal or professional service nature including but not limited to a business office, hotel, motel, recreational or entertainment type shall provide loading spaces based on gross floor area as follows:

1. 50,000 square feet or more; one space.
 2. Over 250,000 square feet; one space for each 250,000 square feet or portion thereof.
- B. Each commercial or industrial type use involving the retail or wholesale exchange, sale, storage, processing, or manufacturing of merchandise or personal property of any type, including eating and drinking establishments, which is permitted in any commercial or manufacturing district, shall provide loading spaces based on gross floor area as follows:
1. Under 10,000 square feet; none.
 2. 10,000 square feet or more but less than 75,000 square feet; one space.
 3. 75,000 square feet or more but less than 150,000 square feet; two spaces.
 4. 150,000 square feet or more but less than 300,000 square feet; three spaces.
 5. Over 300,000 square feet; one space for each 100,000 square feet or portion thereof.
- The loading space requirements for buildings with multiple uses or tenants shall be determined based on the aggregate total of gross floor area of all uses or tenants.

3312.56 Electric vehicle parking administrative requirements

A. General Requirements.

1. An Electric Vehicle (EV) is defined as a motor vehicle that uses one or more electric motors for propulsion. Onboard batteries provide electricity for propulsion, which can be charged using Electric Vehicle Supply Equipment (EVSE).
2. For EVSE Installed pursuant to this Chapter, the owner or their designee shall provide to the City on an annual basis such standard utilization data as may be required by rules promulgated under this chapter.
3. Electric Vehicle parking spaces shall meet all performance standards of Chapter 3312.
4. EV Readiness requirements are categorized in three levels as follows:
 - a. *EV Capable*: These parking spaces provide dedicated conduit from the planned location of a breaker or sub panel expansion to the EV Capable parking spaces.
 - b. *EV Ready*: These parking spaces provide dedicated electrical panel capacity, conduit, and wiring installed with termination at an outlet to the EV Ready parking space.
 - c. *Electric Vehicle Supply Equipment (EVSE Installed)*: These parking spaces provide dedicated panel capacity, conduit, and EVSE Installed, as defined by rules promulgated under this chapter.

B. Technical Specifications, Rules.

The Director of the Department of Building and Zoning Services shall promulgate rules and regulations for the administration of the Technical Specifications of Sections 3312.55 through 3312.58 which may change over time due to changing technologies for EVSE in electric-powered vehicles, as well as any other rules reasonably necessary for the effective implementation of EV Ready parking such as are not in conflict with applicable provisions of Columbus City Code.

C. Number of Spaces Required.

1. The parking requirements of this Chapter are intended to provide minimum standards. The EV parking requirements are based on a percentage of the minimum required parking spaces per a project's approved zoning after approval of any variance thereto. If the project includes parking above the minimum requirements of this Code, such additional parking shall be exempt from the minimum EV Capable, EV Ready, or EVSE Installed requirements herein.
2. Where the calculation of percent served results in a fractional parking space, it shall be rounded up to the next whole number.

3. The total number of EV Capable or EV Ready spaces required shall decrease by the total number of EVSE Installed spaces that exceed the minimum required percentages for EVSE Installed provided in Sections 3312.57 and 3312.58 below.
4. These standards are subject to variance as provided for in Chapter 3307.
5. For existing parking lots, the removal or displacement of parking spaces due to the installation of EV charging stations and associated equipment, are permitted without a parking space reduction variance so long as the minimum number of required parking spaces is not reduced by more than one parking space, or 2% of the total number of required spaces, whichever is greater (standard rounding rules apply).

D. Design.

1. Charging equipment must be mounted on the wall or on a structure adjacent to the EV parking space.
2. No charging devices may be placed within the dimensions of a space.
3. When cords and connectors are not in use, retraction devices or locations for storage shall be located sufficiently above the pedestrian surface and the parking lot as to reduce conflicts with pedestrians and vehicle maneuvering.
4. Cords, cables, and connector equipment shall not extend across the path of travel in any sidewalk.
5. Equipment mounted on structures such as pedestals, lighting posts, bollards, or other devices shall be located in a manner that does not impede pedestrian, bicycle, or transit travel.
6. Upon a showing of good cause, alternative designs may be approved by the Director or their designee.
7. Per rules adopted by the Director, ~~and in conformity with this Chapter, additional landscape screening may~~ shall be required for charging stations and/or related mechanical equipment such as transformers in excess of 60 inches in height and 30 square feet associated with charging equipment, consistent with ~~mechanical equipment screening requirements in Section 3312.21 Landscaping and screening, or~~ Section 3321.11 Screening of mechanical systems.

E. Accessibility.

1. A minimum of one (1) EVSE Installed space must be located adjacent to an Americans with Disabilities Act (ADA) Accessibility designated space to provide access to the charging station.
2. The EVSE Installed accessible spaces must comply with ADA Guidelines referenced in Section 3312.31 Parking space for ADA compliance.
3. The EVSE Installed accessible spaces shall have all relevant parts located within accessible reach, and in a barrier-free access aisle for the user to move freely between the EVSE and the EV.

F. Enforcement.

The owner shall retain exclusive authority to enact and enforce reasonable rules governing access to and use of EVSE Installed parking space(s) not in the public right of way. Any EVSE Installed parking space that the owner designates as exclusively for EV charging, in whole or in part, shall include signage in compliance with the Federal Highway Administration Manual on Uniform Traffic Control Devices for Streets and Highways (FHWA MUTCD) standards applicable to EV charging, as such manual may be amended, or re-issued, by its successor in interest. All other EVSE Installed parking spaces shall include signage denoting the availability of EV charging and shall be substantially similar in design to FHWA MUTCD standards applicable to EV charging. EV parking spaces shall not be required to be exclusively reserved for EV vehicles. Owners shall have the right to enforce EV parking restrictions and reserve the use of EV spaces for residents, employees, and patrons, unless otherwise required by local, state, or federal rules, regulations, or laws.

Chapter 900 DEFINITIONS

900.01 Meaning of words and phrases.

The following words and phrases when used in Chapters 900-908 of this Streets, Parks and Public Properties Code except as otherwise provided, shall have the meaning respectively ascribed to them in this chapter. Words not defined shall be given their common and ordinary meaning.

900.021 Authorized agent.

“Authorized agent” for the abutting property owner shall mean a contractor having an active valid home improvement contractor’s (HIC) license on file with the Department of Building and Zoning Services.

900.022 Bike lane.

"Bike lane" (Class II Bikeway) is a marked lane contiguous to a travel lane within a roadway for the exclusive or semi-exclusive operation of bicycles in the same direction as the adjacent travel lane. The bike lane is physically separated from motor vehicle traffic by painted lines, pavement coloration, curbing, parked vehicles or other barriers.

900.023 Bike route.

"Bike route" (Class III Bikeway) utilizes existing streets and roads. No separation of motor vehicle and bicycle traffic is provided as only signs are present to indicate the course of the bike route.

900.03 Bikeway.

"Bikeway" means a facility that explicitly provides for bicycle travel. A bikeway may vary from a completely separated facility to simple signed streets as follows: (a) "Shared-use path"; ~~(Class I Bikeway) is a facility for the exclusive use of bicycles, pedestrians and children's non-motorized vehicles separated from motor vehicle traffic except at bike crossings-~~(b) "Bike lane"; ~~and (Class II Bikeway) is a marked lane contiguous to a travel lane within a roadway for the exclusive or semi-exclusive operation of bicycles in the same direction as the adjacent travel lane. The bike lane is physically separated from motor vehicle traffic by painted lines, pavement coloration, curbing, parked vehicles or other barriers.~~ (c) "Bike route"; ~~(Class III Bikeway) utilizes existing streets and roads. No separation of motor vehicle and bicycle traffic is provided as only signs are present to indicate the course of the bike route.~~

900.031 Commercial activity.

"Commercial activity" means the ordinary activities of trade and commerce where the profit motive is the primary purpose of the temporary commercial zone. This terminology does not apply to sales of materials which are intended to convey information and ideas, or which espouse causes or beliefs protected by the First Amendment to the U.S. Constitution, whether in the form of books, pamphlets, buttons, bumper stickers t-shirts, or the like.

900.04 Crosswalk.

"Crosswalk" means:

- (a) (1) That part of a roadway or alley at intersections, ordinarily included within the real or projected prolongation of property lines and curb lines or, in the absence of curbs, the edges of the traversable roadway;
 - (2) If the service director authorizes curb ramps which are outside the crosswalk established by subsection (a)(1) but within fifteen (15) feet of that crosswalk, the crosswalk shall be extended to encompass the pathway between two (2) opposed ramps; and
 - (3) Any portion of a roadway at an intersection or elsewhere, distinctly indicated for pedestrian crossing by lines or other markings on the surface;
- (b) Notwithstanding subsections (a)(1), (2~~b~~) and (3~~e~~) of this section, there shall not be a crosswalk where authorized signs have been placed indicating no crossing.

900.041 Department.

"Department" when used without clarification means the Department of Public Service.

900.042 Director.

"Director" when used without clarification shall mean the Director of Public Service or designee.

900.051 Litter.

"Litter" means garbage, trash, waste, rubbish, ashes, cigarette butts, cigar butts, cans, bottles, wire, paper, cartons, boxes, automobile parts, furniture, glass, debris, leaves, dead and decaying material, human excreta or any refuse of any description or any other thing, matter, or substance which may accumulate in an unsightly, unsanitary, or unsafe manner.

900.052 Owner.

"Owner" means any of the following:

- (a) The owner of record as shown on the current tax list of the county auditor in which the property is located;
- (b) The mortgage holder of record, if any, as shown in the mortgage records of the county recorder in which the property is located;

- (c) Any person who has a freehold or lesser estate in the premises;
- (d) A mortgagee or vendee in possession. "In possession" means someone who evidences charge, care or control of the premises, and includes someone to whom the county sheriff in which the property is located has issued a deed for the premises whether or not the deed has been recorded;
- (e) Any person who has charge, care or control of the premises as agent, executor, administrator, assignee, receiver, trustee, guardian or lessee; or
- (f) Any person who holds themselves out to be in charge, care or control of the premises as evidenced by negotiating written or oral lease agreements relative to the premises, collecting rents for the premises, performing maintenance or repairs on the premises or authorizing others to perform maintenance or repairs on the premises.

900.053 Person.

"Person" means, without limitation, an individual natural person, the person's beneficiaries, executors, administrators, or assigns, a corporation, partnership, unincorporated society or association, public service agency, or any other type of business or association, including respective successors or assigns, that is recognized under the laws of the State of Ohio or the City of Columbus, or anyone acting on behalf of any of the aforementioned, and who is working in or occupying the right-of-way with or without a valid permit issued by the Department.

900.06 Right of way.

"Right of way" means either of the following, as the context requires:

- (a) The right of a vehicle or pedestrian to proceed uninterruptedly in a lawful manner in the direction in which it or the individual is moving in preference to another vehicle or pedestrian approaching from a different direction into its or the individual's path;
- (b) A general term denoting land, property or the interest therein, usually in the configuration of a strip, acquired for or devoted to transportation purposes. When used in this context, right of way includes the roadway, shoulders or berm, ditch and slopes extending to the right-of-way limits under the control of the state or local authority. This includes the surface of and the space above and below the paved or unpaved portion of any public street, road, highway, shared-use path, sidewalk, drive or any other land dedicated or otherwise designated for the same now or hereafter held by the City

900.061 Shared-use path.

"Shared-Use Path" (Class I Bikeway), means a bikeway outside the traveled way and physically separated from motorized vehicular traffic by an open space or barrier and either within the highway right-of-way or within an independent alignment. A shared-use path also may be used by pedestrians, including skaters, joggers, users of manual and motorized wheelchairs, and other authorized motorized and non-motorized users. A shared-use path does not include any trail that is intended to be used primarily for mountain biking, hiking, equestrian use, or other similar uses, or any other single track or natural surface trail that has historically been reserved for nonmotorized use.

900.081 Structure

"Structure" shall mean any object which is assembled, built, constructed, or erected in a stationary location on the ground that, while not permanently affixed to the ground, is not easily movable including, but not limited to, bandstands, platforms, podiums, tables, and tents.

900.082 Temporary commercial zone.

"Temporary commercial zone" means the closing of one (1) or more parking locations in the public right of way between one (1) or more intersections, while maintaining vehicular traffic access on the street, road, or alley, for the purpose of conducting commercial activity, including mobile food vending.

900.09 Vehicle.

"Vehicle" means every device, including a motorized bicycle and an electric bicycle, in, upon or by which any person or property may be transported or drawn upon a street or highway, except that "vehicle" does not include any motorized wheelchair, any electric personal assistive mobility device, any low-speed micromobility device, any personal delivery device as defined in section 4511.513 of the Revised Code, ~~or~~ any device that is moved by power collected from overhead electric trolley wires or that is used exclusively upon stationary rails or tracks, or any device, other than a bicycle, that is moved by human power.

Chapter 901 IMPROVEMENTS AND REPAIRS

901.01 Agreements to improve street areas.

Upon receipt of requests for the right and privilege to cause the improvement of any public street, avenue, boulevard or alley in the city, the ~~D~~director of ~~public service~~ is authorized to enter into agreements, granting such right and privilege, and such agreements shall contain the following provisions and conditions:-

- (a) The pavements so constructed shall be in accordance with plans to be approved by the ~~D~~director of ~~public service and their designee~~, which plans shall meet the standard minimum requirements as adopted by the city council.
- (b) The ~~D~~director of ~~public service and/or their designee~~ shall furnish detailed specifications, which shall be complied with in every respect.
- (c) The grades of the streets, alleys or other public ways to be so paved shall be as shown on the plans therefor and shall be recorded in the profile books maintained by the ~~D~~department of ~~public service~~.
- (d) The city shall be held free and harmless from any and all claims for damages of every nature arising or growing out of the improvements so agreed to be made.
- (e) The party requesting such right and privilege shall pay the costs of inspection and the cost of fire hydrants and shall deposit, with the ~~C~~city ~~T~~reasurer through the ~~D~~director of ~~public service and/or their designee~~, the sums of money estimated by the ~~D~~director of ~~public service and/or their designee~~ to be necessary therefor, and in the event that such estimated amounts are found to be insufficient shall deposit such additional amounts as are necessary upon demand. All unexpended monies so deposited shall be refunded.
- (f) Such party shall furnish a surety bond or an irrevocable letter of credit issued by a bank and subject to the provisions of Chapter 1305 of the Ohio Revised Code satisfactory to the ~~D~~director of ~~public service~~, or an escrow agreement acceptable to the ~~C~~city ~~A~~ttorney and ~~D~~director of ~~public service~~, or a certified check upon a solvent bank of the city, in the sum of one hundred (100) percent of the estimated cost of the proposed improvements to guarantee the performance of the agreement.
- (g) Any violation of the terms of the agreement or noncompliance therewith shall constitute a breach of contract and the ~~D~~director of ~~public service and/or their designee~~ shall have the right and privilege to stop the work forthwith.
- (h) Upon completion of the work in accordance with the plans and specifications therefore, the pavements shall become the property of the city at no cost to the city and without encumbrance of any nature.
- (i) City council shall by ordinance establish and periodically amend a schedule of fees for the review of street plans. All fees are for the purpose of defraying costs incurred by the ~~D~~department of ~~public service~~ for reviewing street plans to assure conformance to city specifications. Once the fee has been paid it shall not be refundable. The ~~D~~director of ~~public service and/or their designee~~ shall not release street plans for construction until the fee has been paid in full. All fees shall be paid to the ~~C~~city ~~T~~reasurer for deposit into the

~~D~~evelopment ~~S~~ervices ~~S~~pecial ~~R~~evenue ~~F~~und. The schedule of fees and service charges shall be posted in the ~~D~~epartment's ~~o~~f public service offices.

- (j) All fees collected are for the purpose of paying for services rendered by the ~~D~~epartment of public service for coordinating, directing, inspecting and supervising the construction of streets, highways, bridges, storm sewers, sanitary sewers, street lighting, water distribution lines, traffic control devices and any other city-owned or operated facility and such other related matters as may arise in connection with such construction to assure conformance to city specifications. All fees shall be paid to the ~~C~~eity ~~T~~reasurer for deposit into the ~~B~~uilding ~~S~~ervices ~~S~~pecial ~~R~~evenue ~~F~~und. ~~C~~ity ~~C~~ouncil shall, by separate ordinance, establish and periodically adjust the fees for all types of applications and review provided by the ~~D~~epartment of public service, hereinafter referred to as the "Fee Schedule," for the purpose of defraying the costs of providing service. The fee in effect on the date of receipt of any application shall be the fee charged.

901.02 Improvements for purpose of developing subdivisions.

In the event that a street improvement or sewer construction, or any other comparable improvement, made on an assessment basis for the purpose of developing subdivisions, is sought by petition, the following procedure and petitioner requirements are to be in full force and effect for the sole purpose of facilitating an equitable, business-like and timely action by the city council upon such petitions for street improvements or sewer construction or other comparable improvement:

- (a) Each such petitioner shall, at the time of filing a petition with the Ceity Clerk, deposit the sum of not less than one hundred fifty dollars (\$150.00) nor more than three hundred dollars (\$300.00), as may be determined by the Ceity Attorney, which such deposit shall be for the appraisal services in connection with the proposed improvement or construction, and shall secure the cost of appraisers' fees and cost of the appraisal board's valuation and feasibility report. The Ceity Clerk shall remit any such deposit to the ~~D~~irector of public service and/or their designee who shall credit such deposit to the credit of the Street Construction Maintenance and Repair Fund. Any such part of any such deposit so made as is found to be in excess of the fee charged by appraisers, shall be refunded by the ~~D~~irector of public service and/or their designee to the depositor within a reasonable time after such determination is made.
- (b) There is created a board to be known as the Street Improvement and Sewer Construction Appraisal Board. Such board shall consist of three (3) members, two (2) to be regularly qualified and acting realtor members of the Columbus Real Estate Board, and one (1) member being a duly qualified and practicing Ohio-registered professional civil engineer. Each such board member shall at all times be a freeholder and a bona fide resident of the city. Members of the board shall be appointed by the Ceity Attorney and shall serve for the term of one (1) year from the date of appointment, or until such time thereafter as a qualified successor is appointed. In case of the death, resignation or removal by reason of disqualification, of any member of such board, successor board members shall be appointed by the Ceity Attorney in like manner as the original appointments are made.
- (c) It shall be the duty of the Street Improvement and Sewer Construction Appraisal Board to make a timely survey of each such proposed improvement or construction and an appraisal of the values of each and every parcel of real estate affected, the cost of each street improvement or sewer construction or other improvement project, and forthwith to make a full and complete written report of each such survey and appraisal to the city council. Copies of

such report shall be submitted to the ~~D~~irector of public service and/or their designee and ~~C~~eity ~~A~~ttorney, such report to contain the board's findings and conclusions as to each such valuation or costs; the feasibility of such improvement or construction, and the board's recommendations to the city council in connection therewith, particularly referable to the justifiable risk or nonjustifiable risk of the city in ordering such proposed improvement or construction. Such original report in each such instance shall be filed with the Ceity Celerk. Such reports of the board shall be considered confidential and the city council shall consider each such report with respect to any such proposed street improvement or sewer construction, or other comparable improvements, together with the ~~D~~irector of public service and/or their designee's report as to the estimated cost of such improvement or construction, and each such report shall also be used by the city council to assist it in the determination of its course of action in either approving or disapproving the street improvement, or sewer construction or other comparable improvement, as sought by the petitioners.

Chapter 902 HEALTH AND SAFETY

902.00 Right to enforce.

The ~~Director~~ ~~director of the public service department~~, the director of the department of public safety, the director of the department of building and zoning services, the health commissioner, and their designees shall have the authority to enforce all relevant ~~healthy~~ health and safety related laws under the Ohio Revised Code and Columbus City ~~Code~~ Codes Chapter 902.

902.01 Littering.

- (a) No person, regardless of intent, shall deposit litter, cause litter to be deposited, or allow litter to accumulate in an unsightly, unsanitary, or unsafe manner on any public property, on any private property, or in or on waters of the city, or convey or carry through any street, square, court, lane, avenue, alley, or other public place, any liquid refuse matter or slops of any kind, unless such liquid refuse matter is conveyed in watertight wagons, carts, vehicles, or vessels.
- (b) Persons engaged in the repair or construction of any building in the city may occupy certain portions of a street or sidewalk as authorized by the ~~director of public service and/or their designee~~ Director as required by Chapter 903 of the Columbus City ~~Code~~ Codes.
- (c) In the event any person causes or permits the littering of streets or alleys with dirt, mud, debris or excavating or building materials, such person shall clean and/or remove such litter.
 - (1) Upon failure of any person to remove such dirt, mud, debris or excavating or building materials, then cleaning service shall be rendered by the ~~department of public service~~ Department and the person billed at the current hourly rates of the ~~department of public service's~~ Department's equipment and personnel.
 - (2) Failure to pay such bill within ten (10) days shall be grounds for revocation of any and all city permits, licenses, performance bonds, and letters of credit issued to or posted by such person and for refusal to issue any new permits or licenses for so long as the bill remains unpaid.
- (d) The littering of streets adjacent to any project for which a city permit or license was issued shall be deemed to have been caused or permitted by the permittee or licensee in the absence of proof to the contrary.
- ~~(e) As used in this section:~~
 - ~~(1) "Litter" means garbage, trash, waste, rubbish, ashes, cigarette butts, cigar butts, cans, bottles, wire, paper, cartons, boxes, automobile parts, furniture, glass, debris, leaves, dead and decaying material, human excreta or any refuse of any description or any other thing, matter, or substance which may accumulate in an unsightly, unsanitary, or unsafe manner.~~

902.02 Obstructing sidewalks, bikeways or streets.

- (a) No person, regardless of intent, shall place, deposit, maintain, or use, or cause or permit to be placed, deposited, maintained, or used upon any street, alley, sidewalk, bikeway, ~~as defined in Section 900.03~~, highway, or right-of-way any materials, containers, vending equipment, structures, appliances, furniture, merchandise, bench, stand, sign, or advertising of any kind, or any other

similar device or obstruction except as authorized by the ~~Director~~ director public service and/or their designee, as required by pursuant to Chapter 903 of the Columbus City ~~Codes~~ Code.

- (1) Any person, regardless of intent, who places, deposits, maintains, or uses, or causes or permits to be placed, deposited, maintained, or used upon any street, alley, sidewalk, bikeway, highway, or right-of-way any obstructions as defined in Section 902.02(a), except as authorized by the ~~Director~~ director public service and/or their designee as required by pursuant to Chapter 903 of the Columbus City ~~Codes~~ Code, shall remove such obstructions.
 - (2) In addition to Section 908.02 and any civil and/or criminal penalties set forth in this chapter, upon failure of any person to remove such obstructions as defined in Section 902.02(a), then the removal service may be rendered by the appropriate city agency and the person billed at the current hourly rates of the agency's equipment and personnel.
 - (3) Failure to pay such bill within ten (10) days shall be grounds for revocation of any and all city permits, licenses, performance bonds, and letters of credit issued to or posted by such person and for refusal to issue any new permits or licenses for so long as the bill remains unpaid.
- (b) No person shall knowingly erect, or cause to be erected or permit to remain standing:
- (1) Any porch, portico, veranda, stairs, steps, cellar doors, area, or other projection, extending over or upon the sidewalk, or shared-use path ~~as defined in Section 900.03~~ of any street, alley, or public highway in the city, provided that, the city council may grant the right to construct areaways under sidewalks or shared-use paths upon the condition that they are constructed to the approval of the chief building ~~official~~ inspector;
 - (2) Any house, building, wall, fence, post, pole, rocks, blocks, timbers, curbs, landscaping materials, or other structure in such a manner that any part thereof shall stand or project beyond the line of any lot or parcel of ground into any street, alley, sidewalk, bikeway, highway, or right-of-way. Mailbox supports, street trees as defined in Chapter 912 of the Columbus City Codes and utility poles are not regulated by this section.
- (~~a~~c) No person being the owner of any lot abutting ~~on~~ a street or avenue of the city which is enclosed by a fence shall have the gate at the entrance of such lot from the street or avenue so constructed as to be allowed to swing outward over the street or avenue or the sidewalks or shared-use path unless such gates shall be so constructed and supplied with springs, chain, and weight or other appliances as to automatically close such gates and keep them closed when not in use.
- (~~b~~d) No person shall play at a game of ball upon any street or street park in the city.

902.03 Maintaining improper or unsafe sidewalks, shared-use paths or streets.

- (a) Every owner, occupant, or person having charge of any lot or parcel of land in the city shall cause the paved sidewalk or shared-use path, or any part thereof, in front of and abutting, or to the side or rear of and abutting upon such lot or parcel of land, to be clear of snow and ice each day. If for any cause it shall be impossible to remove all the snow and ice which may adhere to such sidewalk or shared-use path, then every such owner, occupant, or person having charge shall cover such snow or ice as shall remain with such coating of sand or other substance as may be necessary to render travel safe and convenient.
- (b) No person shall do any of the following:
 - (1) Place or deposit snow or ice collected from parking lots, driveways, or any other private property onto a street, sidewalk, shared-use path, alley, or right-of-way; place or deposit snow

-
- or ice collected from driveway entrances or any other location onto a street, shared-use path or sidewalk in such a manner as to impede safe travel.
- (2) Open any door constructed in and as a part of a public sidewalk, shared-use path or street and as a covering over an areaway under such sidewalk, shared-use path or over an entrance way to the basement of a building, or use such opening or entrance way, except between the hours of 6:00 p.m. and 8:00 a.m.
 - (3) Allow cellar doors or any other opening of a similar nature to remain open on any sidewalk or shared-use path of any street or alley unless a substantial railing surrounds the opening or unless there is stationed at such cellar door, trap door, or any other opening of a similar nature a guard or watchman during the time or period of its remaining open.
 - (4) Pave, repave, or repair any sidewalk or shared-use path in the public right-of-way, or cause the same to be done, without first obtaining a permit to do so from the Director ~~director~~ ~~public service and/or their designee~~.
- (c) No person shall construct:
- (1) On any sidewalk, shared-use path, street, or alley any smooth iron doors or coverings of maintenance holes, coalholes, or gratings, or by whatever other name they may be called. When such doors or coverings of maintenance holes, coalholes, or gratings are constructed they shall be of rough corrugated iron on the level with such sidewalk, shared-use path, street, or alley neither higher nor lower than the sidewalk, shared-use path, street, or alley on which they are constructed;
 - (2) Any pipe, stopcock or valve on any sidewalk or shared-use path unless they are constructed so as to conform with the level of the sidewalk or shared-use path neither higher nor lower than the sidewalk or shared-use path on which they are constructed.
- (d) No person shall:
- (1) Remove, displace, destroy, or deface any barrier, marker, sign, obstruction, or light set placed by any person acting under the direction of the ~~director of public service~~ Director or the director of public safety, in or on any public street or alley for the purpose of temporarily closing such street or alley or for the purpose of temporarily prohibiting driving, parking, stopping, or standing of vehicles thereon in connection with the improvement, repair, maintenance, or cleaning of such street or alley, or for any other authorized reason;
 - (2) Drive, park, stop, or stand any vehicle in or upon any street or alley when said street or alley is so marked by any barrier, marker, sign, obstruction or light for the purposes stated in ~~subsection~~ division (d)(1);
 - (3) This ~~section~~ division shall not apply to any person requiring the use of such street or alley so temporarily regulated for access to any premises abutting on the portion of such street or alley so temporarily regulated, when such person shall have obtained a written consent to use the street or alley for such purpose from the ~~officer under whose authority the regulation was established~~ Director.
- (e) The ~~director of public service~~ Director and the director of public safety each is authorized, in their separate official capacity, to temporarily regulate the driving, parking, stopping or standing of vehicles upon any street or alley in the city, when such regulation is required for the purpose of improving, repairing, maintaining or cleaning such street or alley.

-
- (f) No regulation under ~~subsection~~ division (e) shall be effective until and unless the street or alley to be regulated is properly posted by appropriate signs or markers.

902.04 Driveway and ditch pipe installation and maintenance.

- (a) It shall be the duty of every owner of any lot or parcel of land in the city having a driveway crossing a roadside ditch or area ditch, to provide and maintain a driveway pipe of the proper size, material, and at the proper grade to allow free flow of water in the roadside ditch. This responsibility includes, but is not limited to, installing, replacing, resetting, cleaning, and related maintenance of said driveway pipe.
- (b) Every owner, prior to performing said installation or maintenance work, or extending or installing any pipe or conduit for the purpose of enclosing a ditch, shall secure the consent of the ~~director~~ public service and/or their designee, as required by Director pursuant to Chapter 903 of the Columbus City CodesCode. All work involving sewer pipes must conform to all applicable requirements as provided for in of Title 11, Article 3 of the Columbus City Codes Code.

902.99 Penalties.

- (a) Whoever violates any provision of this chapter is guilty of a misdemeanor of the third degree ~~and may be fined not more than five hundred dollars (\$500.00) or imprisoned for not more than sixty (60) days or both~~ except whoever violates Section 902.03(a) is guilty of a minor misdemeanor ~~and may be fined not more than one hundred fifty dollars (\$100.00) (\$150.00).~~
- (b) Strict liability is intended to be imposed for a violation of this chapter. It is an affirmative defense to a charge under Section 902.03(a) that, at the time of the alleged offense, the person charged suffered from physical impairments which caused the person to be incapable of clearing or covering the snow and ice as required by that subsection and was unable to arrange to have another person clear or cover such snow and ice.
- (c) Organizational criminal liability as provided for in City Code Section 2301.23 is intended for violations of this chapter.

Chapter 903 EXCAVATION/OCCUPANCY REGULATIONS

903.01 Director's of Public Service or their designee's approval consent required.

- (a) All ~~public service agencies, companies or corporations,~~ persons and individuals wishing to dig into or open holes, ditches or trenches in the sidewalk, bikeway or roadway or to occupy the right-of-way of any streets, alleys or public ways of the city in order to place, extend or repair therein any pipes, conduits or wires, or for any other reason, shall at least ten (10) working days before proposing or preceding to do so, obtain a permit from ~~the consent of the Ddirector public service and/or their designee.~~ All such permit requests shall be submitted, reviewed, and approved, and all appropriate fees and deposits paid to the city, before such permit consent shall become effective. All such fees shall be credited to the Street Construction Maintenance and Repair Fund and submitted by the Ddirector of Public Service and/or their designee to the Ceity Treasurer. All deposits shall be returned upon completion and acceptance of the work. A record of permits issued ~~such written consent~~ shall be maintained by the Department of public service.
- (b) All ~~public service agencies, companies or corporations,~~ persons and individuals wishing to occupy the public right-of-way of any street, alley, sidewalk, bikeway, public way or paving of the city in order to repair, replace, renovate, extend, refurbish, alter, mark, decorate, install, or maintain any building, structure, surface, pole, conduit, pipe, wires, sign or graphic, cable, sewer or drain structure or building connection of any kind above, near or adjacent to said right-of-way shall, at least five (5) working days before proposing or preceding to do so, obtain a permit from ~~the consent of the Ddirector of public service and/or their designee.~~ All such permit requests shall be submitted, reviewed and approved, and all appropriate fees paid to the city, before such permit consent shall become effective. All such fees shall be deposited by the Ddirector of public service or their designee with the Ceity Treasurer to the credit of the Street Construction Maintenance and Repair Fund. A record of permits issued ~~such written consent~~ shall be maintained by the Department of public service.
- ~~(c) Strict liability is intended for this section.~~

903.02 Supervision of Director of Public Service or their designee.

The Ddirector of public service shall promulgate reasonable rules and regulations to carry out the provisions of this chapter. The Ddirector public service and/or their designee shall supervise and control the work ~~done thereon~~ in the way and manner provided for the digging in and opening up of holes, trenches and ditches in any street, alley or public way of the city, in the sidewalk, bikeway or the roadway or to occupy the right-of-way thereof. The plan and manner of such work shall be as described by the Ddirector of public service and/or their designee.

903.03 New pavement or repavement.

Upon the passage by the city council of any ordinance determining to proceed with the paving of any roadway, no permit will be granted to any person to make any opening in any new pavement or re-pavement of any street or alley, except for the purpose of repairing leaks in pipes, until after three (3) years from the date of the completion of such new pavement or re-pavement.

903.04 Restoration—Traffic obstructions—Damages.

Whenever any person shall have authority, as provided ~~for by a permit issued pursuant to~~ in C.C. Section 903.01, to excavate or dig in or to occupy the right-of-way of any street, alley, sidewalk, bikeway or public way, the person causing such excavation, digging or occupancy to be done shall complete the same such excavation or digging with all possible dispatch. The person shall fill in and cover over such excavation or digging in such manner, and by such time as may be required by the Director ~~public service and/or their designee~~, or shall be liable to the city for the expense thereof, if it be filled in or covered by the city. During the progress of any such work at least one-half (½) of the street or alley shall be kept open and free for the passage of vehicles, except when in the opinion of the Director ~~public service and/or their designee~~ the street or alley must be closed to facilitate the work to be done. The person so causing any such excavation, digging, or occupancy to be done shall be liable for all damages to persons or property which in any way result therefrom.

- (a) Wherever work within the public right-of-way creates an obstruction or hazard to pedestrian or vehicular traffic, temporary traffic control measures shall be installed and maintained in accordance with any maintenance of traffic plans approved by the Director and required by the permit.
- (b) Permit related roadway, and/or travel lane closures shall be reported in accordance with the rules and regulations promulgated by the Director.
- (c) When steel plates are used to protect open excavations they shall be secured and maintained in accordance with the Department's standard drawing 1441, which outlines those requirements. The locations of where steel plates are installed shall be reported in accordance with the rules and regulations promulgated by the Director.

903.05 Restoration regulations.

(a) It is the duty of each and every owner of real estate, and of the agent or lessee of such owner, and of any and all persons ~~and every other person~~ who shall, under pursuant to the authority provided for in CC. Section 903.01, open, excavate or occupy the right-of-way or cause or permit the same, whether under contract with the city or otherwise, any street, alley, sidewalk, bikeway or other public way within the corporate limits, for any lawful purpose whatsoever, immediately upon completion of such work, to cause it to be put back and placed in reasonably close conformity to the condition existing before such work began. This work shall include, but is not limited to the following:

(1) For the purpose of laying or repairing any:

Water pipe for the conveyance of water;

Gas pipe for the conveyance of gas; or

Sewer pipe for the conveyance of drainage or sewerage;

Construction of any kind of sewer or other drain structure;

Electric or cable type conduit of any kind; or

(2) For the purpose of making house connections of any kind whatsoever; or

(3) For placing or repairing any overhead lines or other similar facilities; or

(4) For opening, excavating or occupying the right-of-way, or cause or permit to be opened, be excavated in or to occupy the right-of-way, of any such street, alley, sidewalk, bikeway or other public way, for any lawful purpose whatsoever.

(b) The aforesaid work shall include the proper and thorough compacting and settling of the earth displaced, replacement of backfill, subbase or pavement as required by current city standards and in accordance with the current Construction and Material Specifications of Columbus (CMSC). The top of any such opening shall be laid with the same or nearly the same kind of material(s) as the CMSC permit as composed the surface thereof before such opening and in the same manner and upon the same level as it lay before such opening was made.

(c) All of the aforesaid shall be done before leaving such work, and immediately after the accomplishment of the purpose of such opening or occupancy of the right-of-way, so that the street, alley, sidewalk, bikeway or other public way so opened shall, immediately after such work is done, be placed in reasonably close conformity to the original condition in every respect, as it was before such work was commenced. The duty of so closing up such openings or excavations is also imposed upon any contractor and any officer and upon any and all other persons under whose direction, supervision or oversight such opening is made, or upon whose request, permission or cooperation such opening is made.

(d) It is the duty of the ~~D~~irector of ~~public service and/or their designee~~ to require and see that the provisions of this section are strictly, promptly, fully and carefully carried out and enforced.

(e) All work performed pursuant to this section shall be done in accordance with any applicable permit conditions and restrictions, required inspections, and the rules and regulations for this chapter.

903.06 Protection and lighting required.

(a) Whenever any excavation or trench work or vault grating or other opening in any street, alley, sidewalk, bikeway or public way of the city shall be opened for use, or otherwise, it shall be carefully protected in such manner as to prevent accidents. If opened during nighttime, the opening shall be protected with a yellow steady burning lamp.

(b) No person having charge or control over any vault, area, cellarway or other opening in any street, alley, sidewalk, bikeway or public way of the city, or of the house or building to which the same is attached, shall permit the same to remain open and unprotected, at any time, or to become out of order or repair.;

(c) Such protection, including traffic control devices, shall meet current standards and specifications. All traffic control devices used for maintenance of traffic shall conform to the state of Ohio Department of Transportation's "Manual of Traffic Control for Construction and Maintenance Operations" or similar standards in effect at the time.

903.07 – Annual Blanket Right-of-Way Occupancy Permit.

(a) A holder of a current right-of-way permit issued in accordance with Chapter 910, and the holder's contractor, may apply and obtain separate Annual Blanket Right-of-Way Occupancy Permits. This permit may be used for the purpose of performing the maintenance, installation, and/or removal of the holder's facilities that do not require any excavation within the public right-of-way. Said permits shall be issued on an annual basis and expire at midnight on December 31st of each year.

(b) Annual Blanket Right-of-Way permits may be duplicated and distributed within the permit holder's company as necessary to support aforementioned activities. Copies shall not be distributed to contractors working for the holder. If such permit is necessary for a contractor, that contractor shall obtain that contractor's own permit, which may then be shared throughout that contractor's company as necessary. A

valid permit, in the name of the person at each right-of-way occupancy location, must be available and on display at each job site location.

903.99 Penalty.

(a) ~~Whoever~~ Subject to the provisions of Section 908.02, ~~a~~Any person who violates any provision of this chapter shall be ~~deemed~~ guilty of a misdemeanor of the first degree ~~misdemeanor and fined not exceeding one thousand dollars (\$1,000.00), or imprisoned for not more than six (6) months, or both. Each successive day of~~ Any such violation shall constitute a separate offense ~~on each successive day continued.~~

(b) Strict liability is intended for violations of this chapter.

(c) Organization criminal liability as provided for in City Code Section 2301.23, is intended for violations of this chapter.

Chapter 904 CAFÉ SEATING, BANNERS AND NON-PERMANENT AMENITIES INSTALLED WITHIN PUBLIC RIGHT-OF-WAY

904.0 Right to enforce.

The ~~D~~irector of the ~~public service department~~, the ~~D~~irector of the ~~D~~epartment of ~~P~~ublic ~~S~~safety, the ~~D~~irector of the ~~D~~epartment of ~~D~~evelopment, the ~~H~~health ~~C~~ommissioner and their designees shall have the authority to enforce applicable sections of the Ohio Revised Code and this chapter of the Columbus City Codes (1959) Revised.

904.01 Purpose and scope of chapter.

The purpose of this chapter is to provide for the regulation of privately owned amenities to, or the limited use and occupation of sidewalk or other real property within the public right-of-way in the city of ~~Columbus~~ and to set forth the policies of the city related thereto. Nothing in this chapter shall relieve the applicant from the responsibility to obtain those additional permits required by Columbus City Codes, Chapters 902, ~~Health and Safety~~; 903, ~~Excavation/Occupancy Regulations~~; 905, ~~Sidewalk, Bikeway and Driveway Construction and Repair~~ and 910, ~~Comprehensive Rights of Way~~ or any other Columbus City Code Chapters that might be relative to the installation proposed by the applicant.

904.02 Director of ~~public service and/or their designee's~~ consent required.

- A. Any ~~company, corporation, persons or individuals~~ wishing to use or occupy public right-of-way or other real property within the public right-of-way for placement of private amenities including but not limited to sidewalk or shared-use path seating and/or dining, placement of removable railing or other barricades in conjunction with said seating and/or dining, installation of removable awnings in conjunction with said seating and/or dining, installation of bike racks, flower boxes, movable planters, benches, placement of temporary signage and any other uses authorized in the rules and regulations associated with this chapter must apply for and obtain written consent from the ~~D~~irector of ~~public service and/or their designee~~. Such consent shall be given in the form of a lease for use of public sidewalk or shared-use path or other real property within the public right-of-way, which shall be executed by the ~~D~~irector of ~~public service and/or their designee~~. The city shall review any lease for commercial uses entered into pursuant to this chapter on an annual basis and based upon such review shall determine the suitability of any request for renewal.
- B. Any ~~company, corporation, persons or individuals~~ wishing to install banners or flags within the public right-of-way must apply for and obtain written consent, in the form of an agreement, from the ~~D~~irector of ~~public service and/or their designee~~.
- C. The ~~D~~irector of ~~public service~~ shall promulgate reasonable rules and regulations to carry out the provisions of this chapter.

904.04 Criteria for granting a lease or executing an agreement.

- A. The city shall grant a lease for the use of public sidewalk or shared-use path or other real property within the public right-of-way upon determination that:
1. The public health, safety or welfare will not be negatively impacted upon the granting or renewal of such a lease;
 2. The granting of the lease will be consistent with the policy of the city as set forth ~~fourth~~ in Section 904.01;
 3. The applicant is not delinquent on any taxes or other obligations to the city or county; and
 4. For any proposed location within the boundaries of the downtown zoning district, as established in Columbus City Code Chapter 3359.03, or within the boundaries of any architectural review commission, ~~created by one of the chapters included within Chapters 3319 to 3331~~ as provided for in Title 31 of the Columbus City Codes, or for any location falling under the review authority of the historic resources commission, as established in Chapter 3117, or any location within the boundaries of any recognized area commission established in Chapter 3111 of Columbus City Codes, the applicant has received a certificate of appropriateness from the appropriate commission or commission staff.
- B. An agreement allowing the installation of banners and/or flags shall be granted upon determination that:
1. The public health, safety or welfare will not be negatively impacted upon the execution of such an agreement;
 2. The execution of an agreement will be consistent with the policy of the city as set forth ~~fourth~~ in Section 904.01;
 3. The applicant is not delinquent on any taxes or other obligations to the city or county;
 4. The applicant has followed and conformed to the rules and regulations established by the Greater Columbus Convention and Visitor's Bureau or their successor for the installation of banners and/or flags for any proposed location within that area bounded on the south by Interstate Route 70, the east by Interstate 71, the north by Goodale Boulevard and the west by Grubb Street, and known as the downtown banner/flag program area;
 5. The applicant has followed and conformed to the rules and regulations established by the Columbus Neighborhood Design Assistance Center or their successor for the installation of banners and/or flags for any proposed location within the boundaries of an officially recognized neighborhood commercial revitalization area; and
 6. The applicant has followed and conformed to the rules and regulations established pursuant to Section 904.02 of this chapter for the installation of banners and/or flags for any proposed location not within the boundaries of the downtown banner/flag program or an officially recognized neighborhood commercial revitalization area.

904.05 Fees.

- A. Fees shall be as follows:

-
1. For uses deemed by the city to be private amenities to the public right-of-way including but not limited to flower boxes, planters, and benches a one-time fee of two hundred fifty dollars (\$250.00) per application will be required;
 2. For uses deemed by the city to be commercial in nature including but not limited to sidewalk or shared-use path dining, kiosks, and shoeshine stands an initial fee of five hundred dollars (\$500.00), due at the time the original application is submitted and a fee of fifty dollars (\$50.00) for any subsequent annual renewal will be required. Any material change in the scope or purpose for which the original lease was issued will require a five hundred dollars (\$500.00) fee to process the modification; and
 3. No application or annual fees shall be required for the installation of banners/flags within the public right-of-way.
- B. Fees shall be submitted to the ~~D~~director of public service and/or their designee for deposit into the operating fund. Fees shall be paid by check or money order and shall be made payable to the Treasurer — City of Columbus.;
- C. Fees shall remain reasonable and nondiscriminatory.;
- D. Total revenues generated by such fees shall represent a reasonable allocation of public right-of-way related costs as determined by the ~~D~~director of public service and/or their designee.;
- E. The ~~D~~director of public service and/or their designee must receive all fees before any placement of privately owned amenities to or limited use and occupation of sidewalk or other real property within the public right-of-way of the ~~c~~City of Columbus will be permitted.;
- F. Fees shall not be refundable in the event of any revocation or city required removal of facilities as specified in Sections 904.08 and 904.09 of this chapter.

904.06 Special obligations for those seeking leases.

For those ~~companies, corporations,~~ persons or individuals wishing to lease the public right-of-way for installation of private amenities as described in Section 904.02(A) of this chapter the following obligations shall apply:

- A. The lessee shall restrict use of the leased premises to the patrons, customers and guests of the lessee's establishment when said premises are used for outdoor seating and dining purposes;
- B. The lessee shall not erect or permit any obstructions of a permanent nature to be located within the leased premises;
- C. The lessee shall not erect or permit obstructions of a permanent or temporary nature to be located within the non-leased portion of the public sidewalk or shared-use path or other real property within the public right-of-way;
- D. The lessee shall restrain and prevent its employees, patrons, customers, business invitees, and guests from blocking, obstructing or hindering the flow of pedestrian traffic upon the non-leased portion of the public sidewalk, or pedestrian and bicycle traffic upon the shared-use path or other real property within the public right-of-way;
- E. The lessee shall keep the premises and any adjacent non-leased public sidewalk or shared-use path or other real property within the public right-of-way clean and free of debris;

-
- F. Lessee shall acknowledge acceptance of the premises in "as is" condition with absolutely no warranties, implied or expressed, by the city as to the condition or suitability of the premises for the intended use;
 - G. Lessee shall apply for and receive approval for all building, zoning and any other permits required as a result of the proposed use of public sidewalk or shared-use path or other real property within the right-of-way before any occupation of the public sidewalk or shared-use path or other real property within the public right-of-way may occur; and
 - H. Lessee shall not assign any lease without the written consent of the Director of public service ~~and/or their designee~~. Such consent shall not be unreasonably withheld.

904.99 Penalties.

(a) Whoever violates any provision of this chapter shall be deemed guilty of a misdemeanor of the third degree, ~~and fined not more than five hundred dollars (\$500.00), or imprisoned for not more than sixty (60) days or both.~~ Any such violation shall constitute a separate offense on each successive day continued.

(b) Strict liability is intended for violations of this chapter.

(c) Organization criminal liability as provided for in City Code Section 2301.23, is intended for violations of this chapter.

Chapter 905 SIDEWALK, SHARED-USE PATH, AND DRIVEWAY CONSTRUCTION AND REPAIR

905.01 Purpose.

The purpose of this ~~Chapter code~~ is to protect the health, safety and welfare of all persons by way of preventing and/or abating hazardous sidewalk, shared-use path and driveway approach conditions within the public rights-of-way of the city of Columbus by establishing minimum standards relative to:

- (A) The maintenance and construction of sidewalks, shared-use paths, and driveway approaches within the public right-of-way;
- (B) The control and abatement of hazardous sidewalks, shared-use paths, and driveway approaches within the public right-of-way.

905.02 ~~Definitions.~~ [RESERVED]

~~For purposes of this chapter, the following terms, phrases, words, and their derivations have the meanings set forth herein. When not inconsistent with the context, words in the present tense include the future tense, words in the plural number include the singular number, and words in the singular number include the plural number. The words "shall" and "will" are mandatory and "may" is permissive. Words not defined shall be given their common and ordinary meaning.~~

- ~~(A) "Authorized agent" for the abutting property owner shall mean a contractor having an active valid home improvement contractor's (H.I.C.) license on file with the Department of Building and Zoning Services;~~
- ~~(B) "City" means the City of Columbus, Ohio;~~
- ~~(C) "Director" shall mean the director of the public service department or their designee;~~
- ~~(D) "Owner" means any of the following:~~
 - ~~(1) The owner of record as shown on the current tax list of the county auditor in which the property is located;~~
 - ~~(2) The mortgage holder of record, if any, as shown in the mortgage records of the county recorder in which the property is located;~~
 - ~~(3) Any person who has a freehold or lesser estate in the premises;~~
 - ~~(4) A mortgagee or vendee in possession. "In possession" means someone who evidences charge, care or control of the premises, and includes someone to whom the county sheriff in which the property is located has issued a deed for the premises whether or not the deed has been recorded;~~
 - ~~(5) Any person who has charge, care or control of the premises as agent, executor, administrator, assignee, receiver, trustee, guardian or lessee;~~
 - ~~(6) Any person who holds themselves out to be in charge, care or control of the premises as evidenced by negotiating written or oral lease agreements relative to the premises;~~

~~collecting rents for the premises, performing maintenance or repairs on the premises or authorizing others to perform maintenance or repairs on the premises.~~

~~(E) "Person" means, without limitation, a natural person, the person's beneficiaries, executors, administrators, or assigns, and also includes a corporation, partnership, an unincorporated society or association, or any other type of business or association, including respective successors or assigns, recognized now or in the future under the laws of the state or the city;~~

~~(F) "Right of way" means the surface of and the space above and below the paved or unpaved portions of any public street, public road, public highway, public freeway, public lane, public shared-use path, public way, public alley, public court, public sidewalk, public boulevard, public parkway, public drive and any other land dedicated or otherwise designated for the same now or hereafter held by the city;~~

~~(G) "Bikeway" as defined in 900.03.~~

905.03 Right to enforce.

The Director of ~~Public Service~~, shall have the authority to enforce Columbus City ~~Code~~ Codes Chapter 905.

905.04 Adoption of rules and regulations.

As necessary and appropriate, the Director may promulgate rules and regulations to carry out the express purposes and intent of this chapter. The Director shall promulgate proposed rules and regulations by filing the same with the city clerk for publication in the City Bulletin pursuant to Section 121.05 of Columbus City Codes ~~Code~~.

905.05 Supervision and control.

(a) ~~No person or business organization~~ shall construct, reconstruct, repair, or level any sidewalk, shared-use path, curb, curb & gutter or driveway entrance in the public right-of-way, or easement either by private or public agreement, until after having obtained a written sidewalk, shared-use path, curb replacement, or driveway entrance permit from the Director.

(b) All work shall be performed in accordance with the current Construction and Material Specifications of Columbus (CMSC), the city's current Standard Construction Drawings, and to the satisfaction and approval of the Director. Said CMSC and standard construction drawings shall be available to all members of the public for purchase or viewing within the Department of ~~public service~~ offices during normal business hours.

(c) Construction of or on any sidewalk, shared-use path, curb, curb and gutter, or driveway entrance within the public right-of-way or easement performed contrary to the provisions of this chapter, or the associated rules and regulations of the Director, shall constitute a violation of this code and may be ordered stopped and/or removed by the Director ~~transportation administrator~~. The Director may order replacement of a sidewalk, shared-use path, curb, curb and gutter, or driveway entrance subsequent to such ordered removal. Sidewalk, shared-use path, curb, curb and gutter, and or driveway entrance removal and replacement shall be completed pursuant to the provisions herein within thirty (30) days after receipt of such order.

905.06 Sidewalk, ~~shared-use path~~ and driveway entrance maintenance and repair.

(a) The abutting private property owner ~~of record~~ shall be responsible for the proper maintenance and repair of all sidewalks, ~~shared-use paths~~ and driveway entrances within the abutting right-of-way or easement for any improved or unimproved street, alley, or other public way within the city, which provides access around, in, or to said private property. For driveway entrances, this includes any curb, to the nearest tool joint, constructed as a part of, or to accommodate the driveway entrance. This shall include dropped curb, mountable curb, combination curb and gutter or other curb condition at the street entrance to the approach, as well as any flairs and radii of the driveway approach.

(b) All sidewalks, ~~shared-use walk~~ paths, curb ramps, and driveway entrances shall be constructed, reconstructed, and/or repaired through the use of Portland Cement Concrete except where existing sidewalk is composed of alternate materials that have been previously approved by the Director, as outlined within the city's standard construction drawings, or, as authorized by the Director. All ~~shared-use paths~~ shall be constructed, reconstructed, and/or repaired through the use of either Portland Cement Concrete or hot mix asphalt concrete except where existing ~~shared-use paths~~ are composed of alternate materials that have been previously approved by the Director, as outlined within the city's standard construction drawings, or, as authorized by the Director. Where existing sidewalks or ~~shared-use paths~~ are composed of alternate city approved materials, they shall be replaced in kind unless otherwise authorized by the Director.

(c) In accordance with Chapter 912 of Columbus City ~~Codes Code~~, trees, bushes, nor shrubs located within the public right-of-way or easement may be damaged or removed, including limbs and roots, to accommodate sidewalk, ~~shared-use path~~ or driveway approach construction or repair without the prior approval of the Recreation and Parks Department, ~~in the form of a plant "maintenance" or "removal permit."~~

(d) All work related to the construction, maintenance, or repair of a sidewalk, ~~shared-use path~~, driveway approach, or curb shall be performed in accordance with the permit conditions and restrictions as well as the rules and regulations promulgated by the Director pursuant to Section 905.03.

905.07 Sidewalk specifications—Grade.

(a) Sidewalks shall be constructed so as to conform with the specified locations, lines, grades, and widths on file in the ~~D~~epartment of ~~public service offices~~ and shall generally slope toward the street centerline where ~~practicable practical~~. In no case shall these sidewalks be less than a minimum width of four (4) feet for all streets having a right-of-way width of twenty (20) or more feet, and shall be so located that the nearest edge of sidewalk to the back of the curb or edge of pavement along the street shall not be less than three (3) feet, unless otherwise approved by the Director. When a sidewalk is specified, or permitted, to be placed next to a curb in no case shall it be less than a minimum width of six (6) feet. Public sidewalks associated with this chapter shall be constructed within the existing public right-of-way, so as not to encroach upon private property, unless previously approved by the Director. Where the Director has approved the construction of a public sidewalk outside of existing right-of-way, said approval shall be contingent upon the property owner's granting of additional right-of-way or pedestrian access easement to the city under said sidewalk area. The form of acceptable property rights transfer shall be at the Director's discretion.

(b) The line, grade, and cross-slope of sidewalks and ~~walk~~ ~~shared-use paths~~ shall comply with all requirements of the Americans with Disabilities Act of 1990, and all regulations and amendments promulgated thereto, and the city's standard construction drawings. No depression or lowering of the level or grade of such sidewalks or ~~walk~~ ~~shared-use paths~~ shall be recognized or permitted for the purpose of

making or constructing a driveway or entrance to private or public property or premises bounding or abutting on such street from the roadway thereof except as permitted by an approved driveway entrance.

(c) All sidewalks and/or ~~walk~~ shared-use paths constructed, reconstructed, or repaired at an intersection shall include the construction of an Americans with Disabilities Act of 1990 compliant curb ramp in accordance with the current CMSC, the city's standard construction drawings, and the rules and regulations associated with this chapter.

905.071 Shared-use path specifications—Grade.

(a) Shared-use paths shall be constructed so as to conform with the specified locations, lines, grades, and widths on file in the ~~D~~department of ~~public service offices~~ and shall generally slope toward the street centerline where practicable ~~practical~~. In no case shall these shared-use paths be less than a minimum width of ten (10) feet for all streets having a right-of-way width of thirty-five (35) or more feet, and shall be so located that the nearest edge of sidewalk to the back of the curb or edge of pavement along the street shall not be less than three (3) feet, unless otherwise approved by the Director. When a shared-use path is specified, or permitted, to be placed next to a curb in no case shall it be less than a minimum width of eleven (11) feet.

(b) Public shared-use paths associated with this chapter shall be constructed within the existing public right-of-way, so as not to encroach upon private property, unless previously approved by the ~~D~~irector. Where the ~~D~~irector has approved the construction of a public shared-use path outside of existing right-of-way, said approval shall be contingent upon the property owner's granting of additional right-of-way or access easement to the city under said shared-use path area. The form of acceptable property rights transfer shall be at the ~~D~~irector's discretion.

(c) The line, grade, and cross-slope of shared-use paths shall comply with all requirements of the Americans with Disabilities Act of 1990, and all regulations and amendments promulgated thereto, and the city's standard construction drawings. No depression or lowering of the level or grade of such shared-use paths shall be recognized or permitted for the purpose of making or constructing a driveway or entrance to private or public property or premises bounding or abutting on such street from the roadway thereof except as permitted by an approved driveway entrance.

(d) All shared-use paths constructed, reconstructed, or repaired at an intersection shall include the construction of an Americans with Disabilities Act of 1990 compliant curb ramp in accordance with the current CMSC, the city's standard construction drawings, and the rules and regulations associated with this chapter.

905.075 Curb ramp requirements.

All curb ramps constructed, reconstructed, or repaired shall comply with the Americans with Disabilities Act of 1990 and any subsequent modifications or amendments thereto, current Construction and Material Specifications of Columbus (CMSC), current City of Columbus Standard Construction Drawings, and applicable rules and regulations. In order to maintain a compliant Pedestrian Accessibility Route as defined by the Americans with Disabilities Act of 1990, off-premises public curb ramps and other necessary accommodations including pedestrian pushbuttons shall be required opposite the public curb ramps built or reconstructed by a developer adjacent to the property or by a public agency constructing an improvement. Said off-premises public curb ramps and other necessary accommodations including pedestrian pushbuttons shall be eligible for reimbursement according to the provisions of Section 4307.29(H).

905.08 Permits and fees.

(a) Prior to requesting a driveway entrance permit for ~~all~~ any new commercial or multi-family development driveway entrance(s), or a new single- or two-family residential driveway on any roadway, the applicant shall submit site plans to the Director ~~in accordance with of Columbus City Code~~. The fee for permits to construct, reconstruct, or repair sidewalks or shared-use paths or driveway entrances shall be established by the Director. Such fees shall include the cost to issue, perform necessary inspections, and plan review as needed and required. Such fee shall be charged and collected by the Director and deposited with the City Treasurer to the credit of the development services revenue fund.

(b) All permits herein provided for shall become null and void ninety (90) days from the date of issuance, if not used, and any money paid therefore shall in no case be refunded. No permit shall be issued except to the owner of the abutting property, a contractor holding a valid City of Columbus Home Improvement, or General Contractor's License, and in the case of commercial and multi-family unit (4 units or more) properties, their the property's authorized agent. The Director may refuse to issue any permit when design is not in compliance with the associated rules and regulations of the Department of ~~public service~~, the city's standard construction drawings, and/or standard engineering profession principles, and shall refuse any permit where the Director has not approved the plans for construction of the requested driveway entrance.

905.09 Driveway widths—Compliance.

No single driveway entrance shall exceed thirty-five (35) feet in width at the curb line or edge of pavement without the consent of the Director. Only where traffic conditions, type of vehicle and/or volume of traffic using the proposed driveway entrance warrant may this maximum width be exceeded, but only with the Director's written consent. Where such driveway entrance is built, it must be built as a street intersection in accordance with current standard drawings and CMSC on file in the Department of ~~public service offices~~. Upon proper application and payment of the required fee by the owner of the premises, or the owner's authorized agent, and approval by the Director, a driveway entrance permit in excess of thirty-five (35) feet may be issued. All new driveway entrances shall be constructed so as to maintain a minimum of six-foot of clearance from existing water fire hydrants.

905.10 Maintaining pedestrian and bicycle access.

Where public sidewalks or bikeways exist within the City of Columbus, they may not be eliminated, nor removed for any purpose other than their legal replacement, without the express written consent of the Director.

It is also the intent and purpose of this chapter that pedestrian and bicycle access be maintained at all possible times during sidewalk, bikeway, and driveway approach maintenance and repair operations. Pedestrian and bicycle access and the re-routing of pedestrian and bicycle traffic where access cannot be maintained during maintenance and repair operations shall be performed in accordance with the Department of ~~public service's~~ s rules and regulations relating thereto.

905.11 Code maintenance violation criteria.

(a) No abutting property owner shall allow the condition of the sidewalk, ~~shared-use path~~, and/or driveway approach within the public right-of-way or easement to deteriorate beyond the criteria herein established. Criteria for ordering the replacement or repair of sidewalks, shared-use paths, or driveway approaches shall be any or all of the conditions described as follows:

Offset of one-half (1/2) inch or greater;

Crack which has a gap of greater than one-half (1/2) inch;

An area where there exists a difference in elevation of material of one-half (1/2) inch or greater;

Excessive deterioration, spalling or exposed gravel of one-half (1/2) inch or greater in depth;

Excessive slope caused by a shifting of the sidewalk, shared-use path or driveway approach.

(b) Patching shall not be permitted as a means of eliminating criteria for replacement. The complete removal or leveling of existing concrete shall be required of a concrete panel from joint to joint. If a construction tool joint is not present, then the entire area shall be corrected unless authorized otherwise by the Director. Where offsets, elevation differences, deterioration, and/or spalling exceeds one and one-half (1.5) inches in depth within a sidewalk, shared-use path or driveway approach, and/or where excessive sidewalk or shared-use path cross slope is equal to or greater than ten (10) percent, these conditions shall be considered just cause for emergency barricade and/or repair by the Director, as outlined within Section 9058.1305, Emergency Orders.

905.12 Notice of violation. [RESERVED]

(A) ~~Issuance of Notice of Violation. Whenever the Director determines, or has reasonable grounds to believe, that there exists a condition that violates any provisions or requirements set forth within this chapter, they may issue a notice setting forth the alleged violation(s) and advising the abutting property owner or person having charge that such violation(s) must be corrected.~~

(B) ~~Content of Notice of Violation.~~

(1) ~~All notices of violation, except emergency orders, shall be in writing and shall be served on the abutting owner, from whom action, forbearance or compliance is required;~~

(2) ~~All notices of violation shall identify the sections of this chapter to which the order applies;~~

(3) ~~All notices of violation shall provide a description of the premises where the violations are alleged to exist or to have been committed;~~

(4) ~~All notices of violation shall specify a thirty (30) daytime frame for compliance with the order, except in the case of an emergency order, as described in Section 905.13;~~

(5) ~~All notices of violation shall advise the abutting property owner or person of the right to appeal, within fifteen (15) days of receipt of notice;~~

(6) ~~All notices of violation shall advise the owner and/or responsible party that if the order is not complied with by the time specified, the Director may initiate a civil and/or criminal complaint against the owner and/or responsible party; and/or the Director may, by city personnel or private contractor, cause the violation(s) to be corrected with the cost of such correction(s) to be charged as a lien upon the real estate.~~

(C) ~~Service of Notice of Violation. A notice of violation shall be served upon the abutting owner any permittee person from whom action, forbearance or compliance is required. Such notice shall be served by any one (1) of the following methods:~~

(1) ~~Personal service; or~~

(2) ~~Certified mail; or~~

(3) ~~Publication in a newspaper of general circulation in the county; or~~

-
- (4) ~~Regular mail service to an address that is reasonably believed to be:~~
- (a) ~~A place of residence of the owner, or~~
 - (b) ~~A location at which the owner regularly receives mail; or~~
- (5) ~~Posting the notice of violation on the abutting property, except that if the structure or abutting property is vacant, then the notice shall be posted on the structure or premise and one (1) of the above methods of service shall also be used.~~
- (D) ~~When the notice of violation has been properly serviced, the order shall be effective as to anyone having any interest in the premises whether recorded or not at the time the order was issued, and shall be effective against any subsequent owner of the premises as long as the violation exists and there remains a city record of the order in a public file maintained by the director;~~
- (E) ~~Written or oral acknowledgment by the owner of receipt of a notice of violation shall be evidence that the owner received the notice of violation. An appeal of the notice of violation by the abutting owner pursuant to Section 905.14 shall constitute evidence of written acknowledgment by the owner of service of notice of violation.~~

905.13 Emergency order. [RESERVED]

~~Whenever the Director finds that an emergency exists, as described in Section 905.11, which requires immediate action to protect the health and safety of any person, they may issue an oral or written emergency order reciting the existence of such an emergency and requiring such action as they deem necessary shall be taken to eliminate the emergency. Notwithstanding the other provisions of this code, such emergency order shall be effective immediately and complied with immediately.~~

~~In cases where it reasonably appears that there is imminent danger to the health and safety of any person unless the emergency condition is immediately corrected and if after reasonable attempts to notify the abutting property owner it appears that the abutting property owner will not or cannot immediately correct the condition, the Director may initiate whatever reasonable actions are necessary to eliminate such emergency. These actions may include the temporary barricade of the area, re-routing of pedestrian, bicycle and/or vehicular traffic, or whatever actions are deemed necessary to eliminate the emergency on an interim or permanent basis.~~

~~The Director shall further cause the cost of all such temporary and/or permanent abatement to be billed to the abutting property owner as a municipal lien or to be recovered in a civil suit against the owner and/or responsible party at the current hourly rates of the Department of Public Service's equipment and personnel, or those of its contractual agent, including the cost for materials provided that cannot be reasonably salvaged by the city.~~

905.14 Appeal procedure. [RESERVED]

~~Any persons affected by any notice issued in connection with this chapter may request and shall be granted a hearing before the Property Maintenance Appeals Board on all matters set forth in such notice, provided that:~~

- (A) ~~Such person shall file a written petition requesting such appeal hearing with the Department of Building and Zoning Services, within fifteen (15) calendar days after the notice is served; and,~~
- (B) ~~The petition shall set forth the factual reasons why a particular violation or violations is being appealed.~~

Appeal hearings shall be conducted and the notice of Board findings shall be completed as set forth in the Columbus Housing Code, Chapter 4509.03.

905.15 Prohibition against failure to comply with notice of violation. [RESERVED]

No person shall violate any provision of this Sidewalk, Shared Use Path, and Driveway Construction and Repair Chapter or any rules or regulations promulgated by the Director in accordance with this chapter.

No owner or person having charge or authority over a violation of this Sidewalk, Bikeway and Driveway Construction and Repair Chapter shall fail to comply with a notice of violation or emergency order of this Chapter, or any rules or regulations promulgated by the Director in accordance with this chapter, or obstruct or interfere with the execution of such order, or fail to comply with said notice of violation or emergency order.

No person shall fail to comply within the time frame specified in a notice of violation or emergency order after receiving notice of being in violation of this Sidewalk, Bikeway and Driveway Construction and Repair Chapter, or any rules or regulations promulgated by the Director in accordance with this chapter.

905.16 Procedure upon failure to comply with notice of violation. [RESERVED]

~~Whenever, upon inspection by the Director or their designee, there are reasonable grounds to believe there is a violation of this Sidewalk, Bikeway and Driveway Construction and Repair Chapter which results in the existence of an actual or potential public nuisance or creates conditions that adversely affect the health, safety or welfare of any person, or when notices or orders issued pursuant to this chapter or other notice sections of city codes do not alleviate such public nuisance or condition, the Director or their designee may:~~

~~(A) cause the correction or abatement of any public nuisance or condition by acquiring the necessary labor and materials.~~

~~Upon completion of the work to correct or abate any public nuisance or condition, the Director shall, with respect to each parcel of land, provide City Council with a statement of the charges for the labor and materials used and the fees of the officers who made the service of the notice and return.~~

~~Upon receipt of the statement and approval of City Council, the City Clerk shall make a return in writing to the auditor of the applicable county of such statement that shall be entered upon the tax duplicate of the county for the purpose of assessing these costs.~~

~~(B) cause to be filed a civil complaint, in a court of competent jurisdiction and pursuant to the Ohio Rules of Civil Procedure for injunctive relief seeking abatement of the public nuisance ; or~~

~~(C) cause to be filed a criminal complaint in a court of competent jurisdiction.~~

905.99 Penalty.

~~(a) Notwithstanding any additional civil injunctive action or finding, whoever Subject to the provisions of Section 908.02, aAny person who violates any provision of this chapter shall be guilty of a misdemeanor of the third degree.~~

~~(b) Each successive day such of violation is committed, or permitted to continue, shall constitute a separate offense and shall be punishable as such.~~

~~(c) Strict liability is intended to be imposed for violations of this chapter.~~

~~(d) Organizational criminal liability as provided for in City Code Section 2301.23 is intended for violations of this chapter.~~

**Chapter 906 USE OF PUBLIC RIGHTS-OF-WAY FOR NON-COMMERCIAL EVENTS AND
TEMPORARY COMMERCIAL ZONES**

906.00 Right to enforce.

The Director, the Director of the Department of Public Safety, the Director of the Department of Development, the Health Commissioner and their designees shall have the authority to enforce applicable sections of the Ohio Revised Code and this chapter of the Columbus City Codes.

906.01 Purpose and scope of chapter.

- A. The purpose of this chapter is to provide for the regulation of the use or occupation of all rights-of-way in the city for activities other than those relating to construction, the issuance of right-of-way permits to persons for such use or occupancy, and to set forth the policies of the city related thereto.
- B. A right-of-way permit issued pursuant to this chapter does not take the place of any service permit, franchise, license, or permit which may additionally be required by law, including any required by Chapter 903.
- C. ~~As used in this chapter, "director" shall mean the director of the department of public service or the Director's authorized designee.~~
- D. ~~As used in this chapter, "structure" shall mean any object which is assembled, built, constructed, or erected in a stationary location on the ground that, while not permanently affixed to the ground, is not easily movable including, but not limited to, bandstands, platforms, podiums, tables, and tents.~~

906.02 Director of Ppublic Sservice and/or their designee's approval consent required.

- A. All persons seeking to erect or maintain a structure on the right-of-way of any street, alley, or public way of the city for any non-commercial purpose shall obtain a permit from the Director. the consent of the director. All such permit requests shall be submitted, reviewed and approved by the Ddirector before it shall become effective.
- B. Strict liability is intended for this section.

906.03 Supervision of Ddirector of Ppublic Sservice and/ or designee.

The Ddirector of public service shall promulgate reasonable rules and regulations to carry out the provisions of this chapter. The Ddirector shall have the authority to supervise and control the occupancy of the right-of-way thereof, including the authority to establish permit fees. The time, place, and manner of such occupancy shall be set forth by the Ddirector.

906.04 Revocation.

- A. In addition to any other rights set out in this chapter, the city reserves the right to revoke a right-of-way permit in the event such permittee violates any provision of this chapter or the terms of a right-of-way permit in accordance with the procedures set forth in Section 906.04(B) of this chapter.
- B. In the event that the Director has reasonable cause to believe that a permittee is in violation of the provisions of this chapter, or of the permit, or both, the Director shall issue a written notice of revocation to permittee which shall state the reasons for such action. If permittee remedies all violations within twenty-four (24) hours, the Director may rescind said notice of revocation at the Director's discretion. If said violations create an immediate threat to the health, peace, safety, property, and/or welfare of the public, violations must be remedied within two (2) hours. If permittee does not cure the violations or undertake efforts satisfactory to the Director to remedy the violations, the Director may revoke said permit.
- C. Unless otherwise permitted by the Director or required by law, upon the revocation of a right-of-way permit, all facilities located in the rights-of-way or located upon public property pursuant to such permit shall be promptly removed at the sole expense of permittee.

906.07 Temporary commercial zone closures.

(A) No person shall use any public right of way to establish a temporary commercial zone, as defined in Section 900.082, without first obtaining a temporary commercial zone permit.

(B) In an area zoned residential, no temporary commercial zone permit shall be effective for more than one (1) day without approval from the Director.

(C) In areas not zoned residential, no temporary commercial zone permit shall be effective for more than three (3) consecutive days without approval from the Director.

(D) The Department shall issue a temporary commercial zone permit if the following requirements are met:

(1) The applicant has met the requirements of the temporary commercial zone application and paid the required fees;

(2) The applicant has submitted a petition bearing the signatures of eighty (80) percent of the property owners or tenants, or building managers whose property adjoins the side(s) of the public street affected by the permit. A petition with less than the required signatures may be accepted provided the applicant has demonstrated a good faith effort in attempting to contact the property owners or tenants or building managers who did not sign the petition;

(3) The applicant has executed the indemnity agreement required under Section 909.08;

(4) The applicant has presented proof of current and valid permits or licenses otherwise required for the type of commercial activity proposed to be conducted in the public right of way;

(5) The applicant has agreed to otherwise abide by the relevant rules and regulations regarding such commercial activity;

(6) The applicant is not delinquent on any taxes or other obligations to the city or county; and

(7) The department of public service has made a determination that the public health, safety or welfare will not be negatively impacted upon the granting or renewal of such a permit.

906.08 Indemnification and hold harmless agreement.

(A) The applicant for a temporary commercial zone permit shall agree in writing to hold the city of Columbus, its employees, agents, servants, boards and commissions harmless from liability arising from the issuance of the temporary commercial zone permit and from the conduct of the participants or customers of the temporary commercial zone.

(B) The applicant for a temporary commercial zone permit shall agree in writing to indemnify the city of Columbus, its employees, agents, servants, boards and commissions against all claims of injury or damage to persons or property caused by the negligent acts of the applicant.

906.99 Penalties.

(a) ~~Whoever~~ Subject to the provisions of Section 908.02, ~~a~~Any person who violates any provision of this chapter shall be deemed guilty of a first degree misdemeanor and fined not exceeding one thousand (\$1,000.00) dollars, or imprisoned for not more than six (6) months, or both. Any such violation shall constitute a separate offense, on each successive day continued.

(b) Strict liability is intended for violations of this chapter.

(c) Organizational criminal liability as provided for in City Code Section 2301.23 is intended for violations of this chapter.

Chapter 907 HOUSE NUMBERING

907.01 Manner and system.

- (A) All the business houses and dwellings situated within the corporate limits shall be numbered in the manner according to the system prescribed in this chapter.
- (B) The owner, agent, lessee, occupant, or other person having control of any building in the city upon a street to which street numbers of buildings have been assigned shall cause the proper Aarabic numbers to be placed on and continuously maintained on the fanlight, transom, door, entrance, steps or gate, or conspicuous place on the front of such building in such a manner that the number may at all times be legible and visible from the street pavement in front of such building. If a building stands back more than forty-five (45) feet from the lot line, the number shall be conspicuously displayed at or near the walk, driveway, or common entrance to such building at the street line or a gate post, fence, tree, or post, or other appropriate place so as to be legible and visible from the street pavement. As used in this section "front" means that side of the building which faces the street on which the number of the building or premises on which such building is situated, has been allotted, and that the number shall be displayed on such side of such building or premises.
- (C) No person without just cause shall remove, alter or deface any house number properly assigned and placed on or near a building, nor shall any person without just cause place or retain on any building any number other than the one duly assigned if such additional number could reasonably be mistaken for the assigned street number.
- (D) No person shall negligently fail to install or maintain the proper numbers as required by this chapter.

907.05 Size, style and color of numbers.

The numbers shall be Aarabic, shall not be less than four (4) inches in height and the color of the numbers shall contrast with the color of the surface on which they are mounted, applied or appear and shall be visible and legible from the sidewalk or street. The owner, agent, lessee, occupant, or other person having control of such building may post additional sets of address numbers provided that one (1) set complies with the provisions of this chapter.

907.99 Penalty.

(a) Whoever violates or fails to comply with C.C. 907.01, 907.05 or 907.06 shall be deemed guilty of a minor misdemeanor ~~and fined not exceeding one hundred dollars (\$100.00)~~. Any such violation or failure to comply shall constitute a separate offense on each successive day continued.

(b) Strict liability is intended for violations of this chapter.

(c) Organization criminal liability as provided for in City Code Section 2301.23, is intended for violations of this chapter.

Chapter 908 CIVIL CITATION AND EMERGENCIES ENFORCEMENT

908.00 Authority to Enforce.

The authority to investigate and issue civil citations for violating provisions of Chapters 902, 903, 905, and 906 of this Title shall be vested in enforcement personnel designated by the Director. The Director may promulgate reasonable rules and regulations to carry out the provisions of this chapter.

908.01 Civil Citation and Order to Correct.

A. Issuance of Civil Citation. Whenever the Director determines there exists a condition that violates any provisions or requirements set forth in Chapters 902, 903, 905, or 906, the Director, or designated enforcement personnel, may issue a written civil citation setting forth the alleged violation(s), the assessment of any civil penalties as provided for in section 908.02 (A), or other actions that may be taken by the Director, and ordering the person to whom the civil citation is issued to correct such violation(s).

B. Civil Citation shall contain the following information:

1. The section(s) of the relevant chapter(s) to which the order applies.
2. A description of the premises where the violations are alleged to exist or to have been committed and a description of the violations. If applicable, a permit number shall be included.
3. Payment due date of civil penalties. Payment due date must occur after the right to appeal has expired as provided for in section 908.04.
4. The right to appeal the assessment of any civil penalties in accordance with section 908.04.
5. The assessment of any civil penalties as provided for in section 908.02 (A) and/or other actions that may be taken by the Director pursuant to section 908.03.
6. A statement that failure to appeal the civil citation in accordance with section 908.04, or a failure to pay the civil penalties imposed on or before the due date, shall constitute a waiver of the right to contest the civil citation, shall constitute an admission of violation, and a default finding of civil liability shall be imposed for the civil penalties imposed pursuant to section 908.02 (A).
7. A statement of late penalties as provided for in section 908.02 (B).

The Civil Citation shall be completed and signed by duly designated and authorized enforcement personnel. A copy of the completed civil citation shall be filed and maintained with the Department.

C. Service of Civil Citation. A Civil Citation shall be served upon the person responsible for the alleged listed violation(s). Such citation shall be served by any one (1) of the following methods:

1. Personal service;
2. Certified mail;
3. Posting the civil citation on the site or premises, except that if the site or premises is vacant, then the Civil Citation shall be posted on the site or premises and one (1) of the above methods of service shall also be used.

D. Written or oral acknowledgment by the person of receipt of a Civil Citation shall be evidence that the person received the civil citation. A written appeal by the person also shall be evidence that the person received the Civil Citation.

908.02 Civil Penalties.

A. In lieu of pursuing any criminal violation provided for in Chapters 900-906 and in addition to any other means of enforcement provided for by law, the Director may issue a Civil Citation and assess a civil penalty for a violation of any of the code sections listed below. The fines established by this subsection are imposed as civil penalties for the enforcement and remediation of violations within chapters 902, 903, 905, and 906.

<u>Section</u>	<u>Civil Penalty</u>
<u>Subsection 902.01 (a) & (c)</u>	<u>\$500.00</u>
<u>Subsection 902.02</u>	<u>\$500.00</u>
<u>Subsection 902.03 (b), (c), (d)(1) & (d)(2)</u>	<u>\$1,000.00</u>
<u>Subsection 902.04</u>	<u>\$1,000.00</u>
<u>Subsection 903.01</u>	<u>\$1,000.00</u>
<u>Subsection 903.04</u>	<u>\$1,000.00</u>
<u>Subsection 903.05</u>	<u>\$1,000.00</u>
<u>Subsection 903.06</u>	<u>\$1,000.00</u>
<u>Subsection 904.02</u>	<u>\$1,000.00</u>
<u>Subsection 905.05</u>	<u>\$1,000.00</u>
<u>Subsection 905.06 (b) & (d)</u>	<u>\$1,000.00</u>
<u>Subsection 905.07</u>	<u>\$1,000.00</u>
<u>Subsection 905.08</u>	<u>\$1,000.00</u>
<u>Subsection 905.09</u>	<u>\$1,000.00</u>
<u>Subsection 905.10</u>	<u>\$1,000.00</u>
<u>Subsection 906.02</u>	<u>\$1,000.00</u>
<u>Subsection 906.07</u>	<u>\$250.00</u>

The civil penalties imposed by this section may be enforced and collected by means of a civil action or any other means provided for in these city codes or the Ohio Revised Code.

Each day that any such person continues to violate any of the provisions as provided for in this section shall constitute a separate offense.

B. Late Penalties. Late penalties shall be assessed in accordance with the following schedule:

-
1. If the fines established in subsection 908.02 (A) are after the payment due date listed on the Civil Citation an additional twenty dollars (\$20.00) shall be assessed; and
 2. If the fines established in subsection 908.02 (A) remain unpaid forty (40) days after the payment due date listed on the Civil Citation an additional forty dollars (\$40.00) shall be added to the twenty dollars (\$20.00) assessed under subsection 908.02 (B)(1) for a total additional penalty of sixty dollars (\$60.00).
- C. The fines established by this Chapter are noncriminal. The imposition of civil liability upon the person under this section shall not be deemed a conviction for any purpose. The penalties imposed herein are in addition to other penalties permitted by law.
- C. Strict liability is intended for the violations listed in the table in 908.02 (A).
- D. Nothing in this Chapter shall be construed as altering or limiting the effects of any other section of the city codes, including but not limited to, the impoundment of a vehicle parked, stopped, or standing on public right-of-ways, the criminal penalties imposed by such other code sections, or the ability of a law enforcement officer to enforce those sections.
- G. Notwithstanding any other provision of Chapters 902, 903, 905, or 906, whenever there is a violation of any provision of Chapters 902, 903, 905, or 906, the Director may immediately file a complaint for injunctive relief in an appropriate court of competent jurisdiction.

908.03 Right to Abate Violation.

Upon inspection, whenever the Director determines there are reasonable grounds to believe there is a violation of any of the code sections listed in 908.02 (A), and a Civil Citation has been properly served on the person, the Director may:

- A. Cause litter, waste, or obstruction(s) to be removed from any right-of-way, sidewalk, street or shared use path and may employ the necessary labor to perform the task; and/or
- B. Cause the correction or abatement of any condition which violates any relevant section listed in 908.02 (A) and may employ the necessary labor to perform the task; and/or
- C. Cause appropriate legal action to recover costs against the responsible party where labor was required pursuant to division (A) and (B); and/or
- D. Cause to be filed a civil complaint for injunctive relief seeking abatement of the public nuisance in a court of competent jurisdiction; and/or
- E. Cause to be filed a criminal complaint in a court of competent jurisdiction.

Upon completion of any work to correct or abate any violation listed in 908.02 (A), the Director shall provide City Council with a statement of the charges for the labor and materials used and the fees of the officers who made the service of the Civil Citation and return. Upon receipt of the statement and approval of City Council, the City Clerk shall make a return in writing to the auditor of the applicable county of such statement that shall be entered upon the tax duplicate of the county for the purpose of assessing these costs.

908.04 Appeal to the Director.

Any person receiving a Civil Citation may appeal such citation by filing a notice of appeal with the Department, in writing, on a form and in the manner provided for by the rules and regulations of the Director. The written Notice of Appeal must be received by the Department within fifteen (15) calendar days from the date of service of the Civil Citation. Failure to either pay the assessed civil penalty by the

due date listed on the Civil Citation or submit a Notice of Appeal within fifteen (15) calendar days from the date of service of the Civil Citation shall constitute a waiver of the right to appeal and shall be considered an admission of violation and a default finding of civil liability shall be imposed upon the person for the amount of civil penalties assessed.

A written Notice of Appeal shall include the name, address and telephone number of the appellant, the date of the written notice of appeal, and a statement of intent to appeal. The Director shall convene a hearing on the matter within thirty (30) calendar days of receipt of the Notice of Appeal, except as otherwise provided by this chapter. The Director may grant continuances as deemed necessary.

A. The Director shall designate a hearing examiner. No person shall be employed as a hearing examiner unless the person is an attorney admitted to the practice of law in this state or formerly was employed as a law enforcement officer. The hearing examiner shall not be a city employee.

B. The Director shall maintain a record of the hearing consistent with the Department's records retention schedule. The record may be made by stenographic means or by the use of an audio electronic recording device.

C. Each hearing shall be conducted in such manner as the hearing examiner considers appropriate. Rules regarding the admissibility of evidence shall not be strictly applied in the hearing but all testimony shall be under oath. The hearing examiner is authorized to administer oaths. The hearing examiner shall pass upon the admissibility of evidence, but a party may at the time make objections to the ruling of the hearing examiner and if the hearing examiner refuses to admit evidence, the party offering the same shall make a proffer thereof, and such proffer shall be made a part of the record of such hearing.

D. All parties shall have the right to:

1. Offer and examine witnesses and present evidence in support of their case;

2. Cross-examine adverse witnesses;

3. Proffer evidence into the record if its admission has been denied.

The original civil citation issued pursuant to this Chapter or any true copy of it shall be considered a record kept in the ordinary course of business of the City of Columbus and the Department and shall be prima-facie evidence of the facts contained within.

E. All hearings shall proceed as in a trial of a civil action with the City having the burden of proving, by a preponderance of the evidence, that the person for whom the hearing is being conducted committed the violation(s). Upon agreement of the parties and approval by the hearing examiner, hearings may be conducted based on stipulated facts and briefs of the parties. Each party shall provide the hearing examiner and any other parties a proposed list of witnesses and exhibits to be used by that party at the hearing at least five (5) business days prior to the scheduled hearing, if required by the hearing examiner.

F. All parties shall have the right to appear and be heard in person, or have legal counsel, to present their case.

G. The hearing examiner shall issue a written report within ten (10) calendar days of the hearing. The report shall contain a finding of facts, conclusions of law, and recommendation(s) related to the matter. The report shall be forwarded to the both parties. The Director may adopt or reject the recommendation(s) of the hearing examiner.

H. The decision of the Director shall be considered a final appealable order.

908.05 Emergencies.

In enforcing the provisions of and as related to Chapter 902, 903, 905, and 906:

- A. Whenever the Director finds an emergency exists related to an actual or imminent threat to public health and safety and requires immediate action, the Director may issue an oral or written order. The order shall state the existence of such emergency and require such action as the Director deems necessary to meet the emergency. Notwithstanding the other provisions of this code, such order shall be effective immediately and complied with immediately.
- B. Whenever the Director finds an emergency exists related to an actual or imminent threat to public health and safety that implicates the right way and requires immediate action, the Director may order said right of way to be vacated and/or closed forthwith and that it shall not be reoccupied and/or reopened until the conditions causing the emergency have been abated and the Director has given approval to do so.
- C. Whenever the Director finds an emergency exists related to an actual or imminent threat to public health and safety and requires immediate action, and if after reasonable attempts to notify the person it appears that the person will not or cannot immediately correct the condition, the Director may initiate whatever reasonable actions are necessary to cause the immediate abatement of such emergency condition. The Director shall further cause the cost of such abatement to be billed as a municipal lien or to be recovered in a civil action against the person.

Chapter 909 EMINENT DOMAIN

909.01 Appropriation of property.

Property may be appropriated by the city for any public or municipal purpose, and subject only to the limitations imposed by the Constitution of Ohio, such appropriation shall be made as herein provided. By such appropriation the city may acquire a fee simple title or any less estate, easement, or use as determined to be necessary by city council.

909.02 Passage of resolution of intent.

Whenever it is deemed necessary by the city council to appropriate private property for a public purpose, the city council shall pass a resolution declaring the intention of appropriating the property for a public purpose, defining the purpose of the appropriation, and setting forth a pertinent description of the land and the estate or interest therein desired to be appropriated.

909.03 Service of resolution of intent.

Upon the passage of a resolution under Section 909.02, Columbus City Codes, declaring an intent to appropriate property, the Ceity Attorney shall cause written notice to be given to the owner of, person in possession of, or person having an interest of record in every piece of property sought to be appropriated, or to an authorized agent. Such notice shall be served by Certified Mail, or by personal service by a person designated by the Ceity Attorney, or by residence service by a person designated by the Ceity Attorney. Said person shall certify return of or failure of service to the Ceity Attorney. If such owner or agent cannot be found, notice shall be given by publication once a week for three (3) consecutive weeks in a newspaper of general circulation in the city.

909.04 Ordinance to appropriate—Determination of value.

After service of notice of the resolution of intent to appropriate, the city council may pass an ordinance directing the appropriation to proceed. Except in appropriation actions for the purpose of making or repairing roads, or other public exigencies under Section 19, Article I, Ohio Constitution, which shall be governed by Title 1, Chapter 163, Revised Code, if possession of the property is necessary prior to the assessment of compensation by a jury, city council shall in such ordinance declare the city's intention and necessity to obtain immediate possession of the property appropriated and shall secure the payment of the compensation that might be assessed by a jury by causing the deposit with the Court of Common Pleas of Franklin County, as security, of a sum of money not less than the appraised value of the property, as determined by an independent, qualified appraiser retained by the city, plus sixty (60) percent of such appraised value. That portion of the security deposit designated as the appraised value may be withdrawn by the owner prior to the final verdict. Upon the deposit of such security with said court the city may take possession of and enter upon said property, including the buildings and structures, thereon, for the purposes for which the property was appropriated, and, if buildings or structures are located partly upon the land appropriated and partly upon the adjoining land, so that such buildings or structures cannot be divided upon the line between such lands without manifest injury thereto, the city may enter upon such adjoining land upon which any part of the buildings or structures are located for the purpose of removing said buildings or structures.

909.05 Procedures for structures taken.

If buildings or structures are located upon the land appropriated, or located partly upon the land appropriated and partly upon adjoining land so that such buildings or structures cannot be divided upon the line between such lands without manifest injury thereto, and such buildings or structures are removed before the owner accepts that portion of any deposit representing the appraised value of the property or the jury has fixed the value of the same, the Ceity Attorney, upon notification from the Director of Public Service that such buildings or structures are to be removed, shall cause an appraisal to be made by three (3) persons, one (1) to be appointed by the owner, one (1) by the Ceity Attorney, and one (1) by the Ceounty Auditor. Such appraisal may be used as evidence by either the city or the owner in the trial of the case, but neither the city, nor the owner, shall be bound by such appraisal. The making of such appraisal may be waived in writing by the owner. The Director of Public Service shall cause pictures to be taken of all sides of such building or structure and shall compile a complete description of such structure for the purpose of perpetuating evidence of the nature of such structure which may be presented as evidence in the case by either the city or the owner and to which the owner shall have complete access.

909.06 Structures only partly taken.

Upon passage of an appropriation ordinance as provided in Section 909.04, Columbus City Codes, the Ceity Attorney shall file a complaint with the Court of Common Pleas of Franklin County, which complaint: shall describe each parcel of land or contiguous parcels in a single common ownership, or interest or right therein sought to be appropriated, such as will permit ready identification of the land involved; shall contain a statement of the purpose of the appropriation; shall contain a statement of the estate or interest sought to be appropriated; shall contain the names and addresses of the owners, so far as they can be ascertained; shall contain a statement that the city and an owner have been unable to agree; shall contain a copy of the ordinance of appropriation, or have a copy attached thereto as an exhibit and incorporated into the said complaint; shall contain a prayer for the appropriation, and, if a determination of the appraised value has been made, the complaint shall contain a statement of the appraised value of the property, which appraised value may include damage, if any, to the residue and in addition, where immediate possession is to be taken of the property, a statement of the amount of the additional percentage deposit provided for in Section 909.04 and such amount or amounts shall be deposited with the court to serve either as the value of the property appropriated, and damage, if any, to the residue, or as a security deposit. If no answer is filed by an owner on or before the third Saturday after the return day of the summons or service by publication as provided by state general law the owners of the property appropriated will be deemed to have accepted that portion of the amount deposited equal to or represented by the appraised value, in full compensation for the taking and damages, if any, to the residue, and the title of the property appropriated shall vest in the city, for the purposes for which such property was appropriated. All subsequent proceedings with regard thereto shall be in the manner provided by state general law for the appropriation of property by municipal corporations in this state.

909.07 (Repealed by Ord. 150-66.)

Chapter 922 ~~TEMPORARY COMMERCIAL ZONE PERMIT~~ [Reserved]

922.01 Definitions.

- (A) ~~"Temporary commercial zone" means the closing of one (1) or more parking locations in the public right of way between one (1) or more intersections, while maintaining vehicular traffic access on the street, road, or alley, for the purpose of conducting commercial activity, including mobile food vending.~~
- (B) ~~"Commercial activity" means the ordinary activities of trade and commerce where the profit motive is the primary purpose of the temporary commercial zone. This terminology does not apply to sales of materials which are intended to convey information and ideas, or which espouse causes or beliefs protected by the First Amendment of the U.S. Constitution, whether in the form of books, pamphlets, buttons, bumper stickers or t-shirts.~~

922.02 Authority.

- (A) ~~The director of public service shall promulgate reasonable rules and regulations to carry out the provisions of this chapter. The authority granted to the director to promulgate such rules and regulations shall include the authority to establish permit fees.~~
- (B) ~~The Director of the Public Service Department, the Director of the Department of Public Safety, the Director of the Department of Development, the Health Commissioner, and their designees shall have the authority to enforce this chapter of code.~~

922.03 ~~Temporary commercial zone parking closures.~~

- (A) ~~No person shall use any public right of way to establish a temporary commercial zone, as defined in Section 922.01, without first obtaining a temporary commercial zone permit.~~
- (B) ~~In an area zoned residential, no temporary commercial zone permit shall be effective for more than one (1) day without approval from the director of public service.~~
- (C) ~~In areas not zoned residential, no temporary commercial zone permit shall be effective for more than three (3) consecutive days without approval from the director of public service.~~
- (D) ~~The department of public service shall issue a temporary commercial zone permit if the following requirements are met:~~
- ~~(1) The applicant has met the requirements of the temporary commercial zone application and paid the required fees;~~
 - ~~(2) The applicant has submitted a petition bearing the signatures of eighty (80) percent of the property owners or tenants, or building managers whose property adjoins the side(s) of the public street affected by the permit. A petition with less than the required signatures may be accepted provided the applicant has demonstrated a good faith effort in attempting to contact the property owners or tenants or building managers who did not sign the petition;~~
 - ~~(3) The applicant has executed the indemnity agreement required under Section 922.034;~~
 - ~~(4) The applicant has presented proof of current and valid permits or licenses otherwise required for the type of commercial activity proposed to be conducted in the public right of way;~~
 - ~~(5) The applicant has agreed to otherwise abide by the relevant rules and regulations regarding such commercial activity;~~

-
- ~~(6) The applicant is not delinquent on any taxes or other obligations to the city or county; and~~
 - ~~(7) The department of public service has made a determination that the public health, safety or welfare will not be negatively impacted upon the granting or renewal of such a permit.~~

~~922.04 Indemnification and hold harmless agreement.~~

~~The applicant shall agree in writing to hold the city of Columbus, its employees, agents, servants, boards and commissions harmless from liability arising from the issuance of the temporary commercial zone permit and from the conduct of the participants or customers of the temporary commercial zone.~~

~~The applicant shall agree in writing to indemnify the city of Columbus, its employees, agents, servants, boards and commissions against all claims of injury or damage to persons or property caused by the negligent acts of the applicant.~~

~~922.99 Violations — Penalties.~~

~~Whoever violates any provision of this chapter shall be deemed guilty of a first degree misdemeanor and fined not exceeding one thousand dollars (\$1,000.00), or imprisoned for not more than six (6) months, or both. Any such violation shall constitute a separate offense on each successive day continued.~~

2023 Proposed Code Changes

219.01 - Department of public service established.

There is established a department of public service consisting of a director of public service, ~~two (2)~~ deputy directors of public service, ~~assistant directors of public service~~, the division of traffic management, the division of infrastructure management, the division of design and construction, the division of mobility and parking services, and the division of refuse collection. The department of public service shall perform all lawful functions as may be directed by the mayor or ordinance of council.

219.034 - Division of mobility and parking services.

The division of mobility and parking services is established as a division of the department of public service. The administrative head of the division shall be the ~~assistant director for parking services administrator~~. The division shall have as its primary duties general transportation planning efforts to include bicycle infrastructure analysis, traffic calming and shared mobility. The division of ~~parking services~~ shall ~~have as its primary duties also oversee~~ the administration, operation, enforcement, and management of public parking. The division shall include the parking violations bureau as established by 2150.04 of the Columbus City Code.

919.23 - Traffic.

- (A) No person, except in an emergency, shall repair a vehicle in any park.
- (B) No person shall wash, wax, polish or otherwise clean any vehicle, in any park, except in areas designated for such purposes.
- (C) No person shall operate or park a vehicle on the grass except in designated areas.
- (D) No person shall operate any vehicle with a gross weight greater than eight thousand (8,000) pounds in any park without the permission of the director.
- (E) No person shall operate a snowmobile upon or over any area administered by the department except in those areas so designated.
- (F) No person shall operate a motor vehicle upon the roadways within any park in excess of fifteen (15) miles per hour.
- (G) No person shall operate any vehicle upon the frozen surface of any waterway.
- (H) A violation of division (C) of this section constitutes the commission of a parking infraction to be handled pursuant to and governed by the provisions of Chapter 2150.

2105.28 Shared Mobility Devices

The director of the department of public service is empowered to promulgate rules and regulations for the operation of shared mobility devices within the City of Columbus, including, but not limited to, e-scooters, e-bicycles and bicycles, as well as shared mobility device vendors. Such rules and regulations shall establish procedures for the operation of shared mobility devices, shared mobility device vendors and permit fees, and shall be promulgated according to Section 2105.03.

2150.01 - Definitions.

- (A) "Parking Infractions" means a violation of Section 919.23(C), ~~Section 2105.16~~, division (B) of ~~2131.27~~, Sections 2137.09, 2151.01, 2151.03, 2151.04, 2151.06, 2151.08, 2151.09, ~~2151.10~~, 2151.11, 2151.12, 2151.13, 2151.14, 2151.15, 2151.16, 2151.17, 2151.18, 2151.19, 2151.20, 2151.21, 2151.22, ~~2151.23~~, 2151.25, 2151.26, 2155.02, 2155.05, ~~2155.06~~, or 2157.04.
- (B) "Vehicle" has the same meaning as in Section 2101.51.
- (C) "Court" or "Municipal Court" means the Franklin County Municipal Court, unless specifically identified as another court, in which case it means the specifically identified court.

(D) "Bureau" means the City of Columbus, Ohio, Parking Violations Bureau, unless specifically identified as another bureau, in which case it means the specifically identified bureau.

(E) "Local authority" means every county, municipal corporation, township or other local board or body having authority to adopt police regulations pursuant to the constitution and laws of this State.

2150.02 - Impoundment and immobilization.

(A) The commission of a parking infraction, as defined in division (A) of Section 2150.01 of this chapter, within the City of Columbus shall not be considered a criminal offense for any purpose.

(B) A vehicle involved in three (3) or more parking infractions in which judgments or default judgments have been filed with the Clerk of the Municipal Court pursuant to division (C) of Section 2150.07 of this chapter is subject to impoundment or immobilization by law enforcement officers of the City of Columbus or their agents. Impoundment or immobilization pursuant to this division of this section is permitted without regard to whether the vehicle, at the time of impoundment or immobilization, is legally parked. The owner of a vehicle impounded pursuant to this chapter shall be liable for impoundment fees and storage charges as provided by Section 2107.06 of the Columbus City Code.

(C) A vehicle impounded or immobilized under division B or division D of this section shall be released to the owner upon the owner presenting a valid certificate of title to the vehicle to the violations clerk of the parking violations bureau and upon the owner either paying the fines, penalties, fees and costs due on the parking infractions issued or outstanding or payment of the judgments or default judgments which led to the impoundment or immobilization or posting a bond equal to the amount of said fines, penalties, fees, and costs. In no case, however, shall the owner of a vehicle impounded or immobilized pursuant to this chapter be required to post a bond in excess of one thousand dollars (\$1,000.00) to obtain release of the vehicle. If the vehicle owner posts a bond with the parking violations bureau and requests a hearing, the vehicle shall be released to the owner and a hearing scheduled. The hearing shall follow the procedures provided for in Section 2150.07 of the Columbus City Codes.

(D) Notwithstanding divisions (B) and (C) of this section, a vehicle parked, stopped or standing on a public street, easement, public right-of-ways, or highway in commission of a parking infraction is subject to impoundment.

Impoundment of a vehicle parked, stopped or standing on a public street, easement, public right-of-way, or highway in commission of a parking offense may be ordered, directed, or caused by division of Police or Parking Violations Bureau personnel.

2150.04 - Parking Violation Bureau.

(a) The City of Columbus Parking Violations Bureau is hereby established pursuant to Section 4521.04 of the Ohio Revised Code. The Bureau shall be a section within the division of mobility and parking services within the department of public service. The bureau has jurisdiction over each parking infraction that occurs within the territory of the City of Columbus. The bureau will also issue parking permits for areas established pursuant to Section 2105.21 of this Code. The issuance or renewal of a permit under this section shall not be granted until all outstanding parking infractions under this code are paid in full. Notwithstanding any other provision of law to the contrary, each parking infraction that occurs within the jurisdiction of the bureau and the enforcement of each such parking infraction shall be handled pursuant to and be governed by the provisions of Title 21 of this Code.

(b) The operating costs of the bureau shall be paid by the City of Columbus. The director of public service shall appoint a security manager, hearing examiners and the necessary clerical employees. No person shall be employed as a hearing examiner unless the person is an attorney admitted to the practice of law in this state or formerly was employed as a law enforcement officer.

(c) The fines, penalties, fees and costs established for a parking infraction shall be collected, retained and disbursed by the violations clerk if the parking infraction out of which the fine, penalties, fees and costs arose occurred within the jurisdiction of the bureau. The violations clerk shall issue tickets for parking infractions to law enforcement officers for the City of Columbus and prescribe conditions for issuance and accountability. The fine, penalties, fees and costs collected by a violations clerk for a parking infraction shall be disbursed by the clerk to the City of Columbus.

(d) The director of public service shall have authority to contract with any non-governmental entity to provide services in processing, collecting and enforcing parking tickets issued by law enforcement officers and civil judgments and default civil judgments entered pursuant to this chapter. No contract shall affect the responsibilities of hearing examiners as prescribed in this chapter or the ultimate responsibility of the violations clerk to collect, retain and disburse fines, penalties, fees and costs for parking infractions and monies paid in satisfaction of judgments and default judgment entered pursuant to this chapter.

2150.05 - Answers, procedure.

(A) A person who is personally or constructively served with a parking ticket charging the commission of a parking infraction may answer the charge by appearing personally before the parking violations bureau by mail or online appeal. An answer shall be made within ten (10) days from the date of the infraction, and shall be in one of the following forms:

- (1) An admission that the person committed the parking infraction, by payment of any fine arising out of the parking infraction;
- (2) An admission that the person committed the parking infraction, with an explanation of the circumstances surrounding the parking infraction;
- (3) A denial that the person committed the parking infraction and a request for a hearing relative to the infraction. If the person desires the presence, at the hearing, of the law enforcement officer who issued the parking ticket, the person must request the law enforcement officer's presence in the person's answer.

(B)(1) A person who admits committing a parking infraction shall, and a person who admits committing a parking infraction with explanation may, when the person makes an answer, pay the fine arising out of the infraction admitted to the violations clerk of the bureau.

- (2) A person who admits committing a parking infraction with explanation shall submit evidence to the bureau that explains the circumstances surrounding the parking infraction. The evidence may be submitted in person or, to avoid the necessity of personal appearance, may be sent as affidavits and other documentary evidence by mail or electronic mail. The bureau, when it receives an answer admitting that the person committed a parking infraction with explanation, shall promptly determine whether the explanation mitigates the fact that the person committed the parking infraction and notify the person, in writing, by regular U.S. mail or by electronic mail, of its determination.

If the bureau determines that the explanation mitigates the fact that the person committed the parking infraction, the bureau shall eliminate or reduce the amount of the fine arising out of the parking infraction. If the fine is eliminated or reduced and the person has previously paid the fine, the amount paid in excess of the revised fine shall be returned to the person; if the fine is eliminated or reduced and

the person has not previously paid the fine, the person shall pay only the amount of the revised fine. If the bureau determines that the explanation does not mitigate the fact that the person committed the parking infraction, the person owes the entire amount of the fine arising out of the parking infraction, and if the person has not previously paid the fine, the person shall pay the entire amount of the fine. If a person admits to committing a parking infraction with explanation and the person fails to pay the amount of the fine due within ten (10) days after receiving notice of the bureau's determination, unless the amount due has previously been paid, the bureau's determination and the amount of the fine due shall be considered a judgment and shall be treated as if it were a judgment rendered subsequent to a hearing held pursuant to division (B) of Section 2150.07.

(3) A person who denies the commission of a parking infraction shall be granted a hearing concerning the infraction. The bureau shall set a date for the hearing and notify the person, in writing by regular U.S. mail or by electronic mail, of the date, time, and place of the hearing. The hearing shall be conducted by a hearing examiner of the parking violations bureau in accordance with Section 2150.07.

(C) If a person who is personally or constructively served with a parking ticket charging the commission of a parking infraction fails to timely answer the charge, as provided in division (A) of this section, the parking violations bureau shall issue the proper notifications of infraction pursuant to Section 2150.06, and proceed according to that section. Failure to timely answer a charge may result in the imposition of an additional penalty of fifteen dollars (\$15.00).

(D) The issuance of a parking ticket, the filing of or failure to file answer by a person personally or constructively served with the ticket, the substance of an answer, the payment of any fine, penalty, fee and cost, and any other relevant information shall be entered in the records of the bureau.

2150.10 - Parking infraction fines.

The following fines for parking infractions are hereby established:

Code Section	Violation	Current Penalty
919.23(C)	Parking on Grass in city Park	\$30.00
2105.16	Individual Parking Spaces	\$47.00
2131.27(bB)	Parking Near Emergency Vehicle	\$63.00
2137.09	Lights on Parked Vehicle	\$47.00
2151.01(1)(aA)	Parking prohibited on a sidewalk, shared-use path, curb, or street lawn area between a curb and right-of-way line, except a bicycle	\$55.00
2151.01(1)(aaAA)	Parking - prohibited within 1 ft. of wheelchair ramp	\$55.00
2151.01(1)(bB)	Parking - prohibited within 5 ft. of drive	\$55.00

Code Section	Violation	Current Penalty
2151.01(1)(bb BB)	Obstructing bus loading area	\$63.00
2151.01(1)(c C)	Parking - within an intersection	\$55.00
2151.01(1)(cc CC)	Parking in a loading zone	\$30.00
2151.01(1)(d D)	Parking - prohibited within 10 ft. of fire hydrant	\$55.00
2151.01(1)(dd DD)	Parking in a bike lane	\$55.00
2151.01(1)(e E)	Parking - prohibited on crosswalk	\$55.00
2151.01(1)(f F)	Parking - prohibited within 20 ft. of crosswalk	\$39.00
2151.01(1)(g G)	Parking - prohibited within 30 ft. of stop sign	\$39.00
2151.01(1)(h H)	Parking in or near a safety zone	\$55.00
2151.01(1)(i I)	Parking within 50 feet of railroad crossing	\$55.00
2151.01(1)(j J)	Parking near fire station entrance	\$55.00
2151.01(1)(k K)	Parking near street excavation or obstruction	\$55.00
2151.01(1)(l L)	Double Parking, Standing or Stopping	\$55.00
2151.01(1)(m M)	Parking - prohibited, bridge, viaduct or tunnel	\$55.00
2151.01(1)(n N)	Parking - prohibited within 1 ft. of another auto	\$25.00
2151.01(1)(o)(1) O1	Parking - prohibited, signs, no parking	\$55.00
2151.01(1)(o)(2) O2	Parking - prohibited, signs, no stopping	\$55.00
2151.01(1)(p P)	Parking - prohibited in front of schools	\$63.00
2151.01(1)(q Q)	Parking - prohibited in front of theaters	\$22.00
2151.01(1)(r R)	Parking - prohibited in street or alley 23 ft. or less in width	\$63.00
2151.01(1)(s S)	Parking - prohibited in front of church	\$22.00

Code Section	Violation	Current Penalty
2151.01(1)(t F)	Parking - prohibited in parkway	\$25.00
2151.01(1)(u U)	Parking - prohibited in front of auto mail box	\$25.00
2151.01(1)(v V)	Parking - prohibited on expressway	\$30.00
2151.01(1)(w W)	Parking - prohibited on service road	\$55.00
2151.01(1)(x X)	Parking - prohibited 20 ft. of junction of alley & street	\$55.00
2151.01(1)(y Y)	Parking - prohibited within 10 ft. of bulk refuse container	\$55.00
2151.01(1)(z Z)	Parking prohibited in disability space	\$500.00
2151.03	Parking without 10 ft. clearance	\$25.00
2151.04	Stopping not to obstruct street or crossing	\$39.00
2151.06(a A)	More than 12 inches from curb	\$22.00
2151.06(b B)	Parking facing wrong direction	\$25.00
<u>2151.08(a)</u>	<u>Motor running or brakes not set</u>	<u>\$47.00</u>
<u>2151.09(a)</u>	<u>Parking more than 72 hours</u>	<u>\$30.00</u>
2151.10B	Parking on public property	\$25.00
2151.10C	Parking on private property	\$22.00
<u>2151.08</u>	<u>Motor running or brakes not set</u>	<u>\$47.00</u>
<u>2151.09</u>	<u>Parking more than 72 hours</u>	<u>\$30.00</u>
2151.11	Parking near railroad spur tract	\$22.00
2151.12	Blocking driveway or garage	\$63.00
2151.13	Funeral service parking in front of church or funeral home	\$25.00
2151.14	Parking prohibited for displaying vehicle for sale	\$25.00

Code Section	Violation	Current Penalty
2151.15	Parking limited for displaying advertising	\$22.00
2151.16	Parking limited while offering materials for sale	\$25.00
2151.17	Parking for washing, greasing or repairing	\$25.00
2151.18	Parking in permit parking area	\$50.00
2151.19	Moving vehicle when loading space requested	\$25.00
2151.20	Overtime, truck, bus, boat, trailer or house vehicle	\$30.00
2151.21	Fail to register or display	\$50.00
2151.22	Inoperable motor vehicles on public property	\$30.00
2151.25	Parking in dedicated car-sharing parking space	\$50.00
2151.26	Overtime Parking	\$30.00
2155.02	Meter spaces limited to vehicles only	\$39.00
2155.05	Meter Non-Payment	\$30.00
2157.04	Parking, standing of vehicles prohibited - snow emergency	\$63.00

2151.04 - Obstructing street or crosswalk.

(a) No person shall stop a vehicle in such a way as to obstruct any street, highway, or crosswalk except in case of accident or other emergency or when directed to stop by a police officer. In such cases, the operator shall move ~~on again~~ as soon as possible.

(b) A violation of this section constitutes the commission of a parking infraction pursuant to and governed by the provisions of Chapter 2150.

2151.105 - Unauthorized towing.

(a) Except as provided in Sections 2151.22 ~~and 2151.23~~, no person shall remove or cause to be removed any vehicle from private property unless in conformance ~~with Section 2151.10~~ with respect to removing, or causing to be removed, motor vehicles from private property.

(b) Except as otherwise provided in this division, whoever violates this section is guilty of a minor misdemeanor. If, within one (1) year of the offense, the offender previously has been convicted of or

pleaded guilty to one (1) or more prior violations of this section or a substantially equivalent municipal ordinance, whoever violates this section is guilty of a misdemeanor of the third degree.

2155.04 - Powers and duties of the public service director.

The public service director is authorized and directed to make, modify, change from time to time and promulgate such administrative rules as in the director's discretion shall be deemed necessary to effectuate the provisions of this chapter.

The public service director is hereby authorized to establish, modify, and change from time to time, regulations which set forth the days of the week, hours of the day, and the intervals of time for which parking is permissible, and the funds and information required to complete a parking transaction for parking in individual parking spaces so designated and marked as provided for in Section 2155.01. Such regulations shall be signed by the public service director, filed with the city clerk of the city, and published in the City Bulletin.

The maintenance and repair of parking meters shall be under the supervision and direction of the public service director.

The public service director is further authorized to establish the rates for fees to be charged in the event that parking meters are temporarily removed for construction or other purposes as described in Section 2155.055, in accordance with the guidelines stated therein.

2155.05 - Deposit of funds required; meter non-payment.

(a) Whenever a vehicle shall be parked at a parking meter, as defined in Section 2155.01, during the days of the week and during the hours of the day for which the public service director has established regulations as provided for in Section 2155.04, the person parking such vehicle shall immediately deposit or cause to be deposited the required funds, the correct vehicle information, mobile payment zone number and any other information required to complete a parking transaction, except as provided for in the rules and regulations promulgated pursuant to Section 2105.27. Upon the deposit of such funds, and the placing of such parking meter in operation, the parking space may be lawfully occupied by such vehicle during the period indicated on the parking meter. Any vehicle which fails to deposit the required funds and remains in an individual street or off-street parking space after the prescribed time for parking will be determined to be illegally parked and in violation of the provisions of this chapter. The fact that the vehicle is in an individual street or off-street parking space when the time on the parking meter for the same shows no parking permitted unless a deposit of the required funds is immediately made as herein provided shall be deemed prima-facie evidence of the unlawful parking of such vehicle by its owner. When a disabled designated vehicle is parked in a disabled designated space or any legal available parking space the vehicle shall be permitted to park two (2) hours beyond the legal limits on the meter or applicable parking space but not beyond the designated parking hours or other restricted hours that may apply.

(b) A violation of this section constitutes the commission of a parking infraction to be handled pursuant to and governed by the provisions of Chapter 2150.

2155.055 - Fees for parking meters out of service.

Whenever a parking meter is temporarily removed from service by hooding or by actual removal for later replacement, due to sidewalk repair, construction or other reason, the person or entity requesting such removal shall be required to pay a fee for each meter day that the parking meter is out of service. Such fee is to be determined by and shall not exceed the actual revenue loss to the city. Such actual revenue loss shall be determined by the parking meter rate in effect on the day that the meter is removed from service and shall be equivalent to the revenue amount that the parking meter would

generate if used continuously during the hours of enforcement for every meter day that the parking meter is out of service. ~~A waiver of the above noted requirement shall be granted to downtown special events by the service director upon receipt of satisfactory proof that the following conditions are met:~~

- ~~(1) That the sponsoring organization of a downtown special event be not for profit,~~
- ~~(2) That the function be not for profit,~~
- ~~(3) That the function be open to the public and~~
- ~~(4) That the function be held without admission charge.~~

Should it be necessary to remove and reinstall a parking meter post or otherwise remove a parking meter from service by hooding or by other means and restore the same, an additional fee shall be charged which reflects the cost entailed by the city for such removal and restoration or reinstallation. These fees shall be established by the service director, collected by the director's designee, and deposited in the Mobility Enterprise Fund ~~Parking Meter Program's designated fund.~~

2155.11 – Mobility Debt Retirement - Parking Meter Contribution Fund.

There is hereby created the City Mobility Debt Retirement - Parking Meter Contribution Fund into which City Incremental Parking Meter Receipts shall be deposited in the amounts necessary to maintain a balance of at least one million four hundred thousand dollars (\$1,400,000.00) in such fund, to the extent necessary to satisfy the City's obligations under Section 3.3 of the Cooperative Agreement among the Franklin County Convention Facilities Authority, the County of Franklin, Ohio and the City concerning the acquisition, construction, installation, equipping and financing of a full-service convention center hotel to be located on High Street, in Columbus, Ohio, across from the existing Columbus Convention Center. City Incremental Parking Meter Receipts means the incremental increase of receipts from fees and charges imposed by the City for street and off-street parking meters collected by the City as a result of any increase in rates charged after November 1, 2009.

Parcel Number	Legal Description	Address	District Number	Annexation ID
445-304751	Situated in the State of Ohio, County of Franklin, Township of Mifflin, in Quarter Township 2, Township 1, Range 17, United States Military District, being comprised of all of the 15' private lane, Lots 1 through 3 and Lots 5 and 6 of the subdivision entitled "Bridgeview Estates", of record in Plat Book 24, Page 39, the 15' private lane, Lots 1 through 12 and Lots 14 and 15 of the subdivision entitled "Bridgeview Estates No, 2", of record in Plat Book 27, Page 67, Bridgeview Court, as dedicated by Plat Book 27, Page 67, Bridgeview Drive, as dedicated by Plat Book 24, Page 39 and Plat Book 27, Page 67, those tracts of land conveyed to Kipp Columbus Foundation by deeds of record in Instrument Numbers 201405230064238, 202007160102703, 202010260166995, 202009150137954, 202010190162455, 202010160160988, 202008280127816, 202105040079163 and 202105040079164, and the right of way of Agler Road, as dedicated by deeds and conveyed to Franklin County Commissioners by deeds of record in Official Records 31175012, 30737FI 7, 30452H02, 30737F14, 30086EI 7, 30239B01, 30239B07, 30086FI5, 30239B04 and 30792E01 (all references are to the records of the Recorder's Office, Franklin County, Ohio) .	Agler Rd at Bridgeview Dr	5	AN21-008
420-304746	Situated in the State of Ohio, County of Franklin, Township of Clinton, Quarter Township 3, Township 1, Range 18, United States Military Lands and containing 0.91+/- acres, said 0.91+/- acres being part of Lot IO as numbered and delineated upon the record plat for John M. Pugh's Subdivision of record in Plat Book 4, Page 324, said Lot 10 as conveyed to Yellow Dog Investments, LLC of record in Instrument No. 200603230054617, also being part of Chesapeake Avenue (50') as dedicated upon said record plat, said 0.91 +/-.	1183 Chesapeake Ave	3	AN21-011
445-304750	Situated in the State of Ohio, County of Franklin, Township of Mifflin, in Quarter Township 3, Township 1, Range 17, United States Military Lands, being part of the 0.436 Acre tract conveyed to April M. Williams and Helen J. Williams in Instrument Number 201911010145961, all records being of the Recorder's Office, Franklin County, Ohio.	2540 Johnstown Rd.	4	AN21-013
535-318303	Situated in the State of Ohio, County of Franklin, Township of Madison, and being in Section 15, Township 11, Range 21, Congress Lands, and being part of a 35.075 acre tract as conveyed to James R. Cloyes, C.P.A., LLC in Instrument Number 20121115017 4323, of record in the Recorder's Office, Franklin County, Ohio.	5141 Ebright Rd.	9	AN21-015
445-305940	Situated in the State of Ohio, County of Franklin, Township of Mifflin, and being in Quarter Township 3, Township 1, Range 17, United States Military District, and being all of the remainder of a 4.07 acre tract as conveyed to Niam Stelzer Road LLC in Instrument Number 201704190052755, of record in the Recorder's Office, Franklin County, Ohio.	Stelzer Rd	5	AN21-016

545-307257	Situated in the State of Ohio, County of Franklin, Township of Plain, being part of Section 15, Township 2, Range 16, United States Military Lands and containing 4.8+/- acres of land, more or less, said 4.8+/- acres being all of the remainder of that Original 3 acre tract of land as conveyed to Joshua P. Shremshock and Charmagne P. Shremshock of record in Instrument Number 201602030013391, being all of the remainder of that Original 2.00 acre tract of land conveyed to Eugene T. Carty and Myra L. Carty of record in Official Record 13138111, being part of that 0.134 acre tract of land described as Parcel 7WD and conveyed to the City of Columbus of record in Instrument Number 201304170063417 and being part of that 0.102 acre tract of land described as Parcel 6WD and conveyed to the City of Columbus, Ohio of record in Instrument Number 201205070063774, said 4.8+/- acres.	5068-5100 Warner Rd.	5	AN21-017
433-307255	Situated in the State of Ohio, County of Franklin, Township of Madison, being located in Section 12, Township 11, Range 21, Congress Lands East of the Scioto River, being all of Lot 12 of Mack-Ann Subdivision, of record in Plat Book 29, Page 47, a portion of said Lot 12 described in a deed to 4526 Gender, LLC, of record in Instrument Number 202106280112970 and being all of that 0.041 acre right-of-way parcel, known as Parcel 61-WD, described in a deed to Franklin County Commissioners, of record in Instrument Number 200308010243365, all records referenced herein are on file at the Office of the Recorder for Franklin County, Ohio.	4526 Gender Rd.	9	AN21-018
255-307292, 255-3	Situated in the State of Ohio, County of Franklin, Township of Sharon, and being in Quarter Township 2, Township 2, Range 18, United States Military Lands and including all of Lot Number Twenty-Six (26), the east one half of Lot Number Twenty-Eight (28), the east one half of Lot Number Twenty-Nine (29), a northerly portion (1'x22') of Lot Number Thirty (30) and the north half of a Twenty Feet (20') Wide Unnamed Alley of Henry C. Johnson's Second Addition to the Town of Flint, as the same are numbered and delineated upon the recorded plat thereof, and as recorded in Plat Book 2, Page 57, and including all of the 0.34 acre parcel (APN 250-002545) and the 0.12 acre parcel (APN 250-002538) as conveyed to Christopher Jacobs in Instrument Number 202002210026351, with all record references herein cited being of the Franklin Recorder's Office, Columbus, Ohio.	155 Park Rd	1	AN21-019
535-307599, 535-3	Situated in the State of Ohio, County of Franklin, Township of Madison, lying in Section 10, Township 11, Range 21, and being all of a 11.904 tract conveyed to Strait Real Estate LLC, 1 Ltd., (Parcel no. 180-005243-00), as recorded in Instrument Number 199706130022562, and part of a 22.3197 acre tract, and all of those 3.000, 1.348, and 0.995 acre tract as conveyed to Strait Real Estate LLC, 1 Ltd, (Parcel No. 180-000974-00), as recorded in Instrument Number 199705230006729, and Official Record Volume 33276, page B14, and part of a 0.97 acre parcel as conveyed to Franklin County Commissioners, as recorded in Instrument Number 201606020069432, all references being to those of records of the Recorder's Office, Franklin County, Ohio.	5200 Winchester Pike	9	AN22-001

420-307999, 420-3	Situated in the State of Ohio, County of Franklin, Township of Clinton, lying in Quarter Township 3, Township 1 North, Range 18 West, United States Military District, being over Lots 3 and 4 of that subdivision titled "J.O. Lisle Subdivision" of record in Plat Book 5, Page 431, and being comprised of part of that 1.547 acre tract conveyed to Livingston Limited, Inc. by deed of record in Official Record 3376020, part of that tract conveyed to Livingston Limited, Inc. by deed of record in Deed Book 312, Page 162, and Official Record 02525F03, part of that 4.837 acre tract conveyed to Storage Equities/PS Partners III-Mid-Ohio by deed of record in Official Record 9989H03, and that part of that 0.366 acre tract conveyed to City of Columbus by deed of record in Instrument Number 200408230196801 (all references are to the records of the Recorder's Office, Franklin County, Ohio).	824-880 Kinnear Rd	3	AN22-002
600-307601	Situated in the State of Ohio, County of Franklin, Township of Blendon, Quarter 1, Township 2, Range 17, United States Military Lands, and being part of that 0.97 acre tract as described in a deed to Thomas J. Hemmert and Jacqueline S. Hemmert, of record in Official Record 15417, Page C14 (all records referenced herein being to those located in the Recorder's Office, Franklin County, Ohio), and being 0.805 acre more.	4590 Central College Rd	5	AN22-003
512-309018	Situated in the State of Ohio, County of Franklin, Township of Hamilton, being part of Section 1, Township 3 North, Range 22 West, Matthew's Survey of Congress Lands East of Scioto River being part of a 9.308-acre tract of land described to Columbus Regional Airport Authority, aka: The Columbus Regional Authority in Instrument Number 200808190126159, part of a 14.716-acre tract of land described to Columbus STS LLC in Instrument Number 201907260092777.	London Groveport and Shook Rd.	8	AN22-004
245-308003	Situated in the State of Ohio, County of Franklin, Township of Prairie, Virginia Military Survey Number 2988 and being out of that tract of land as conveyed to Pennsylvania Lines LLC, of record in Instrument Number 200212180325195, now known as Norfolk Southern Railway Company, successor by merger, in Instrument Number 200710260186473 and being Franklin County Ohio Auditor's PID: 241-000038 and a 0.048 acre tract of land known as 1-WDV2, as conveyed to the City of Columbus, Ohio of record in Instrument Number 201809060120670, all deed references are on record at the Recorder's Office of Franklin County, Ohio.	Trabue Rd.	2	AN22-005
420-308002	Situated in the State of Ohio, County of Franklin, County of Clinton and being in Quarter Township 3, Township 1, Range 18 in the United States Military District, and being 0.45± acres of the remainder a 0.528 acre tract as conveyed to Evan Davis in Instrument Number 200002220034512.	Chambers Rd	3	AN22-006

Situated in the State of Ohio, County of Franklin, Township of Blendon, Township 2, Quarter Township 4, Range 17 of the United States Military Survey and containing 23.3+/- acres of land, more or less, said 23.3+/- acres being part of a tract of land conveyed to Capitol City Baptist Church in Deed Book 3641, Pg. 64, being part of a 0.820 acre tract of land conveyed to the State of Ohio of record in Official Record 29244, Page G 15 and described as Parcel 22 WV, being all of a 0.515 acre tract of land conveyed to the State of Ohio of record in Official Record 29244 and described as Parcel 23 WV, Page 015, being part of a 5.970 acre tract of land conveyed to the State of Ohio of record in Deed Book 2919, Page 89 and described as Parcel 114 WL, being all of a 0.896 acre tract of land conveyed to the State of Ohio of record in Deed Book 2993, Page 204 and described as Parcel 115 WL, being all of a 0.892 acre tract of land conveyed to the State of Ohio of record in Deed Book 2993, Page 204 and described as Parcel 115 WD, being part of a 2.556 acre tract of land conveyed to the State of Ohio of record in Deed Book 2926, Page 346 and described as Parcel 116 WL and a part of a 0.415 acre tract of land conveyed to the State of Ohio of record in Deed Book 2993, Page 196 and described as Parcel 117 WL and being part of a 0.670 acre tract of land conveyed to the State of Ohio of record in Deed Book 2993, Page 196 and described as Parcel 117 WD, said 23.3+/- acres.

600-318304, 600-318304

5442 Sunbury Rd.

5

AN22-007

Situated in the State of Ohio, County of Franklin, Township of Madison, being part of the Southeast Quarter of Section 14 and the Southwest Quarter of Section 13, Township 11, Range 21, Congress Lands East of the Scioto River, being part of an original 80 acre tract of land (Parcel I) and part of an original 86.66 acre tract of land (Parcel 11) conveyed to Harriet S. B. Levin of record in Official Record 12425 H13, being part of a 1.359 acre tract of land conveyed to the City of Columbus, Ohio of record in Official Record 19645 J05, being part of a 0.295 acre tract of land conveyed to Franklin County Commissioners of record in Instrument Number 201507090092987, being part of an 11.050 acre tract of land conveyed to Franklin County Commissioners of record in Instrument Number 201601130004887, being all of a 0.454 acre tract of land conveyed to Franklin County Commissioners of record in Instrument Number 202002260028294, all references being of record in the Recorder's Office, Franklin County, Ohio.

433-309017

5700 Winchester Pike

9

AN22-008

	Situate in the State of Ohio, County of Franklin, Prairie township, being in Virginia Military Survey Numbers 5106, 5742 and 9221 and also being all of Parcels 1, 2, 3, 4, 5, 6, and a portion of Tract 1 as all are conveyed to Luther E. Kaderly, Trustee of the Luther E. Kaderly Trust dated November 19, 1992, and Marie E. Kaderly, Trustee of the Marie E. Kaderly Truест dated November 19, 1992 in Official Record 21723, Page A01, all of a 0.6334 acre tract as conveyed to Matthew J. Kaderly and Molly Jo Rieder in Instrument Number 200812170180400, all of a 2.672 acre tract {Tract 1} and all of a 2.427 acre tract {Tract 2} as both are conveyed to Julia G. Steward in Instrument Number 201001200006996, a 1.9937 Ac. (30-WD) as conveyed to Franklin County Commissioners in Official Record 25690, Page E17, a portion of Galloway Road as dedicated in Plat Book 25, Page 43, a 0.1017 Ac. (26-WD) and a 0.0201 acre tract (26-WDI) as conveyed to Franklin County Commissioners in Official Record 25819, Page H19, a portion of a 4.7749 acre tract (25-WD) as conveyed to Franklin County Commissioners in Official Record 25166, Page H04, a portion of Hall Road as dedicated in Plat Book 101, Page 54.	6410 Old Hall Rd	6	AN22-009
246-317167, 246-317166	Situated in the State of Ohio, County of Franklin, Township of Hamilton, being in Sections 11, Township 3, Range 22, Congress Lands East of the Scioto, containing 37.45+/- acres of land, more or less, said 37.45 +/--acres being part of that 38.671 acre tract as conveyed to DRCS Rail-Site 8, LLC of record in Instrument Number 202110190189521.	1200 Vause Rd.	8	AN22-011
512-317155	Situated in the State of Ohio, County of Franklin, Township of Franklin, Virginia Military Survey No. 422 and containing 0.47+/- acres, said 0.47+/- acres being all of that 0.471 acre tract of land as conveyed to Green Lawn Cemetery of record in Instrument No. 202103230052574, part of that 1.164 acre tract of land described as Parcel I OWD and conveyed to the City of Columbus, Ohio of record in Instrument No. 1998111002885555 and also being part of Lot I of William L. Miners Subdivision of record in Plat Book 2, Page 180, said 0.47+/- .	766 Greenlawn Ave	7	AN22-012
146-317157	Situated in the State of Ohio, County of Franklin, Township of Franklin and Virginia Military Survey Number 420, and being a portion of the combined 22.648 acre (Deed) parcel (APN 140- 000289-00) as conveyed to Harmon Avenue LLC in Instrument Number 199803020047176, with all record references herein cited being of the Franklin Recorder's Office, Columbus, Ohio.	1790 Harmon Ave	7	AN22-015
146-317156	Situated in the State of Ohio, County of Franklin, Township of Plain, being in Section 2, Township 2, Range 16, United States Military Lands and containing 9.81+/- acres, said 9.81+/- acres being part of that 5.017 acre tract of land as conveyed to Jeff D. Miller and Tina M. Miller of record in Official Record 5283, Page A06 and part of that 5.012 acre tract of land as conveyed to Mark M. Sowle and Lesley A. Sowie of record in Instrument No. 200404130081712, said 9.81+/-.	6915 Harlem Rd.	5	AN22-014
220-001878				

220-002126	Situated in the State of Ohio, County of Franklin, Township of Plain, being part of Section 6, Township 2, Range 16, United States Military Lands and being part of that 5.001 acre tract of land as conveyed to Aleks and Natasha Babamovski in Instrument Number 201710260149962, said 4.8± acres	5142 Central College Rd.	5	AN22-017
220-000183	Situated in the State of Ohio, County of Franklin, Township of Plain, being part of Section 6, Township 2, Range 16, United States Military Lands and being part of that 3.00 acre tract of land as conveyed to Steven L. Dunbar and Cindy L. Ward in Official Record 16550E06 & Official Record 16751C09, said 2.9± acres	5180 Central College Rd.	5	AN22-018
190-000391	Situated in the State of Ohio, County of Franklin, Township of Mifflin and being in Quarter Township 3, Township 1, Range 17, United States Military Lands, and being a portion of the 0.634 acre (Deed) parcel (APN 190-000391-00) as conveyed to QSI, Properties, LLC in Instrument Number 202206060084440, with all record references herein cited being of the Franklin Recorder's Office, Columbus, Ohio	2594 Johnstown Rd.	4	AN22-021
110-005899, 110-000545	Situated in the State of Ohio, County of Franklin, Township of Blendon, Range 17, Township 2, Quarter township 1, United States Military Lands and being all of that 5.17 acre tract of land as conveyed to Jon- David Charlton and Jodi M. Charlton, of record in Instrument Number 201411040146346, and being Franklin County Ohio Auditor's PIO: 110-001001, part of that 16.602 acre tract as conveyed to Eugene L. Hollins and Katherine H. Beach, of record in Instrument Number 201710250149384, and being Franklin County Ohio Auditor's PIO: 110-005.398, part of that 36. 5 acre original tract of land as conveyed to Earl T. Yeager and Stephanie Yeager, of record in Official Records 02553J05, and being Franklin County Ohio Auditor's PIO: 110-000147, part of that 5.01 acre tract of land as conveyed to Barbara V. Prindle and Gail Elizabeth Vawter, Co-Trustees, of record in Instrument Number 202110270195953, and being Franklin County Ohio Auditor's PIO: 110-005899, all deed references are on record at the Recorder's Office Franklin County, Ohio	Cubbage Rd.	5	AN22-022
110-000545	Situated in the State of Ohio, County of Franklin, Township of Blendon, being in Quarter Township 3, Township 2 North, Range 17 West, United States Military Lands, and being parts of Lots 3 & 4 of the Partition and Subdivision of Cyrus P. Denune's Estate as recorded in Plat Book Volume 10, page 309, (all records herein referenced are to the records of Franklin County, Ohio Recorder's office unless otherwise stated) and being all of that Parcel 5 as conveyed to Wayne M. Post, Trustee under the Wayne M. Post Trust Agreement dated the 13th day of September, 2013, his successors and assigns, by the instrument filed as Instrument Number 201310310183529 and being known as Franklin County Auditor's Parcel number 110-000545	4380 Westerville Rd.	5	AN23-002

250-004731	Situated in the State of Ohio, County of Franklin, Township of Sharon, and being all of lot 1324 of Mount Air No. 2, as shown and delineated in Plat Book 19, Page 21, and being conveyed to Michael and Linda McGaughey, by deed of record in Instrument Number 201111280154150	Edgecliff Dr	1	AN23-004
250-004734	Situated in the State of Ohio, County of Franklin, Township of Sharon, and being all of lot 1321 of Mount Air No. 2, as shown and delineated in Plat Book 19, Page 21, and being conveyed to Michael J. and Linda S. McGaughey, by deed of record in Instrument Number 201512290181753	Edgecliff Dr.	1	AN23-005
160-002099	Situate in the State of Ohio, County of Franklin, Township of Jackson, in Virginia Military Survey #1389, being all of the 0.768 Acre tract conveyed to Jack E. and Ruth M. Martin in Deed Book 2804, Page 643 and part of the 0.559 Acre tract conveyed to City of Columbus in Instrument Number 1998031800623 73, all records being of the Recorder's Office, Franklin County, Ohio	1874 Demorest	6	AN23-008
181-001379	Situated in the State of Ohio, County of Franklin, Township of Madison, in the northwest quarter of Section 14, Township 11, Range 21, Congress Lands, being part of that 64.743 acre tract of land conveyed to Bachman Farm, Ltd. by deed of record in Instrument Number 202303220027313 (all references are to the records of the Recorder's Office, Franklin County, Ohio). Situated in the State of Ohio, County of Franklin, Township of Madison, in the northwest quarter of Section 14, Township 11, Range 21, Congress Lands, being all of that 30. 702 acre tract of land conveyed to Bachman Farm, Ltd. by deed of record in Instrument Number 202303220027313 (all references are to the records of the Recorder's Office, Franklin County, Ohio)	5601 Winchester Pike	9	AN23-011

City RFPs, RFQs, and Bids

THE CITY BULLETIN
BIDS WANTED - PURCHASING OFFICE AND OTHER DIVISIONS

CITY OF COLUMBUS FORMAL BID OPPORTUNITIES ARE UPDATED DAILY AT :

Each proposal shall contain the full name and address of every person, firm or corporation interested in the same, and if corporation, the name and address of President or Secretary.

EQUAL OPPORTUNITY CLAUSE: Each responsive bidder shall submit, with its bid, a contract compliance certification number or a completed application for certification. Compliance with a provision of Article I, Title 39, is the condition of the contract. Failure to comply with this Article may result in cancellation of the contract.

WITHHOLDING OF INCOME TAX: All bidders are advised that in order for a contract to bind the city, each contract must contain the provisions found in Section 361.34 C.C.C. with regard to income taxes due or payable to the City of Columbus for wages, salaries and commissions paid to the contractor's employees as well as requiring those contractors to ensure that subcontractors withhold in a like manner.

LOCAL CREDIT: In determining the lowest bid for a contract the local bidder credit will not be applied.

FOR COMPLETE SPECIFICATIONS ON ANY OF THE FOLLOWING BID PROPOSALS PLEASE VISIT [HTTPS://COLUMBUSVENDORSERVICES.POWERAPPSPORTALS.COM/](https://columbusvendorservices.powerappsportals.com/).

THE CITY BULLETIN
BIDS WANTED - PURCHASING OFFICE AND OTHER DIVISIONS

BID OPENING DATE - 8/5/2023 1:00:00 PM

RFQ025547 - Upfitting Dual Partitions for Ford Explorer

1. Provide the following equipment and installation for 1 city of Columbus vehicle with the following items 2. Setina item number PK0316EPL202ND #12VS coated poly carb partition or equivalent. 3. Setina item number 2100SET #10VS RP coated poly partition part# PK0355EPL20TM or equivalent. 4. Installation of front and rear partition

BID OPENING DATE - 8/7/2023 1:00:00 PM

RFQ025531 - Sumo tank fittings

RFQ025568 - DPU/HR - DESK (McHORMLEY)

THE CITY BULLETIN
BIDS WANTED - PURCHASING OFFICE AND OTHER DIVISIONS

BID OPENING DATE - 8/8/2023 9:00:00 AM

RFQ025556 - Refuse - Vinyl rolls for Gerber printer

Gerger Perma Grip Film rolls - 15 x 50yds. Item number AP75517-50Y

RFQ025557 - Refuse - Gerber foils and foil caddies

12 Black Gerber Color spot color foils, Black, 91m, EDGE FX and 3 Gerber EDGE FX foil caddies - single units.

RFQ025558 - Refuse - metal cabinet w/feet for warehouse

Metal storage cabinet, locking w/feet.

BID OPENING DATE - 8/8/2023 2:00:00 PM

RFQ025408 - Mentel Golf Course Clubhouse Exterior Improvements

The City of Columbus (hereinafter "City") is accepting bids for the Mentel Golf Course Clubhouse Exterior Improvements (PID 1092) project, the work for which consists of the repair of structural trusses and cupolas, replacement of exterior lighting and door hardware, painting and sealing, and other such work as may be necessary to complete the contract, in accordance with the drawings, technical specifications, plans and City of Columbus Construction and Material specifications set forth in this Invitation For Bid (IFB). The Mentel Memorial Golf Course Clubhouse is located at 6005 Alkire Road, Galloway, OH 43119 (this is under City of Columbus jurisdiction). WHERE & WHEN TO SUBMIT BID Bids will be received by the City of Columbus, Department of Recreation & Parks, at www.bidexpress.com until August 8, 2023 at 2:00 P.M. Eastern Time. DRAWINGS AND TECHNICAL SPECIFICATIONS Drawings and technical specifications are available as separate documents at www.bidexpress.com. Drawings and technical specifications are contract documents. NOTICE TO PROCEED/CONTRACT COMPLETION The City anticipates issuing a notice to proceed on or about October 2023. All work is to be complete by April 31, 2024. QUESTIONS CONCERNING THE BID DOCUMENTS OR PROJECT Questions pertaining to the drawings, plans, specifications, IFB, and/or other contract documents must be submitted in writing to the Department of Recreation & Parks by email to cmscannell@columbus.gov through August 2, 2023 at 5PM. No phone calls will be accepted.

THE CITY BULLETIN
BIDS WANTED - PURCHASING OFFICE AND OTHER DIVISIONS

BID OPENING DATE - 8/9/2023 10:00:00 AM

RFQ025372 - Roadway - Livingston Ave - Alum Creek Trail to James Rd

1.1 Scope: The City of Columbus, Department of Public Service is receiving proposals until August 9, 2023 at 10:00 A.M. local time, for professional services for the Roadway - Livingston Avenue - Alum Creek Trail to James Road project. Proposals are being received electronically by the Department of Public Service, Office of Support Services via Bonfire at <https://columbus.bonfirehub.com/login>. This is a joint project with the City of Bexley and involves the preparation of preliminary engineering documents and detailed design plans for the segment of Livingston Avenue from the Alum Creek Trail to James Road. Improvements to Livingston Avenue include replacement of the existing traffic signals at the intersections of College Avenue, Roosevelt Avenue, and Kenwick Road; replacement of sidewalk along both sides with shared use paths; modification to the existing pavement to remove the Berwick connection from the intersection at Berwick Boulevard and College Avenue; street lighting upgrades; and addition of landscaped medians., and other such work as may be necessary to complete the contract, as set forth in this Request for Proposals (RFP). All questions concerning the RFP are to be sent to capitalprojects@columbus.gov. The last day to submit questions will be specified in the RFP; phone calls will not be accepted. Responses will be posted on Bonfire at <https://columbus.bonfirehub.com/login> as an addendum. A pre-proposal meeting will not be held. Notice of published addenda will be posted on the City's Vendor Services web site and all addenda will be posted on Bonfire at <https://columbus.bonfirehub.com/login>. The selected Consultant shall attend a scope meeting anticipated to be held on/about two weeks after proposals are due. The projected scope date will be specified in the RFP. If the Project Manager is not available, the Consultant may designate an alternate to attend in their place. 1.2 Classification: All proposal documents (Request for Proposal, reference documents, addenda, etc.) will be available for review and download on Bonfire at <https://columbus.bonfirehub.com/login> after the RFP is advertised. Firms must meet the mandatory requirements stated in the RFP for a proposal to be considered for contract award. 1.3 Bonfire: If you do not have an account with Bonfire and you would like to review project information or submit a proposal, you will need to register for an account. Go to <https://columbus.bonfirehub.com/login> in order to sign up. 1.4 City of Columbus MBE/WBE Program: This project is subject to the requirements of the City's MBE/WBE Program. The MBE/WBE goal assigned to this project is 20.0%.

BID OPENING DATE - 8/10/2023 11:00:00 AM

RFQ025263 - SWAT Tactical Gear UTC

1.0 SCOPE AND CLASSIFICATION 1.1 Scope: This proposal is to provide the City of Columbus with a Universal Term Contract (blanket type) to purchase Tactical Gear to be used by the SWAT Unit. The proposed contract will be in effect through March 31, 2026. 1.2 Classification: The successful bidder will provide and deliver tactical gear, body armor, and related items. Bidders are required to show experience in providing this type of material and/or services as detailed in these specifications. 1.2.1 Bidder Experience: The offeror must submit an outline of its experience and work history in these types of materials and/or warranty service for the past five years. 1.2.2 Bidder References: The offeror shall have documented proven successful contracts from at least four customers that the offeror supports that are similar in scope, complexity, and cost to the requirements of this specification. 1.3 Specification Questions: Questions regarding this bid must be submitted on the Vendor Services portal by 11:00 am on July 10, 2023. Responses will be posted on the RFQ on Vendor Services no later than July 13, 2023 at 11:00 am. 1.4 For additional information concerning this bid, including procedures on how to submit a proposal, you must go to the City of Columbus Vendor Services web site at <http://vendors.columbus.gov/sites/public> and view this bid number.

THE CITY BULLETIN
BIDS WANTED - PURCHASING OFFICE AND OTHER DIVISIONS

RFQ025407 - Jet Aviation Fuel UTC

1.0 SCOPE AND CLASSIFICATION 1.1 Scope: This proposal is to provide the City of Columbus with a Universal Term Contract (blanket type) to purchase approximately one hundred five thousand (105,000) gallons annually of Jet Aviation Fuel for delivery to the Columbus Police Heliport location. The proposed contract will be in effect for a period of two (2) years from the date of execution by the City to and including October 31, 2025 with the option to extend for two (2) additional one (1) year periods. 1.2 Classification: The successful bidder will provide and deliver and unload bulk quantities of Jet Aviation Fuel. Bidders are required to show experience in providing this type of material as detailed in these specifications. 1.2.1 Bidder Experience: The offeror must submit an outline of its experience and work history in these types of materials for the past five years. 1.2.2 Bidder References: The offeror shall have documented proven successful contracts from at least four customers that the offeror supports that are similar in scope, complexity, and cost to the requirements of this specification. 1.3 For additional information concerning this bid, including procedures on how to submit a proposal, you must go to the City of Columbus Vendor Services web site at <http://vendors.columbus.gov/sites/public> and view this bid number.

RFQ025414 - Maxon Valves UTC

1.1 Scope: This proposal is to provide the City of Columbus with a Universal Term Contract (UTC) to purchase Maxon Valves to be used to control natural gas and digester gas feeding plant boilers and incinerators. The proposed contract will be in effect through July 31, 2025. 1.2 Classification: The successful bidder will provide and deliver Maxon valves. Bidders are required to show experience in providing this type of material and/or services as detailed in these specifications. 1.2.1 Bidder Experience: The offeror must submit an outline of its experience and work history in these types of materials and/or warranty service for the past five years. 1.2.2 Bidder References: The offeror shall have documented proven successful contracts from at least four customers that the offeror supports that are similar in scope, complexity, and cost to the requirements of this specification. 1.3 Specification Questions: Questions regarding this bid must be submitted on the Vendor Services portal by 4:00 pm Thursday, July 27, 2023. Responses will be posted on the RFQ on Vendor Services no later than Thursday August 3, 2023 at 4:00 pm. 1.4 For additional information concerning this bid, including procedures on how to submit a proposal, you must go to the City of Columbus Vendor Services web site at <http://vendors.columbus.gov/sites/public> and view this bid number.

RFQ025421 - Dept of Finance - Fleet Management - Riding Floor Scrubbers

Scope: It is the intent of the City of Columbus, Fleet Management Division/Department of Finance to obtain formal bids to establish a contract for the purchase of two (2) new, unused and complete battery powered rider floor scrubbers. 1.2 Classification: The contract resulting from this bid proposal will provide for the purchase and delivery of two (2) battery powered rider floor scrubbers, One (1) with a cleaning path of 29 inches and one (1) with a cleaning path of 36 inches. All Offerors must document the manufacture certified reseller partnership. Bidders are required to show experience in providing this type of equipment and warranty service as detailed in these specifications. 1.2.1 Bidder Experience: The offeror must submit an outline of its experience and work history in these types of equipment and warranty service for the past five years. 1.2.2 Bidder References: The offeror shall have documented proven successful contracts from at least four customers that the offeror supports that are similar in scope, complexity, and cost to the requirements of this specification. 1.3 Specification Questions: Questions regarding this bid must be submitted on the Vendor Services portal by 4:00 p.m. Thursday, July 27, 2023. Responses will be posted on the RFQ on Vendor Services no later than Thursday August 3, 2023 at 4:00 p.m. 1.4 For additional information concerning this bid, including procedures on how to submit a proposal, you must go to the City of Columbus Vendor Services web site at <http://vendors.columbus.gov/sites/public> and view this bid number.

THE CITY BULLETIN
BIDS WANTED - PURCHASING OFFICE AND OTHER DIVISIONS

RFQ025448 - DPS - 5913 - (3) F250 Lighting and Snow Upfits

1.0 SCOPE AND CLASSIFICATION 1.1 Scope: It is the intent of the City of Columbus, Department of Public Service/Division of Traffic Management to obtain formal bids to establish a contract for the installation of three (3) each of the following: new arrow boards, new light bars, new snow plows, and new sets of front and rear strobes onto three (3) City supplied pickup trucks. The installation cost will include all related components (wiring/control module/cab command controls/etc.). The trucks will need to be picked up from and delivered to the City of Columbus Fleet Management facility. Upon delivery back to the City, trucks shall have fully operational power operated: arrow boards, light bars, snow plows, and strobes. 1.2 Classification: The contract resulting from this bid proposal will provide pick-up and delivery of the F250 Crew Cabs from the City of Columbus for the installation of three (3) each of the following: new arrow boards, new light bars, new snow plows, and new sets of front and rear strobes, onto three (3) City supplied pickup trucks. The installation cost will include all related components (wiring/control module/cab command controls/etc.). Bidders are required to show experience in providing these types of equipment and warranty service as detailed in these specifications. 1.2.1 Bidder Experience: Offeror must submit an outline of its experience and work history in these types of equipment and warranty service for the past five years. 1.2.2 Bidder References: Offeror shall have documented proven successful contracts from at least four customers that the offeror supports that are similar in scope, complexity, and cost to the requirements of this specification. 1.3 Specification Questions: Questions regarding this bid must be submitted on the Vendor Services portal by 11:00 am, July 31, 2023. Responses will be posted on the RFQ on Vendor Services no later than Thursday, August 3, 2023 at 11:00 am. 1.4 For additional information concerning this bid, including procedures on how to submit a proposal, you must go to the City of Columbus Vendor Services web site at <http://vendors.columbus.gov/sites/public> and view this bid number.

BID OPENING DATE - 8/15/2023 2:00:00 PM

RFQ025395 - Big Walnut & Whetstone Water Service Improvements

The City of Columbus (hereinafter "City") is accepting bids for BIG WALNUT & WHETSTONE WATER SERVICE IMPROVEMENTS (PIDS 1010 & 1029), the work for which consists of the abandonment of existing water services and installation of new water services, including direction boring, electric, and other such work as may be necessary to complete the contract, in accordance with the drawings, technical specifications, plans and City of Columbus Construction and Material specifications set forth in this Invitation For Bid (IFB). WHERE & WHEN TO SUBMIT BID Bids will be received by the City of Columbus, Department of Recreation & Parks, at www.bidexpress.com until Tuesday, 8/15/23 at 2:00 P.M. Eastern Time. DRAWINGS AND TECHNICAL SPECIFICATIONS Drawings and technical specifications are available as separate documents at www.bidexpress.com. Drawings and technical specifications are contract documents. NOTICE TO PROCEED/CONTRACT COMPLETION The City anticipates issuing a notice to proceed on or about October 2023. All work is to be complete NLT 270 days from NTP. QUESTIONS CONCERNING THE BID DOCUMENTS OR PROJECT Questions pertaining to the drawings, plans, specifications, IFB, and/or other contract documents must be submitted in writing to the Department of Recreation & Parks by email to John Carlisle at JCarlisle@columbus.gov through Wednesday, August 9, 2023. No phone calls will be accepted.

THE CITY BULLETIN
BIDS WANTED - PURCHASING OFFICE AND OTHER DIVISIONS

RFQ025409 - 1511 Alum Industrial Interior Renovations

The City of Columbus (hereinafter "City") is accepting bids for the 1511 Alum Industrial Interior Renovations (PID1038) project, the work for which consists of renovation of interior office spaces, and other such work as may be necessary to complete the contract, in accordance with the drawings, technical specifications, plans and City of Columbus Construction and Material specifications set forth in this Invitation For Bid (IFB). This project is located at 1511 Alum Industrial Drive West, Columbus, OH 43209. WHERE & WHEN TO SUBMIT BID Bids will be received by the City of Columbus, Department of Recreation & Parks, at www.bidexpress.com until August 15, 2023 at 2:00 P.M. Eastern Time. DRAWINGS AND TECHNICAL SPECIFICATIONS Drawings and technical specifications are available as separate documents at www.bidexpress.com. Drawings and technical specifications are contract documents. PRE-BID CONFERENCE A mandatory pre-bid conference will be held at on Wednesday August 2, 2023 at 1:00PM. Bidders must examine the interior condition of the project area to be qualified for submitting a construction bid. NOTICE TO PROCEED/CONTRACT COMPLETION The City anticipates issuing a notice to proceed on or about October/November 2023. All work is to be substantially complete within 8 months of notice to proceed. QUESTIONS CONCERNING THE BID DOCUMENTS OR PROJECT Questions pertaining to the drawings, plans, specifications, IFB, and/or other contract documents must be submitted in writing to the Department of Recreation & Parks by email to cmscannell@columbus.gov through August 9, 2023 at 5PM. No phone calls will be accepted.

RFQ025461 - Main Entry Signage Program 2023

The City of Columbus is accepting Bids for the Main Entry Signage Program 2023 for which consists of the fabrication and installation of main park entry signs (routed plastic) and sign posts, and other such work as may be necessary to complete the contract, in accordance with the scope of services set forth in this Invitation for Bid (IFB). WHERE & WHEN TO SUBMIT BID Bids will be received by the City of Columbus, Department of Recreation & Parks, Design & Construction, until August 15th, 2023 at 2:00 pm local time. The bid should be emailed to Jamie Schlichting at jpschlichting@columbus.gov with the subject stating, "Main Entry Signage Program 2023 – Company Name". SCHEDULE The City anticipates issuing a Notice to Proceed by November 2023. The Contractor must complete all installations and any punch list items by August 1st, 2024. Questions regarding the IFB should be submitted to Jamie Schlichting, City of Columbus, Planning & Design, via email jpschlichting@columbus.gov prior to August 8th, 2023 at 5:00 pm local time.

RFQ025464 - Linview Park Improvements 2023 - REBID

The City of Columbus (hereinafter "City") is accepting bids for Linview Park Improvements 2023, the work for which consists of the installation of playground equipment, site furnishings, shelter house, solar lighting, concrete paths, landscaping, and other such work as may be necessary to complete the contract, in accordance with the drawings, technical specifications, plans and City of Columbus Construction and Material specifications set forth in this Invitation For Bid (IFB). WHERE & WHEN TO SUBMIT BID Bids will be received by the City of Columbus, Department of Recreation & Parks, at www.bidexpress.com until August 15th, 2023 at 2:00 P.M. Eastern Time. DRAWINGS AND TECHNICAL SPECIFICATIONS Drawings and technical specifications are available as separate documents at www.bidexpress.com. Drawings and technical specifications are contract documents. NOTICE TO PROCEED/CONTRACT COMPLETION The City anticipates issuing a notice to proceed on or about November 2023. All work is to be complete by November, 2024. QUESTIONS CONCERNING THE BID DOCUMENTS OR PROJECT Questions pertaining to the drawings, plans, specifications, IFB, and/or other contract documents must be submitted in writing to the Department of Recreation & Parks by email to Jamie Schlichting at jpschlichting@columbus.gov from 7/25/2023 until 8/8/2023. No phone calls will be accepted.

THE CITY BULLETIN
BIDS WANTED - PURCHASING OFFICE AND OTHER DIVISIONS

RFQ025508 - Land Survey - Linden Green Line Property

The Department is seeking an ALTA/NSPS boundary survey of an approximate 7 mile abandoned rail corridor in the City's Linden and Northland communities. Attached to this Request for Proposal are mapping documents and deed furnished to Recreation and Parks by the owner. Deadline to submit RFP to CRPD no later than: Monday August 15 @ 2:00 p.m. EST. Proposal should be submitted digitally in pdf format to: Columbus Recreation and Parks Brad Westall, Planning Manager (614) 645-2441 brwestall@columbus.gov

RFQ025509 - Raymond & Wilson GC Bridge Imp 2023

The City of Columbus (hereinafter "City") is accepting bids for Raymond & Wilson Golf Course Bridge Improvements 2023, the work for which consists of decking repair and replacement, abutment repair, wingwall installations, rock channel protection installation, cart path and bridge approach repair, and other such work as may be necessary to complete the contract, in accordance with the drawings, technical specifications, plans and City of Columbus Construction and Material specifications set forth in this Invitation For Bid (IFB). WHERE & WHEN TO SUBMIT BID Bids will be received by the City of Columbus, Department of Recreation & Parks, at www.bidexpress.com until 8/15/2023 at 2:00 P.M. Eastern Time. DRAWINGS AND TECHNICAL SPECIFICATIONS Drawings and technical specifications are available as separate documents at www.bidexpress.com. Drawings and technical specifications are contract documents. PRE-BID CONFERENCE A pre-bid conference WILL be held on August 3rd, 2023 from 10:00am to 11:00am. Attendance is NOT mandatory, but strongly encouraged for potential respondents to ask questions and better understand the project. Use the information below to join this virtual pre-bid conference. NOTICE TO PROCEED/CONTRACT COMPLETION The City anticipates issuing a notice to proceed on or about October 2023. All work is to be complete by April 1st, 2024. QUESTIONS CONCERNING THE BID DOCUMENTS OR PROJECT Questions pertaining to the drawings, plans, specifications, IFB, and/or other contract documents must be submitted in writing to the Department of Recreation & Parks by email to Jamie Schlichting at jpschlichting@columbus.gov through 8/8/2023. No phone calls will be accepted.

BID OPENING DATE - 8/16/2023 3:00:00 PM

RFQ025427 - DPU ARCHIVE / RECORDS STORAGE AND SMOC LOCKER ROOM RENO

DPU ARCHIVE / RECORDS STORAGE AND SMOC LOCKER ROOM RENOVATIONS BIDS ACCEPTED ONLY AT WWW.BIDEXPRESS.COM City of Columbus MBE/WBE GOAL FOR THIS CONTRACT: 15%

THE CITY BULLETIN
BIDS WANTED - PURCHASING OFFICE AND OTHER DIVISIONS

BID OPENING DATE - 8/17/2023 10:00:00 AM

RFQ025451 - Roadway – Material Testing and Inspection 2023

1.1 Scope: The City of Columbus, Department of Public Service is receiving proposals until August 17, 2023 at 10:00 A.M. local time, for professional services for the Roadway – Material Testing and Inspection 2023 RFP. Proposals are being received electronically by the Department of Public Service, Office of Support Services via Bonfire at <https://columbus.bonfirehub.com/login>. This project involves construction inspection services and materials testing for City of Columbus projects and may also be used for other projects for which the City is providing construction inspection services and materials testing, and other such work as may be necessary to complete the contract, as set forth in this Request for Proposals (RFP). All questions concerning the RFP are to be sent to capitalprojects@columbus.gov. The last day to submit questions will be specified in the RFP; phone calls will not be accepted. Responses will be posted on Bonfire at <https://columbus.bonfirehub.com/login> as an addendum. A pre-proposal meeting will not be held. Notice of published addenda will be posted on the City's Vendor Services web site and all addenda will be posted on Bonfire at <https://columbus.bonfirehub.com/login>. The selected Consultant shall attend a scope meeting anticipated to be held on/about two weeks after proposals are due. The projected scope date will be specified in the RFP. If the Project Manager is not available, the Consultant may designate an alternate to attend in their place. 1.2 Classification: All proposal documents (Request for Proposal, reference documents, addenda, etc.) will be available for review and download on Bonfire at <https://columbus.bonfirehub.com/login> after the RFP is advertised. Firms must meet the mandatory requirements stated in the RFP for a proposal to be considered for contract award. 1.3 Bonfire: If you do not have an account with Bonfire and you would like to review project information or submit a proposal, you will need to register for an account. Go to <https://columbus.bonfirehub.com/login> in order to sign up. 1.4 City of Columbus MBE/WBE Program: This project is subject to the requirements of the City's MBE/WBE Program. The MBE/WBE goal assigned to this project is 20.0%.

BID OPENING DATE - 8/17/2023 11:00:00 AM

RFQ025488 - HD Specialty Services UTC

1.0 SCOPE AND CLASSIFICATION 1.1 Scope: This proposal is to provide the City of Columbus with a Universal Term Contract to purchase HD Specialty Services of commercial trucks and specialty inspection and certification of equipment as well as a "catalog" firm offer for sale of various parts needed for service of the equipment. The City may purchase any item(s) or group of like items from the successful bidder after a purchase order for the listed items is issued. The proposed contract(s) will be in effect through September 30, 2025. 1.2 Classification: The successful bidder will provide for the option of purchasing repairs, services and parts for various City heavy duty vehicles per the bid document. Bidders are asked to quote discounts off price list/catalog pricing. Bidders are required to show experience in providing this type of material and/or services as detailed in these specifications. 1.2.1 Bidder Experience: The offeror must submit an outline of its experience and work history in these types of materials and/or warranty service for the past five years. 1.2.2 Bidder References: The offeror shall have documented proven successful contracts from at least four customers that the offeror supports that are similar in scope, complexity, and cost to the requirements of this specification. 1.3 For additional information concerning this bid, including procedures on how to submit a proposal, you must go to the City of Columbus Vendor Services web site at <http://vendors.columbus.gov/sites/public> and view this bid number.

THE CITY BULLETIN
BIDS WANTED - PURCHASING OFFICE AND OTHER DIVISIONS

RFQ025506 - DOSD-Surveillance Lab AGILENT

1.1 Scope: It is the intent of the City of Columbus, Division of Sewers and Drains/Department of Public Utilities to obtain formal bids to establish a contract for the purchase of Triple Quadrupole LC/MS/MS to be used by the Surveillance Laboratory for the testing pFAS and Azoles in wastewater. 1.2 Classification: The contract resulting from this bid proposal will provide for the purchase and delivery of an Agilent 6495 quadrupole LC/MS. All offerors must document the manufacture certified reseller partnership. Bidders are required to show experience in providing this type of equipment and warranty service as detailed in these specifications. 1.2.1 Bidder Experience: The offeror must submit an outline of its experience and work history in these types of equipment and warranty service for the past five years. 1.2.2 Bidder References: The offeror shall have documented proven successful contracts from at least four customers that the offeror supports that are similar in scope, complexity, and cost to the requirements of this specification

1.3 Specification Questions: Questions regarding this bid must be submitted on the Vendor Services portal by 11:00 am Thursday, August 3rd, 2023. Responses will be posted on the RFQ on Vendor Services no later than Tuesday, August 8th, 2023 at 11:00 am. 1.4 For additional information concerning this bid, including procedures on how to submit a proposal, you must go to the City of Columbus Vendor Services web site at <http://vendors.columbus.gov/sites/public> and view this bid number.

RFQ025507 - DOSD-Surveillance Lab EXTRACTORS

1.0 SCOPE AND CLASSIFICATION 1.1 Scope: It is the intent of the City of Columbus, Division/Department of Public Utilities to obtain formal bids to establish a contract for the purchase of two (2) Solid Phase Extractors to prepare samples for pFAS and Azoles in wastewater. 1.2 Classification: The contract resulting from this bid proposal will provide for the purchase and delivery of two (2) Solid Phase Extractors. All offerors must document the manufacture certified reseller partnership. Bidders are required to show experience in providing this type of equipment and warranty service as detailed in these specifications. 1.2.1 Bidder Experience: The offeror must submit an outline of its experience and work history in these types of equipment and warranty service for the past five years. 1.2.2 Bidder References: The offeror shall have documented proven successful contracts from at least four customers that the offeror supports that are similar in scope, complexity, and cost to the requirements of this specification. 1.3 Specification Questions: Questions regarding this bid must be submitted on the Vendor Services portal by 11:00 am, Thursday August 3rd, 2023. Responses will be posted on the RFQ on Vendor Services no later than Tuesday, August 8th, 2023 at 11:00 am. 1.4 For additional information concerning this bid, including procedures on how to submit a proposal, you must go to the City of Columbus Vendor Services web site at <http://vendors.columbus.gov/sites/public> and view this bid number.

RFQ025513 - R.P. Adams Automatic Backwasher Strainer

1.0 SCOPE AND CLASSIFICATION 1.1 Scope: It is the intent of the City of Columbus, Department of Public Utilities to obtain formal bids to establish a contract for the purchase of a 4" Automatic Backwash Strainer to be used at the Jackson Pike Wastewater Treatment Plant to filter flushing water. This will allow the plant to use more flushing water in the process equipment, which will reduce the usage of potable water. 1.2 Classification: The contract resulting from this bid proposal will provide for the purchase and delivery of a 4" Automatic Backwash Strainer. 1.3 Specification Questions: Questions regarding this bid must be submitted on the Vendor Services portal by 11:00 am Thursday, August 3rd 2023. Responses will be posted on the RFQ on Vendor Services no later than Tuesday, August 8th at 11:00 am 2023. 1.4 For additional information concerning this bid, including procedures on how to submit a proposal, you must go to the City of Columbus Vendor Services web site at <http://vendors.columbus.gov/sites/public> and view this bid number.

THE CITY BULLETIN
BIDS WANTED - PURCHASING OFFICE AND OTHER DIVISIONS

BID OPENING DATE - 8/17/2023 1:00:00 PM

RFQ025450 - Resurfacing - 2023 Slurry Seal-Crack Seal

1.1 Scope: The City of Columbus, Department of Public Service is receiving bids until August 17, 2023 at 1:00 PM local time, for construction services for the Resurfacing - 2023 Slurry Seal-Crack Seal project. Bids are to be submitted only at www.bidexpress.com. Hard copies shall not be accepted. This project crack seals 125 city streets and slurry seals 153 streets. The work consists of applying crack seal and slurry seal along those streets, and other such work as may be necessary to complete the contract, as set forth in this Invitation For Bid (IFB). All questions concerning this project are to be sent to capitalprojects@columbus.gov. The last day to submit questions will be specified in the IFB; phone calls will not be accepted. Responses will be posted on Bid Express at www.bidexpress.com as an addendum. A pre-bid meeting will not be held. Notice of published addenda will be posted on the City's Vendor Services web site and all addenda will be posted on www.bidexpress.com. 1.2 Classification: All bid documents (Invitation for Bid, technical specifications, plans, and future addenda) will be available for review and download on Bid Express at www.bidexpress.com after the IFB is published. Firms must meet the mandatory requirements stated in the IFB for a bid to be considered for contract award. 1.3 Bid Express: If you do not have an account with Bid Express and you would like to review project information or submit a bid, you will need to register for an account. Go to www.bidexpress.com in order to sign up. 1.4 City of Columbus MBE/WBE Program: This project is subject to the requirements of the City's MBE/WBE Program. The MBE/WBE goal assigned to this project is 10.0%. The contract will be awarded to the lowest, responsive, responsible, and best bidder. City certified MBE/WBE firms that submit a proposal may be eligible to receive a bid discount of 5% of the bid amount up to a maximum discount of \$50,000.00. To be eligible for the bid discount, the firm must: • Be the prime contractor. • Be certified by the City's Office of Diversity and Inclusion as an MBE/WBE capable of providing the type of construction services sought by the City at the bid due date. • Be a member of the ethnic and gender groups determined by the City's 2019 Disparity Study to have a statistically significant disparity in the awarding of City construction contracts. (The eligible groups for Construction IFB's are all City certified MBE/WBE firms except Hispanic American Male firms.) • Submit a completed Bid Discount / Proposal Incentive Request Form with the proposal. Contact the Office of Diversity and Inclusion, Tia Roseboro, Contract Compliance and Certification Programs Manager, at THRoseboro@Columbus.gov with any questions concerning companies eligible to participate in the program.

BID OPENING DATE - 8/17/2023 2:00:00 PM

RFQ025571 - Turnberry Golf Course Carpet Replacement

The City of Columbus is accepting Bids for the Turnberry Golf Course Carpet Replacement for which consists of the removal of existing carpet, installation of carpet, disposal of all materials and other such work as may be necessary to complete the contract, in accordance with the scope of services set forth in this Invitation for Bid (IFB). Bids will be received by the City of Columbus, Department of Recreation & Parks, Design & Construction, until August 17, 2023 at 2:00 pm local time. The bid should be emailed to Mike Musser, MRMusser@columbus.gov with the subject stating, "Turnberry GC Carpet Replacement – Company Name". The Contractor must perform all work between November 1, 2023 and December 23, 2023. Weekend work is permitted. All work must be substantially complete by December 1, 2023. These are strict timelines that cannot be adjusted due to facility programming and access. Questions regarding the IFB should be submitted to Mike Musser, City of Columbus, Golf Courses Administrator, MRMusser@Columbus.gov prior to August 10, 2023 at 2:00 pm local time.

THE CITY BULLETIN
BIDS WANTED - PURCHASING OFFICE AND OTHER DIVISIONS

BID OPENING DATE - 8/18/2023 12:00:00 PM

RFQ025394 - Emergency Dispatch Call Processing Solution

The CITY of Columbus, Department of Public Safety (DPS) is soliciting proposals from qualified firms for the procurement and implementation of a turnkey solution for a comprehensive 911 Call Processing Solution to be used for police, fire, and EMS calls received within the 911 Emergency Communications Center. The contract resulting from this bid proposal will provide for the purchase and delivery of a complete turnkey emergency dispatch call processing solution that includes the core components of a protocol system. This system must contain a computerized version of protocols that will be the primary means of entry; backup cards sets; quality assurance/quality improvement (QA/QI) component and associated training/certification (to include remote/third-party QA through evaluation reporting, analysis, training, and QI recommendations); certification of communication employees; training (to include trainer certification for future classes [any trainer requirements shall be noted]); implementation; and other components necessary for a turnkey product. The proposal shall provide costs for all components as well as costs for accreditation and annual maintenance costs. All Offeror's must document the manufacture certified reseller partnership. Bidders are required to show experience in providing this type of equipment and warranty service as detailed in these specifications. See attached for further information.

BID OPENING DATE - 8/24/2023 11:00:00 AM

RFQ025424 - Goulds Xylem Pump Parts & Accessories UTC

1.1 Scope: It is the intent of the City of Columbus, Division of Water to solicit bids to provide a Universal Term Contract (option type contract) to supply parts and/or services to repair/rebuild existing Goulds/Xylem submersible pumps. The contract will be in effect from the date of execution by the City to and including September 30, 2025

1.2 Classification: The contract resulting from this proposal will provide for the purchase and delivery of replacement parts for the Goulds/Xylem submersible pumps listed herein. The contract will also provide for services to repair/rebuild existing Goulds/Xylem submersible pumps. The repair/rebuild portion may include removal and installation of pumps at City-owned facilities, in addition to providing various machine shop services for repairing parts and assemblies to meet original manufacturer's specifications. The award will be made to a provider that will provide both parts and services. The city intends to award to the bidder providing the greatest breadth and depth of goods and services. Bidders are requested to show experience in providing the equipment and repair service as detailed in these specifications, per section 3.1.4.

1.2.1 Bidder Experience: The Goulds/Xylem Pump equipment offeror must submit an outline of their experience and work history providing this type of equipment and warranty service for the past five years.

1.2.2 Bidder References: The offeror shall have documented proven successful contracts from at least four customers that the offeror supports that are similar in scope, complexity, and cost to the requirements of this specification.

1.3 Specification Questions: Questions regarding this bid must be submitted on the Vendor Services portal by 4:00 p.m. Thursday August 10, 2023. Responses will be posted on the RFQ on Vendor Services no later than Thursday, August 17, 2023 at 4:00 am.

1.4. For additional information concerning this bid, including procedures on how to submit a proposal, you must go to the City of Columbus Vendor Services web site <http://vendors.columbus.gov/sites/public> and view this bid number.

THE CITY BULLETIN
BIDS WANTED - PURCHASING OFFICE AND OTHER DIVISIONS

RFQ025462 - DOW Crew Trucks

1.0 SCOPE AND CLASSIFICATION 1.1 Scope: It is the intent of the City of Columbus, Department of Public Utilities/Division of Water to obtain formal bids to establish a contract for the purchase of Two (2) Water Maintenance Crew Cab Trucks to purchase crew cab trucks with maintenance bodies to be used for repair and maintenance of underground water lines. 1.2 Classification: The contract resulting from this bid proposal will provide for the purchase and delivery of Two (2) Water Maintenance Crew Cab trucks. All Offerors must document the manufacture certified reseller partnership. Bidders are required to show experience in providing this type of equipment and warranty service as detailed in these specifications. 1.2.1 Bidder Experience: The offeror must submit an outline of its experience and work history in these types of equipment and warranty service for the past five years. 1.2.2 Bidder References: The offeror shall have documented proven successful contracts from at least four customers that the offeror supports that are similar in scope, complexity, and cost to the requirements of this specification. 1.3 Specification Questions: Questions regarding this bid must be submitted on the Vendor Services portal by 11:00 am Monday, August 7, 2023. Responses will be posted on the RFQ on Vendor Services no later than Thursday, August 10, 2023 at 11:00 am. 1.4 For additional information concerning this bid, including procedures on how to submit a proposal, you must go to the City of Columbus Vendor Services web site at <http://vendors.columbus.gov/sites/public> and view this bid number.

RFQ025475 - Dept of Finance - Fleet Management - CDL Truck

1.0 SCOPE AND CLASSIFICATION 1.1 Scope: It is the intent of the City of Columbus, Department of Finance/Division of Fleet Management, to obtain formal bids to establish a contract for one (1) 35,000lb GVW CDL truck with a 5th wheel hitch. 1.2 Classification: The contract resulting from this bid proposal will provide for the purchase and delivery of one CDL truck. All Offerors must document the manufacture certified reseller partnership. Bidders are required to show experience in providing this type of equipment and warranty service as detailed in these specifications. 1.2.1 Bidder Experience: The offeror must submit an outline of its experience and work history in these types of equipment and warranty service for the past five years. 1.2.2 Bidder References: The offeror shall have documented proven successful contracts from at least four customers that the offeror supports that are similar in scope, complexity, and cost to the requirements of this specification. 1.3 Specification Questions: Questions regarding this bid must be submitted on the Vendor Services portal by 11:00 am Monday, August 7, 2023. Responses will be posted on the RFQ on Vendor Services no later than Thursday, August 10, 2023 at 11:00 am. 1.4 For additional information concerning this bid, including procedures on how to submit a proposal, you must go to the City of Columbus Vendor Services web site at <http://vendors.columbus.gov/sites/public> and view this bid number.

RFQ025487 - Fleet Management - CDL Flatbed Trailer

1.0 SCOPE AND CLASSIFICATION 1.1 Scope: It is the intent of the City of Columbus, Fleet Management to obtain formal bids to establish a contract for the 1 (one) 40ft single axle flatbed semi trailer. 1.2 Classification: The contract resulting from this bid proposal will provide for the purchase and delivery of 1 (one) 40ft single axle flatbed trailer. All Offerors must document the manufacture certified reseller partnership. Bidders are required to show experience in providing this type of equipment and warranty service as detailed in these specifications. 1.2.1 Bidder Experience: The offeror must submit an outline of its experience and work history in these types of equipment and warranty service for the past five years. 1.2.2 Bidder References: The offeror shall have documented proven successful contracts from at least four customers that the offeror supports that are similar in scope, complexity, and cost to the requirements of this specification. 1.3 Specification Questions: Questions regarding this bid must be submitted on the Vendor Services portal by 11:00 am Monday, August 7, 2023. Responses will be posted on the RFQ on Vendor Services no later than Thursday, August 10, 2023 at 11:00 am. 1.4 For additional information concerning this bid, including procedures on how to submit a proposal, you must go to the City of Columbus Vendor Services web site at <http://vendors.columbus.gov/sites/public> and view this bid number.

THE CITY BULLETIN
BIDS WANTED - PURCHASING OFFICE AND OTHER DIVISIONS

RFQ025549 - Emotron Parts and Services UTC

1.1 Scope: It is the intent of the City of Columbus, Division of Sewerage and Drainage to solicit formal bids for a Universal Term Contract for the purchase of Emotron Parts and Services for use by the Jackson Pike Wastewater Treatment Plant. The equipment is used in the aeration process at the plant. The contract will be in effect to and including July 31, 2025. 1.2 Classification: This bid proposal and the resulting contract will provide for the purchase of Emotron Parts and Services. Items listed are considered items that will be ordered more often from this contract. Bidders are being asked to quote on the items listed, hourly and over-time service rates and to submit a price list for items not specifically listed. No substitutes will be accepted. Direct replacement only. Bidders are required to show experience in providing this type of equipment as detailed in these specifications. 1.2.1 Bidder Experience: The offeror must submit an outline of its experience and work history in these types of materials and/or warranty service for the past five years. 1.2.2 Bidder References: The offeror shall have documented proven successful contracts from at least four customers that the offeror supports that are similar in scope, complexity, and cost to the requirements of this specification. 1.3 Specification Questions: Questions regarding this bid must be submitted on the Vendor Services portal by 4:00 pm Thursday August 10, 2023. Responses will be posted on the RFQ on Vendor Services no later than Thursday August 17, 2023 at 4:00 pm. 1.4 For additional information concerning this bid, including procedures on how to submit a proposal, you must go to the City of Columbus Vendor Services web site at <http://vendors.columbus.gov/sites/public> and view this bid number.

BID OPENING DATE - 8/30/2023 1:00:00 PM

RFQ025534 - Diesel, CNG & Non-CDL Dump/Live Body Trucks & Snow Equipment

1.0 SCOPE AND CLASSIFICATION 1.1 Scope: The City of Columbus is seeking Request for Proposals in response to a Best Value Procurement (BVP) to enter into a Universal Term Contract (indefinite quantity) to purchase various types of Dump Trucks and Live Body Trucks to be used by multiple City agencies. The City will negotiate a contract with the selected vendor(s) for a term of three (3) years beginning the date of execution through December 31, 2026 with one additional one-year extension option. For additional information concerning this BVP, including procedures on how to submit a proposal, you must go to the City of Columbus Vendor Services web site at <http://vendors.columbus.gov/sites/public> and view this bid number detailed instructions. Bid proposal specifications are available through the following link: <https://columbus.bonfirehub.com/opportunities/102073>.

THE CITY BULLETIN
BIDS WANTED - PURCHASING OFFICE AND OTHER DIVISIONS

BID OPENING DATE - 8/31/2023 11:00:00 AM

RFQ025540 - Fire Dress & Work Uniforms UTC

1.0 SCOPE AND CLASSIFICATION 1.1 Scope: This proposal provides the City of Columbus, Division of Fire, with a Universal Term Contract to purchase dress and work uniforms for its sworn personnel. It is estimated that one million dollars (\$1,000,000.00) will be spent annually on this contract. The proposed contract will be in effect for three (3) years from the date of execution by the City through November 30, 2026. 1.1.1 The City of Columbus reserves the right to allow awarded vendors up to six (6) months from the date of execution of the contract to establish a business location to meet requirements for specifications listed in sections 3.3 through 3.3.4.2. 1.2 Classification: The successful bidder will provide and deliver dress and work uniforms for the Division of Fire, which includes hats, caps, trousers, shirts, jackets, t-shirts, sweat clothes, buttons, insignias, shoes, boots, gloves, and related items for its Division members, as well as the Division Honor Guard, the Pipe Band, and special teams. The contract will also provide measurement, purchase, and distribution of these items. All purchases from this contract will be on an as-need basis. Bidders must show experience in providing this type of material and services as detailed in these specifications. 1.2.1 Bidder Experience: The offeror must submit an outline of their experience and work history in these materials and warranty services for the past five years. 1.2.2 Bidder References: The offeror shall have documented proven successful contracts from at least four customers that the offeror supports that are similar in scope, complexity, and cost to the requirements of this specification. 1.3 Specification Questions: Questions regarding this bid must be submitted on the Vendor Services portal by 11:00 AM Tuesday August 15, 2023. Responses will be posted on the RFQ on Vendor Services no later than Friday, August 18, 2023 at 11:00 AM. 1.4 Pre-Bid Site Visit: A walk-through of the warehouse facility where the Division of Fire, Quarter Master Office, 4252 Groves Road, is located. The walk-through is scheduled for Friday, August 11, 2023 @ 9:00 AM. Attendance is not required; however, this will be the only opportunity for bidders to view the warehouse facility. See Section 3.2.5 for further information. 1.5 For additional information concerning this bid, including proposal submission procedures, go to the City of Columbus Vendor Services website and view this bid number.

BID OPENING DATE - 8/31/2023 2:00:00 PM

RFQ025528 - CITY HALL ELECTRICAL UPGRADE REBID

1.1 Scope: The City of Columbus, Department of Finance and Management is receiving bids until 2:00 P.M. local time, August 31, 2023, for construction services for the CITY HALL ELECTRICAL UPGRADE REBID project. Bids are to be submitted only at www.bidexpress.com. Hard copies shall not be accepted. The project includes upgrading the AEP service to 480 Volts for the City Hall Building at 90 W Broad Street, Columbus, Ohio. City Hall currently has municipal power as its primary power service. The scope of this project includes a new transfer switch, backup power for security operations, and all associated work as may be necessary to complete the contract, in accordance with the drawings, technical specifications, and City of Columbus Construction and Material Specifications as set forth in this Invitation For Bid (IFB) 1.2 Classification: All bid documents (Invitation for Bid, technical specifications, plans, and future addenda) are available for review and download at www.bidexpress.com. Firms wishing to submit a bid must meet the mandatory requirements stated in the IFB, including being pre-qualified by the City of Columbus Office of Construction Prequalification. A pre-bid meeting will be held at 90 W Broad Street, Front Street Lobby, at 1:30 P.M. on August 7, 2023. Attendance is strongly encouraged. See the IFB for instructions as to how to submit questions. The last day to submit questions is August 23, 2023 at 12:00 P.M.. Notice of published addenda will be posted on the Bid Express website at www.bidexpress.com. Phone calls will not be accepted. 1.3 Bid Express: If you do not have an account with Bid Express and you would like to review projects information or submit a bid, you will need to sign up for an account. Go to www.bidexpress.com in order to sign up.

THE CITY BULLETIN
BIDS WANTED - PURCHASING OFFICE AND OTHER DIVISIONS

BID OPENING DATE - 9/22/2023 1:00:00 PM

RFQ025308 - Accelerate Columbus

BID OPENING DATE - 7/11/2024 1:00:00 PM

RFQ025020 - DOT/IVR/RFP

COMPLETE RFP AVAILABLE AT <https://columbus.bonfirehub.com/opportunities/96494>

Public Notices

The link to the Columbus City Health Code pdf shall constitute publication in the City Bulletin of changes to the Columbus City Health Department's Health Code. To go to the Columbus City Health Code, [click here \(pdf\)](#).

The Columbus City Code's "Title 7 -- Health Code" is separate from the Columbus City Health Code. Changes to "Title 7 -- Health Code" are published in the City Bulletin. To go to the Columbus City Code's "Title 7 -- Health Code," [click here \(html\)](#).

City of Columbus
City Bulletin Report

Office of City Clerk
90 West Broad Street
Columbus OH 43215-9015
columbuscitycouncil.org

Legislation Number: PN0026-2023

Drafting Date: 1/18/2023

Version: 1

Current Status: Clerk's Office for Bulletin

Matter Type: Public Notice

Notice/Advertisement Title: Columbus Zoning Code Update Advisory Committee 2023 Schedule

Contact Name: Kevin Wheeler

Contact Telephone Number: 614-645-6057

Contact Email Address: kjwheeler@columbus.gov

The Columbus Zoning Code Update (Zone-In) Advisory Committee is scheduled to meet at 4:00 PM on the following dates in the Community Room of the 141 North Front Street City parking garage.

*Meetings are subject to change or cancellation. Please contact staff to confirm or for more information.

January 4, 2023

February 1, 2023

March 1, 2023

April 5, 2023

May 3, 2023

June 7, 2023

July - NO MEETING SCHEDULED

August 2, 2023

September 6, 2023

October 4, 2023

November 1, 2023

December 6, 2023

Meeting Accommodations: It is the policy of the City of Columbus that all City-sponsored public meetings and events are accessible to people with disabilities. If you need assistance in participating in this meeting or event due to a disability as defined under the ADA, please call the City's ADA Coordinator at (614) 645-8871 or e-mail zdjones@columbus.gov at least three (3) business days prior to the scheduled meeting or event to request an accommodation.

Legislation Number: PN0053-2023

Drafting Date: 2/8/2023

Version: 1

Current Status: Clerk's Office for Bulletin

Matter Type: Public Notice

Notice/Advertisement Title: Columbus Recreation and Parks 2023 Updated Commission Meetings

Contact Name: Aniko Williams

Contact Telephone Number: 614-645-5932

Contact Email Address: arwilliams@columbus.gov

Columbus Recreation and Parks
2023 Updated Commission Meetings

NOTICE OF REGULAR MEETINGS

COLUMBUS RECREATION AND PARKS COMMISSION

The Recreation and Parks Commission, appointed and organized under the Charter of the City of Columbus, Section 112-1 is empowered to equip, operate, direct and maintain all the existing recreational and park facilities. In addition, said Commission exercises certain powers and duties as specified in Sections 112-1 and 112-2 of the Columbus City Charter.

Please take notice that meetings of the Recreation and Parks Commission will be held at 8:30a.m. on the following dates and locations (unless otherwise posted):

Tuesday, March 14, 2023 - 1111 East Broad Street, 43205
Tuesday, April 11, 2023- 1111 East Broad Street, 43205
Tuesday, May 9, 2023 - 1111 East Broad Street, 43205
Tuesday, June 13, 2023 - 1111 East Broad Street, 43205
Tuesday, July 11, 2023 - 1111 East Broad Street, 43205
August Recess - No Meeting
Tuesday, September 12, 2023 - 1111 East Broad Street, 43205
Tuesday, October 11, 2023 - 1111 East Broad Street, 43205
Tuesday, November 14, 2023 - 1111 East Broad Street, 43205
Tuesday, December 12, 2023 - 1111 East Broad Street, 43205

In the event no proper business exists, the meeting may be cancelled without further notice. For further information you may contact the Columbus Recreation and Parks Department, 1111 East Broad Street, Suite 200, Columbus, Ohio 43205 (Telephone: 614-645-3319).

Bernita A. Reese, Director
Columbus Recreation and Parks Department

Legislation Number: PN0209-2023

Drafting Date: 6/29/2023

Current Status: Clerk's Office for Bulletin

Version: 1

Matter Type: Public Notice

Notice/Advertisement Title: Columbus Art Commission 2023 Hearing and Application Schedule

Contact Name: Luis Teba

Contact Telephone Number: 614.645.8062

Contact Email Address: art@columbus.gov

Meeting Accommodations: It is the policy of the City of Columbus that all City-sponsored public meetings and events are accessible to people with disabilities. If you need assistance in participating in this meeting or event due to a disability as defined under the ADA, please call the City's ADA Coordinator at (614) 645- 8871 or e-mail zdjones@columbus.gov at least three (3) business days prior to the scheduled meeting or event to request an accommodation.

Application Deadline Hearing Dates**

(lfteba@columbus.gov)*

December 22, 2022 January 18, 2023

January 19, 2023 February 15, 2023
February 16, 2023 March 15, 2023
March 23, 2023 April 19, 2023
April 20, 2023 May 17, 2023
May 25, 2023 June 21, 2023
June 22, 2023 July 19, 2023
July 20, 2023 August 16, 2023
August 24, 2023 September 20, 2023
September 21, 2023 October 18, 2023
October 19, 2023 November 15, 2023
November 23, 2023 December 20, 2023
December 21, 2023 January 17, 2024

Hearings are held in-person in room 204 at the Coleman Government Center, 111 N. High Street, Columbus, OH 43215 and the start time will be **4:00 PM**. Staff should be contacted before an application and materials are submitted electronically. Hard copy submissions are no longer needed.

* If you have questions call 614.645.8062 (o).

**Meetings subject to cancellation and locations subject to change. Please contact staff to confirm. Meeting dates, times and locations are also available at www.columbus.gov/planning

Legislation Number: PN0222-2023

Drafting Date: 7/20/2023

Current Status: Clerk's Office for Bulletin

Version: 1

Matter Type: Public Notice

Notice/Advertisement Title: South Linden Area Commission to Hold Special Meeting August 11th

Contact Name: Lois Ferguson

Contact Telephone Number: 614-357-3315

Contact Email Address: slac.lferguson@yahoo.com

The South Linden Area Commission will hold a special meeting on Friday, August 11th, at 5:30 PM to discuss their 2023-2024 budget and memorandum of understanding. The meeting will be held at the Clarence Lumpkin Point of Pride building, 1410 Cleveland Ave, Columbus, OH 43211. For more information, please visit <https://cbusareacommissions.org/south-linden/>.

Legislation Number: PN0224-2023

Drafting Date: 7/21/2023

Current Status: Clerk's Office for Bulletin

Version: 1

Matter Type: Public Notice

Notice/Advertisement Title: 2023 Civilian Police Review Board Regular Meetings

Contact Name: Stephanie Brock

Contact Telephone Number: 614-645-9601

Contact Email Address: Civilianreviewboard@columbus.gov

**Civilian Police Review Board
2023 Board Meetings**

NOTICE OF REGULAR MEETINGS

CIVILIAN POLICE REVIEW BOARD

The Civilian Police Review Board, appointed and organized under the Charter of the City of Columbus, Section 235.02 is empowered promulgate rules and regulations, in accordance with C.C.C. Section 121.05 to carry out its duties as provided for in the Charter and in this chapter. In addition, said Commission exercises certain powers and duties as specified in Sections 235.03 of the Columbus City Charter.

Please take notice that meetings of the Civilian Police Review Board will be held at 2:00p.m. on the following dates and locations (unless otherwise posted):

Tuesday, August 1, 2023 - 111 North Front Street, 43215

Tuesday, September 5, 2023 - 111 North Front Street, 43215

Tuesday, October 3, 2023 - 111 North Front Street, 43215

Tuesday, November 7, 2023 - 111 North Front Street, 43215

Tuesday, December 5, 2023 - 111 North Front Street, 43215

In the event no proper business exists the meeting may be cancelled without further notice. For further information you may contact the Board's Executive Assistant, Stephanie Brock. Telephone: (614-645-9601), or at Email: Civilianreviewboard@columbus.gov

Brooke Burns, Chair
Civilian Police Review Board

Legislation Number: PN0228-2023

Drafting Date: 7/27/2023

Current Status: Clerk's Office for Bulletin

Version: 1

Matter Type: Public Notice

Notice/Advertisement Title: Development Commission Zoning Meeting Agenda - August 10, 2023

Contact Name: Tim Dietrich

Contact Telephone Number: (614) 645-6665

Contact Email Address: tedietrich@columbus.gov

The Development Commission of the City of Columbus will hold a public hearing on the following zoning applications on **THURSDAY, AUGUST 10, 2023**, beginning at **4:30 P.M.** at the **MICHAEL B. COLEMAN GOVERNMENT CENTER** at 111 North Front Street, Columbus, OH 43215 in the **2ND FLOOR HEARING ROOM**. You can also monitor the hearing through the City of Columbus YouTube channel at the following link: <http://www.youtube.com/cityofcolumbus>.

SIGN LANGUAGE INTERPRETER: A Sign Language Interpreter, to "Sign" this meeting, will be made available for anyone with a need for this service, provided the Department of Building & Zoning Services is made aware of this need and given a reasonable notice of at least forty-eight (48) hours prior to the scheduled meeting time. To schedule an

interpreter, please call 614-645-6373 or TDD 614-645-3293.

Further information may be obtained by visiting the City of Columbus Zoning Office website at <http://www.columbus.gov/bzs/zoning/Development-Commission> or by calling the Department of Building and Zoning Services, Council Activities Section at 614-645-4522.

THE FOLLOWING APPLICATIONS WILL BE HEARD ON THE 4:30 P.M. AGENDA:

1.APPLICATION: [Z22-012 <https://portal.columbus.gov/permits/urlrouting.ashx?type=1000&Module=Zoning&capID1=22LAC&capID2=00000&capID3=00160&agencyCode=COLUMBUS&HideHeader=true>](https://portal.columbus.gov/permits/urlrouting.ashx?type=1000&Module=Zoning&capID1=22LAC&capID2=00000&capID3=00160&agencyCode=COLUMBUS&HideHeader=true)

Location: 363 N. EUREKA AVE. (43204), being 2.26± acres located on the west side of North Eureka Avenue, approximately 180± north of Westwood Drive (425-300002 and 010-189674; Greater Hilltop Area Commission).

Existing Zoning: R, Rural District.

Request: M-2, Manufacturing District (H-35).

Proposed Use: Warehouse use.

Applicant(s): 370 N. Eureka LLC; c/o Christopher Orr; 1790 Victorian Court; Columbus, OH 43220; and Michael Shannon, Atty.; 8000 Walton Parkway, Suite 260; New Albany, OH 43054.

Property Owner(s): The Applicant.

Planner: Joseph Rose; 614-645-3526; jmrose@columbus.gov <mailto:jmrose@columbus.gov>

2.APPLICATION: [Z23-021 <https://portal.columbus.gov/permits/urlrouting.ashx?type=1000&Module=Zoning&capID1=23LAC&capID2=00000&capID3=00338&agencyCode=COLUMBUS&HideHeader=true>](https://portal.columbus.gov/permits/urlrouting.ashx?type=1000&Module=Zoning&capID1=23LAC&capID2=00000&capID3=00338&agencyCode=COLUMBUS&HideHeader=true)

Location: 5925 SAWMILL RD. (43017), being 0.86± acres located on the west side of Sawmill Road, 325± feet south of Krier Drive (590-193762; Northwest Civic Association).

Existing Zoning: CPD, Commercial Planned Development District.

Request: CPD, Commercial Planned Development District (H-35).

Proposed Use: Commercial development.

Applicant(s): CP Sawmill, LLC c/o Eric Leibowitz; 250 Civic Center Drive, Suite 500; Columbus, OH 43215.

Property Owner(s): The Applicant.

Planner: Tim Dietrich; 614-645-6665; tedietrich@columbus.gov <mailto:tedietrich@columbus.gov>

3.APPLICATION: [Z23-026 <https://portal.columbus.gov/permits/urlrouting.ashx?type=1000&Module=Zoning&capID1=23LAC&capID2=00000&capID3=00451&agencyCode=COLUMBUS&HideHeader=true>](https://portal.columbus.gov/permits/urlrouting.ashx?type=1000&Module=Zoning&capID1=23LAC&capID2=00000&capID3=00451&agencyCode=COLUMBUS&HideHeader=true)

Location: 3200 BRICE RD. (43110), being 1.77± acres located at the southeast corner of Brice Road and Refugee Road (530-257050; Greater Southeast Area Commission).

Existing Zoning: CPD, Commercial Planned Development District.

Request: CPD, Commercial Planned Development District (H-35).

Proposed Use: Child daycare center.

Applicant(s): Darin Ranker; 5925 Wilcox Place, Suite E; Dublin, OH 43017.

Owner(s): Ohio CVS Stores, LLC; One CVS Drive; Woonsocket, RI 02895.

Planner: Joseph Rose; 614-645-3526; jmrose@columbus.gov <mailto:jmrose@columbus.gov>

4.APPLICATION: [Z23-039 <https://portal.columbus.gov/permits/urlrouting.ashx?type=1000&Module=Zoning&capID1=23LAC&capID2=00000&capID3=00673&agencyCode=COLUMBUS&HideHeader=true>](https://portal.columbus.gov/permits/urlrouting.ashx?type=1000&Module=Zoning&capID1=23LAC&capID2=00000&capID3=00673&agencyCode=COLUMBUS&HideHeader=true)

Location: 5121-5125 WARNER RD. (43081), being 3.53± acres located on the south side of Warner Road, 150± feet west of North Hamilton Road (220-001188 and 220-000658; Rocky Fork Blacklick Accord Panel).

Existing Zoning: R, Rural District (upon annexation).

Request: AR-1, Apartment Residential District (H-35).

Proposed Use: Multi-unit residential development.

Applicant(s):Jared Smith, Preferred Living; c/o David Hodge, Atty.; Underhill and Hodge, LLC; 8000 Walton Parkway, Suite 260; New Albany, OH 43054.

Property Owner(s):Michelle Copley and Michelle Shirazadian; 5121 Warner Road; Westerville, OH 43081; and Jamie Helber; 5125 Warner Road; Westerville, OH 43081.

Planner:Jack Mangan; 614-645-3526; jrmangan@columbus.gov <<mailto:jmrose@columbus.gov>>

5.APPLICATION:[Z23-030 <https://portal.columbus.gov/permits/urlrouting.ashx?type=1000&Module=Zoning&capID1=23LAC&capID2=00000&capID3=00520&agencyCode=COLUMBUS&HideHeader=true>](https://portal.columbus.gov/permits/urlrouting.ashx?type=1000&Module=Zoning&capID1=23LAC&capID2=00000&capID3=00520&agencyCode=COLUMBUS&HideHeader=true)

Location:2677 WEYBURN RD. (43232), being 8.54± acres located at the northeast and northwest corners of Weyburn Road and Refugee Road (010-027888 and 010-027890; Mideast Area Commission).

Existing Zoning:C-2, Commercial District.

Request:ARLD, Apartment Residential District (H-60).

Proposed Use:Multi-unit residential development.

Applicant(s):Domenic Spenser; c/o Robert Artrup, Agent; 3141 Polley Road; Columbus, OH 43221.

Property Owner(s):ASMRE Holdings, LLC; c/o Patrick Shivley; 4525 Harbor Boulevard; Columbus, OH 43232.

Planner:Eastman Johnson; 614-645-7979; roejohnson@columbus.gov <<mailto:roejohnson@columbus.gov>>

6.APPLICATION:[Z23-031 <https://portal.columbus.gov/permits/urlrouting.ashx?type=1000&Module=Zoning&capID1=23LAC&capID2=00000&capID3=00521&agencyCode=COLUMBUS&HideHeader=true>](https://portal.columbus.gov/permits/urlrouting.ashx?type=1000&Module=Zoning&capID1=23LAC&capID2=00000&capID3=00521&agencyCode=COLUMBUS&HideHeader=true)

Location:2480-2484 FOREST GREEN CT. (43232), being 6.2± acres located on the west side of Weyburn Road, 140± feet north of Marlin Drive (010-027889; Mideast Area Commission).

Existing Zoning:PUD-8, Planned Unit Development District.

Request:ARLD, Apartment Residential District (H-60).

Proposed Use:Multi-unit residential development.

Applicant(s): Domenic Spenser; c/o Robert Artrup, Agent; 3141 Polley Road; Columbus, OH 43221.

Property Owner(s):BYOBYO, LLC; c/o Eric Ward; 7049 Riverside Drive; Dublin, OH 43016.

Planner:Eastman Johnson; 614-645-7979; roejohnson@columbus.gov <<mailto:roejohnson@columbus.gov>>

Legislation Number: PN0229-2023

Drafting Date: 7/27/2023

Current Status: Clerk's Office for Bulletin

Version: 1

Matter Type: Public Notice

Notice/Advertisement Title: To amend Chapter 248 of the Columbus City Health Code

Contact Name: Christina Wilson

Contact Telephone Number: 614-645-6197

Contact Email Address: christinaw@columbus.gov

The following resolution was approved at the July 18th 2023 Columbus Board of Health meeting.

To amend Chapter 248 of the Columbus City Health Code to prohibit tobacco retailers from selling flavored tobacco products, including menthol cigarettes.

WHEREAS, tobacco use remains the leading cause of preventable death in the United States, killing nearly half a million people each year. It causes or contributes to many forms of cancer, as well as heart disease and respiratory diseases, among other health disorders; and

WHEREAS, the Centers for Disease Control and Prevention estimates that more than 2 million U.S. middle and high school students reported currently using e-cigarettes in 2021, with more than 8

in 10 of those youth using flavored e-cigarettes; and

WHEREAS, every day, about 2,500 children in the United States try their first cigarette, and another 400 children under 18 years of age become new regular daily smokers. 81% of youth who have ever used a tobacco product reported that the first tobacco product they used was flavored; and

WHEREAS, the Centers for Disease Control and Prevention reported a more than 800% increase in electronic cigarette use among middle school and high school students between 2011 and 2015 alone; and

WHEREAS, nicotine solutions, which are consumed via electronic smoking devices such as electronic cigarettes, are sold in thousands of flavors that appeal to youth, such as cotton candy, bubble gum, banana smash and mango ice; and

WHEREAS, data from the 2019 Ohio Youth Tobacco Survey indicates that nearly one out of our Ohio high school students and nearly 13% of Ohio middle school students reported having used a flavored tobacco product; and

WHEREAS, the Centers for Disease Control and Prevention finds that while cigarette smoking among American adults declined overall, Columbus Public Health has seen an 8% increase in smoking rates for African American adults in Franklin County; and

WHEREAS, the City of Columbus has declared racism to be a public health crisis and is committed to working to address minority health inequities; and

WHEREAS, it is in the best interest of all parties to protect young people from flavored tobacco products, these products also disproportionately impact the 85% of African American smokers and 36% of LGBTQ smokers who smoke menthols as a result of targeted marketing practices; and

WHEREAS, the current City Health Code does not define flavored tobacco products nor prohibit their sale; and

WHEREAS, Columbus Public Health is solely responsible for enforcing the City Health Code requirements pertaining to tobacco retailers; and

WHEREAS, amending the City Health Code to prohibit the sale of flavored tobacco products will benefit the health of the residents of the City of Columbus, particularly its youth;

NOW, THEREFORE, BE IT RESOLVED BY THE COLUMBUS BOARD OF HEALTH:

SECTION 1. That existing Sections 248.01, 248.02, 248.03, 248.04 and 248.05 of the Columbus City Health Code be replaced as follows:

248.01 DEFINITIONS

As used in this Chapter:

(A) "Department" means Columbus City Health Department and its authorized employees and agents.

(B) "Electronic Smoking Device" means any device that can be used to deliver aerosolized or vaporized nicotine or any other substance to the person inhaling from the device, including, but not limited to, an electronic cigarette, electronic cigar, electronic pipe, vaping pen or electronic hookah. "Electronic Smoking Device" includes any component, part, or accessory of such a device, whether or not sold separately, and includes any substance that may be aerosolized or vaporized during the use of the device. "Electronic Smoking Device" does not include drugs, devices, or combination products authorized for sale as a cessation product by the U.S. Food and Drug Administration, as those terms are defined in the Federal Food, Drug and Cosmetic Act.

(C) "Flavored Shisha Tobacco Product" means a Flavored Tobacco Product smoked or intended to be smoked in a Hookah. "Flavored Shisha Tobacco Product" includes, and may be referred to as, Hookah tobacco, waterpipe tobacco, maassel, narghile, and argileh.

(D) "Flavored tobacco product" means any Tobacco Product that imparts a taste or smell, other than the taste or smell of tobacco, that is distinguishable by an ordinary consumer either prior to, or during the consumption of, a Tobacco Product, including, but not limited to, any taste or smell relating to any fruit, chocolate, vanilla, honey, candy, cocoa, dessert, alcoholic beverage, menthol, mint, wintergreen, herb, or spice. There shall be a rebuttable presumption that a Tobacco Product is a "Flavored Tobacco Product" if:

- (1) The Tobacco Product uses text or images, or both, on the Tobacco Product's labeling or packaging to explicitly or implicitly indicate that the Tobacco Product imparts a taste or smell other than tobacco; or
- (2) A public statement or claim made or disseminated by the manufacturer or retailer of a Tobacco Product, or by any person authorized or permitted by the manufacturer or retailer to make or disseminate public statements concerning such Tobacco Product, that such Tobacco Product has or produces a taste or smell other than tobacco; or
- (3) There are actions directed to consumers that would reasonably be expected to cause consumers to believe that the Tobacco Product imparts a taste or smell other than tobacco.

(E) "Hookah" means a type of water pipe that is used to smoke Flavored Shisha Tobacco Products, which has a long, flexible tube to draw aerosol through water. This device has components that may include heads, stems, bowls, and hoses.

(F) "Licensee" means a Retailer that has been issued a Retail Tobacco Product Sales license or a Temporary Retail Tobacco Product Sales license for a Retail Tobacco Establishment by the Department.

(G) "Person" means any individual, firm, corporation, business trust, estate, trust, association, syndicate, partnership, cooperative, governmental agency or any other entity recognized by law. "Person" does not include a wholesale dealer as defined in section 5743.01(B) of the Ohio Revised Code, a distributor as defined in section 5743.01(K)(2) or (K)(3) of the Ohio Revised Code, or a vapor distributor as defined in section 5743.01 (V)(1), (V)(4) or (V)(5) of the Ohio Revised Code when the dealer or distributor is acting in a dealer or distributor capacity.

(H) "Proof of Age" means a driver's license, a commercial driver's license, a military identification card, a passport, or an identification card issued under Sections 4507.50 to 4507.52 of the Ohio Revised Code demonstrating that the recipient or purchaser is at least twenty-one (21) years of age.

(I) "Retailer" means any person engaged in the business of Retail Tobacco Product Sales or Temporary Retail Tobacco Product Sales.

(J) "Retail Tobacco Establishment" means the location of any physical place of business or section of a physical place of business where Retail Tobacco Product Sales or Temporary Retail Tobacco Product Sales are made. The term shall include those portions of any physical place of business where vending machines that dispense Tobacco Products are located.

(K) "Retail Tobacco Product Sales" means the act of giving, selling or otherwise distributing Tobacco Products in a retail setting, including but not limited to, gas stations, convenience stores, carry out markets, groceries, supermarkets, retail warehouse clubs, drug stores, liquor stores, vape shops, and hookah bars or lounges.

(L) "Temporary Retail Tobacco Product Sales" means the act of giving, selling or otherwise distributing Tobacco Products at an event for not more than thiiy consecutive days.

(M) "Tobacco Product" means any product that is made from or derived from tobacco or that contains any form

of nicotine, natural or synthetic, that is intended for human consumption or is likely to be consumed, whether smoked, heated, chewed, absorbed, dissolved, inhaled or ingested by any other means, including, but not limited to, a cigarette, an electronic smoking device, a cigar, little cigars, pipe tobacco, chewing tobacco, smokeless tobacco, snuff, or snus. The term "Tobacco Product" also means any component or accessory used in the consumption of a Tobacco Product, such as filters, rolling papers, pipes, blunt or hemp wraps, hookahs, flavor enhancers, mouthpieces, and pipes and substances used in Electronic Smoking Devices, whether or not they contain nicotine. "Tobacco product" does not include drugs, devices, or combination products authorized for sale as a cessation product by the U.S. Food and Drug Administration, as those terms are defined in the Federal Food, Drug and Cosmetic Act.

(N) "Underage Buy Attempt" means an individual, authorized by the Department, who is 1) under the age of 21 and requests purchase of Tobacco Products at a Retail Tobacco Establishment; or 2) under the age of 30 and requests purchase of Tobacco Products at a Retail Tobacco Establishment without presenting proof of age as defined in section 248.05.

(O) "Vending Machine" means any mechanical or electronic device designed to do both of the following:

- (1) Receive a coin, bill, token, credit card, or other electronic payment including, but not limited to, a card, code, device, or other means of access to a customer's account, made for that purpose;
- (2) In return for the insertion or deposit of a coin, bill, token, credit card, or other electronic payment automatically dispenses product, provides a service, or grants a license.

248.02 LICENSE APPLICATION

(A) A Retailer of Tobacco Products shall apply for a valid Retail Tobacco Product Sales license or a Temporary Retail Tobacco Product Sales license. Retail Tobacco Product Sales licenses shall be issued by the Department annually. Temporary Retail Tobacco Product Sales licenses shall be valid for not longer than thirty consecutive days. A license shall be required for each Retail Tobacco Establishment where Retail Tobacco Product Sales, including Temporary Retail Tobacco Product Sales, are conducted and is non-transferable.

(B) A Retailer applying for a Retail Tobacco Product Sales license or a Temporary Retail Tobacco Product Sales license shall submit a current and valid vendor's license as required by the Ohio Department of Taxation to the Department. Any Retailer who distributes, stores, or sells cigarettes shall submit a current and valid Retail Cigarette Dealer's License as required by Ohio Revised Code Chapter 5743 to the Department prior to approval for licensing. Any Retailer who permits smoking inside the Retail Tobacco Establishment they are seeking to have licensed shall submit a current and valid retail tobacco store exemption issued by the Ohio Department of Health as per Ohio Revised Code §3794.03 prior to licensing. Any Retailer who permits vaping inside the Retail Tobacco Establishment they are seeking to have licensed shall provide a current and valid Ohio Department of Health affidavit stating the percentage of the establishment's gross income during the prior calendar year that was derived from the sale of vapor products, Electronic Smoking Devices, or other electronic smoking product accessories as per Ohio Revised Code §3794.03 prior to licensing.

(C) The annual Retail Tobacco Product Sales license fee shall be Three Hundred Fifty Dollars (\$350.00). The license shall be valid beginning on the first day of October of the year issued through the last day of September of the following year. A license issued to a new Licensee after the first day of July and before the first day of October shall not expire until the last day of September of the following year. A penalty equal to twenty-five percent (25%) of the applicable license fee shall be assessed by the Department for license fee payments that are not received or postmarked by the first day of October.

(D) The Temporary Retail Tobacco Product Sales license fee shall be Fifty Dollars (\$50.00). The license shall be valid for no longer than thirty (30) consecutive days and limited to a single event. The application shall be made at

least ten days prior to the event.

(E) License fees are due at the time of application and are not refundable.

248.03 LICENSE APPLICATION DENIAL, RENEWAL DENIAL, SUSPENSION, AND REVOCATION

(A) Applications for Retail Tobacco Product Sales licenses and Temporary Retail Tobacco Product Sales licenses may be denied, and existing licenses may be suspended or revoked, for any of the following:

- (1) The applicant or Licensee, or any agent, employee, or representative thereof, is giving, selling, or offering to sell Tobacco Products by or from a Vending Machine.
- (2) Observation by staff of the Department or its authorized agent that the applicant or Licensee, or any agent, employee, or representative thereof has violated provisions of Chapter 248 of the Columbus City Health Code or provisions of Chapter 715 of the Columbus City Codes.
- (3) Failure by the Licensee to post signage as required by Section 248.04 of the Columbus City Health Code.
- (4) The applicant or Licensee having a conviction for violating former Section 2329.13 or Section 2329.14 of the Columbus City Codes; having a conviction for violating any provision of the Ohio Revised Code or Ohio Administrative Code pertaining to the regulation of Tobacco Products or to indoor smoking or vaping; or having a finding of violation of any provision of Chapter 248 of the Columbus City Health Code within two years prior to the date of issuance or at any time during the licensing year .
- (5) A finding by a court of competent jurisdiction that a Retail Tobacco Establishment owned and/or operated by the applicant or Licensee constitutes a public nuisance or that the location of the Retail Tobacco Establishment that is the subject of the application or license has been found, by a court of competent jurisdiction, to be a public nuisance during the period that the court retains jurisdiction over the nuisance action.
- (6) Information contained in the application is misleading, inaccurate, or false.
- (7) The applicant or Licensee, or any agent, employee, or representative thereof, fails to comply with U.S. Food and Drug Administration regulations, Ohio Revised Code, Ohio Administrative Code, and/or city codes relating to building, health and fire.
- (8) The applicant or Licensee has outstanding fines, issued pursuant to Columbus City Health Code Chapter 248.

(B) Any Licensee whose Retail Tobacco Product Sales license or Temporary Retail Tobacco Product Sales license has been proposed to be suspended or revoked shall be notified in writing by the Department. Appeals of such action may be made in accordance with Columbus City Health Code §203.10.

(C) Any applicant whose application for a Retail Tobacco Product Sales license or Temporary Retail Tobacco Product Sales license is denied shall be notified in writing by the Department. Appeals of such action may be made in accordance with Columbus City Health Code §203.08.

248.04 SIGN DISTRIBUTION AND POSTING

(A) The Department shall make signs available to all Retail Tobacco Product Sales Licensees, and Temporary Retail Tobacco Product Sales Licensees. Signs shall be provided by the Department at the time of license approval or renewal, and upon request.

(B) The Licensee shall post the signs provided by the Department, which include notice of the legal sales age and Proof of Age verification requirement provided for in Section 248.05, in each Retail Tobacco Establishment within 6 feet of each cash register or place where payment may be made in a place conspicuous to both employees and customers and where the sign is unobstructed in its entirety. The sign shall state, "NO PERSON UNDER THE AGE OF 21 MAY BE SOLD TOBACCO PRODUCTS INCLUDING ELECTRONIC SMOKING DEVICES." The

sign required shall be at least 6 by 4 inches and the words on the sign must be legibly printed in high contrast red color with capitalized letters at least 0.3 inches high.

248.05 ILLEGAL DISTRIBUTION

(A) No Licensee, or any agent, employee, or representative of a Licensee shall do any of the following at a Retail Tobacco Establishment:

- (1) Give, sell, or otherwise distribute Tobacco Products to any individual under 21 years of age.
- (2) Give, sell, or otherwise distribute Tobacco Products without viewing Proof of Age demonstrating the recipient is at least 21 years of age, except that no such verification is required for a recipient over the age of 30. That an individual appeared to be over the age of 30 shall not constitute a defense to a violation of this section.
- (3) Give, sell, or otherwise distribute Tobacco Products while under a license suspension as provided for in Section 248.03.
- (4) Give, sell, or otherwise distribute flavored tobacco products.
- (5) Give, sell or offer to sell Tobacco Products by or from a Vending Machine.

(B) Subsection 4 does not apply to the retail sale of Flavored Shisha Tobacco Products.

SECTION 2. That existing Sections 248.01, 248.02, 248.03, 248.04 and 248.05 of the Columbus City Health Code be repealed.

SECTION 3. That existing Section 248.06 of the Columbus City Health Code be replaced as follows:

248.06 ENFORCEMENT AND CIVIL PENALTY

(A) The Department shall enforce all applicable provisions of this Chapter and all regulations adopted pursuant hereto.

(B) The Department may conduct inspections, which may include Underage Buy Attempts and/or Flavored Tobacco Product buy attempts, for all Retail Tobacco Establishments within the City of Columbus that have Retail Tobacco Product Sales licenses.

(C) The Department may conduct inspections which may include Underage Buy Attempts and/or Flavored Tobacco Product buy attempts, during Temporary Retail Tobacco Product Sales Licensee's events.

(D) If the Department observes a violation(s) of this Chapter at a Retail Tobacco Establishment that has a Retail Tobacco Product Sales license or Temporary Retail Tobacco Product Sales license, the following schedule of civil penalties shall be imposed on the Licensee, in addition to the sanctions specified in Section 248.03(A):

- (1) For a first violation, a fine of \$1,000.00.
- (2) For a second violation within two years of the first violation, a fine of \$5,000.00 per violation.
- (3) For a third and any subsequent violations within two years of the first violation:
 - (a) a fine of \$10,000.00 per violation; and
 - (b) revocation of any existing Retail Tobacco Product Sales license or Temporary Retail Tobacco Product Sales license and imposition of a two year ineligibility to obtain a Retail Tobacco Product Sales license or Temporary Retail Tobacco Product Sales license; and

(E) If the Department observes a violation(s) of any of the provisions of Chapter 715 of the Columbus City Codes, the following schedule of civil penalties shall be imposed:

- (1) For a first violation, a fine of \$1000.00.
- (2) For a second violation within two years of the first violation, a fine of \$5000.00 per violation.
- (3) For a third and any subsequent violation within two years of the first violation, a fine of \$10,000 and the

person shall not be eligible to obtain a Retail Tobacco Product Sales License or a Temporary Retail Tobacco Product Sales License for a period of three licensing-years.

(F) Civil penalties issued pursuant to this section may be appealed in accordance with Columbus City Health Code §203.08.

SECTION 4. That existing Section 248.06 of the Columbus City Health Code be repealed.

SECTION 5. That **SECTION 1** and **SECTION 2** of this resolution shall take effect and be in full force January 1, 2024.

SECTION 6. That **SECTION 3** and **SECTION 4** of this resolution shall take effect and be in full force April 1, 2023.

Legislation Number: PN0230-2023

Drafting Date: 8/1/2023

Current Status: Clerk's Office for Bulletin

Version: 1

Matter Type: Public Notice

Notice/Advertisement Title: Property Maintenance Appeals Board - August 14, 2023

Contact Name: Toni Gillum

Contact Telephone Number: (614) 645-5884

Contact Email Address: tmgillum@columbus.gov <<mailto:tmgillum@columbus.gov>>

AGENDA

PROPERTY MAINTENANCE APPEALS BOARD

CITY OF COLUMBUS, OHIO

AUGUST 14, 2023

The Property Maintenance Appeals Board shall hear and decide appeals from any persons affected by any order, requirement, decision or determination made in the administration or enforcement of the Health, Sanitation and Safety Code, this Housing Code, and as specifically provided in any other provision of the Columbus City Codes. Separately, the Property Maintenance Appeals Board will review requests to permit a reasonable minimum variance from the applicable section of the Housing Code.

The City PROPERTY MAINTENANCE APPEALS BOARD will hold a public hearing on the following appeal and/or variance applications on **MONDAY, AUGUST 14, 2023 at 1:00 p.m.** at the **MICHAEL B. COLEMAN GOVERNMENT CENTER-PARKING GARAGE** at 141 North Front Street, Columbus, OH 43215 in the 1ST FLOOR CONFERENCE ROOM.

SPECIAL NOTE TO APPELLANT: YOU OR YOUR REPRESENTATIVE MUST ATTEND THIS MEETING.

The Board may move forward and render a decision on an appeal, even if the appellant is not present.

SIGN LANGUAGE INTERPRETER: A Sign Language Interpreter, to "Sign" this meeting, will be made available for anyone with a need for this service, provided the Department of Building & Zoning Services is made aware of this need and given a reasonable notice of at least forty-eight (48) hours prior to the scheduled meeting time. To schedule an interpreter, please call 614-645-6373 or TDD 614-645-3293.

ADA ACCOMMODATION: It is the policy of the City of Columbus that all City-sponsored public meetings and events are accessible to people with disabilities. If you need assistance in participating in this meeting due to a disability as defined under the ADA, please call the City's ADA Coordinator at 614-645-7206 at least three (3) business days prior to the scheduled meeting to request an accommodation.

01. Application Number: PMA-515

Appellant(s): Samuel Buford, property owner

Property Location: 545 Hanford St.

Request: Appeal

Violation Notice: 23475-07438

Code Enforcement Officer: Jacklyn Martin

02. Application Number: PMA-516 *APPEAL WITHDRAWN, PER 7/17/23 EMAIL*

Appellant(s): Ethan Temianka, Founder/CEO Patriarch Enterprises, LLC

Property Location: 711 Mithoff St.

Request: Appeal

Violation Notice: 23441-00518

Code Enforcement Officer: Jacklyn Martin

03. Application Number: PMA-517 *REQUEST TO TABLE TO 9/11/23 SUBMITTED 7/25/23 VIA EMAIL-APPROVED*

Appellant(s): Elizabeth A. Petty, VP of Dennison Avenue, LLC

Property Location: 936-38 Dennison Ave.

Request: Appeal

Violation Notice: 23440-04387

Code Enforcement Officer: Valentine Gleich

04. Application Number: PMA-518

Appellant(s): Gary Schuen, on behalf of Barbara Fabeck

Property Location: 431 Marion Rd.

Request: Appeal

Violation Notice: 23450-01009

Code Enforcement Officer: Jacklyn Martin

05. Discussion of Bylaws, Section C, subsection ii.

Cancellation - if there are no appeals or other business to be heard by the Board, the Chair may cancel a regular meeting by notice to all members not less than forty-eight (48) hours prior to the regular meeting.

Public notice of the cancellation shall also be made.

06. ANNUAL NOMINATIONS AND VOTING FOR BOARD POSITIONS: CHAIR AND VICE CHAIR

Legislation Number: PN0232-2023

Drafting Date: 8/2/2023

Current Status: Clerk's Office for Bulletin

Version: 1

Matter Type: Public Notice

Notice/Advertisement Title: City of Columbus January 17, 2023 Graphics Commission Meeting

Contact Name: Jamie Freise

Contact Telephone Number: 614-645-6350

Contact Email Address: jffreise@columbus.gov <<mailto:jffreise@columbus.gov>>

AGENDA

GRAPHICS COMMISSION

CITY OF COLUMBUS, OHIO

AUGUST 15, 2023

The City Graphics Commission hears requests for Variances, Special Permits, Appeals, Graphics Plans and certain Miscellaneous Graphics, as provided by the Columbus Graphics Code, Title 33, Article 15 of the City Codes.

The City Graphics Commission will hold a public hearing on the following zoning applications on **TUESDAY, AUGUST 15, 2023 at 4:15 p.m.** at the **MICHAEL B. COLEMAN GOVERNMENT CENTER** at 111 North Front Street, Columbus, OH 43215 in the 2ND FLOOR HEARING ROOM. You can also monitor the hearing through the City of Columbus YouTube channel at the following link: <http://www.youtube.com/cityofcolumbus>

SPECIAL NOTE TO APPLICANT: YOU OR YOUR REPRESENTATIVE MUST ATTEND THIS MEETING. It is the rule of the Commission to withdraw an application when a representative is not present.

SIGN LANGUAGE INTERPRETER: A Sign Language Interpreter, to “Sign” this meeting, will be made available for anyone with a need for this service, provided the Department of Building & Zoning Services is made aware of this need and given a reasonable notice of at least forty-eight (48) hours prior to the scheduled meeting time. To schedule an interpreter, please call 614-645-6373 or TDD 614-645-3293

Further information may be obtained by visiting the City of Columbus Zoning Office website at <https://www.columbus.gov/bzs/zoning/Graphics-Commission/> or by calling the Department of Building and Zoning Services, Council Activities Section at 614-645-4522

01.Application No.:GC23-014

Location:8200 E. BROAD ST (43268), located on the northeast corner of East Broad Street and Cedar Cliff. (515-273199; Far East Area Commission).

Existing Zoning:L-C-4, Commercial District

Request:Variance(s) to Section(s):3377.18 (B), Permanent on-premises projecting signs.To allow an individual projecting sign in addition to a ground sign that services the entire use/building.
3375.15 (B), Banner standards.To increase the display time for temporary banners from 30 days to 180.
3375.15 (C), Banner standards.To increase the maximum banner area from 16 square feet to 144 square feet.

Proposal:To install wall signs and banners for the grand opening a of a retail store.

Applicant(s):Zoning Resources, c/o Rebecca Green84 Skyline Dr.South Bloomfield, Ohio 43103

Property Owner(s):SWG-Reynoldsburg LLC3715 Northside PW #4-325Atlanta, Georgia 30327

Attorney/Agent:Applicant

Planner: Adam Trimmer, (614) 645-1469; ADTrimmer@Columbus.gov

02.Application No.:GC23-021

Location:855 W. 3rd AVE. (43212), located at the southwest corner of West 3rd Avenue and Yard Street (010-298384; 5th by Northwest Area Commission).

Existing Zoning:M, Manufacturing District

Request:Special Permit(s) to Section(s):3378.01, General provisions.To grant a Special Permit for an off-premises graphic.

Proposal:To install an off-premises wall sign.

Applicant(s):855 Third Ave., LLC375 North Front StreetColumbus, Ohio 43215

Property Owner(s):NRI Equity Land Investments, LLC375 North Front StreetColumbus, Ohio 43215

Attorney/Agent:SignCom, Inc., c/o Niels Braam527 West Rich StreetColumbus, Ohio 43215

Planner:Jamie Freise, (614) 645-6350; JFFreise@Columbus.gov

03.Application No.:GC23-022

Location:4661 MORSE RD. (43229), located at the northwest corner of Morse Road and Northtowne Boulevard (010-245370; Northland Community Council).

Existing Zoning:CPD, Commercial Planned Development District

Request:Variance(s) to Section(s):3377.20 (D), Permanent on-premises wall and window signs.
To increase the aggregate graphic area allowed from 374 square feet to 505 square feet.

3377.23, Permanent and removable window signs.To increase the total window coverage from 25 percent of the area of the windows with which they are associated to 100 percent.

Proposal:To legitimize all exterior graphics.

Applicant(s):Guitar Center4661 Morse RoadColumbus, Ohio 43229

Property Owner(s): MC-NC, LLC12295 Olive BoulevardSt. Louis, Missouri 63141

Attorney/Agent:Expedite the Diehl, LLC, c/o Tracey Diehl6487 Hilliard DriveCanal Winchester, Ohio 43110

Planner:Jamie Freise, (614) 645-6350; JFFreise@Columbus.gov

Legislation Number: PN0233-2023

Drafting Date: 8/2/2023

Current Status: Clerk's Office for Bulletin

Version: 1

Matter Type: Public Notice

Notice/Advertisement Title: Fifth by Northwest Area Commission August Meeting Changes

Contact Name: Bill Colgan, Chair

Contact Email Address: fifthxnw@gmail.com

The Fifth by Northwest Area Commission has moved their August 1 general meeting to Tuesday, August 8 at 7:00 p.m. Their meeting location will also change; they will meet at North Side Neighborhood Pride Center, 248 E 11th Ave, Columbus OH 43201.

Please direct questions regarding the Fifth by Northwest Area Commission to Bill Colgan at fifthxnw@gmail.com

Legislation Number: PN0234-2023

Drafting Date: 8/2/2023

Current Status: Clerk's Office for Bulletin

Version: 1

Matter Type: Public Notice

Notice/Advertisement Title: Columbus Building Commission Agenda -August 15, 2023

Contact Name: Toni Gillum

Contact Telephone Number: (614) 645-5884

Contact Email Address: tmgillum@columbus.gov

**AGENDA
COLUMBUS BUILDING COMMISSION
AUGUST 15, 2023
111 N. FRONT STREET
2ND FLOOR HEARING ROOM
1:00 p.m.**

The City of Columbus Building Commission will hold a public hearing for the following agenda items on Tuesday, August 15, 2023, beginning at 1:00 P.M.

1. **ROLL CALL**
2. **APPROVAL OF MEETING MINUTES**
3. **ADJUDICATION ORDER: A/O2023-DMGR2204412**
APPLICANT: JM ROBERTS, LLC
PROPERTY ADDRESS: 228 BELVEDERE AVE
OWNER: MATTHEW/JESSICA ROBERTS
4. **APPLICATIONS FOR SPECIAL INSPECTOR**
5. **ADJOURNMENT**

Meeting Accommodations: It is the policy of the City of Columbus that all City-Sponsored public meetings and events are accessible to people with disabilities. If you need assistance in participating in this meeting or event due to a disability as defined under the ADA, please call the City's ADA Coordinator at (614) 645-7206 at least three (3) business days prior to the scheduled meeting or event to request an accommodation.

Legislation Number: PN0235-2023

Drafting Date: 8/2/2023

Current Status: Clerk's Office for Bulletin

Version: 1

Matter Type: Public Notice

Notice/Advertisement Title: 2023 Civilian Police Review Board: Investigation Review Committee Meetings

Contact Name: Stephanie Brock

Contact Telephone Number: 614-645-9601

Contact Email Address: Civilianreviewboard@columbus.gov <<mailto:Civilianreviewboard@columbus.gov>>

Civilian Police Review Board

2023 Investigation Review Committee Meetings

NOTICE OF REGULAR MEETINGS

CIVILIAN POLICE REVIEW BOARD: Investigation Review Committee Meetings

The Civilian Police Review Board, appointed and organized under the Charter of the City of Columbus, Section 235.02 is empowered promulgate rules and regulations, in accordance with C.C.C. Section 121.05 to carry out its duties as provided for in the Charter and in this chapter. In addition, said Commission exercises certain powers and duties as specified in Sections 235.03 of the Columbus City Charter.

Please take notice that meetings of the Civilian Police Review Board Investigation Review Committee Meetings will be held at the following dates and locations (unless otherwise posted):

Review Board Investigation Review Committee #1 Meetings

Thursday, August 24, 2023 @ 10:00a - Vineyard Columbus, 6000 Cooper Rd.

September - TBD

October - TBD

November - TBD

December - TBD

Review Board Investigation Review Committee #2 Meetings

August - TBD

September - TBD

October - TBD

November - TBD

December - TBD

Review Board Investigation Review Committee #3 Meetings

Tuesday, August 15, 2023 @ 6:00p - MLK Library, 1467 E. Long St

September - TBD

October - TBD

November - TBD

December - TBD

In the event no proper business exists the meeting may be cancelled without further notice. For further information you

may contact the Board's Executive Assistant, Stephanie Brock. Telephone: (614-645-9601), or at Email: Civilianreviewboard@columbus.gov <<mailto:Civilianreviewboard@columbus.gov>>

Brooke Burns, Chair
Civilian Police Review Board

Legislation Number: PN0236-2023

Drafting Date: 8/2/2023

Current Status: Clerk's Office for Bulletin

Version: 1

Matter Type: Public Notice

Notice/Advertisement Title: Communications08022023

Contact Name: Charmaine Chambers

Contact Telephone Number: (614) 645-6553

Contact Email Address: cdchambers@columbus.gov

THE FOLLOWING COMMUNICATIONS WERE RECEIVED BY THE CITY CLERK'S OFFICE AS OF WEDNESDAY, AUGUST 2, 2023.

Transfer Type: D1 D2 D3 D3A D6

To: Rudy Times Two LLC

DBA District West

1025 E 5th Ave

Columbus, OH 43201

From: Rudy Times Two LLC

145 N 5th St & Patio

Columbus, OH 43215

Permit #: 75801450001

New Type: D3

To: Betterton Co LLC

DBA Double Happy & Bumbles Backyard

1280 Brown Rd

Columbus, OH 43223

Permit #: 0672379

New Type: D3 D3A

To: Cave Bar & Lounge LLC

122 E Main St 3rd Fl

Columbus, OH 43215

Permit #: 14054110010

Advertise Date: 8/5/23

Return Date: 8/15/23

Legislation Number: PN0290-2022

Drafting Date: 10/24/2022

Current Status: Clerk's Office for Bulletin

Version: 1

Matter Type: Public Notice

Notice/Advertisement Title: City of Columbus Records Commission- Meeting Schedule 2023

Contact Name: Monique L. Goins-Ransom, Records Commission Coordinator

Contact Telephone Number: 614-645-0845

Contact Email Address: mlgoins-ransom@columbus.gov

CITY OF COLUMBUS RECORDS COMMISSION MEETING SCHEDULE 2023:

The regular meetings of the City of Columbus Records Commission for the calendar year 2023 are scheduled as follows:

Monday, February 13, 2023

Monday, May 15, 2023

Monday, September 18, 2023

Meetings will take place at: **City Hall, 90 West Broad Street, 2nd Floor, in the City Council Conference Room 225.**
They will begin promptly at 10:00 am.

Every effort will be made to adhere to the above schedule, but the City of Columbus Records Commission reserves the right to change the date, time or location of any meeting; or to hold additional meetings. To confirm the meeting date, time and locations or to obtain agenda information, contact Monique Goins-Ransom the City of Columbus Records Commission Coordinator at (614) 645-0845.

Legislation Number: PN0334-2022

Drafting Date: 11/17/2022

Version: 1

Current Status: Clerk's Office for Bulletin

Matter Type: Public Notice

Notice/Advertisement Title: Victorian Village Commission 2023 Meeting Schedule

Contact Name: Kimberly Barnard-Sheehy

Contact Telephone Number:

Contact Email Address: VVC@columbus.gov

It is the policy of the City of Columbus that all City-sponsored public meetings and events are accessible to people with disabilities. If you need assistance in participating in this meeting or event due to a disability as defined under the ADA, please call the City's ADA Coordinator at (614) 645-8871 or e-mail zdjones@columbus.gov at least three (3) business days prior to the scheduled meeting or event to request an accommodation.

Application Deadline^^
(VVC@columbus.gov)*
4:00p.m.

Business Meeting Date**
(111 N. Front St., 2nd Fl. Rm. 204)+
12:00p.m.

Hearing Date**
(111 N. Front St., 2nd Fl. Rm.204)+
4:00p.m.

December 15, 2022
January 12, 2023

December 28, 2022
January 25, 2023

January 11, 2023
February 8, 2023

February 9, 2023	February 22, 2023	March 8, 2023
March 16, 2023	March 29, 2023	April 12, 2023
April 13, 2023	April 26, 2023	May 10, 2023
May 18, 2023	May 31, 2023	June 14, 2023
June 15, 2023	June 28, 2023	July 12, 2023
July 13, 2023	July 26, 2023	August 9, 2023
August 17, 2023	August 30, 2023	September 13, 2023
September 14, 2023	September 27, 2023	October 11, 2023
October 12, 2023	October 25, 2023	November 8, 2023
November 16, 2023	November 29, 2023	December 13, 2023
December 14, 2023	December 27, 2023	January 10, 2024

* If you are unable to email, call 614-724-4437 to request alternative delivery options

**Meetings subject to cancellation and locations subject to change. Please contact staff to confirm. Meeting dates, times and locations are also available at www.columbus.gov/planning. The Hearing time changed to 4:00 p.m. in July 2021.

^Date change due to holiday.

NOTE: For application deadlines that fall within the same week as the regular meeting date, a grace period of one (1) week is available for applications heard at the previous month's Hearing. (i.e. An application heard at the June Hearing may be granted the grace period to make any applicable revisions and apply for the July Hearing.)

The grace period does not apply to months with additional weeks whereby the application deadline naturally falls at least one (1) week after the regular meeting.

Legislation Number: PN0335-2022

Drafting Date: 11/17/2022

Current Status: Clerk's Office for Bulletin

Version: 1

Matter Type: Public Notice

Notice/Advertisement Title: University Impact District Review Board 2023 Meeting Schedule

Contact Email Address: UIDRB@columbus.gov

Meeting Accommodations: It is the policy of the City of Columbus that all City-sponsored public meetings and events are accessible to people with disabilities. If you need assistance in participating in this meeting or event due to a disability as defined under the ADA, please call the City's ADA Coordinator at (614) 645-8871 or e-mail zdjones@columbus.gov at least three (3) business days prior to the scheduled meeting or event to request an accommodation.

Application Deadline^^ (uidrb@columbus.gov)*	Business Meeting** (111 N. Front St. Rm. #204) 12:00pm	Regular Meeting** (111 N. Front St. Rm. #204) 4:00pm
December 30, 2022	January 12, 2023	January 26, 2023
January 27, 2023	February 9, 2023	February 23, 2023
February 24, 2023	March 9, 2023	March 23, 2023
March 31, 2023	April 13, 2023	April 27, 2023
April 28, 2023	May 11, 2023	May 25, 2023
May 26, 2023	June 8, 2023	June 22, 2023

June 30, 2023	July 13, 2023	July 27, 2023
July 28, 2023	August 10, 2023	August 24, 2023
September 1, 2023	September 14, 2023	September 28, 2023
September 29, 2023	October 12, 2023	October 26, 2023
October 27, 2023	November 9, 2023	November 20, 2023 [^]
December 1, 2023	December 14, 2023	December 18, 2023 [^]

* If you are unable to email, call 614-724-4437 to request alternative delivery options

**Meetings subject to cancellation. Please contact staff to confirm dates and Room location for Business Meetings. Meeting dates, times and locations are also available at www.columbus.gov/planning

[^]Date and location change due to holiday

^{^^}NOTE: For application deadlines that fall within the same week as the regular meeting date, a grace period of one (1) week is available for applications heard at the previous month's Hearing. (i.e. An application heard at the June Hearing may be granted the grace period to make any applicable revisions and apply for the July Hearing.)

The grace period does not apply to months with additional weeks whereby the application deadline naturally falls at least one (1) week after the regular meeting.

Legislation Number: PN0336-2022

Drafting Date: 11/17/2022

Current Status: Clerk's Office for Bulletin

Version: 1

Matter Type: Public Notice

Notice/Advertisement Title: Rocky Fork-Blacklick Accord 2023 Meeting Schedule

Contact Name: Nolan Harshaw

Contact Telephone Number: 614.645.1995

Contact Email Address: nmharshaw@columbus.gov

Meeting Accommodations: It is the policy of the City of Columbus that all City-sponsored public meetings and events are accessible to people with disabilities. If you need assistance in participating in this meeting or event due to a disability as defined under the ADA, please call the City's ADA Coordinator at (614) 645-8871 or e-mail zdjones@columbus.gov at least three (3) business days prior to the scheduled meeting or event to request an accommodation.

Application Deadline^{^^} Hearing Dates^{**}
planninginfo@columbus.gov* <<mailto:planninginfo@columbus.gov>>* (New Albany Village Hall)+

December 23, 2022/January 19, 2023
 January 20, 2023/February 16, 2023
 February 17, 2023/March 16, 2023
 March 24, 2023/April 20, 2023
 April 21, 2023/May 18, 2023
 May 19, 2023/June 15, 2023
 June 23, 2023 July 20, 2023
 July 21, 2023/August 17, 2023
 August 25, 2023/September 21, 2023

September 19, 2023
 October 20, 2023 / November 16, 2023
 November 22, 2023 / December 21, 2023
 December 11, 2023 / January 18, 2024

+ Meeting Location & Time: 99 W. Main St. New Albany, OH 43054 at 4:00 PM.

* If you are unable to email, call 614-724-4437 to request alternative delivery options

**Meetings subject to cancellation and locations subject to change. Please contact staff to confirm. Meeting dates, times and locations are also available at www.columbus.gov/planning

^Date change due to holiday.

NOTE: For application deadlines that fall within the same week as the regular meeting date, a grace period of one (1) week is available for applications heard at the previous month's Hearing. (i.e. An application heard at the June Hearing may be granted the grace period to make any applicable revisions and apply for the July Hearing.)

The grace period does not apply to months with additional weeks whereby the application deadline naturally falls at least one (1) week after the regular meeting.

Legislation Number: PN0337-2022

Drafting Date: 11/17/2022

Version: 1

Current Status: Clerk's Office for Bulletin

Matter Type: Public Notice

Notice/Advertisement Title: Italian Village Commission 2023 Meeting Schedule

Contact Email Address: IVC@columbus.gov

It is the policy of the City of Columbus that all City-sponsored public meetings and events are accessible to people with disabilities. If you need assistance in participating in this meeting or event due to a disability as defined under the ADA, please call the City's ADA Coordinator at (614) 645-8871 or e-mail zdjones@columbus.gov at least three (3) business days prior to the scheduled meeting or event to request an accommodation.

Application Deadline^{^^} (IVC@columbus.gov < mailto:IVC@columbus.gov >)* (111 N. Front St. Hearing Rm. 204) (111 N. Front St. Hearing Rm. 204)	Business Meeting Date** 12:00p.m.	Hearing Date** 4:00p.m.
December 14, 2022	December 27, 2022	January 10, 2023
January 18, 2023	January 31, 2023	February 14, 2023
February 15, 2023	February 28, 2023	March 14, 2023
March 15, 2023	March 28, 2023	April 11, 2023
April 12, 2023	April 25, 2023	May 9, 2023
May 17, 2023	May 30, 2023	June 13, 2023
June 14, 2023	June 27, 2023	July 11, 2023
July 12, 2023	July 25, 2023	August 8, 2023

August 16, 2023
September 13, 2023
October 18, 2023
November 15, 2023
December 13, 2023

August 29, 2023
September 26, 2023
October 31, 2023
November 28, 2023
December 26, 2023

September 12, 2023
October 10, 2023
November 14, 2023
December 12, 2023
January 9, 2024

* If you are unable to email, call 614-724-4437 to request alternative delivery options

**Meetings subject to cancellation and locations subject to change. Please contact staff to confirm. Meeting dates, times and locations are also available at www.columbus.gov/planning

^Date change due to holiday.

NOTE: For application deadlines that fall within the same week as the regular meeting date, a grace period of one (1) week is available for applications heard at the previous month's Hearing. (i.e. An application heard at the June Hearing may be granted the grace period to make any applicable revisions and apply for the July Hearing.)

The grace period does not apply to months with additional weeks whereby the application deadline naturally falls at least one (1) week after the regular meeting.

Legislation Number: PN0338-2022

Drafting Date: 11/17/2022

Version: 1

Current Status: Clerk's Office for Bulletin

Matter Type: Public Notice

Notice/Advertisement Title: Historic Resource Commission 2023 Meeting Schedule

Contact Email Address: HRC@columbus.gov

It is the policy of the City of Columbus that all City-sponsored public meetings and events are accessible to people with disabilities. If you need assistance in participating in this meeting or event due to a disability as defined under the ADA, please call the City's ADA Coordinator at (614) 645-8871 or e-mail zdjones@columbus.gov at least three (3) business days prior to the scheduled meeting or event to request an accommodation.

Application Deadline^^
(HRC@columbus.gov)*
4:00p.m.

Business Meeting Date**
(111 N. Front St. Hearing Rm. 204)
12:00p.m.

Hearing Date**
(111 N. Front St. Hearing Rm. 204)
4:00p.m.

December 23, 2022
January 20, 2023
February 17, 2023
March 24, 2023
April 21, 2023
May 19, 2023
June 23, 2023
July 21, 2023
August 25, 2023
September 22, 2023

January 5, 2023
February 2, 2023
March 2, 2023
April 6, 2023
May 4, 2023
June 1, 2023
July 6, 2023
August 3, 2023
September 7, 2023
October 5, 2023

January 19, 2023
February 16, 2023
March 16, 2023
April 20, 2023
May 18, 2023
June 15, 2023
July 20, 2023
August 17, 2023
September 21, 2023
October 19, 2023

October 20, 2023
November 17, 2023
December 22, 2023

November 2, 2023
December 7, 2023
January 4, 2024

November 16, 2023
December 21, 2023
January 18, 2024

* If you are unable to email, call 614-724-4437 to request alternative delivery options

**Meetings subject to cancellation and locations subject to change. Please contact staff to confirm. Meeting dates, times and locations are also available at www.columbus.gov/planning

^Date change due to holiday.

NOTE: For application deadlines that fall within the same week as the regular meeting date, a grace period of one (1) week is available for applications heard at the previous month's Hearing. (i.e. An application heard at the June Hearing may be granted the grace period to make any applicable revisions and apply for the July Hearing.)

The grace period does not apply to months with additional weeks whereby the application deadline naturally falls at least one (1) week after the regular meeting.

Legislation Number: PN0339-2022

Drafting Date: 11/17/2022

Version: 1

Current Status: Clerk's Office for Bulletin

Matter Type: Public Notice

Notice/Advertisement Title: German Village Commission 2023 Meeting Schedule

Contact Email Address: GVC@columbus.gov

It is the policy of the City of Columbus that all City-sponsored public meetings and events are accessible to people with disabilities. If you need assistance in participating in this meeting or event due to a disability as defined under the ADA, please call the City's ADA Coordinator at (614) 645-8871 or e-mail zdjones@columbus.gov at least three (3) business days prior to the scheduled meeting or event to request an accommodation.

Application Deadline^^ (GVC@columbus.gov)* 4:00p.m.	Business Meeting Date** (111 N. Front St. Hearing Rm. 204) 12:00p.m.	Hearing Date** (111 N. Front St. Hearing earing HRm. 204) 4:00p.m.
December 8, 2022	December 21, 2022	January 4, 2023
January 5, 2023	January 18, 2023	February 1, 2023
February 2, 2023	February 15, 2023	March 1, 2023
March 9, 2023	March 22, 2023	April 5, 2023
April 6, 2023	April 19, 2023	May 3, 2023
May 11, 2023	May 24, 2023	June 7, 2023
June 8, 2023	June 21, 2023	July 5, 2023
July 6, 2023	July 19, 2023	August 2, 2023
August 10, 2023	August 23, 2023	September 6, 2023
September 7, 2023	September 20, 2023	October 4, 2023
October 5, 2023	October 18, 2023	November 1, 2023
November 9, 2023	November 22, 2023	December 6, 2023

December 7, 2023

December 20, 2023

January 3, 2024

* If you are unable to email, call 614-724-4437 to request alternative delivery options

**Meetings subject to cancellation and locations subject to change. Please contact staff to confirm. Meeting dates, times and locations are also available at www.columbus.gov/planning <<http://www.columbus.gov/planning>>

^Date change due to holiday.

NOTE: For application deadlines that fall within the same week as the regular meeting date, a grace period of one (1) week is available for applications heard at the previous month's Hearing. (i.e. An application heard at the June Hearing may be granted the grace period to make any applicable revisions and apply for the July Hearing.)

The grace period does not apply to months with additional weeks whereby the application deadline naturally falls at least one (1) week after the regular meeting.

Legislation Number: PN0340-2022

Drafting Date: 11/17/2022

Current Status: Clerk's Office for Bulletin

Version: 1

Matter Type: Public Notice

Notice/Advertisement Title: East Franklinton Review Board 2023 Meeting Schedule

Contact Email Address: efrb@columbus.gov

Meeting Accommodations: It is the policy of the City of Columbus that all City-sponsored public meetings and events are accessible to people with disabilities. If you need assistance in participating in this meeting or event due to a disability as defined under the ADA, please call the City's ADA Coordinator at (614) 645-8871 or e-mail zdjones@columbus.gov at least three (3) business days prior to the scheduled meeting or event to request an accommodation.

Application Deadline^^ (efrb@columbus.gov)*	Business Meeting** (111 N. Front St., Rm #204) 12:00pm	Regular Meeting** (111 N. Front St. Rm. #204) 3:00pm
December 29, 2022	January 11, 2022	January 25, 2023
January 26, 2023	February 8, 2022	February 22, 2023
February 23, 2023	March 8, 2022	March 22, 2023
March 30, 2023	April 12, 2022	April 26, 2023
April 27, 2023	May 10, 2022	May 24, 2023
June 1, 2023	June 14, 2022	June 28, 2023
June 29, 2023	July 12, 2022	July 26, 2023
July 27, 2023	August 9, 2022	August 23, 2023
August 31, 2023	September 13, 2022	September 27, 2023
September 28, 2023	October 11, 2022	October 25, 2023
November 2, 2023^	November 15, 2022^	November 29, 2023^
November 30, 2023^	December 6, 2022^	December 20, 2023^

* If you are unable to email, call 614-724-4437 to request alternative delivery options

**Meetings subject to cancellation. Please contact staff to confirm. Meeting dates, times and locations are also available at www.columbus.gov/planning

^Date change due to holiday.

NOTE: For application deadlines that fall within the same week as the regular meeting date, a grace period of one (1) week is available for applications heard at the previous month's Hearing. (i.e. An application heard at the June Hearing may be granted the grace period to make any applicable revisions and apply for the July Hearing.) The grace period does not apply to months with additional weeks whereby the application deadline naturally falls at least one (1) week after the regular meeting.

Legislation Number: PN0341-2022

Drafting Date: 11/17/2022

Current Status: Clerk's Office for Bulletin

Version: 1

Matter Type: Public Notice

Notice/Advertisement Title: Downtown Commission 2023 Meeting Schedule

Contact Name: Luis Teba

Contact Telephone Number: 614-645-8062

Contact Email Address: DC@columbus.gov

Meeting Accommodations: It is the policy of the City of Columbus that all City-sponsored public meetings and events are accessible to people with disabilities. If you need assistance in participating in this meeting or event due to a disability as defined under the ADA, please call the City's ADA Coordinator at (614) 645-8871 or e-mail zdjones@columbus.gov at least three (3) business days prior to the scheduled meeting or event to request an accommodation.

Application Deadline (DC@columbus.gov) *	Business Meeting** (111 N. Front St., Rm #204) 8:30am	Regular Meeting** (111 N. Front St. Rm. #204) 8:30am
December 28, 2022	January 10, 2023	January 24, 2023
February 1, 2023	February 14, 2023	February 28, 2023
March 1, 2023	March 14, 2023	March 28, 2023
March 29, 2023	April 11, 2023	April 25, 2023
April 26, 2023	May 9, 2023	May 23, 2023
May 31, 2023	June 13, 2023	June 27, 2023
June 28, 2023	July 11, 2023	July 25, 2023
July 26, 2023	August 8, 2023	August 22, 2023
August 30, 2023	September 12, 2023	September 26, 2023
September 27, 2023	October 10, 2023	October 24, 2023
November 1, 2023	November 14, 2023	November 28, 2023
November 22, 2023	December 5, 2023	December 19, 2023^

* If you are unable to email, call 614-724-4437 to request alternative delivery options

**Meetings subject to cancellation. Please contact staff to confirm.

^Date change due to holiday.

NOTE: For application deadlines that fall within the same week as the regular meeting date, a grace period of one (1) week is available for applications heard at the previous month's Hearing. (i.e. An application heard at the June Hearing may be granted the grace period to make any applicable revisions and apply for the July Hearing.)

The grace period does not apply to months with additional weeks whereby the application deadline naturally falls at least one (1) week after the regular meeting.

Legislation Number: PN0342-2022

Drafting Date: 11/17/2022

Current Status: Clerk's Office for Bulletin

Version: 1

Matter Type: Public Notice

Notice/Advertisement Title: Columbus Art Commission 2023 Hearing and Application Schedule

Contact Name: Lori Baudro

Contact Telephone Number: 614.645.6986 (o)

Contact Email Address: lsbaudro@columbus.gov

Meeting Accommodations: It is the policy of the City of Columbus that all City-sponsored public meetings and events are accessible to people with disabilities. If you need assistance in participating in this meeting or event due to a disability as defined under the ADA, please call the City's ADA Coordinator at (614) 645-8871 or e-mail zdjones@columbus.gov at least three (3) business days prior to the scheduled meeting or event to request an accommodation.

Application Deadline **Hearing Dates****
(lsbaudro@columbus.gov)*

December 22, 2022	January 18, 2023
January 19, 2023	February 15, 2023
February 16, 2023	March 15, 2023
March 23, 2023	April 19, 2023
April 20, 2023	May 17, 2023
May 25, 2023	June 21, 2023
June 22, 2023	July 19, 2023
July 20, 2023	August 16, 2023
August 24, 2023	September 20, 2023
September 21, 2023	October 18, 2023
October 19, 2023	November 15, 2023
November 23, 2023	December 20, 2023
December 21, 2023	January 17, 2024

Hearings are held in-person in room 204 at the Coleman Government Center, 111 N. High Street, Columbus, OH 43215 and the start time will be **5:30 PM**. Staff should be contacted before an application and materials are submitted electronically. Hard copy submissions are no longer needed.

* If you have questions call 614.645.6986 (o).

**Meetings subject to cancellation and locations subject to change. Please contact staff to confirm. Meeting dates, times and locations are also available at www.columbus.gov/planning

Legislation Number: PN0343-2022

Drafting Date: 11/17/2022

Current Status: Clerk's Office for Bulletin

Version: 1

Matter Type: Public Notice

Notice/Advertisement Title: Brewery District Commission 2023 Meeting Schedule

Contact Email Address: BDC@columbus.gov

It is the policy of the City of Columbus that all City-sponsored public meetings and events are accessible to people with disabilities. If you need assistance in participating in this meeting or event due to a disability as defined under the ADA, please call the City's ADA Coordinator at (614) 645-8871 or e-mail zdjones@columbus.gov at least three (3) business days prior to the scheduled meeting or event to request an accommodation.

Application Deadline^^ (BDC@columbus.gov)* 4:00p.m.	Business Meeting Date** (111 N. Front St. Hearing Rm. 204) 12:00p.m.	Hearing Date** (111 N Front St. Hearing Rm 204) 4:00p.m.
December 9, 2022	December 22, 2022	January 5, 2023
January 6, 2023	January 19, 2023	February 2, 2023
February 3, 2023	February 16, 2023	March 2, 2023
March 10, 2023	March 23, 2023	April 6, 2023
April 7, 2023	April 20, 2023	May 4, 2023
May 5, 2023	May 18, 2023	June 1, 2023
June 9, 2023	June 22, 2023	July 6, 2023
July 7, 2023	July 20, 2023	August 3, 2023
August 11, 2023	August 24, 2023	September 7, 2023
September 8, 2023	September 21, 2023	October 5, 2023
October 6, 2023	October 19, 2023	November 2, 2023
November 10, 2023	November 16^, 2023	December 7, 2023
December 8, 2023	December 21, 2023	January 4, 2024

* If you are unable to email, call 614-724-4437 to request alternative delivery options

** Meetings subject to cancellation and locations subject to change. Please contact staff to confirm. Meeting dates, times and locations are also available at www.columbus.gov/planning. The Hearing time will change to 4:00 p.m. beginning in July 2020.

^Date change due to holiday

NOTE: For application deadlines that fall within the same week as the regular meeting date, a grace period of one (1) week is available for applications heard at the previous month's Hearing. (i.e. An application heard at the June Hearing may be granted the grace period to make any applicable revisions and apply for the July Hearing.)

The grace period does not apply to months with additional weeks whereby the application deadline naturally falls at least

one (1) week after the regular meeting.

Legislation Number: PN0344-2022

Drafting Date: 11/17/2022

Version: 1

Current Status: Clerk's Office for Bulletin

Matter Type: Public Notice

Notice/Advertisement Title: Big Darby Accord Advisory Panel 2023 Schedule

Contact Email Address: planninginfo@columbus.gov

Meeting Accommodations: It is the policy of the City of Columbus that all City-sponsored public meetings and events are accessible to people with disabilities. If you need assistance in participating in this meeting or event due to a disability as defined under the ADA, please call the City's ADA Coordinator at (614) 645-8871 or e-mail zdjones@columbus.gov at least three (3) business days prior to the scheduled meeting or event to request an accommodation.

Application Deadline^^
(planninginfo@columbus.gov)*

Hearing Date**
(Franklin County Courthouse)+
1:30PM

December 12, 2022
January 16, 2023
February 13, 2023
March 13, 2023
April 10, 2023
May 15, 2023
June 12, 2023
July 10, 2023
August 14, 2023
September 11, 2023
October 16, 2023
November 13, 2023

January 10, 2023
February 14, 2023
March 14, 2023
April 11, 2023
May 9, 2023
June 13, 2023
July 11, 2023
August 8, 2023
September 12, 2023
October 10, 2023
November 14, 2023
December 12, 2023

+ Meeting location: 373 S. High St., 25th Fl. - Room B

* If you are unable to email, call 614-724-4437 to request alternative delivery options

**Meetings subject to cancellation and locations subject to change. Please contact staff to confirm. Meeting dates, times and locations are also available at www.columbus.gov/planning

^^Date change due to holiday.

NOTE: For application deadlines that fall within the same week as the regular meeting date, a grace period of one (1) week is available for applications heard at the previous month's Hearing. (i.e. An application heard at the June Hearing may be granted the grace period to make any applicable revisions and apply for the July Hearing.)

The grace period does not apply to months with additional weeks whereby the application deadline naturally falls at least one (1) week after the regular meeting.

Legislation Number: PN0369-2022

Drafting Date: 12/7/2022

Version: 1

Current Status: Clerk's Office for Bulletin

Matter Type: Public Notice

Notice/Advertisement Title: Board of Industrial Relations

Contact Name: William Gaines

Contact Telephone Number: 614-645-5436

Contact Email Address: wgaines@columbus.gov

The Board of Industrial Relations holds regular meetings on the 3rd Monday of each month at 1:30pm in Room #205, 111 N. Front St., Columbus Ohio. Due to observed holidays, the January meeting will be held on January 23, 2023 at 1:30pm, the February meeting will be held on February 27, 2023 at 1:30pm and the June meeting will be held on June 26, 2023 at 1:30pm.

Legislation Number: PN0377-2022

Drafting Date: 12/14/2022

Version: 1

Current Status: Clerk's Office for Bulletin

Matter Type: Public Notice

Notice/Advertisement Title: Land Review Commission 2023 Schedule

Contact Name: Mark Lundine

Contact Telephone Number: 614-645-1693

Contact Email Address: malundine@columbus.gov

The following scheduled Land Review Commission meetings are subject to cancellation. Please contact a staff member to confirm.

111 N. Front St., Hearing Room 204

Columbus, OH 43215

9:00am

January 19

February 16

March 16

April 20

May 18

June 15

July 20

August 17

September 21

October 19

November 16

December 21

Meeting Accommodations: It is the policy of the City of Columbus that all City-sponsored public meetings and events are accessible to people with disabilities. If you need assistance in participating in this meeting or event due to a disability as defined under the ADA, please call the City's ADA Coordinator at (614) 645-8871 or e-mail zdjones@columbus.gov at least three (3) business days prior to the scheduled meeting or event to request an accommodation.

